

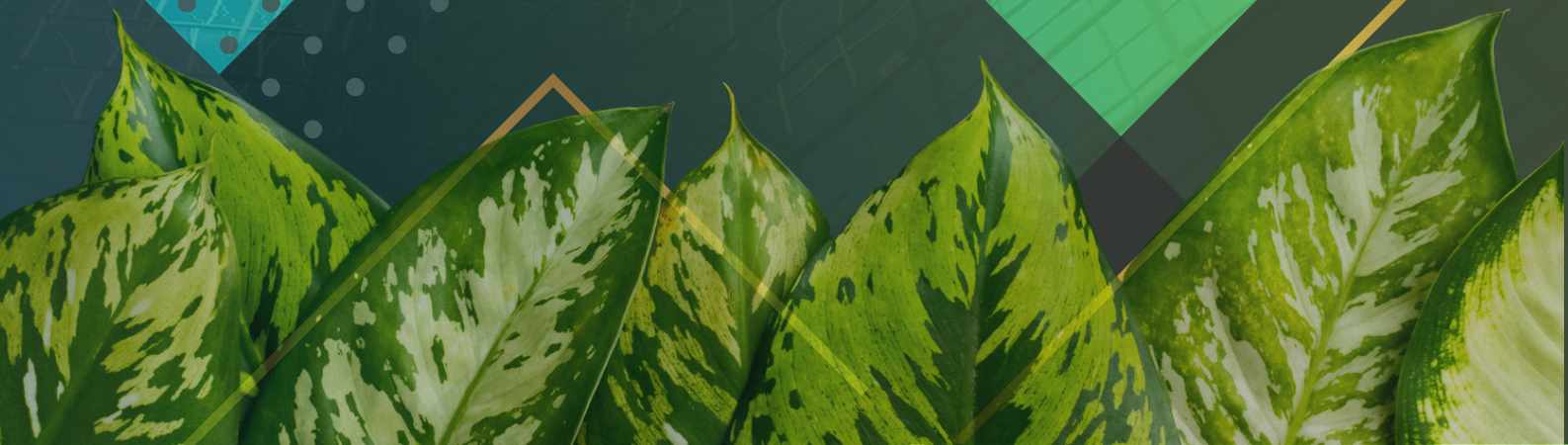

# E-PROCEEDING HOTWEC 7.0

**SUSTAINABLY NURTURING  
TOURISM,  
HOSPITALITY AND WELLNESS INDUSTRY  
FOR A BRIGHTER TOMORROW**







# E-PROCEEDING HOTWEC 7.0

**SUSTAINABLY NURTURING  
TOURISM,  
HOSPITALITY AND WELLNESS INDUSTRY  
FOR A BRIGHTER TOMORROW**

Copyright UMK Press, 2023

All rights reserved. No part of this publication may be reproduced, stored in production transmitted in any form, whether electronic, mechanical, photocopying, recording or otherwise, without having permission from the UMK Press.

Perpustakaan Negara Malaysia Cataloguing-in-Publication Data

Title: E-Proceeding Hotwec 7.0 Sustainably Nurturing Tourism, Hospitality and Wellness Industry For A Brighter Tomorrow

e-ISBN: 978-629-489-007-7

Published by:

UMK Press

Universiti Malaysia Kelantan

Office of Library and Knowledge Management

16300 Bachok

Kelantan

(Member of Malaysian Scholarly Publishing Council (MAPIM))

(Member of Malaysian Book Publishers Association (MABOPA))

Membership Number: 201903)

In Collaboration:

Faculty of Hospitality, Tourism and Wellness Universiti Malaysia Kelantan (UMK), Kampus Kota Pengkalan Chepa, 16100 Kota Bharu Kelantan, Malaysia.

<b>Title</b>	<b>Page</b>
<b>Prefece</b>	<b>i</b>
<b>Acknowledgement</b>	<b>ii</b>
Consumer Acceptance of Innovation In Traditional Foods Among Undergraduates' Student	1
The Study on Visitor's Acceptance Of Traditional Malay Food In Malaysia	15
The Study on Tourist Visit Intention Theme Park in Malaysia	29
Factors that influence customer satisfaction in 3star hotels in Kelantan	46
Factors that influence customers satisfaction towards robotic service restaurant in Malaysia	65
The Viral Marketing Role In Directing Customer Purchasing Decision Regarding Food In Tiktok	85
Factors Influencing The Usage Of Online Food Delivery Service Among University Student In Malaysia	104
Measuring Perceived Service Quality Toward Customers Loyalty In Malaysia Fast Food Restaurant	121
The Influencing Factors Of Online Reviews Affecting Customer Visit Intention Towards Food And Beverage Establishment In Malaysia	141
The Influence of Workplace Deviant Behavior Towards Employee Performance in Malaysia Hotel Industry	159
Customer Satisfaction and Willingness to Use Self-Service Kiosk In Genting Highlands Hotel	176
The Influences of Hygiene Attributes Toward Customers' Fear of Covid at Thai Restaurant in Kota Bharu, Kelantan	189
The Antecedent of Brand Love Toward Starbuck in Kuala Lumpur	202
Factors That Influence Customers Satisfaction Toward Fast Food Restaurant In Kota Bharu	214
Intention To Eat Kelantan Traditional Food Among UMK Students At City Campus	222
Customer Satisfaction Towards Service Quality In The Fast-Food Industry At Kota Bharu, Kelantan	243
Student's Behavior Towards Fast Food Restaurant At Universiti Malaysia Kelantan (City Campus)	262
The Acceptance of Street Food Among University Students in Universiti Malaysia Kelantan, City Campus	278
Factors Affecting Consumer Preference To Use Online Food Delivery Services In Malaysia	295
The Influence of Youngster's Satisfsaction Towards Hipster Food in Kota Bharu, Kelantan	310
Factors Influencing Visitors Motivations in Attending Food Festival in Malaysia	328
Factors That Influencing Customer's Satisfaction Toward Food Trucks in Kota Bharu, Kelantan	342
Consumer Perception of Food Safety at Restaurant in Kota Bharu, Kelantan	354



Consumer Knowledge, Perception Of Food Image And Acceptance Towards Kelantan Traditional Food	367
Factor Influencing Customer Satisfaction Among Millennials Toward Homegrown Cafe In Kota Bharu	384
Factors Affecting Student Satisfaction to Visit Cafeteria at University Malaysia Kelantan, Bachok	395
Measuring Eco - Tourist Perception, Knowledge, Acceptance And Revisit Intention In Malaysia	408
The Role of Service, Restaurant Environment, Food Quality, Food Hygiene, and Food Pricing Toward Customer Satisfaction On Fast Food Restaurant	428
The Role of Customer Attribute On Customer Satisfaction Toward Restaurant In Kelantan	443
Study of Workplace Environment, Reward and Recognition on Job Satisfaction Among Employees' Malaysian Hotel Industry	455
The Factors That Have Influenced Final Year Students' University Malaysia Kelantan In Pursuing A Career In The Hospitality Industry	470
Customer Satisfaction Of The Airlines In Sultan Ismail Petra Airport, Kota Bharu Kelantan	485
Customer Perception Of Mcdonald's Restaurant Service Quality In Kota Bharu Kelantan	500
The Factors That Affect Customer Satisfaction in Hotels at Kota Bharu, Kelantan	513
University Students Perception Towards Hipster Café In Kota Bharu, Kelantan	525
Factors That Motivate University Malaysia Kelantan's Students To Participate In Cultural Tourism Activities	552
Examining The Perceptions Of Tourism Employees Towards Government Policies For Covid-19 Recovery Process	566
The Factors Determine Food Satisfaction Among Domestic Tourists : The Case Of Gastronomic Tourism In Kelantan	572
The Factors Determine Satisfaction Among Tourist Visiting Sustainable Heritage Tourism Development In Kelantan	592
The Relationship Between Memorable Experience, Travel Satisfaction, and Tourist Expectation on Revisit Intention Among Tourist in Malaysia	611
The Relationship Between Accommodation, Food Quality, and Customer Relations Towards Tourist Satisfaction in Malaysia	627
The Factors Influence Employee Satisfaction Employee Satisfaction In The Hotel Industry	649
The Factors that Influence Tourism Demand in Malaysia	673
Factor Influencing Tourist Satisfaction While Traveling Among Students At Universiti Malaysia Kelantan	692
Factors Determining Young Tourists' Intention To Use	709

Smart Tourism Technology In Kelantan	
Factor That Builds Youth's Intention To Do Adventure Tourism In Kelantan	731
Factors Influencing Intention To Use Smart Mobile Apps Among Local Traveller In East Coast Malaysia	744
The Factors That Influence The Malay Community In The Use Of Accommodation Technology Applications In Kota Bahru, Kelantan	759
Impacts Of Ecotourism Development Toward Quality Of Life Among Local Communities In Dabong, Kelantan	774
Factors That Influence the Increasing Of Stress Among Wellness Student Year 2 In Universiti Malaysia Kelantan, Kampus Kota	791
Perception Of Kuala Terengganu As An Islamic Tourism Destination Among The People That Had Been In Kuala Terengganu	801
The Effect Of Perceived Impact, Social Impact And Environmental Impact On Tourism Development In Sabah, Malaysia Among Indigenous People	822
Analysis Of The Impact On Halal Tourism Towards Tourism Students At Universiti Malaysia Kelantan	835
The Effectiveness of Technology Use Among Tourist Satisfaction in Kelantan	852
Factors Influencing Visitor's Awareness Level And Visitor's Satisfaction Level Towards Safety In Tok Bali, Kelantan	876
The Effect Of Destination Attributes On Tourist Loyalty Aftermath Of The Crisis	900
Exploring Innovation In The Homestay Program	915
Exploring The Potential Of Staycation Making To Travel During And Aftermath Of The Covid-19	930
The Effect Of A Short Vacation On Work Stress Among Tourism Lecturers	944
The Impact Of Memorable Eco-Tourism Experience On Behavioral Intention Among Tourists Who Took Train Trips To Dabong, Kelantan	959
Impact of Event Experience Towards Satisfaction Among E-Sport Events Participant	971
Investigation Of Bundle Event And Visitor Satisfaction A Case Of Bundle Event	985
Factors Influence Kelantan Experience Tourism Among Umk Students	1002
Factors Encouraging Women Participation in Tourism	1018
Intention To Use Metaverse In Teaching Among Universiti Malaysia Kelantan Lecturer	1048
The Relationship Between Adaptive Capacity And Business Performance Among Homestay Operators In Kelantan	1057
Factors That Motivate Student's Willingness To Involve In Volunteer Tourism Programs In Malaysia	1067
The Effect Of Interpersonal Skills Attributes Towards	1087

Motivation To Volunteer Among Youth In Kelantan	
Understanding Success Factor Strengthen Min House Camp As A Community-Based Tourism Product In Kelantan During Post-Covid	1101
Factors Influencing Revisit Intention of Community-Based Tourism in Tok Bali, Kelantan; Tourist Perspective	1122
The Impact Of Service Quality Airqual Model Towards Malaysia Airlines Customers' Satisfaction	1143
A Study on Tourist Satisfaction Towards Ferry Services in Langkawi	1161
Examining Customer Satisfaction Toward Quality Service at Zamburger Hotel: A Quantitative Study	1173
Understanding The Effectiveness of Marketing Communication Towards Tourist Decision-Making to Visit Min House Camp	1188
Factor Affecting Tourist Development In Kelantan After Covid-19	1202
The Factors Influencing The Tourism Development In Genting Highland	1221
The Factors Influencing Tourist Visitation Among Tourists A Case Study In Kelantan, Malaysia	1235
Factor Influencing The Development In Kota Bharu, Kelantan	1254
The Influence Of Smart Tourism Applications On Perceived Destinations Image In Kelantan	1271
Factors Affecting Gen Y Tourists' Purchase Intention Towards Local Food In Kelantan	1284
Factors That Influence Tourists' Intention To Consume Local Food In Kelantan	1296
Push And Pull Factors Of Tourist Participate In Outdoor Adventure Tourism	1310
Factors Influence Tourists' Selecting Melaka As Holiday Destination	1323
Tourist Satisfaction Towards Local Heritage Food In Pulau Pinang	1331
The Factors That Affect Customer Satisfaction On The Quality Of Hotel Service	1339
The Factors Of Selecting Langkawi Island As A Tourist Destinantion: A Conceptual Paper	1347
Factor Affecting Memorable Tourism Experiences Towards Behavioural Intentions of Heritage Tourists	1357
Re-Visiting Community-Based Tourism Intention in Kelantan Malaysia: Insights for Tourists	1367
The Nexus Of Information And Communication Technology (Ict) And Sustainable Tourism Marketing Among Owner's Homestay	1381
Issues Influencing the Use of Smart Tourism Apps Among Malaysia Tourism Stakeholders	1399
A Study of Tourist Satisfaction of Cross-Border Tourism Development in Rantau Panjang, Kelantan	1415



Factors Influencing Destination Loyalty Among Domestic Tourist In Perhentian Island, Terengganu, Malaysia	1434
Factors Influencing the Supply of Pineapples in Johor, Malaysia	1447
Tourist Satisfaction Towards Beach Tourism In Pantai Cahaya Bulan Kota Bharu, Kelantan	1462
Awareness and Knowledge of Social Protection Among Gig Economy Workers in Kota Bharu, Kelantan	1471
Awareness and Knowledge of Right To Disconnect After Work Among Lecturers In University Malaysia Kelantan (KOTA)	1485
Awareness and Knowledge of Academic Burnout Among Students in University Malaysia Kelantan Kampus Kota: A Qualitative Study	1500
Political Awareness And Knowledge Among Student In University Malaysia Kelantan	1539
Factors Influencing Green Restaurant Revisit Intention Among Consumers in Malaysia	1549
Factor Influencing Online Repurchase Intention Among Cosmetic Consumers In Malaysia	1561
Determinants of Consumers Purchase Intention Towards Organic Beauty Products Among Women in Malaysia	1577
Motivational Factors to Consume Organic Food Products Among University Students' in Kelantan	1596
The Exploring Study of Postpartum Depression Prevalence Among Women in Kelantan	1610
The Effect Of Online Gaming On Mental Health, Finance And Academic Performance Among University Student	1624
The Factors Influencing Nurses Mental Health In Hospital Raja Perempuan Zainab II (HRPZ II)	1632
Fast Food Consumption Among Teenagers in Pengkalan Chepa	1653
Customer Satisfaction With Traditional & Complementary Medicine Among Community in Pengkalan Chepa, Kelantan	1665
Unhealthy Lifestyle Among Youth in Kedah And Johor	1682
The Factors That Influence Sleep Quality Among Students Universiti Malaysia Kelantan (UMK), City Campus	1693
Mental Health Among Students of the Universiti Malaysia Kelantan, Kampus Kota	1709
The Factor That Influence the Daily Diet among Wellness Student in Universiti Malaysia Kelantan, Kampus Kota	1716
Weight Management of Obesity Among Student In Universiti Malaysia Kelantan	1732
Factors Affecting Stress Among First-Year Students Fakulti Hospitaliti, Pelancongan & Kesejahteraan (FHPK) At Universiti Malaysia Kelantan	1748
Factors Influencing Fast-Food Consumption Among Students at Universiti Malaysia Kelantan, City Campus	1760
Factors Influencing Eating Habits among Wellness Students at Universiti Malaysia Kelantan	1775

Factor Affecting Mental Health Among 3rd Year Student at University Malaysia Kelantan, City Campus	1788
Identifying The Challenges and The Level of Effectiveness of Campus Wellness Initiatives Among Students and Staff in UMK City Campus	1801
Assessing The Post-Service Experience Towards Emotional Impacts On Spa-Goers in Kota Bharu, Kelantan	1816
Exploring Success Factors Influencing The Effectiveness of Wellness Initiatives Activities in The University	1834
Customer Satisfaction with Traditional and Complementary Medicine (TCM) Services	1850
Adopting A Healthy Lifestyle: It's A Choice	1860
The Involvement in Physical and Fitness Activities Among Community in Malaysia	1872
Preferences of Fast-Food Selection Among Third-Year Students of Bachelor Entrepreneurship (Wellness) with Honour at UMK City Campus	1884
Unhealthy Lifestyle Factors Among Wellness Students at UMK City Campus	1896
Student's Motivation After Returning to University Malaysia Kelantan City Campus	1910
The Association Between Family Values and Coping Skills Toward Depression Among 3U11 Students	1923
Relationship Between Traditional Postnatal Care Services Utilization and Emotional Status Among Women	1936
The Association Between Parental Emotional Styles and Emotional Problems Among Preschool Children	1946
Factors Influencing the Demand for Halal Foods Purchase Intention in Kelantan	1959
Determinants of Purchase Intention of Online Shopping Platforms	1980
Factors Influencing the Intention to Use Fitness Apps Among Generation Z	2004
Fast Food Consumption Among University Students: A Comparative Study Between University Malaysia Kelantan (UMK) Pengkalan Chepa and Institut Pendidikan Guru (IPG) Students	2037
The Factors That Influence Physical Activity Involvement Among Universiti Malaysia Kelantan (UMK) Kampus Kota Students	2051

# PREFACE

In the dynamic landscape of today's global economy, the fields of tourism, hospitality, and wellness are experiencing unprecedented growth and evolution. This compendium represents a convergence of innovation and academic rigor, providing a platform for students to showcase their scholarly contributions. E-proceedings encapsulate a collection of research projects, and insights that underscore the diverse dimensions of tourism, hospitality, and wellness. It is a testament to the curiosity, dedication, and intellectual prowess of our undergraduate scholars. In the pages that follow, readers will find a rich tapestry of research articles that reflect the tourism, hospitality, and wellness disciplines.

Students, lecturers, and industry partners collaborative efforts signify a commitment to advancing knowledge and fostering a community of learners who are well-equipped to navigate the complexities of the modern tourism, hospitality, and wellness sectors. May this collection inspire further exploration, dialogue, and innovation among the next generation of leaders in these dynamic fields.

Therefore, this book summarizes the selected papers of student conference focused on the current issues in tourism, hospitality and wellness field. Presented papers deal with investigation of issues and challenges of tourism, hospitality and wellness to make the industries more sustainable and adapt with the changes in the environment. Presented paper bring a wide database of issues and challenges in the field which could be used in the future researcher and industries players in the future.

Ataul Karim Patwary, PhD

Muhamad Nasyat Muhamad Nasir, PhD

Nurul Aziah Binti Ahmad

Mohd Firdaus Bin Mohd Nasir



# ACKNOWLEDGEMENT

It is our pleasure to present this volume consisting of selected papers based on presentations from the Hospitality, Tourism and Wellness Colloquium 7.0, held on May 28 and 29, 2023 at the Universiti Malaysia Kelantan. The main colloquium objective is to explore, within the generative framework, different acquisition contexts, across a variety and between different components of the Hospitality, Tourism and Wellness fields. The colloquium was organized and supported by the Faculty of Hospitality, Tourism and Wellness (FHPK), Universiti Malaysia Kelantan (UMK). We would also like to extend our gratitude to the excellent work of our colloquium organizing committee which comprised of the following:

Roslizawati Binti Che Aziz, PhD

Khairil Wahidin Bin Awang, PhD

Mohd Fadil Bin Mohd Yusof, PhD

Hasif Rafidee Bin Hasbollah, PhD

Ruzanifah Binti Kosnin, PhD

Ahmad Fahme Bin Mohd Ali, PhD

Nik Alif Amri Bin Nik Hashim, PhD

Nurul Hafizah Binti Mohd Yasin, PhD

Derweanna Binti Bah Simpong, PhD

Normaizatul Akma Binti Saidi, PhD

Nor Dalila Binti Marican, PhD

Marlisa Binti Abdul Rahim, PhD

Nur Hafizah Binti Muhammad, PhD

Siti Fatimah Binti Ab Ghaffar, PhD

Aifa Rozaini Binti Mohd Radzol, PhD

Suchi Binti Hassan, PhD

Siti Salina Binti Saidin, PhD

Aikal Liyani Binti Mohd Rasdi, PhD

Nur Dalila Binti Mat Yusoff, PhD

Nor Syuhada Binti Zulkefli, PhD

Muhamad Nasyat Bin Muhamad Nasir, PhD

Ataul Karim Patwary, PhD

Adeneye Yusuf Babatunde, PhD

Norizan Binti Musa, PhD

Mohd Hakam Bin Nazir, PhD  
Nur Ida Fatihah Binti Che Shalifullizam, PhD  
Norsyamlina Binti Che Abdul Rahim, PhD  
Norsuriani Binti Samsudin, PhD  
Nur Farihin Binti Abd Hadi Khan  
Mohd Firdaus Bin Mohd Nasir  
Mazne Binti Ibrahim  
Raja Norliana Binti Raja Omar  
Nurul Aziah Binti Ahmad  
Hazzyati Binti Hashim  
Mohd Hafzal Bin Abdul Halim  
Nor Maizana Binti Mat Nawi  
Zaimatul Binti Awang  
Fauzan Hafiz Bin Muhammad Safri  
Fadhilahanim Aryani Binti Abdullah  
Abdullah Bin Muhamed Yusoff  
Mohammed Ruqaimi Bin Remeli  
Ahmad Faezi Bin Ab. Rashid  
Nursalihah Binti Ahmad Raston  
Harnidah Binti Samengon  
Nor Amira Binti Mohd Razali  
Siti Selihah Binti Che Hasan  
Nurzehan Binti Abu Bakar  
Nurul Fardila Binti Abd Razak  
Nur Azimah Binti Othman  
Muhammad Firdaus Bin Bidin

We would also like to acknowledge the excellent work of our conference reviewers of the original abstracts and the papers submitted for consideration in this volume for having so generously shared their time and expertise. Along with these individuals, we wish to thank our local colleagues and students who contributed greatly to the organization and success of the colloquium.

# CONSUMER ACCEPTANCE OF INNOVATION IN TRADITIONAL FOODS AMONG UNDERGRADUATES' STUDENT

Ahmad Rashdan Bin Rozman, Ainnu Natasha Binti Mat Zais, Ainul Athirah Binti Mat Nudin  
Amni Binti Abd Azis & Derweanna Bah Simpong

*Faculty of Hospitality, Tourism, and Wellness, University Malaysia Kelantan  
Corresponding email: derweanna@umk.edu.my*

---

## ABSTRACT

The study examines consumer acceptance of innovation in traditional foods among undergraduate students and finds out the relationship between knowledge, attitude, and practice of consumer acceptance. A survey with 390 participants who eat traditional Malay food was carried out applying questionnaires. The data was examined using descriptive and correlational analysis. Findings showed that perception had the least link with customer acceptability whereas the three factors strongly connected to attitude had the largest relationship. Future researchers were given implications and suggestions based on the findings.

**Keywords: Consumer Acceptance, traditional food innovation, knowledge, attitude, Undergraduates students**

---

## INTRODUCTION

Malaysia was known for its cultural, ethnic, and spiritual diversity. According to Ismail (2021), Malaysia's cultural inheritance is authentic, original, and colorful, with numerous national cuisines of different tribes in the country. As a result, Malaysians may be fairly proud of their diverse gastronomic offerings. A traditional food item, in Bertozzi's words, "represents a group, it belongs to a certain region, and it is a component of a culture that suggests the person's involvement in that territory" (1998). (Jordana,2000) derived the following from this sociological definition: "For a product to be considered traditional, it must be linked to an area and also, be a part of a system of traditions, which will necessarily assure its continuance through time."

Traditional food around the world is strongly anchored in local cultures, constituting the culinary heritage of a nation or a region and contributing to its identity and pride (Licitra, 2010; Bessièrè, 1998). An expression of this is that national and regional traditional foods are unfailingly served to foreign visitors, as a way to let guests learn to know their hosts through



culinary traditions. Dimensions of culinary heritage and rationality are the basis for the definition of Traditional Food Products (TFPs) from professional perspectives. Malay traditional food may be classified generally based on area. Penang, Perlis, and Kedah have a fiery scorching hot and bitter flavor. (2016) (Muhammad et al.). For example, laksa was a popular dish in the northern states. Rahman (2010) identifies Gulai Tempoyak and rendang as two characteristic traditional dishes typically served in Perak and Pahang for routine meals or festival festivities.

Innovation is a continuous process of learning, searching, and exploring that leads to new goods, processes, organizational structures, and markets (Lundvall, 1995). The three phases of attempts, actions, and outcomes make up the continual process of innovation. Resources that a company invests in activities for the creation of innovations include human and financial resources. These efforts are all resources. Results include the impacts of these innovative efforts on both more and less visible parts of the business, such as firm stability and efficiency (Gellynck et al., 2006) as well as more and less visible aspects, such as increase of market share and profit. Malaysian traditional food consumption was quickly falling in this period of globalization due to technological improvements. In order to improve traditional food in ways that are comparable to non-traditional food, Dogan (2015) states that traditional food innovations must maintain the natural food identity of those products, such as usual, familiar, authentic, typical, and inherited. It was challenging for Malaysian cuisine to distinguish itself as a distinct subgroup of traditional foods. Ismail (2013) asserts that advances in technology and the appearance of pre-made commodities have led to a radical reversal in the way traditional Malay food is prepared on a big scale.

Undergraduate students were selected for this research. This study discusses consumer acceptance among undergraduate students toward innovation in traditional food. Undergraduate students occur after high school and before postgraduate study. Students typically begin undergraduate studies at the age of eighteen, however, you can apply at any time. An honours degree is the most common undergraduate qualification; it is frequently the first degree a student studies and is the highest qualification that can be obtained at this level. (Paul Ellet,2019).

There are three objectives of this research:

1. To investigate the relationship between knowledge and consumer acceptance of traditional food innovation.
2. To investigate the relationship between attitudes and consumer acceptance of traditional food innovation.
3. To investigate the relationship between practice and consumer acceptance of traditional food innovation.

### **Significance of the Study**

### **Researchers**

This research will give information about traditional cuisines. It will also illustrate how undergraduate students' knowledge, attitude, and practise may influence customer acceptance of conventional food innovation. Because the students are of many races and each ethnic group has its own eating tradition, this research will assist the next student in learning more about the invention of traditional food. The information gathered may assist readers in determining the percentage of consumers who embrace innovative traditional foods.

### **LITERATURE REVIEW**

Traditional food is a representation of the cultures, histories, and customs passed down through generations, as well as a progression in culinary taste. Trichopoulou et al. Year after year, the traditional food of Malaysia's multi-ethnic cultures was integrated in novel ways across the country, resulting in the development of a distinct Malaysian traditional identity. Salleh (2006). In order to stay competitive and satisfy consumer wants, the food business is always creating new food products. Increasing production efficiency, expanding their product line, cultivating a reputation as an innovative company that benefits their brand, or adhering to national nutritional policies and guidelines regarding the safety and healthiness of food products, For example, salt reduction in processed foods may be one of the primary drivers of food company innovation (Henard & Dacin, 2010). Legowski and Legetic (2011), Pietinen et al. (2008), Wyness, Butriss, and Stanner (2012).

KAP stands for typical area resident research, which focuses on learning what is understood, held to be true, and is being done with regard to a particular subject. Yang, Wang, Kan, Wu, Maddock, and Lu (2015).

### **Knowledge**

Personal development requires knowledge, awareness, recognition, and application. The development of knowledge will be aided by prior knowledge of the same themes (Nasimi et al., 2013). Taking students' acceptance of traditional food's innovation as an example. To perform something, someone needs to have a little knowledge as a foundation to remember the information (Francis, 1995). Francis (1995) stated that in order to retain knowledge easily, you must always practice it in practice. When people remember information in an indirect way, they may become more adept at using it in other contexts as well, such as informing those around them that a particular cuisine tradition is on the verge of extinction. It takes a lot of time to prepare traditional cuisine, while some of it requires a special cooking technique. Actually, if people consistently prepare a traditional food dish, they not only improve their culinary abilities but also pass along knowledge of traditional cuisine to the next generation. Knowledge is interpreted at many levels. Individual notions are decoded and arranged into a scheme with a more sophisticated meaning (Solomon et al., 2006). Knowledge may be acquired by education, experience, judgment, skill, and a combination of these (Bano et al., 2013; Rav-Marathe et al., 2016). According to Valente et al. (1998), the "learning" sequence, one of the various sequences in the triangle model, happens through information that accumulates to affect attitude, which in turn inspires perception/practice, and therefore has a K-A-P sequence (ab path).

### **ATTITUDE**

Different attribute aspects of attitude are psychological objects. Consumers' attitudes toward novel products can be described as either positive or negative, detrimental or useful, agreeable or unpleasant, liked or dislikeable (Ajzen, 2001). An individual's attitude is a learned mental and psychological level of readiness that determines or impacts how someone responds to all things and events that are pertinent to it (Allport, 1935). Opinions, emotional states, and beliefs about a thing or subject are all examples of attitudes. Customers come from a variety of cultures, demographic groups, and lifestyles. Another crucial factor is how one feels about behavior. The desire to eat ready meals as a culinary innovation seems to be influenced by



affective attitudes like satisfaction, enjoyment, and excitement. Being based on one's origin, one of the independent aspects is attitude, which is how one feels about traditional food innovation (Nie & Zepeda, 2011). Attitude may be defined in two ways: psychologically and socially. Although sociology is a verbal statement intended to act, psychology is a verbal expression connected to conduct (Chaiklin & Harris, 2011). For practical courses, it is essential to learn each student's unique attitudes since they must exhibit a certain personality type in order to put the course into practice. Attitudes are frequently learned and created via experience and/or interactions (Eagly & Chaiken, 2007), and while they are not always permanent, they tend to be constant (Lombard-Roberts & Parumasur, 2017). Existing attitudes are also frequently difficult to modify since attitudinal development occurs gradually and customers are typically reluctant to change (Price, 2019). As a result, marketers should consider tailoring their communications to meet current sentiments rather than attempting to alter them (Kotler & Keller, 2012). Consumer attitude may be characterized as behavior toward people, objects, subjects, or circumstances (Solomon et al., 2006). It is frequently defined as general and lasting since it pertains to more than one event and tends to last over time (Solomon et al., 2006). Attitudes are frequently learned and created via experience and/or interactions (Eagly & Chaiken, 2007), and while they are not always permanent, they tend to be constant (Lombard-Roberts & Parumasur, 2017).

## **PRACTICE**

The last component of the KAP model is practice. According to (Badran, 1995), Practice is characterized as a combination of knowledge and attitude. Practice is the act of demonstrating one's attitude and level of understanding with deeds (Kaliyaperuma, 2004). According to (Launiala, 2009), Practice is the use of standards and knowledge to obtain performance results. Being a good practitioner is an art form that is inherently conducted responsibly and is associated with the growth of knowledge and technology. Currently, the food industry's innovation procedures heavily rely on customer feedback, which is acknowledged as being essential to success. As a result, developing a successful new product requires tactics that combine an adequate sensory evaluation with a thorough grasp of the consumers' acceptance requirements. Besides that, practice describes a person's behavior. In research on nutrition and food, practice or behavior is translated as eating, cooking, feeding someone, or other activities involving the preparation and consumption of food. The diversity of a diet, the consumption of certain foods, the frequency of consumption of particular meals,

and particular dietary patterns can all be used to study food practices. One of the more important sectors in the current global economy is the food one. However, businesses involved in the manufacturing, processing, and provision of food still confront a number of difficulties, the most important of which is the prevalence of new goods that fail. The voice of the customer is given paramount importance in today's innovation practices in the food sector, which are understood to be necessary for success.

### **Research Hypothesis**

There were three hypotheses tested in this study to investigate the link between the independent variables (knowledge, attitude, and practice) and the dependent variable (consumer acceptance of innovation in traditional food among undergraduate students).

H1: There is a significant relationship between knowledge and consumer acceptance of innovation in traditional food among Undergraduate students

H2: There is a significant relationship between attitude and consumer acceptance of innovation in traditional food among Undergraduate students

H3: There is a significant relationship between practice and consumer acceptance of innovation in traditional food among Undergraduate students.

### **Research framework**

A study framework was developed to explore the relationship between consumer acceptability of traditional foods and knowledge, attitude, and practice among undergraduate students.

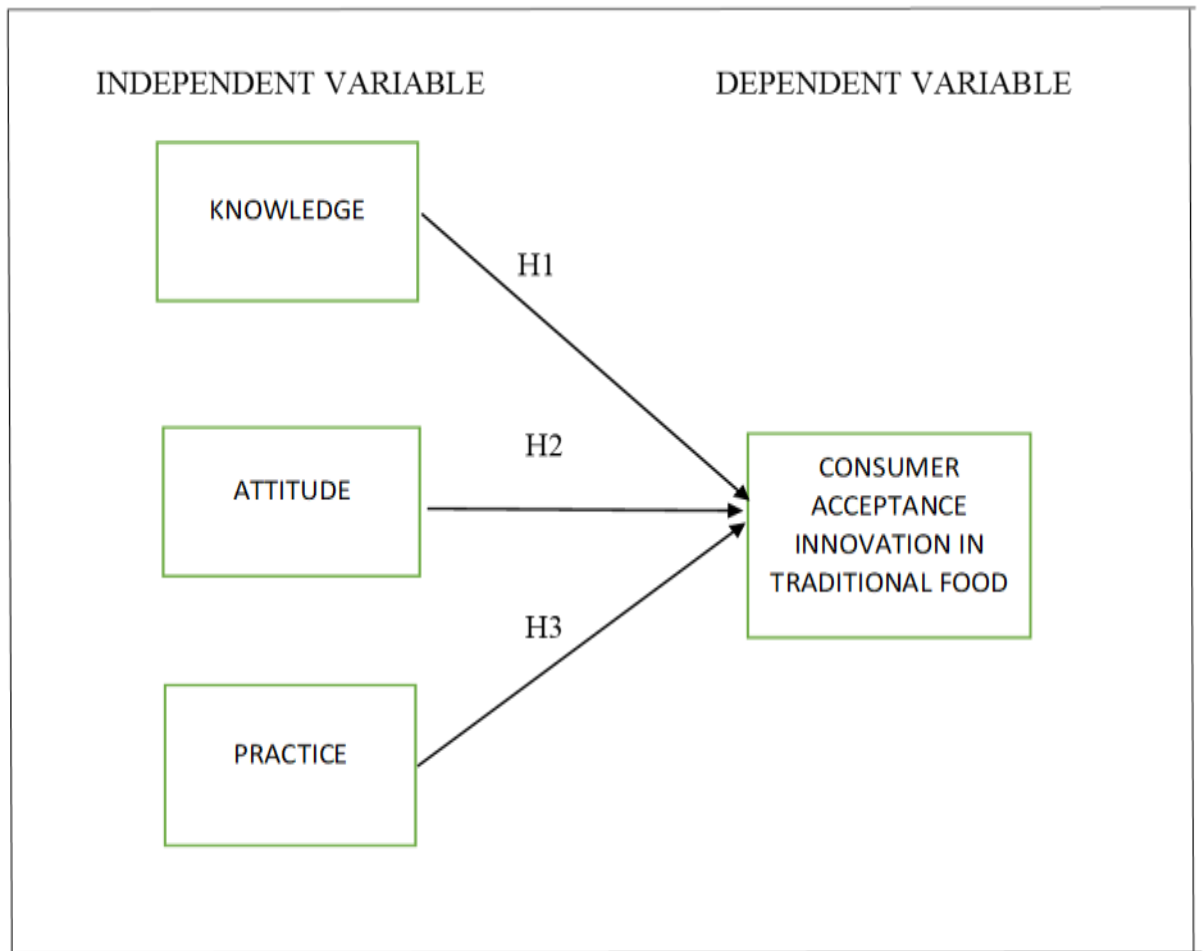

Figure 1: Conceptual Framework of consumer acceptance of Innovation in traditional food among undergraduate students.

## METHODOLOGY

### Research Design

This study was conducted utilizing quantitative methodologies using the researcher's own raw data. To solve the research issue, the researchers used an experimental or causal study technique (Shariff, 2016). This is due to researchers' desire to learn whether customers prefer conventional food advancements. Researchers that conduct causality studies investigate the relationship between independent factors that are assumed to have an influence on the dependent variable. The major purpose of this study's design is to obtain evidence of causality or test hypotheses. Researchers investigated the relationships between knowledge, attitude, and practice (independent factors) and customer acceptability of traditional food innovation (dependent variables) in this study.

## **Sampling**

To probability data for the study, the probability sampling approach is employed. The sampling approach is utilized in this study to determine how much and how frequently data collecting is required. This tool determines how many samples are needed to analyse a system, technique, problem, or issue. This sample has reached the end of its stages. In the first stage, the target demography must be properly specified. The following step is to select a sample frame. To correctly represent the population, researchers must select a sample frame. The sampling procedure is decided in the third phase of the sampling technique. There are two types of sample processes: probability sampling and non-probability sampling. The next step is to determine the sample size.

The selection of a population's subgroups is known as the sample size, which is used to draw inferences or judgments about the total population. A table previously made by Krejcie and Morgan (1970), which used the population's current approach, was used to determine the size of the study sample.

## **Data Analysis**

Three different types of data analysis were employed in this study: frequency analysis, descriptive analysis, and reliability analysis. The data were examined using the Statistical Package for the Social Sciences (SPSS).

## **FINDINGS**

Using variable data gathered from a particular subject group, descriptive analysis is a type of statistical analysis that aims to provide a description or image of the subject under investigation. In tables of frequency distribution, histograms, mean values, standard deviation values, and other formats, the descriptive analysis of the data may be displayed. The descriptive analysis had the benefit of providing a thorough picture of the data, whether it was presented verbally or quantitatively.

390 respondents made up the sample we used for the data analysis. Table 1 shows the data-collecting correlations, and Table 2 displays a summary of the hypothesis testing.

Table 1 shows the correlations of the data collection

correlations				
	Consumer Acceptance Innovation in traditional food	knowledge	Attitudes	Practice
Consumer Acceptance Innovation in traditional food	1	0.456**	0.765**	0.732**
Knowledge	0.456**	1	0.517**	0.421**
Attitudes	0.765**	0.517**	1	0.750**
Practice	0.732**	0.421**	0.750**	1

\*. Correlation is significant at the 0.05 level (2-tailed)

\*\*. Correlations are significant at the 0.01 level (2-tailed)

Table 2 shows the summary of the hypothesis testing

Summary for Hypothesis Testing		
Hypothesis	Pearson Correlation	Result
H1: There is a significant relationship between Knowledge and consumer acceptance of innovation in traditional foods among undergraduate students.	$r = 0.456, p < 0.01$	Supported
H2: There is a significant relationship between Attitude and consumer acceptance of innovation in traditional foods among undergraduate students.	$r = 0.765, p < 0.01$	Supported
H3: There is a significant relationship between Practice and consumer acceptance of innovation in traditional foods among undergraduate students.	$r = 0.732, p < 0.01$	Supported

**Research Objective 1: To investigate the relationship between knowledge and consumer acceptance of traditional food innovation.**

The first objective is to ascertain if knowledge will affect undergraduate students' awareness of practising innovation in traditional food. Also being discussed is the first of the following hypotheses:

H1: There is a significant relationship between Knowledge and consumer acceptance of innovation in traditional foods among undergraduate students.

Based on the findings and analysis of Chapter 4, the findings show that knowledge and consumer acceptability of innovation in traditional foods among undergraduate students have a substantial link. Undergraduate students had the lowest correlation coefficient (approximately 0.456) for knowledge and customer acceptability of innovation in traditional foods in this study goal. The knowledge p-value and

The standard deviation of acceptability among consumers is 0.000, which is below the extremely significant level of 0.01. Therefore, among undergraduate students, there is a substantial link between consumer approval of innovation in traditional food and knowledge.

The production of traditional foods has been practiced for many generations, hence traditional food knowledge is a blend of knowledge and practices (United Nations, 2007). Traditional food knowledge (TFK) is a food product that is adopted and passed down from generation to generation, (Kwik, 2008). In other words, it is a process of passing along knowledge, preparation, and cooking techniques that enable people to create meals that are wholesome, secure, and appropriate for their culture. The fact that the younger generation lacks knowledge and abilities in the preparation of traditional foods is due to a number of issues. Lack of knowledge, insufficient exposure to the cooking process, a lack of enthusiasm in trying because it takes time, and a lack of time to learn from specialists are the contributing factors, (Mohd Salehuddin bin Zahari, 2013).

**Research Objective 2: To investigate the relationship between attitude and consumer acceptance of traditional food innovation.**

The second objective is to ascertain if undergraduate students' attitudes would affect their knowledge of using innovation in traditional meals. The discussion also centres on the first premise listed below:



H2: There is a significant relationship between attitude and consumer acceptance of innovation in traditional foods among undergraduate students.

Based on the findings from Chapter 4's results and analysis, it can be concluded that undergraduate students' attitudes have a big impact on whether consumers embrace innovation in traditional food. The first highest correlation coefficient, or 0.765, in this study aim relates to undergraduate students' attitudes and consumer acceptance of innovation in traditional food. Consumer approval and attitude have a p-value of 0.000, which is below the highly significant level of 0.01. Consequently, there is a significant relationship between attitude and consumer acceptance of innovation in traditional foods among undergraduate students.

A person's attitude is their evaluation of anything or something in a situation. According to Nie and Zepeda (2011), they were distinctive and closely related to culture, demography, values, way of life, and habits. As attitudes affect both expectations and perception, they are essential in a consumer acceptance system. They could also be used to define consumer groups according to demographics and product acceptability.

**Research Objective 3: To investigate the relationship between practice and consumer acceptance of traditional food innovation.**

The third objective is proposed to determine whether the practice will influence awareness of practicing innovation in traditional food among undergraduate students. Discussion is also based on the first hypothesis below:

H3: There significant relationship between practice and consumer acceptance of traditional food among undergraduate students.

Based on the findings and analysis in Chapter 4, the findings show that practise and consumer acceptability of innovation in traditional cuisine among undergraduate students have a substantial link. The second-highest correlation coefficient in this study aim is related to undergraduate students' attitudes and consumer acceptance of innovation in traditional foods, which is around 0.732. Consumer approval and attitude have a p-value of 0.000, which is below the highly significant level of 0.01. Therefore, among undergraduate students, there is a considerable link between practise and consumer acceptability of innovation in traditional meals.

Practice is the use of norms and knowledge to produce performance outcomes, according to Launiala (2009). Being a good practitioner is an art form that is connected to the advancement of information and technology and is handled ethically by nature. Customer input is currently a major component of the innovation processes used in the food sector, which is recognized as being crucial to success. The mothers who were interviewed all concurred that the wave of modernization or development has a minor influence on the generational practices regarding the traditional diet of Malaysia, (Mohd Salehuddin bin Zahari,2013). This shows, the practice has a relationship among undergraduate students. having a practice from generation to generation can attract them to the acceptance of innovation in traditional food.

## **DISCUSSION AND RECOMMENDATION**

The future study should use a multilingual questionnaire to reduce language barriers and gather data more quickly and accurately. It is recommended to consider all available criteria to gain a better understanding of customer needs and preferences. Better data collection should be prioritized, with a longer window of time for respondents to provide more information on Malay traditional food innovation. A qualitative approach with open interviews can help researchers gain a deeper understanding of human interaction and provide more detailed responses. Additionally, researchers should include more information about traditional food innovations in their questionnaires to make it easier for respondents to respond and provide clear answers. Future researchers should be well-informed and well-equipped with relevant data to respond to questions and deepen their understanding of the subject.

## **CONCLUSION**

This study examines the relationship between consumer acceptance of innovation in traditional foods among undergraduate students (Knowledge, Attitude, and Practice). 390 questionnaires in total were gathered from the intended respondents, who were undergraduate students. All the 390 surveys that were gathered were valid and could be read. Therefore, this study shows a beneficial association between customer approval of conventional food innovation and undergraduate students. Additionally, this study discovered that among undergraduate students, the attitude had the greatest influence on whether consumers accepted innovations in traditional food, whereas knowledge had the least impact.

## REFERENCES

- Abdullah, K. M., & Azam, N. R. A. N. (2021). Innovated Malay Traditional Food Products: Do Consumers Accept the Authentic Quality? *Social Sciences*, 11(16), 199-208. <http://dx.doi.org/10.6007/IJARBSS/v11-i16/11228>
- Akter, M., Sadekin, M. N., & Patwary, A. K. (2020). An Empirical Study on Students' Satisfaction from Mawlana Bhashani Science & Technology University, Bangladesh. *Review of Economics and Development Studies*, 6(2), 363-379.
- Almli, V. L. (2012). *Consumer acceptance of innovations in traditional food. Attitudes, expectations and perception* (Doctoral dissertation, Norwegian University of Life Sciences). [https://www.researchgate.net/profile/Valerie-Almli-2/publication/234126651\\_Consumer\\_acceptance\\_of\\_innovations\\_in\\_traditional\\_food\\_Attitudes\\_expectations\\_and\\_perception/links/09e4150f67b2dbc60e000000/Consumer-acceptance-of-innovations-in-traditional-food-Attitudes-expectations-and-perception.pdf](https://www.researchgate.net/profile/Valerie-Almli-2/publication/234126651_Consumer_acceptance_of_innovations_in_traditional_food_Attitudes_expectations_and_perception/links/09e4150f67b2dbc60e000000/Consumer-acceptance-of-innovations-in-traditional-food-Attitudes-expectations-and-perception.pdf)
- Alom, S., Patwary, A. K., & Khan, M. M. H. (2019). Factors affecting the turnover intention of Bangladeshi migrants in the United Arab Emirates: An empirical study on the hotel industry. *International Journal of Innovation, Creativity and Change*, 8(3), 344-360.
- Bhuwandeep, P. P. D. (2021). Study on Knowledge, Attitude, and Practice (KAP) of sustainable consumption behaviour among college students. *Journal of Asia Entrepreneurship and Sustainability*, 17(4), 125-141. [https://www.researchgate.net/publication/349585932\\_Study\\_on\\_Knowledge\\_Attitude\\_and\\_Practice\\_KAP\\_of\\_sustainable\\_consumption\\_behavior\\_among\\_college\\_Students](https://www.researchgate.net/publication/349585932_Study_on_Knowledge_Attitude_and_Practice_KAP_of_sustainable_consumption_behavior_among_college_Students)
- Ellet, P. (2019, october 21). *What is undergraduate education?* Retrieved from hotcourseabroad: <https://www.hotcoursesabroad.com/study-abroad-info/applying-to-university/what-is-undergraduate-education/>
- Etwaroo, D. H., Goburdhun, D., & Ruggoo, A. (2022). Knowledge, Attitude and Practices regarding Food Additives of Food SMEs in Mauritius. *Scientific African*, e01534. <https://www.sciencedirect.com/science/article/pii/S2468227622004380>
- Fengmin, Z., Baijun, W., Jiangtao, B., Li, L., & Patwary, A. K. (2022). Investigating revisit intention of medical tourists in China through nutritional knowledge, perceived medical quality, and trust in the physiologist: A recommendation on health tourism policy measures. *Frontiers in Public Health*, 10, 893497.
- Guerrero, L., Guàrdia, M. D., Xicola, J., Verbeke, W., Vanhonacker, F., Zakowska-Biemans, S., & Hersleth, M. (2009). Consumer-driven definition of traditional food products and innovation in traditional foods. A qualitative cross-cultural study. *Appetite*, 52(2), 345-354. <https://www.sciencedirect.com/science/article/pii/S0195666308006065>
- Guiné, R. P., Florença, S. G., Barroca, M. J., & Anjos, O. (2020). The link between the consumer and the innovations in food product development. *Foods*, 9(9), 1317. [https://www.academia.edu/76791729/The\\_Link\\_between\\_the\\_Consumer\\_and\\_the\\_Innovations\\_in\\_Food\\_Product\\_Development](https://www.academia.edu/76791729/The_Link_between_the_Consumer_and_the_Innovations_in_Food_Product_Development)
- Hazbar, A. M. H., Alem Mohammed, A., & Karim, A. K. A. (2019). An Empirical Study of Factors Influencing hotel customers' online booking Intention. *مجلة العلوم التربوية و الدراسات الإنسانية*, (5), 1-17.
- Kuhnlein, H. V., & Receveur, O. (1996). Dietary change and traditional food systems of indigenous peoples. *Annual review of nutrition*, 16(1), 417-442. [https://www.researchgate.net/profile/Harriet-Kuhnlein/publication/14365338\\_Dietary\\_Change\\_and\\_Traditional\\_Food\\_Systems](https://www.researchgate.net/profile/Harriet-Kuhnlein/publication/14365338_Dietary_Change_and_Traditional_Food_Systems)

[of Indigenous Peoples/links/00b7d528bf7db1393d000000/Dietary-Change-and-Traditional-Food-Systems-of-Indigenous-Peoples.pdf](#)

- Lambden, J., Receveur, O., & Kuhnlein, H. V. (2007). Traditional food attributes must be included in studies of food security in the Canadian Arctic. *International Journal of Circumpolar Health*, 66(4), 308–319. <https://doi.org/10.3402/ijch.v66i4.18272>
- Li, L., Ragavan, N. A., Patwary, A. K., & Bajun, W. (2022). Measuring patients' satisfaction toward health tourism in Malaysia through hospital environment, nutritional advice, and perceived value: A study on Chinese exchange students. *Frontiers in public health*, 10, 893439.
- Li, L., Wu, B., & Patwary, A. K. (2022). How marine tourism promote financial development in sustainable economy: new evidences from South Asia and implications to future tourism students. *Environmental Science and Pollution Research*, 29, 1155-1172.
- Li, L., Wu, B., & Patwary, A. K. (2022). The psychosocial factors affecting chinese Outbound Exchange and mobility students' academic performance during COVID-19. *Frontiers in psychology*, 13, 872516.
- Patwary, A. K., Roy, B., Hoque, R., & Khandakar, M. S. A. (2019). Process of developing a community based tourism and identifying its economic and social impacts: An Empirical study on Cox's Bazar, Bangladesh. *Pakistan Journal of Humanities and Social Sciences*, 7(1), 1-13.
- Renner, A. (2011). Definition of terms. In *Does carbon-conscious behavior drive firm performance?* (pp. 54-63). Gabler. [https://link.springer.com/chapter/10.1007/978-3-8349-6224-9\\_3](https://link.springer.com/chapter/10.1007/978-3-8349-6224-9_3)
- Sadat, S. H., & Nasrat, S. (2020). The practice of open innovation by SMEs in the food industry. *Journal of Innovation Management*, 8(2), 26-46. [https://journalengineering.fe.up.pt/index.php/jim/article/view/2183-0606\\_008.002\\_0004](https://journalengineering.fe.up.pt/index.php/jim/article/view/2183-0606_008.002_0004)
- Schober, P., Boer, C., & Schwarte, L. A. (2018). Correlation coefficients: appropriate use and interpretation. *Anesthesia & Analgesia*, 126(5), 1763-1768. <https://www.ingentaconnect.com/content/wk/ane/2018/00000126/00000005/art00051>
- SPSS Inc. (2009). About SPSS Inc. Retrieved from <http://www.spss.com.hk/corpinfo/history.htm>
- Sumethokula, P., Patwary, A. K., Srinuanpanc, B., Srinuanpand, C., Suwandee, P., Thammathikul, A., & Phanong, W. (2020). The potential of new tour repackaging for creative tourism among entrepreneurs in Nakhon Si Thammarat. *International Journal of Innovation, Creativity and Change*, 13(10), 1752-1771.
- Wasil, A. H., Shah, J. A., & Haris, N. B. M. (2022). The Relationship between Knowledge, Attitude, and Practice toward Organic Fertilizer Adoption among Almond Smallholder Farmers in Uruzgan, Afghanistan. *International Journal of Academic Research in Business and Social Sciences*, 12(10), 2895 – 2914.: <http://dx.doi.org/10.6007/IJARBS/v12-i10/15108>
- Wu, B., Liu, S., Wang, J., Tahir, S., & Patwary, A. K. (2021). Assessing the mechanism of energy efficiency and energy poverty alleviation based on environmental regulation policy measures. *Environmental Science and Pollution Research*, 28, 40858-40870.
- Wu, B., Zhai, B., Mu, H., Peng, X., Wang, C., & Patwary, A. K. (2021). Evaluating an economic application of renewable generated hydrogen: A way forward for green economic performance and policy measures. *Environmental Science and Pollution Research*, 1-15.

# THE STUDY ON VISITOR'S ACCEPTANCE OF TRADITIONAL MALAY FOOD IN MALAYSIA

Anggun, Anis Farhani, Anis Nadhirah, Aqilatul Husna & \*Derweanna Bah Simpong

Faculty of Hospitality, Tourism and Wellness, University Malaysia Kelantan.

---

## ABSTRACT

The cuisine of the Southeast Asian ethnic Malays who reside in Malaysia is known as traditional Malay cuisine. It stands out for using a lot of spices. Nowadays, visitors to Malaysia tend to prefer 'modern snacks' or quick food over traditional dinners. The gastronomic preferences of today's guests have influenced their decisions. This is a result of the high demand for fast food and other modern food items, which suit customers' busy lifestyles. As an outcome of this, the purpose of the study was to investigate how food knowledge, attitude, and image affect the way in which visitors accept traditional Malay food. There were 400 participants in this survey-based study. Visitors between the ages of 18 and 30 are the subject of this study. Using a quantitative research design, this study was conducted. The Pearson correlation coefficient was used in the study to look at the connection and influence between independent factors and dependent variables. The results of this study indicate that each of these factors plays a part in how well-liked traditional Malay food is among visitors. This is supported by the researchers' findings on the Pearson correlation coefficients for each variable. The extremely positive and substantial correlation between gained food knowledge and the P value was 0.680. Second, with a P value of 0.678, associations for food attitudes were shown to be favorable and significant. Finally, the P value for the strong positive and significant relationship between the food image and the P value was 0.785. This study demonstrated how visitor food knowledge, attitude, and image affect their acceptance of traditional Malay food.

**Keywords:** Malay Traditional Food, Visitor, Food Knowledge, Food Attitude, Food Image

## INTRODUCTION

The term "hospitality" refers to an industry that encompasses a wide range of service-related professions and industries, such as the hotel industry, the food and beverage service industry, event organising, theme parks, travel and tourism, and more. As a result, lodging facilities, tour operators, eateries, and bars are all involved. 2007 (Andrew). The definition of hospitality in the Merriam-Webster Dictionary is "the generous and amiable reception of visitors and guests or the practice of hospitality." It also denotes the area of the economy where hotels, caterers, and event planners are most frequently employed.

According to Weichselbaum et al. (2009) and Almlı (2012), traditional meals have frequently played an important role in the customs of many cultures and regions, helping to build their sense of who they are and their sense of satisfaction. These are traditional dinners that have long been loved in the local and regional communities. (Almlı, 2012; Weichselbaum and others, 2009. Even while most people can recall at least one regional traditional dish (Weichselbaum et al., 2009), describing regional traditional dishes might be challenging since regional traditional food can signify a million different things to a million different people. European Commission, 2007. It is important to define "traditional" in order to assess the viability of alternative production systems for traditional foods (Guerrero et al., 2010).

The Malay people of Malaysia owe a debt to their Malay ancestors for introducing them to a wide variety of traditional cuisines, like Ketupat Palas, Lemang, Nasi Lemak, and others. Department of National Heritage Malaysia (2019) formally acknowledged these foods as representative of traditional Malay food. During this time, visitors who traveled throughout Southeast Asia on business created and disseminated Malay customs, including traditional food and language. As a result, this was a growth moment for traditional Malay food. The introduction of Islam in Malay communities in the 12th century also contributed to the development of a unique Malay culture. At that time, Islamic teachings and life philosophies were closely related to traditional Malay cuisine.

The dictionary defines a tour as "a journey from place to place [that consists of] visits to several places along a route through an area." Making a tour, also known as "circuitous travel, in any direction," is what the transitive definition of the verb tour refers to. A tour is a lengthy excursion that can be taken for either pleasure or business; the act of taking a tour is referred to as "arranging" for a "series of visits." In seventeenth-century London, the term "take a turn" was used to describe a "tour" that involved going about a place, frequently in a coach, such as a park.



## **RESEARCH OBJECTIVES**

1. To examine the effects of food knowledge on the acceptance of visitors on Malays traditional food in Malaysia.
2. To examine the effects of food attitudes towards the acceptance of visitors on Malays traditional food in Malaysia.
3. To examine the effects of food image towards the acceptance of visitors on Malays traditional food in Malaysia.

## **SIGNIFICANCE OF THE STUDY**

Many academic fields, including human ecology, agriculture, health promotion, parenting styles, community involvement, and sociological, sociocultural, and nutritional studies, to name a few, use traditional food knowledge (Warren, 2002). Traditional food practices are those that are thought to help preserve the integrity of natural resources when it comes to supplying food for humans. In this context, "traditional cuisine" refers to culinary techniques that have been developed over many generations and places. Traditional ecological food knowledge has been employed in Western communication since the late 1970s and early 1980s (Kuhnlein V. et al, 2009).

Communities are particularly concerned about the loss of traditional foods and cooking techniques, particularly among visitors. (2011) (Almli et al.), According to many experts, countries risk losing part of their traditional cuisines if traditional food preparation methods are not passed down to the next generation (Albayrak & Gunes, 2010; Bowen & Devine, 2011). There is a steadily declining quality of the culinary cultural inheritance since there aren't enough skilled traditional cuisine cooks, especially among the older generations, to pass on knowledge and abilities to the following generation. Due to a lack of competent cooks who can teach the next generation skills and knowledge about traditional foods, the culinary cultural heritage is deteriorating at an increasing rate. The government can set up processes to support further research and development in traditional foods through a Centre or Institute within the Ministry of Tourism Malaysia. This would allow for the improvement of traditional food preservation, as well as the transmission of traditional culinary expertise to visitors.

## LITERATURE REVIEW

### Visitor's acceptance of Traditional Malay Food in Malaysia

Traditional diets have been followed by many generations or passed down from one era to the next. Meals and dishes that are considered traditional have their roots in a particular culture's cuisine, whether that's a national dish, regional cuisine, or a local speciality. Major food processing industries, smaller manufacturing facilities, and individual homes can all contribute to the production of staple foods and drinks. (2016) Oliveira and Kristbersson. Several variables have altered traditionally prepared meals. One of these factors is the accessibility of necessary raw materials. This means that farming methods and geographical location play a role in shaping regional cuisine. Vegetation, for instance, varies greatly in regions of varying altitudes. Countries that lack a substantial coastline typically have a smaller supply of fish and seafood than those that have. While many traditional foods continue to play an important part in a healthy diet today, others may not meet the nutritional needs of modern populations due to their high energy or fat content. So, it makes sense to update the nutritional profile of some classic dishes so that they better suit the needs of the 21st century. The healthful Mediterranean diet may have inspired a shift away from less-than-ideal traditional food compositions and towards using more readily available local ingredients in the past.

Faiz et al.(2017) argue that Malaysia holds the title of “Rice Bowl of Malaysia” because the food will not be complete if it is not served with rice. Food traditional can be classified by state in Malaysia. Athirah (2013) stated that the traditional type of food in the state of Kelantan is Nasi Kerabu, while Faizal et al. (2015) said that the type of traditional food is according to festivals and food symbolic to a state. Traditional confectionery is a food that unites the Malaysia community. Traditional kuih are a factor of cultural diversity and there are variations of kuih which are available now (Mudiana, 2020). As an example of a traditional kuih that is mentioned is *kuih seri muka*, *lepat pisang*, *kuih koci*, *karipap*, and so on. Hairis (2009) states that most tourists from other countries give a positive response to the Malaysian traditional food and traditional kuih has the potential to become a visitor food product attraction. Traditional Malay food is the food of the Malays, an ethnic group native to Southeast Asia. Spices have a significant role in traditional Malay cuisine. Coconut milk adds to the already luxurious texture

and flavour of Malay cooking. The other ingredient is belacan, which is a "prawn paste" used to make sambal, a spicy sauce made from belacan, chilli peppers, onions, and garlic. Both lemongrass and galangal are staples in Malay cuisine (James, 2006). The several courses of a Malay lunch are presented simultaneously rather than in stages. Malay culture emphasises using only the right hand for eating, as the left is allocated for cleanliness and hygiene.

### **Food Knowledge**

The term "traditional food knowledge" refers to the cultural practises that have been passed down from one generation to the next in order to share information, skills, and ideas on food. In particular for marginalised communities, familiarity with traditional foods can help members feel more connected to their heritage and strengthen bonds among family and friends. In addition to connecting cultural diasporas, such data could be utilised to fortify the cultural identities of generations raised in the wake of migration. As an intergenerational practice, traditional food knowledge transfer also helps to socialize. When local food systems and cultures undergo change as a result of global industrialization, urbanisation, and cultural homogenization, traditional food knowledge may be lost within homes and communities. Traditional culinary knowledge is lost when it is recast as an area of industrial production, which can have negative effects on regional cuisine and its unique flavour profiles (Kwik, 2008).

H1: There is a relationship between food knowledge and visitor's acceptance of traditional Malay food in Malaysia.

### **Food Attitude**

Many people engaged in the food industry have reported difficulties with customer attitudes. It also describes the ways in which people make decisions about what to eat based on biological or economic considerations, such as preference, cost, purity, ease of preparation, difficulty of preparation, and access to fuel and other necessary equipment. Accessibility, familiarity, previous experience, and availability are some of the elements that contribute to the formation of opinions held by visitors regarding the food that they consume while on vacation. A person's nutrition can be influenced by a variety of factors, including those cultural, familial, social, and interpersonal. Emotion, tension, and guilt are all examples of elements that fall under the psychological category. views, ideas, and comprehensions pertaining to the topic of food.

Food attitudes are influenced by a multitude of factors, including a person's personal taste, the sensory quality of the food, the cost of the food, its accessibility, its convenience, cognitive limits, and cultural familiarity. In addition, social cues and larger serving sizes affect people's dietary habits (Wansink and Brian, 2004).

Everyone has various eating habits and tastes. These preferences can be shaped over time by a variety of factors, including personal experiences such as being encouraged to eat, being exposed to a meal, the customs and rituals of the family, the effect of advertising, and personal views. For instance, one person may dislike fries despite the fact that they are a popular delicacy among visitors. A cultural group defines proper meals, dietary pairings, eating habits, and eating behaviors. Individuals who adhere to these norms have a sense of belonging and identification. Subgroups within large cultural groups may practice modifications of the group's eating habits, but they are still considered a part of the larger group. A cheeseburger, French fries, and a Coke are typical western meals.

H2: There is a relationship between food attitude and visitor's acceptance of traditional Malay food in Malaysia.

### **Food Image**

Due to the current trend of "camera eat first," it will assist to draw customers when the meal presentation and image are good. People are taking pictures of their meals before they eat it and uploading them to social media in a trend known as "camera eats first.". According to (Julia, 2017), the picture platform "flickr" has seen a growth of more than 6,000,000 "food" images in the previous two years. In February of 2017, there were 168,375,343 posts on Instagram related to food, proving that 90 images are published and hash-tagged every 60 seconds. Thus, how cuisine is presented has a significant influence on how interested tourists are in visiting Malaysia.

H3: There is a relationship between food image and visitor's acceptance of traditional Malay food in Malaysia

## Acceptance

There are a variety of reasons why someone could like or dislike a certain meal. It is challenging to make connections between a person's physiological experience and behaviour when complex food matrices are considered. In addition to the food's physiological and aesthetic properties, factors such as marketing, availability, prior experience, attitudes, and beliefs shape how people respond to it. Methods other than surveys were investigated in this study to learn more about consumers' opinions, routines, and future plans. The acceptance of a meal depends on the connection between the diner and the dish. Consumers' acceptance of a product can be affected by a wide range of demographic parameters, including age, gender, physiological and psychological features, and contextual factors such as family and cultural norms, religion, education, fashion, price, and convenience. A person's level of appreciation for a given dish should have a significant impact on his or her consumption patterns. This is a reasonable assumption, and few would disagree with it (Meiselman & Bell, 2003).

## Research Framework

The relationship between visitor acceptance of traditional Malay cuisine in Malaysia and food knowledge, food attitude, and food image has been investigated using a conceptual framework.

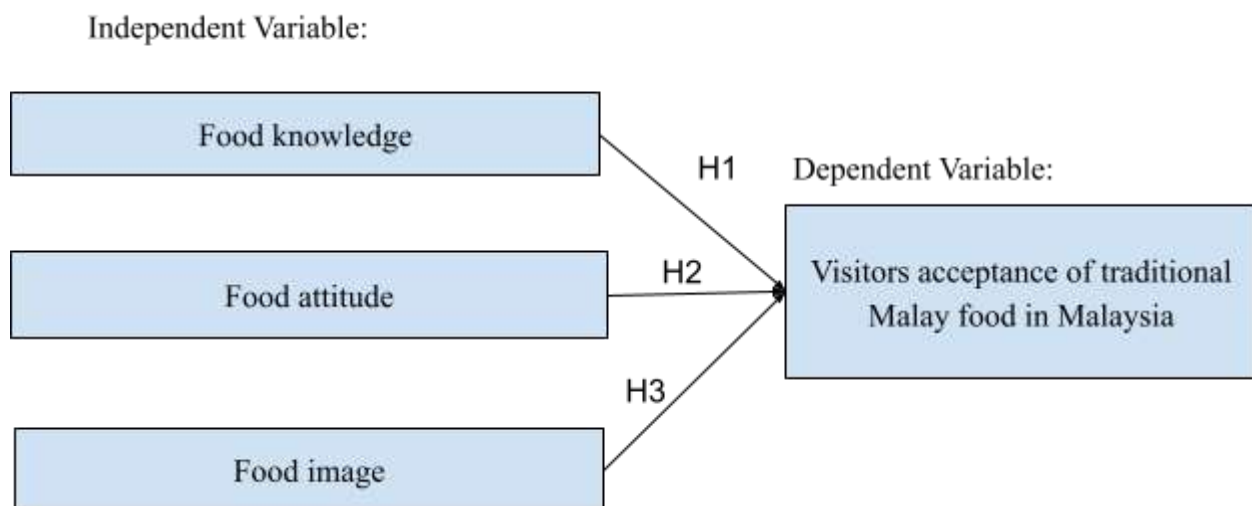

Figure 1: A conceptual framework to examine visitors' acceptance of traditional Malay food.

Source: Developed of the study

## **METHODOLOGY**

### **Research Design**

According to Shuttleworth (2008), this study used the quantitative method, which focuses on proving or disproving hypotheses in a way that is important by looking at variables that have been clearly defined. Quantitative data consists of numerical information that has been compiled through dependable and standardised means of data collection, then analysed statistically. This finding ought to be generalizable, and as a result, it is capable of being utilised with other populations, allowing for an examination of cause and effect as well as the formulation of hypotheses. Leung (2015). According to Kelley et al. (2003), surveys, interviews with closed questions, and controlled experiments are common ways to generate data.

### **Sampling**

A random sample method is used to collect data for the investigation. The method of simple random sampling will be used in this research questionnaire. "Simple random sampling" describes a specific sort of random sampling in which every member of the population has the same, predetermined chance of being selected as part of the sample. Researchers will randomly assign attendees to different groups in order to collect the necessary information. Researchers will employ quantitative methods to examine and analyse the data they get from these participants. All data collected will be treated as confidential and utilised exclusively for this study. Then, we'll utilise these numbers to look for patterns in the variables and determine their averages, standard deviations, and correlations with one another.

The sample size represents a subset of the entire population. The researcher needs to be able to extrapolate from the instances to the overall number of people of interest. There is insufficient data to calculate the precise number of constituents that make up the population's profile. Consequently, it is impossible to estimate a sample size that is statistically significant for the whole population. Therefore, the researcher opted to employ a sample size of 400 respondents based on the guidelines provided by (Krejcie & Morgan, 1970).

## Data Analysis

This research used frequency analysis, descriptive analysis, reliability analysis, and the Pearson correlation coefficient. SPSS (Statistical Package for the Social Sciences) was used for the data analysis.

## FINDINGS

### Result of Pearson Correlation Analysis

Table 4 below shows the Pearson Correlation Analysis

Table 4.14 Pearson Correlation Analysis

Hypothesis	P. Value	Result (Support / Not Support)
H1: Food knowledge positively influences the acceptance of visitor	0.680	H1 is support
H2: Food attitude positively influences the acceptance of visitor	0.678	H2 is support
H3: Food image positively influences the acceptance of visitor	0.785	H3 is support

Table 4 shows that familiarity with food is significantly correlated with host friendliness ( $r = 0.680$ ,  $p > 0.01$ ). Similarly, a favourable outlook on food is significantly associated with a pleasant reception of visitors ( $r = 0.678$ ,  $p > 0.01$ ). The third correlated variable is confidence in



one's ability to choose a good restaurant. With  $r = 0.785$ ,  $p > 0.01$ , the association between food image and visitor acceptability is likewise statistically significant. All hypotheses were confirmed at the 0.05 level of significance.

**Research Objective 1:** To determine the effects of food knowledge towards the acceptance of visitors on Malays traditional food in Malaysia.

The data from KEKKWA (2008) backs up these conclusions. According to the results, visitors' openness to traditional Malay fare is strongly correlated with their level of food knowledge. Because of the importance of food in maintaining spiritual and ethnic identities, all visitors to Malaysia should be made aware of the importance of preserving food-related information for future generations. The efforts of the Malaysian Cultural Association, the Ministry of Information, Communication, and Culture, and other government organisations have contributed to the preservation of the traditional cooking practises of the Malay people. This was made abundantly evident when the former minister of culture, arts, and legacy urged Malaysians to teach visitors their culinary techniques in order to protect the country's culinary treasures (KEKKWA, 2008).

As a consequence of this, surveys on food have indicated that the presentation of traditional food from Malaysia has an effect on how it is received in other nations as well. Researchers were able to draw conclusions on the impact of participants' prior food expertise on their impressions of traditional Malaysian fare. This study lends credence to the first research question, which asked, "How does familiarity with regional cuisine influence the willingness of visitors to try dishes from Malaysia's cultural heritage?"

**Research Objective 2:** To determine the effects of food attitude towards the acceptance of Visitors on Malays traditional food.

According to the outcomes of Wansik and Bryan's (2004) study, an individual's level of acceptance of traditional Malaysian food is substantially connected with other people's perceptions of the food's acceptability. The visitor mentality, which is in turn influenced by their religious convictions, is the single most important factor in determining whether or not they will taste traditional Malay dishes. Whether or not one has a favourable impression of traditional Malay food depends on their level of familiarity with the cuisine and their eating habits. As

defined by Ajzen (1991b) and Pudun, Nor, and Chung (2016), subjective norms are the collective beliefs and expectations of a society as a whole. It's possible that the dish was only eaten in accordance with cultural norms and that no one actually ate it. It's the result of people having a generally pessimistic outlook on life.

There is evidence from studies on culinary attitudes, however, that these biases do affect how visitors perceive classic Malaysian food. The purpose of this research is to quantify how many visitors' enthusiasm for traditional Malaysian food actually helps spread cultural understanding of cuisine. This study also lends credence to the investigation of the aforementioned research topic, "What is the effects of food attitude towards the acceptance of Visitors on Malays traditional food?"

**Research Objective 3:** To determine the effects of food image towards the acceptance of Visitors on Malays traditional food.

It is possible to anticipate a person's feelings based on how they interpret a picture or visualisation. Many research in psychology have used this visual method to explain perception (e.g., Peterson & Kimchi, 2013; Wagemans et al., 2012), and it is true that one's vision is influenced by their goals and attention (e.g., Vecera et al., 2004; Desimone & Duncan, 1995). For many years, the Gestalt concept of images has also aided numerous academics in understanding perception (Koffka, 1935; Kohler, 1938). Many problems in the disciplines of visual research and emotion research have found resolution as a result of this concept. Emotion researchers use a 'pleasure-displeasure' scale to classify an individual's internal reactions to situations (Russell 1991).

As a result, the study's findings (Barrett, 2006 a, b) support the existence of an important connection involving the influence of food image and the acceptance of Malay traditional food among visitors. An individual's sense of valence provides a response to the good and negative stimuli elicited by a wide range of material and immaterial factors. Many theories in psychology (Rolls, 1999; Russell, 2003; Smith & Ellsworth, 1985; Scherer, 1984) set up a significant amount of stress on valence as a fundamental and important component of an individual's emotional life.

It's clear that the presentation of food influences how well visitors like traditional Malay food. The purpose of the study, which was to identify the impact of food appearance on visitors'

responses to traditional Malay costs, was successfully accomplished. The findings of this study also provided support for the question, "What is the effect of food image on visitor acceptance of Malays traditional food?"

## **DISCUSSION, LIMITATION AND RECOMMENDATION**

In general, this study has conducted significant research on the acceptance of traditional Malay food of visitors. The study investigated the association between three variables with traditional Malay food which are food knowledge, food attitude, and food image.

Due to the fact that respondents were not tested beforehand, the researcher discovered that the completion of the questionnaire took respondents an excessive amount of time. In spite of this, the researchers concluded that the findings of the investigation were sufficient. This is because the vast majority of people who participate in polls using Google Form questionnaires reside in distant or secluded areas. Because of this, completing the Google Form was challenging for the respondents, which was made much more difficult by the fact that their internet connection was poor.

For the purpose of future study, the results are also important. As a result, it is suggested that future scholars can locate more skilled providers of traditional food to preserve the culinary cultural history that is being lost with each passing generation. The study's author thinks that quantitative methods will remain the standard of excellence for future investigations in this area. Since quantitative analysis may be completed considerably more quickly than qualitative analysis and with far less effort.

## **CONCLUSION**

The main objective of this study is to analyse how familiarity with, and perceptions of, traditional Malay food are influenced by factors such as food knowledge, food attitude, and food image. Visitors were chosen at random to participate in this survey. Frequency analysis, descriptive analysis, reliability analysis, and Pearson Correlation analysis were used in SPSS to examine the survey data. There was a positive and important relationship between the acceptance of traditional Malay food and the three independent variables tested which are food knowledge, food attitude, and food image. This means that every hypothesis put forward, including H1, H2, and H3, is correct.

## REFERENCES

- Akter, M., Sadekin, M. N., & Patwary, A. K. (2020). An Empirical Study on Students' Satisfaction from Mawlana Bhashani Science & Technology University, Bangladesh. *Review of Economics and Development Studies*, 6(2), 363-379.
- Alom, S., Patwary, A. K., & Khan, M. M. H. (2019). Factors affecting the turnover intention of Bangladeshi migrants in the United Arab Emirates: An empirical study on the hotel industry. *International Journal of Innovation, Creativity and Change*, 8(3), 344-360.
- Fengmin, Z., Baijun, W., Jiangtao, B., Li, L., & Patwary, A. K. (2022). Investigating revisit intention of medical tourists in China through nutritional knowledge, perceived medical quality, and trust in the physiologist: A recommendation on health tourism policy measures. *Frontiers in Public Health*, 10, 893497.
- Hazbar, A. M. H., Alem Mohammed, A., & Karim, A. K. A. (2019). An Empirical Study of Factors Influencing hotel customers' online booking Intention. *مجلة العلوم التربوية و الدراسات الإنسانية*, 5(5), 1-17.
- J.Kwik. (2008). Traditional Food Knowledge; A Case Study of an Immigrant Canadian "foodscape". *Traditional food knowledge*.
- Kristbergson. (2016). Traditional Foods: General and consumer Aspects. *Intergrating Food Science and Engineering Knowledge Into the Food Chain*, 85- 86.
- Li, L., Ragavan, N. A., Patwary, A. K., & Baijun, W. (2022). Measuring patients' satisfaction toward health tourism in Malaysia through hospital environment, nutritional advice, and perceived value: A study on Chinese exchange students. *Frontiers in public health*, 10, 893439.
- Li, L., Wu, B., & Patwary, A. K. (2022). How marine tourism promote financial development in sustainable economy: new evidences from South Asia and implications to future tourism students. *Environmental Science and Pollution Research*, 29, 1155-1172.
- Li, L., Wu, B., & Patwary, A. K. (2022). The psychosocial factors affecting chinese Outbound Exchange and mobility students' academic performance during COVID-19. *Frontiers in psychology*, 13, 872516.
- Meiselman, B. (2003). *Encyclopedia of Food Sciences and Nutrition*(Second Edition).. John. (2007). The importance of the visual appearance of food processor and consumer. *Journal of Food Quality*, 267-278. Kristbergson. (2016). Traditional Foods: General and consumer Aspects. *Intergrating Food Science and Engineering Knowledge Into the Food Chain*, 85- 86.
- Patwary, A. K., Roy, B., Hoque, R., & Khandakar, M. S. A. (2019). Process of developing a community based tourism and identifying its economic and social impacts: An Empirical study on Cox's Bazar, Bangladesh. *Pakistan Journal of Humanities and Social Sciences*, 7(1), 1-13.
- Sumethokula, P., Patwary, A. K., Srinuanpanc, B., Srinuanpand, C., Suwandee, P., Thammathikul, A., & Phanong, W. (2020). The potential of new tour repackaging for creative tourism among entrepreneurs in Nakhon Si Thammarat. *International Journal of Innovation, Creativity and Change*, 13(10), 1752-1771.
- Warren, M. (2001). The role of the global network of indigenous knowledge resource centers in the conservation of cultural and biological diversity. In L. Maffi. (Ed.), *On biocultural diversity* (pp. 446- 461). Washington: Smithsonian Institute Press.

- Wu, B., Liu, S., Wang, J., Tahir, S., & Patwary, A. K. (2021). Assessing the mechanism of energy efficiency and energy poverty alleviation based on environmental regulation policy measures. *Environmental Science and Pollution Research*, 28, 40858-40870.
- Wu, B., Zhai, B., Mu, H., Peng, X., Wang, C., & Patwary, A. K. (2021). Evaluating an economic application of renewable generated hydrogen: A way forward for green economic performance and policy measures. *Environmental Science and Pollution Research*, 1-15.

# **The Study on Tourist Visit Intention Theme Park in Malaysia**

**Jennifer Jawat Nyambong, Asma'Ul Husna, Izzah Faizyah, Izzul Ikhwan & \*Nur Hafizah**

*Faculty of Hospitality, Tourism and Wellness, Universiti Malaysia Kelantan*

*Corresponding email: hafizahm@umk.edu.my*

---

## **ABSTRACT**

There are several famous theme parks in Malaysia that attract tourists from home and abroad and become one of the attractions that trigger a person's intention to visit and travel. The purpose of this study is to identify the factors that affect the intention of tourists to visit a theme park. The respondents of this study will be obtained from tourists in Malaysia and examine how individual profiles, preferences, motivations, and attitudes affect the intention to visit a theme park in Malaysia. A simple sampling method was used to obtain data with 384 valid goggle form responses. The questionnaire was distributed in an interval scale. Cronbach's Alpha was used to obtain trust results in the hope that this study can contribute to future researchers and marketers to understand more about tourists' visiting intentions towards theme parks.

**Keywords: Visit intention, Motivation, Attitude, Preference**

---

## INTRODUCTION

The largest and fastest expanding industries are in the hospitality and tourist sectors (Walker, 2013). Both industries are related to one another and fall under the same general heading. Walker (2013) argued that the five components of travel, hotel construction and event management, restaurants and managed services, and recreation make up both hospitality and tourist offerings. The research in this study will concentrate solely on the recreation component theme park, a product of the hospitality and tourism industry.

A theme park is a location that combines various types of entertainment, such as roller coasters and water rides, with retail stores, dining establishments, lodging, transportation services, and other entertainment facilities to provide fun and memorable experiences for people of all ages (Thomas, 2022). Theme parks are listed by the United Nations World Tourism Organization as one of the main attractions of a city.

Theme parks are one of the tourism goods in Malaysia that create income and have an impact on economic growth, having grown from a modest to one of the largest tourism sectors in the world (Hogan, 2015). According to Bernama (2012), the World Tourism Organization now lists Malaysia as the ninth most visited country in the world. The majority of visitors and locals are eager to attend theme parks to take advantage of the entertainment options, leisure settings, and recreational facilities.

With its 16 internationally renowned theme parks, including Legoland and Sunway Lagoon, Malaysia is a vacation destination that is rapidly expanding and gaining popularity. In addition, at least 10 theme parks are anticipated to open in the upcoming years. For instance, the Resorts World Genting will open the first 20th Century Fox World theme park on the planet later in 2019. On the other hand, the industry leader in video games, Ubisoft, intends to construct a theme park in Kuala Lumpur by the year 2020.

The theme park's presence would benefit the local community and the entire nation greatly. Theme parks have the ability to encourage tourism, which enhances the reputation of the place and boosts economic growth where they provide opportunities for people to engage in education, recreation, and enjoyment. Additionally, a theme park will boost local residents' employment rates.

Theme parks are crucial for both tourism and the overall economy of the nation. To understand and meet visitor demand, it is crucial to identify the elements that will motivate them to visit a theme park. Therefore, this study is being undertaken to identify the variables that affect visitors' intentions to visit theme parks in Malaysia. To benefit local communities, residents, and international visitors, this issue needs to be addressed in the tourism and academic sectors.

## **SIGNIFICANCE OF THE STUDY**

### **LITERATURE REVIEW**

Over the past several decades, philosophers have become concerned with the topic of intention (Cohen and Levesque, 1990). Numerous studies have investigated the nature and function of intent (Anscombe, 1957; Bratman, 1987; Fishbein and Jajzez, 1977; Levelt, 1993). Intention could be defined as the desires of a person to achieve a goal (Ajzen, 1991). Cohen and Levesque (1990) proposed that intention is typically studied separately from other terms such as belief and knowledge, which are typically viewed as propositions, whereas intention is typically viewed as action. The term purchase intention (Liu, 2015) could be used to characterise a customer's intent when making a purchase decision. According to Ajzen and Fishbein (1980), purchase intention is the customer's preparedness and desire to ingest a specific product or service. Purchase intention and purchase behaviour are interrelated, with Eagly and Chaiken (1993) stating that purchase intention represents a person's motivation to extend purchase behaviour.

Other researchers, such as Schiffman and Kanuk (2000), concurred that purchase intention is a person's propensity to engage in purchasing behaviour. Numerous researchers have examined purchase intention in the marketing and economics disciplines, and Morwitz (2021) suggests that purchase intention may be a common measurement in marketing and economics. In the meantime, market importance is placed on purchase intent (Agarwal and Teas, 2002). Purchase intent is significant to the market because it can be used as a predictor to estimate future customer demand (Armstrong, Morwitz, & Kumar, 2000).

Intention is a person's propensity to engage in purchasing behaviour. Numerous researchers have examined purchase intention in the marketing and economics disciplines, and Morwitz (2021) suggests that purchase intention may be a common measurement in marketing and economics. In the meantime, market importance is placed on purchase intent (Agarwal and Teas, 2002). Purchase intent is significant to the market because it can be used as a predictor to estimate future customer demand (Armstrong, Morwitz, & Kumar, 2000).

According to Schlosser (2003), purchase intent is the consumer's evaluation of their own purchasing behaviour. Many factors, such as product presentation, temperament, and perceived risk, influence purchase intention (Park, Lennon, and Stoel, 2005; Park and Stoel, 2002). Swinyard (1993) conducted a study on the purchasing experience and found that customers pay more attention to purchases when they have a positive store experience in terms of an engaging store exhibit, compared to customers who have a negative store experience. Customers also tend to make larger purchases when in a good mood (Bitner, 1992).

In addition, Bennett and Harrel (1975) proposed that confidence can be a predictor of purchase intention and that a reduction in perceived risk can increase consumers' purchase intent. By focusing on tourism and hospitality studies, visit intention is a term that has been used to investigate customer and tourist behaviour (Han, Hsu, and Sheu, 2010; Kozak, 2001; Ng, Lee, and Soutar, 2007). However, studies on the concept of visit intention for tourism and hospitality products are scarce (Jang, Bai, Hu, and Wu, 2009; Wu, 2015).

According to Jang, Bai, Hu, and Wu (2009), visit intention is an individual's intention or commitment to travel. In other words, visit intention is the propensity of a tourist to visit a specific destination (Abubakar and Iikan, 2016; Chen, Shang, & Li, 2014).



Additionally, Wu (2015) supported the visit to a particular location. In fact, visit intention is crucial because it serves as a link between travel motivation and future travel behaviour (Jang, Bai, Hu, & Wu, 2009). Jang, Bai, Hu, and Wu (2009) had previously demonstrated that visit intention can contribute to an activity and transform motivation into behaviour. Therefore, it is essential to investigate visit intention, as it benefits the tourism and hospitality industries (Lam and Hsu, 2006).

### **Research Hypothesis**

RH1: There is a significant relationship between motivation and Malaysia tourist's visit intention.

RH2: There is a significant relationship between attitude and Malaysia tourist's visit intention.

RH3: There is a significant relationship between preferences and Malaysia tourist's visit intention.

## Research Framework

By referencing the literature review, a research framework has been developed to examine the relationship between the factors and travellers' intentions to visit. The proposed conceptual framework would be depicted in Figure 2.3 below. The proposed independent variables consist of four components: motivation, attitude, and preference. while the only dependent variable is the intention of tourists to travel.

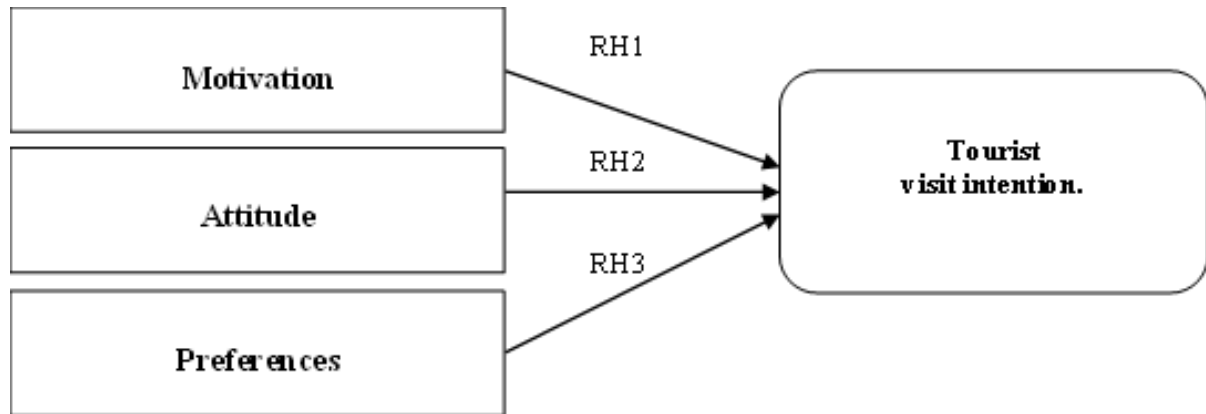

Figure 2. 1: Conceptual Framework of the study

## METHODOLOGY

### Research Design

The broad strategy for conducting a study to look into testable research topics of interest is known as the research design. Researchers will utilize a quantitative design in this study, which is a formal, objective, systematic approach that uses numerical data to gather information. According to Bum and Grove (2010), this research methodology is used to characterize variables, analyze correlations between variables, and identify cause-and-effect interactions between variables.

## Data Collection

As the primary method of data collection for this study, questionnaires will be used. In Malaysia, a convenient distribution technique will be used to provide the questionnaire directly to pertinent respondents who are also the target demographic. This method is the best way to get the most sincere and accurate data from respondent as they are not influence by any circumstances including by the researchers. Besides, this method enable questionnaire to be carried out in a faster pace compared to other data collection method such as interviewing. Moreover, by understanding the important and concern of respondent's privacy, every answer and opinion made will be kept anonymous. The questionnaire will be provided to respondent.

The Likert scale consists of 5 choices of scale. The purpose of choosing 5 Likert scale is to avoid bias where according to Toner (1987), respondent have the tendency to say "Yes" indiscriminately in answer to questions provided to them and this can cause a serious problem. To avoid such problems in the future, researchers might use forced-choice scales which also called as Likert-type scale.

Table 3. 2: Likert-Type Scale Table

Strongly disagree	Disagree	Neutral	Agree	Strongly Agree
(1)	(2)	(3)	(4)	(5)

Sources: Likert-Type Scale Table (Toner,1987)

## Sampling

This study's sample strategy used a non-probability convenience sampling method. Instead of choosing from the complete populations, the researchers can use this sampling strategy to select any of their preferred respondents who are available. Due to some members in the population does not have chance to be sampled, the use of convenience sampling regardless of the size of sample, it can represent the entire population that cannot be known. By using this convenient sampling method, the researchers can distribute the questionnaire easier to collect the data.

## **Data Analysis**

Shamoo and Resnik (2003) state that various analytical techniques "offer a way of drawing inductive inferences from data and differentiating the signal (the phenomenon of interest) from the noise (statistical fluctuations contained in the data)". Data analysis, by definition, is the process of analysing data. Statistical Package for the Social Sciences will be used to analyse the data that has been obtained (SPSS). The programming language SPSS is used to carry out statistical analysis. It is a piece of software that illustrates how independent and dependent variables relate to one another when using the regression, correlation, or factor analysis methods. On the other hand, it is a very convenient and straightforward method for the researchers to transmit the respondent's responses with the appropriate coding before being converted into a data file for the subsequent analysis methods.

## FINDINGS

The demographic profile provided in the questionnaire, as well as the mean and average mean of the dependent and independent variables, are all described using descriptive analysis. A straightforward quantitative presentation of the gathered data set is what is implied by descriptive analysis. It assists the researcher in fully comprehending the experiment or data set and provides all necessary context-setting information.

249 respondents were the respondents we used for the data analysis. The correlation of the data collection is shown in table 1.

Table 1 show the correlation of the data collection.  
 \*\*Correlation is significant at the 0.01 level (2-tailed)

		INTENTION	MOTIVATION	PREFERENCE	ATTITUDE
INTENTION	Pearson Correlation	1	.733**	.733**	.749**
	Sig. (2-tailed)		0	0	0
	N	349	349	349	349
MOTIVATION	Pearson Correlation	.733**	1	.766**	.722**
	Sig. (2-tailed)	0		0	0
	N	349	349	349	349
PREFERENCE	Pearson Correlation	.733**	.766**	1	.794**
	Sig. (2-tailed)	0	0		0
	N	349	349	349	349
ATTITUDE	Pearson Correlation	.749**	.722**	.794**	1
	Sig. (2-tailed)	0	0	0	
	N	349	349	349	349

\*\* Correlation is significant at the 0.01 level (2-tailed).

### Motivation

Research objective 1, research question 1, and hypothesis 1 are provided in Table 5.1. According to hypothesis H1, there is a considerable correlation between visitor intention and motivation. According to the findings of Pearson's correlation analysis (table 4.13), the first independent variable, motivation, had a strong positive association with the dependent variable, intention to visit. H1 is therefore approved. This is in reference to Pearson's correlation coefficient, whose r-value of 0.733 indicated a positive association between motivation and visit intention.

Table 5. 1: Research Objective 1, Research Question 1, And Hypothesis 1

No	Research objective	Research question
1	To access the factors attribute to the Malaysia tourist visit intention toward theme park in Malaysia	What are the factors attributed to the Malaysia Tourist visit intention toward theme parks in Malaysia?
H1- There is a significant relationship between motivation and tourist visit intention		

To conclude, the research objective, which is “What is the relationship of tourist motivation towards theme parks visit intention in Malaysia” achieved. While the research question, which is “What is the relationship of tourist motivation towards theme parks visit intention in Malaysia?” is answered.

### Attitude

Research question 2 and hypothesis 2 are provided in Table 5.2. According to H2, there is a considerable correlation between attitude and tourist intention. According to the findings of Pearson's correlation analysis (table 4.14), the independent variable (attitude) and the dependent variable (intention to visit) showed the strongest positive relationships. H2 is therefore approved. This is in reference to Pearson's correlation coefficient, whose r-value of 0.749 indicated a positive association between attitude and visitation intention.

Table 5. 2: Research Objective 2, Research Question 2, And Hypothesis 2

No	Research objective	Research question
2	What is the relationship of tourist attitude towards theme parks visit intention in Malaysia.	What is the relationship of tourist attitude towards theme parks visit intention in Malaysia?
H2- There is a significant relationship between attitude and tourist visit intention		

To conclude, the research objective, which is “What is the relationship of tourist attitude towards theme parks visit intention in Malaysia” achieved. While the research question, which is “What is the relationship of tourist attitude towards theme parks visit intention in Malaysia?” is answered.

## Preference

Research objective 3, research question 3, and hypothesis 3 are displayed in Table 5.3. According to H3, there is a considerable correlation between attitude and tourist intention. According to the findings of Pearson's correlation analysis (table 4.15), the independent variable (preference) and the dependent variable (intention to visit) exhibited a strong positive association. H3 is therefore approved. This is in reference to Pearson's correlation coefficient, whose r-value of 0.733 indicated a positive association between motivation and visit intention.

Table 5. 3: Research Objective 3, Research Question 3, And Hypothesis 3

No	Research objective	Research question
3	To access the the “ideal Theme Park” consider by Malaysia Tourist	What is the “Ideal Theme Park” consider by Malaysia Tourist.

H3- There is a significant relationship between preference and tourist visit intention

To conclude, the research objective, which is “What is the relationship of tourist preference towards theme parks visit intention in Malaysia” achieved. While the research question, which is “What is the relationship of tourist preference towards theme parks visit intention in Malaysia?” is answered.

## DISCUSSION AND RECOMMENDATION

In order to investigate the relationship between the hypotheses about a significant association, such as motivation, attitude, and preference towards visitors in intention to visit theme parks in Malaysia, Pearson's correlation analysis was utilised. In terms of the various hypotheses, the attitude holds the strongest moderately positive correlation ( $r = 0.749$ ,  $p < 0.01$ ), followed by motivation ( $r = 0.733$ ,  $p < 0.01$ ), and preference ( $r = 0.733$ ,  $p < 0.01$ ), both of which have a positive influence on tourists' intentions to visit Malaysian theme parks. Consequently, the outcome demonstrated that all hypotheses states were accepted at a 0.01 significance level.

Table 4. 16: The summary for hypothesis testing in this study.

H	Research objective	Pearson's correlation results
H1	There is a significant relationship between motivation and tourist visit intention to theme parks in Malaysia	supported $r = 0.733$ , $p < 0.01$ ,
H2	There is a significant relationship between attitude and tourist visit intention to theme parks in Malaysia	supported $r = 0.749$ , $p < 0.01$ ,
H3	There is a significant relationship between preference and tourist visit intention to theme parks in Malaysia	supported $r = 0.733$ , $p < 0.01$ ,

The researcher will provide some recommendations in this section that will be useful for future studies. This will guarantee higher-quality research and better results in the future. Additionally, it can aid the tourism sector in developing better future products and services. In this study, the researcher only identified three variables: visit intention (dependent variable), intentions, motivation, attitude, and preferences (independent variables). The independent variable and the dependent variable only have a weakly positive correlation, according to the results of the two variables.

Future research may integrate fresh discoveries by using additional variables, such as price, as an independent variable. Additionally, the design of websites created by tourism operators receives less attention in this study. This is due to the fact that there are numerous ways to book theme parks, including through theme park websites and online travel firms like (booking.com). Future studies may thus add fresh findings in which respondents decide whether to utilise an online travel agency or make reservations directly from a website. The



best theme park is the only benchmark used in the current study to meet the study's objectives. This is due to the fact that a well-known theme park is the place where visitors first enter and has a high standard of amenities and infrastructure; as a result, choosing the greatest theme park is strongly advised if future research need to examine visitor intentions. Researchers are highly recommended to continue collecting data from respondents using quantitative approaches rather than qualitative methods for future studies.

The researcher did advise handing out the questionnaire to respondents in person, though. This is due to the bias introduced by the fact that social media is currently being used in research to distribute surveys to respondents. The researcher can gather more data from the chosen respondents by handing out the questionnaire in person. The researcher may ask respondents additional questions if the questions and vocabulary are unclear.

Last but not least, the researcher thinks that it would be preferable for future studies if the respondents were visitors who had only visited theme parks. This is due to the fact that visitors have firsthand knowledge of the environment and state of the theme park and can therefore provide a more thorough evaluation. The study's findings will be more reliable if a suitable sample of respondents is chosen.

## **CONCLUSION**

This chapter's conclusion is that there is a significant association between all the variables and tourist visit intention. This demonstrates how the factors had a role in the customer's decision to reserve tickets for Malaysia's greatest amusement park. The variables passed the reliability test, the reliability analysis, and the correlation analysis with scores above 0.7, indicating dependability and suitability for this study. However, because our study was conducted online, the restriction did not stop us from collecting data. Finally, the suggestions made will support further research in this area.

## REFERENCES

- Abd Razaka, A., Shamsudinb, M. F., & Abdul, R. M. (2020). The influence of atmospheric experience on Theme Park Tourist's satisfaction and loyalty in Malaysia. *International Journal of Innovation, Creativity and Change*, 6(9), 20-39
- Abubakar, A. M., and Ilkan, M. (2016). Impact of online WOM on destination trust and intention to travel: A medical tourism perspective. *Journal of Destination Marketing and Management*, 1(1), 1-10.
- Agarwal, S., and Teas, R. K. (2002). Cross-national applicability of a perceived quality model. *Journal of Product and Brand Management*, 11(4), 213-236
- Akter, M., Sadekin, M. N., & Patwary, A. K. (2020). An Empirical Study on Students' Satisfaction from Mawlana Bhashani Science & Technology University, Bangladesh. *Review of Economics and Development Studies*, 6(2), 363-379.
- Al Mahmud, S. R. (2020). The effectiveness of Facebook advertisements on purchase intention of customers in Malaysia. *South Asian Journal of Social Sciences and Humanities*, 1(1), 97-104.
- Alom, S., Patwary, A. K., & Khan, M. M. H. (2019). Factors affecting the turnover intention of Bangladeshi migrants in the United Arab Emirates: An empirical study on the hotel industry. *International Journal of Innovation, Creativity and Change*, 8(3), 344-360.
- Armstrong, J. S., Morwitz, V. G., and Kumar, V. (2000). Sales forecasts for existing consumer products and services: Do purchase intentions contribute to accuracy? *International Journal of Forecasting*, 16(3), 383-397.
- Bagozzi, R. P. (1982). A field investigation of causal relations among cognitions, affect, intentions, and behavior. *Journal of marketing research*, 19(4), 562-583.
- Bagozzi, R. P., and Burkrant, R. E. (1979). Attitude organization and the attitude- behavior relationship. *Journal of personality and social psychology*, 37(6), 913- 929.
- Baloglu, S. (1998). An empirical investigation of attitude theory for tourist destinations: A comparison of visitors and nonvisitors. *Journal of Hospitality and Tourism Research*, 22(3), 211-224.
- Barber, N., Taylor, D. C., and Deale, C. S. (2010). Wine tourism, environmental concerns, and purchase intention. *Journal of Travel and Tourism Marketing*, 27(2), 146-165.
- Bennett, P. D., and Harrell, G. D. (1975). The role of confidence in understanding and predicting buyers' attitudes and purchase intentions. *Journal of Consumer Research*, 2(2), 110-117.
- Chen, Y. C., Shang, R. A., and Li, M. J. (2014). The effects of perceived relevance of travel blogs' content on the behavioral intention to visit a tourist destination. *Computers in Human Behavior*, 30(1), 787-799.
- Cohen, P. R., and Levesque, H. J. (1990). *Intention is choice with commitment*. *Artificial intelligence*, 42(3), 213-261.
- Fengmin, Z., Baijun, W., Jiangtao, B., Li, L., & Patwary, A. K. (2022). Investigating revisit intention of medical tourists in China through nutritional knowledge, perceived medical quality, and trust in the physiologist: A recommendation on health tourism policy measures. *Frontiers in Public Health*, 10, 893497.
- Goodall, B., and Cooper, C. (1991). Understanding holiday choice. *Progress in tourism, recreation and hospitality management*, 3(1), 58-77.
- Goodrich, J. N. (1978). The relationship between preferences for and perceptions of vacation destinations: Application of a choice model. *Journal of Travel research*, 17(2), 8-13.
- Gram, M. (2007). Children as co-decision makers in the family? The case of family holidays. *Young Consumers*, 8(1), 19-28.

- Hazbar, A. M. H., Alem Mohammed, A., & Karim, A. K. A. (2019). An Empirical Study of Factors Influencing hotel customers' online booking Intention. *مجلة العلوم التربوية و الدراسات الإنسانية*, (5), 1-17.
- Hellier, P. K., Geursen, G. M., Carr, R. A., and Rickard, J. A. (2003). Customer repurchase intention: A general structural equation model. *European journal of marketing*, 37(12), 1762-1800.
- Hsu, C. H., Cai, L. A., and Li, M. (2009). Expectation, motivation, and attitude: A tourist behavioral model. *Journal of travel research*, 49(3), 282-296.
- Imada, T., and Kitayama, S. (2010). Social eyes and choice justification: Culture and dissonance revisited. *Social Cognition*, 28(5), 589-608.
- Jang, S. S., Bai, B., Hu, C., and Wu, C. M. E. (2009). Affect, travel motivation, and travel intention: A senior market. *Journal of Hospitality and Tourism Research*, 33(1), 51-73.
- Klenosky, D. B. (2002). The pull of tourism destinations: A means-end investigation. *Journal of Travel Research*, 40(4), 396-403.
- Kozak, M. (2001). Repeaters' behavior at two distinct destinations. *Annals of tourism research*, 28(3), 784-807.
- Krejcie, R. V., and Morgan, D. W. (1970). *Determining sample size for research Educational and Psychological Measurement*, 30(3), 607-610.
- Lee, S., Jeong, E., & Qu, K. (2020). Exploring theme park visitors' experience on satisfaction and revisit intention: A Utilization of experience economy model. *Journal of Quality Assurance in Hospitality & Tourism*, 21(4), 474-497.
- Leon, A. C., Davis, L. L., and Kramer, H. C. (2011). The role and interpretation of pilot studies in clinical research. *Journal of psychiatric research*, 45(5), 626-629.
- Levelt, W. J. (1993). *Speaking: From intention to articulation*. London: MIT press.
- Lewin, K. (1943). Defining the 'field at a given time'. *Psychological review*, 50(3), 292-310.
- Li, L., Ragavan, N. A., Patwary, A. K., & Baijun, W. (2022). Measuring patients' satisfaction toward health tourism in Malaysia through hospital environment, nutritional advice, and perceived value: A study on Chinese exchange students. *Frontiers in public health*, 10, 893439.
- Li, L., Wu, B., & Patwary, A. K. (2022). How marine tourism promote financial development in sustainable economy: new evidences from South Asia and implications to future tourism students. *Environmental Science and Pollution Research*, 29, 1155-1172.
- Li, L., Wu, B., & Patwary, A. K. (2022). The psychosocial factors affecting chinese Outbound Exchange and mobility students' academic performance during COVID-19. *Frontiers in psychology*, 13, 872516.
- McClung, G. W. (2012). Theme park selection: factors influencing attendance. *Tourism Management*, 12(2), 132-140.
- Nayga, R. M., Lipinski, D., and Savur, N. (1998). Consumers' use of nutritional labels while food shopping and at home. *Journal of Consumer Affairs*, 32(1), 106-120.
- Nayga, R. M., Lipinski, D., and Savur, N. (1998). Consumers' use of nutritional labels while food shopping and at home. *Journal of Consumer Affairs*, 32(1), 106-120.
- Ng, S. I., Lee, J. A., and Soutar, G. N. (2007). Tourists' intention to visit a country: The impact of cultural distance. *Tourism management*, 28(6), 1497-1506.
- Oh, J. E., & Kong, A. (2022). VR and Nostalgia: Using Animation in Theme Parks to Enhance Visitor Engagement. *Journal of Promotion Management*, 28(2), 113-127;
- Parinello, and R., G. (1993). Motivation and anticipation in post industrial tourism. *Annals of Tourism Research*, 20(2), 233-249.
- Parinello, and R., G. (1993). Motivation and anticipation in post industrial tourism. *Annals of Tourism Research*, 20(2), 233-249.

- Park, J. H., and Stoel, L. (2002). Apparel shopping on the Internet: Information availability on US apparel merchant Web sites. *Journal of Fashion Marketing and Management: An International Journal*, 6(2), 158-176.
- Park, J. H., and Stoel, L. (2002). Apparel shopping on the Internet: Information availability on US apparel merchant Web sites. *Journal of Fashion Marketing and Management: An International Journal*, 6(2), 158-176.
- Park, J., Lennon, S. J., and Stoel, L. (2005). On-line product presentation: Effects on mood, perceived risk, and purchase intention. *Psychology and Marketing*, 22(9), 695-719.
- Patwary, A. K., Roy, B., Hoque, R., & Khandakar, M. S. A. (2019). Process of developing a community based tourism and identifying its economic and social impacts: An Empirical study on Cox's Bazar, Bangladesh. *Pakistan Journal of Humanities and Social Sciences*, 7(1), 1-13.
- Pesonen, J., Komppula, R., Kronenberg, C., and Peters, M. (2011). Understanding the relationship between push and pull motivations in rural tourism. *Tourism Review*, 66(3), 32-49.
- Ragheb, M. G., and Tate, R. L. (1993). A behavioural model of leisure participation, based on leisure attitude, motivation and satisfaction. *Leisure Studies*, 12(1), 61-70.
- Reibstein, D. J., Lovelock, C. H., and Dobson, R. P. (1980). The direction of causality between perceptions, affect, and behavior: An application to travel behavior. *Journal of Consumer Research*, 6(4), 370-376.
- Reibstein, D. J., Lovelock, C. H., and Dobson, R. P. (1980). The direction of causality between perceptions, affect, and behavior: An application to travel behavior. *Journal of Consumer Research*, 6(4), 370-376.
- Schlosser, A. E. (2003). Experiencing products in the virtual world: the role of goal and imagery in influencing attitudes versus purchase intentions. *Journal of Consumer Research*, 30(2), 184-198.
- Schlosser, A. E. (2003). Experiencing products in the virtual world: the role of goal and imagery in influencing attitudes versus purchase intentions. *Journal of Consumer Research*, 30(2), 184-198.
- Shinde, K. A. (2021). Religious theme parks as tourist attraction systems. *Journal of Heritage Tourism*, 16(3), 281-299.
- Sirakaya, E., Petrick, J., and Choi, H.-S. (2004). The role of mood on tourism product evaluations. *Annals of Tourism Research*, 31(3), 517-539.
- Spies, K., Hesse, F., and Loesch, K. (1997). Store atmosphere, mood and purchasing behavior. *International Journal of Research in Marketing*, 14(1), 1-17.
- Sumethokula, P., Patwary, A. K., Srinuanpanc, B., Srinuanpand, C., Suwandee, P., Thammathikul, A., & Phanong, W. (2020). The potential of new tour repackaging for creative tourism among entrepreneurs in Nakhon Si Thammarat. *International Journal of Innovation, Creativity and Change*, 13(10), 1752-1771.
- Toner, B. (1987). The impact of agreement bias on the ranking of questionnaire response. *The Journal of social psychology*, 127(2), 221-222.
- Urosevic, N. (2010). The effects of including the cultural sector in the tourist product of destination-strategic considerations regarding stria as the region of cultural tourism and pula as the European capital of culture. *Tourism and Hospitality Management*, 1(1), 1305-1317.
- Uysal, M., McGhee, N. G., and Loker-Murphy, L. (1996). The Australian international pleasure travel market: Motivations from a gendered perspective. *Journal of Tourism Studies*, 7(1), 45-57.
- Uysal, M.R., Jurowski, C. (1994). Testing the push and pull factors. *Annals of Tourism Research*, 21(4), 844-846,

- Wahlers, R. G., and Etzel, M. J. (1985). Vacation preference as a manifestation of optimal stimulation and lifestyle experience. *Journal of Leisure Research*, 17(4), 283-295.
- Wahyudi, W. (2022). Five components of work motivation in the achievement of lecturer performance. *Scientific Journal of Reflection: Economic, Accounting, Management and Business*, 5(2), 466-473.
- Wang, Y., LO, H. P., Chi, R., and Yang, Y. (2004). An integrated framework for customer value and customer-relationship-management performance: customer-based perspective from China. *Managing Service Quality: An Interational Journal*, 14(3), 169-182.
- Williams, T. G. (2002). Social class influences on purchase evaluation criteria. *Journal of consumer marketing*, 19(3), 249-276.
- Wu, B., Liu, S., Wang, J., Tahir, S., & Patwary, A. K. (2021). Assessing the mechanism of energy efficiency and energy poverty alleviation based on environmental regulation policy measures. *Environmental Science and Pollution Research*, 28, 40858-40870.
- Wu, B., Zhai, B., Mu, H., Peng, X., Wang, C., & Patwary, A. K. (2021). Evaluating an economic application of renewable generated hydrogen: A way forward for green economic performance and policy measures. *Environmental Science and Pollution Research*, 1-15.
- Wu, C. W. (2015). Foreign tourists' intentions in visiting leisure farms. *Journal of Business Research*, 68(4), 757-762.
- Yoon, Y., and Uysal, M. (2005). An examination of the effects of motivation and satisfaction on destination loyalty: a structural model. *Tourism Management*, 26(1), 45-56.
- Yuan, S., and McDonald, C. (1990). Motivational determinates of international pleasure time. *Journal of Travel Research*, 29(1), 42-44.

## **Factors that influence customer satisfaction in 3star hotels in Kelantan**

*Kasturi A/P Ragunathan, Lee Sook Yee, Melissa Anak Henry, Mohamad Asri Bin Zulkifli  
Amin, Nur Azimah Binti Othman\**

*Faculty of Hospitality, Tourism and Wellness, University Malaysia Kelantan  
Corresponding email: [h20a1180@siswa.umk.edu.my](mailto:h20a1180@siswa.umk.edu.my), [h20a1188@siswa.umk.edu.my](mailto:h20a1188@siswa.umk.edu.my),  
[h20a1204@siswa.umk.edu.my](mailto:h20a1204@siswa.umk.edu.my), [h20a1212@siswa.umk.edu.my](mailto:h20a1212@siswa.umk.edu.my)*

---

### **ABSTRACT**

The study aimed to reveal the indicators that factors that influence customer satisfaction towards service quality in 3-star hotels in Kelantan. A survey was carried out and a total number of 384 respondents was completing the questionnaires which is consisted overall 38 questions. The result showed the customer satisfaction that fulfil their necessary and feelings are based on “service quality” and the several factors such as “price”, “ambiance” and “location”. Hence, any factors must be addressed appropriately in order to maintain a high level of customer satisfaction and the image of the hotel intact. Furthermore, customers from different subgroups have different feelings on the service quality. In this study, questionnaires were distributed to customers from different segments. The aim was to investigate the factors that influences the customer satisfaction towards service quality in 3-star hotels in Kelantan. The research also tested the mediating effect on customer satisfaction based on the service quality that provided. Thus, the results demonstrated a need for better service quality to create satisfaction from customers to those factors that fail to generate customer satisfaction based on the investigation.

**Keywords:** Hotels, Price, Ambiance, Location

---

### **INTRODUCTION**

Hospitality is a contemporary human interaction that is designed to enhance the mutual wellbeing of one another (Brotherton and Wood 2000). In the context of the hospitality industry, the term "hospitality industry" describes a wide range of institutions and departments related to accommodation, food and beverage, travel and tourism, meeting and event, and recreation (MA Ferdous, S Mim, 2021).

The hotel industry is defining all forms of business which are related to a provision. For instance, accommodation in lodging, food and beverage and also other services provided connect and form the public service. Hotels in Kelantan are provided with extra health and safety measures. For example, hotels such as “The Grand Renai”, “Perdana Kota Bharu”,

“Tanjong Inn”, “OYO 90274” “Wadi Isfa Inn” etc. These kinds of hotels are recommended as the best hotel in Kelantan (Tripadvisor,2014).

According to a review of a 5-star hotel which is Perdana Kota Bharu, the reviewer 2022 gave the hotel a 2-star rating to them due to reasons such as the ambiance and structure of the room does not suit the ambiance of a 5-star hotel. The reviewer mentions the room was dingy and furnished very shabbily with old wooden furniture (TripAdvisor, 2022). According to a study by Steffy (1990), this leads to customer satisfaction in hotel environments when lighting is structured to blend in with furnishings and decorations as well as the pleasing aroma that guests detect. However, in some situations where the lighting is unsuited or the scent in the hotel environment is unpleasant with other room elements, this can cause customer dissatisfaction or impacted customer spendings.

Hotels will decide to situate nearby another hotel with comparable features to profit from the external economies of all businesses operating in the same location (Adam, Mensah, 2014). The 3-star hotel has been mentioned earlier, Ibis Styles Hotel Kota Bharu is 1.5 km from tourist spots such as the Handicraft Village and Craft Museum. The hotel is located exactly in the strategic location at the centre of Kota Bharu. In an interview with a reporter from a U.S. economics journal, Conrad N. Hilton, the previous owner of Hilton hotels, emphasized that location is the top, second, and third most crucial aspect for a hotel's success (Park and Min, 2012).

Customer expectation refers to the thoughts and feelings that a customer has. The feelings of customers are required from a product or service they received (Parasuraman Zeithaml and Berry,2018). The expectation that services provided for visitors in 3-star hotels serves as a gauge of consumer satisfaction (Holmes, Ovenden and Wilson,2008, p.28). Customer or customer satisfaction is kind of ill-defined notion, and the actual manifestation of the state of satisfaction varies from person to person or from service to service (Bluestein, Abram, M. Moriarty and R.J. Sanderson,2003). Therefore, the customer’s expectations of hotels are competent services, friendly nature staff, important of 4 courtesies, professional service, etc. It is basically the customer satisfaction that will be shown if the customers will repeat their visitation if they met their expectations based on the above.



## **SIGNIFICANCE OF THE STUDY**

### **Practical**

#### **Hotel Entrepreneur**

Hotel entrepreneur is a person that manages hotel operations and oversees aspects from the hotel workers to the guests. This study will help in finding out the specific information on what the hotel guests are dissatisfied with the hotel and would plan ahead and fix what they lack thereof.

#### **Customer**

A customer is the most significant factor because they would be the ones to buy a firm's product or service. It is the business's job to fulfil the customer's needs and demands. This study will help customers in a way to receive a better service provided by the hotel side. This is due to them improving what they have lack of while back and now learning to take care of their customers better.

#### **Academic**

#### **Researcher**

Researcher is a person that carries out research-based papers. They would be the ones to contribute to society by giving out their ideas and analysing information. The study will help them in utilizing the content of the study effectively by gathering recommendations and experience. There would also be high dissemination of knowledge among them.

## **LITERATURE REVIEW**

“Customer satisfaction” is defining as an analysis of the perceived gap between previous expectations and the product's actual performance (Tse and Wilton,1998, Oliver,1999). It is a subjective, ethereal and complex idea that combines how satisfied and thrilled customers are with the goods and services offered by the company. Customers' happiness with its good and services is said to be the most important factor in determining how competitive and successful the firm is (Henning-Thurau&Klee,1997). Customer satisfaction enhances customers' dependability for a single telecommunications provider. Customer satisfaction in the telecommunications industry can beat out brands by cultivating a long-lasting and lucrative relationship with their clientele (Eshghi, Haughton, and Topi, 2007). Although it is expensive to gain satisfied and devoted clients, doing so would ultimately be advantageous for a business (Anderson, Fornell, and Mazvancheryl, 2004). A business should

be focus to improve their quality of services and charge reasonable prices instead of pleasing their customers (Gustafsson, Johnson, and Roos, 2005). This will help the business keep its clients. It is a well-known fact that more than any other factor, a company's ability to keep customers happy depends on the services and the prices it charges (Turel et al. 2006). Customer engagement is crucial because it raises the satisfaction level when a customer views a product as significant and takes time to research it (Russell Bennett, McColl-Kennedy, and Coote, 2007). Quality is an ambiguous and indistinct construct. A product or service's quality can be assessed based on how well it guarantees total customer satisfaction and how well it is used. According to previous studies, customer service is a set of activities that includes ways to assist consumers, handle complaints promptly, make it simple to file complaints and provide a welcoming environment for authorizing complaints. And service quality is the conclusion of a process of evaluation wherein a client contrasts their expectations with their impressions of the service delivery process and its results. According to Kim, Park, and Jeong, 2004: "Customer service is a set of actions that includes methods for providing support to customers, processing complaints quickly, making it simple to file complaints, and providing a friendly environment for filing complaints."

Price is the sum of all the values that consumers are ready to give up in exchange for a product or service's benefits. The entire number of products or money required to purchase a particular combination of one object and associated services may also be mentioned. According to Kotler and Armstrong (2010), price is the sum of the value customers switched for the advantages of owning or using a good or service while Stanton, Michael, and Bruce (1994) state price are the amount of money or other resources needed to buy a specific mix of one product and its ancillary services is referred to as the price. Price fairness referred to consumer evaluate whether a seller's price is fair or reasonable (Xia et al., 2004; Kukar-Kinney, Xia and Monroe, 2007). Pricing is an important consideration when assessing satisfaction. Reasonable pricing has a positive effect on consumer satisfaction and loyalty. According to prior studies, a customer's choice to accept a certain price has been demonstrated to have an impact on both their level of happiness and loyalty, both directly and indirectly (Martin-Consuegra et al., 2007). According to Herrmann et al., (2007), it was determined that pricing perceptions have a direct impact on customer satisfaction while perceptions of price justice have an indirect impact.

The larger service scape includes ambient conditions, which have been observed to have an impact on customers' pleasure, behavioural intentions, and image. A suitable and

comfortable environment has enhanced customer satisfaction by staying in a hotel. Customers' opinions of the services or brand are improved by positive service reviews and favourable service environment aspirations. Aside from influencing these factors, ambiance can also impact how various clients with various personalities respond (Ebenezer & Akaninyene, 2021). According to Eroglu and Machleit (2001), much research is on the aspects of consumers' behaviour or individual characteristics at the expense of other behavioural facts. Openness to experience is correlated with how active person is in seeking out and appreciating novelty; conscientiousness reflects their likelihood of achieving their goals; extraversion factors show how much and how intensely they interact with others; agreeableness is correlated with their propensity to empathise with others; and neuroticism is correlated with their propensity to experience psychological distress (Mowen, 2000).

Choosing the right strategic location for the hotel is important due to an ideal location is linked to higher demand for accommodations, improved company performance, higher level satisfaction of guests, and the least rate of failure (Xiang and Krawczyk 2016). Once the hotel is constructed, hotel management's strategic marketing must fit into the target market of the surroundings. Factors such as local areas economical condition, zone rules, public properties and services, transit convenience and accessibility, parking facilities, geographic considerations, natural resources, and space are taken into account when choose perfect location for a hotel, correlation can be accomplished in order to maintain the business (Chou, Hsu, and Chen 2008; Gray and Liguori 1998). The hotel's location significantly affects how much its customers enjoy and gain from their experiences while there (Yang et al., 2017). After the strategic location of the hotel is identified, the customer that came to the tourist's attraction must chose the hotel based on their travel itinerary.

## **Research Hypothesis**

**H1: There is a relationship between prices towards customer satisfaction on services quality in 3-Star hotels in Kelantan.**

Price is the sum of all the values that consumers are ready to give up in exchange for a good or service's benefits. The entire number of products or money required to purchase a particular combination of one object and associated services may also be mentioned. According to Kotler and Armstrong (2010), price is the total of what consumers are willing to pay for the benefits of owning or using a good or service while Stanton, Michael, and Bruce (1994) state the amount of money or other resources needed to buy a specific mix of one

product and its ancillary services is referred to as the price. It may also refer to the price paid for a good or service. Price fairness refers to consumer assessments of whether a seller's price is reasonable or fair (Xia et al., 2004; Kukar-Kinney, Xia and Monroe, 2007). Pricing is an important consideration when assessing satisfaction. Reasonable pricing has a positive impact on customer satisfaction and loyalty. It was discovered that customer pricing perceptions have a direct impact on customer happiness, whereas the perception of price equity has an indirect impact. However, the price alone has a big impact on satisfaction.

Customer satisfaction has a strong positive relationship with perceived fairness. In order to satisfy, Oliver and Swan (1989a, b) discovered that the seller's commitment and the worth of the goods and services in comparison to the price had an impact on consumers' views of fairness. The price perception has an impact on consumers satisfaction both directly and indirectly. Al-Msallam (2015), price is playing major role in boosting consumer pleasure because it is believed by experts that customers constantly evaluate services' worth and its price. Campbell (1999) demonstrated that pricing fairness has a significant impact on branded image. As a result, perceived price unfairness may cause consumers to switch brands and spread negative word of mouth. Rothenberger (2015) revealed that customers' negative perception of unfair prices may be a factor in their complaints, decreased repurchasing behaviour, bad word of mouth, and complaints.

## **H2: There is a relationship between ambiance towards customer satisfaction on service quality in 3-Star hotels in Kelantan.**

Staying in a hotel has increased customer satisfaction because of the appropriate and comfortable setting. Positive service ratings and good intentions for the working environment help customers' perceptions of the business or service. Aside from having an impact on these variables, the environment can also affect how distinct clients with different personalities react (E, Ebenezer & Akaninyene, 2021). According to Eroglu and Machleit (2001), despite the detriment of other behavioural facts, many study focuses on the features of consumer behaviour or individual qualities. Extraversion traits reveal how frequently and strongly a person interacts with others, while conscientiousness measures how likely a person is to achieve their goals, agreeableness is correlated the ability to sympathise with others while likelihood of psychological suffering is correlated with neuroticism. Openness to experience is related to how proactive an individual is in seeking out and appreciating novelty (Mowen, 2000).

An essential environmental cue in the hotel sector is ambiances (Jani & Han, 2014, 2015). Jani and Han (2014) examined the atmosphere as a moderator that influenced factors including happiness, hotel image, and overall loyalty that were related to the link between customers' personalities and hotel assessments. They understood the value of hotel ambiance and provided evidence that relationships grew stronger in warm environments. The researcher also mentioned the significance of environments in the hotel industry, where ambience circumstances may influence enhancing customer loyalty.

**H3: There is a relationship between location towards customer satisfaction on service quality in 3-Star hotels in Kelantan.**

The hotel's location has a big influence on how much its visitors enjoy and gain from their stays (Yang, Mao, and Tang, 2017). The customer who visited the tourist attraction must select the hotel depending on their trip plan after the hotel's strategic location has been determined. In accordance with the rule of distance decay, research on tourism and tourism geography has further revealed that hotel location significantly affects visitor movements (Dredge 1999). Facilities nearby may have an impact on the criteria that customers use to select a hotel. Customers can arrange their travel to nearby facilities in advance. The hotel's geographic location predetermines the level of customer activity. The amount of client activity would increase if the hotel were situated in a city, whereas it would decrease if it were situated in a rural location. The latter is the situation involving the geographical obstacle. A gravity spatial allocation paradigm was introduced to examine location satisfaction criteria for residential buildings. Their approach identifies three factors: neighbourhood influence, site attributes, and accessibility (Werczberger and Berechman, 1988). Since it makes financial sense for hotel guests to reduce their time and financial commute expenses, accessibility plays a significant role in both picking a hotel site and being content with it (Yang, Mao and Tang, 2017). The researchers acknowledged that the hotel's location was significant in providing customers with the appropriate level of service.

## Research Framework

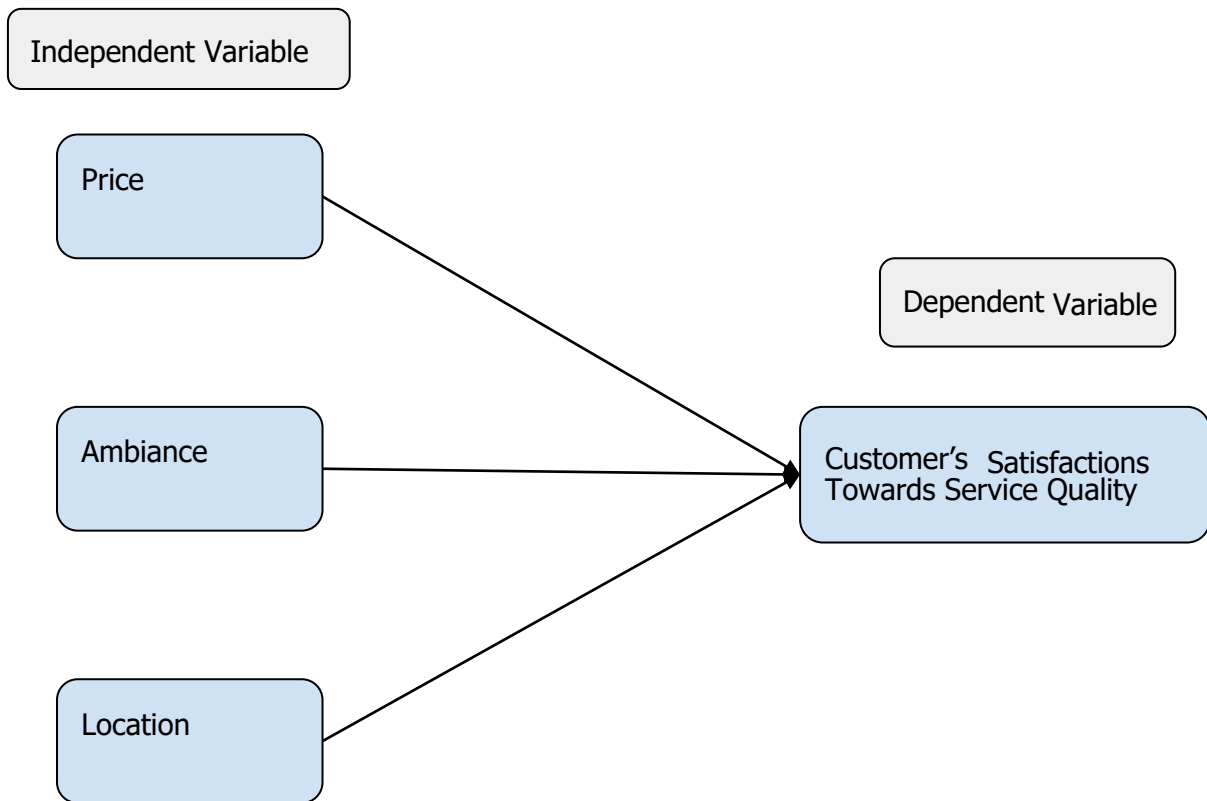

Figure 1: Conceptual Framework

Adapted and adopted from Zelthami and Len Berry (1970), E, Ebenezer & Akaninyene, 2021, and Xiang and Krawczyk 2016)

## METHODOLOGY

### Research Design

A research design is a collection of techniques and steps used to gather and examine data on the variables mentioned in a research challenge. This study uses a cross-sectional design and a quantitative research methodology, in which the researcher gathers all the data at one particular moment. It also examines how guests pick hotels based on the amenities and services they receive. The researcher also consults journals and other papers linked to development to make sure that the choice of hotels based on facilities and equipment in the hospitality sector is appropriately identified.

## **Data Collection**

To gather, measure, and analyses precise study-related data for this investigation, typical data collecting approaches that have been validated are used. A primary questionnaire titled "Factors that Affect Customer Satisfaction with Service Quality in 3-Star Hotels in Kelantan" was used to gather primary data. Researchers had used a site which is Google Form to collect data and choose appropriate respondents to fulfil the questionnaires. The method utilized in this study is simple random sampling, which facilitates the respondents by using a straightforward survey. In the pilot project, 384 questionnaires were created for participants to complete, with instructions on how to explain their responses in light of the assistance they received at the time. The purpose of this pilot study is to gather insightful comments that will help the researcher rewrite and enhance the publishing paper.

## **Sampling**

The accessible participants for this study were chosen from a pool of individuals or employees in the Malaysian hotel business using a non-probability convenience sampling technique. Instead of choosing from the full population, convenience sampling is utilized since it is quicker and less expensive. These surveys, which are generally filled out by students and the general public, must be completed by respondents who subsequently must submit data based on their answers.

## **Data Analysis**

A well-liked computer tool to analyse quantitative data is called the Statistical Package for the Social Sciences (SPSS). It can be used to create tabular reports with graphs and incentive plots and to examine the collected data using the Pearson Correlation Coefficient method. This study intends to determine the connection between organisational fairness, limitations, trust, work autonomy, and employee performance as well as to assess the relationship between the independent variable (IV) and dependent variables (DV).

## **FINDINGS**

This study discussed the results of the data analysis that was done on the data obtained from the survey. The data collected from 384 respondents were analysed to examine the factors that influence customer satisfaction towards service quality in 3-star hotel in Kelantan. Besides

that, the researchers were able to test the hypothesis and answer the research objective of the study.

### Demographic Profile

The demographics collected include gender, race, age, marital status, occupation and how often do they stay in hotels in Kelantan. The result showed the major respondents are female with 274 respondents. Followed by race which is the majority of them are Malay with 156 respondents. Next, we have the age of the respondent mostly were 21-30 years old for 210 respondents which could be explain that this is their prime time in visiting other places whilst staying in Kelantan hotel. Most of the respondents are single and unmarried for 262 respondents which is could be that they have more freedom to move without anyone holding them back. Furthermore, most of them are students too for 192 respondents. The number of how often they stay in hotel in Kelantan most answered were less than 1 time or had stayed once would be 169 respondents. Therefore, most of the students that stayed in hotel once could be choosing hotels as an alternative for a quick pit stop.

### Descriptive Statistic

Figure 2 shows the total mean score and standard deviation of the variables for the independent variables which were price, ambience and locations while the dependent variable would be Customer Satisfaction based on service quality. For independent variable, the total of mean scores and standard deviations would be ambience (mean=3.64, SD=1.03). The following would be price (mean=3.48, SD=0.97) and the lowest of them would be location (mean=3.59, SD=0.95). The dependent variable which is the customer satisfaction based on service quality (mean=3.41, SD=0.73). In conclusion, ambience has the most influence on the customer satisfaction based on service quality.

**Table 1:** Total Mean Scores and Standard Deviation

VARIABLES	N	MEAN	STANDARD DEVIATION
Price	384	3.48	0.97
Ambiance	384	3.64	1.03



Location	384	3.59	0.95
Customer Satisfaction Based on Service Quality	384	3.41	0.73

### Reliability Test

The Cronbach's Alpha Coefficient test are to see whether the study is reliable or not. Based on Figure 3, it shows price has Cronbach's value of 0.829. The second variable is ambience with Cronbach's value of 0.932 followed by the last independent variable which is location for Cronbach's value of 0.94. The dependent variable, service quality Cronbach's value would be 0.92. All four variables are considered consistent and therefore are reliable to use in this study.

**Table 2:** Results of Cronbach's Alpha Coefficient of price, ambience and location and customer satisfaction on Service Quality in 3-Star hotels in Kelantan.

Independent Variable	Dependant Variable	Number of Items
	Customer's Satisfaction Towards Service Quality	
Price	0.829	10
Ambience	0.932	10
Location	0.94	8
Service Quality	0.92	10

### Pearson Correlation

Figure 4, hypothesis 1 illustrates the relationship between price and customer satisfaction on service quality in 3-Star hotels in Kelantan. The correlation coefficient of 0.580 suggested a moderate positive relationship between price towards customer satisfaction on service quality in 3-Star hotels in Kelantan. The p-value of food price is 0.000 which is less than the highly significant level of 0.001. Therefore, there is a significant relationship between price towards customer satisfaction on service quality in 3-Star hotels in Kelantan.

Hypothesis 2 illustrates the relationship between ambience towards customer satisfaction on service quality in 3-Star hotels in Kelantan. The correlation coefficient of 0.596 suggested a moderate positive relationship ambience towards customer satisfaction on service quality in 3-Star hotels in Kelantan. The p-value of food price is 0.000 which is less than the highly significant level of 0.001. Therefore, there is a significant relationship between ambience towards customer satisfaction on service quality in 3-Star hotels in Kelantan.

Hypothesis 3 illustrates the relationship between location and customer satisfaction on service quality in 3-Star hotels in Kelantan. The correlation coefficient of 0.384 suggested a weak but definite relationship between location and customer satisfaction on service quality in 3-Star hotels in Kelantan. The p-value of food price is 0.000 which is less than the highly significant level of 0.001. Therefore, there is a significant relationship between location and customer satisfaction on service quality in 3-Star hotels in Kelantan.

**Table 3:** Pearson Correlation of price, ambience and location and customer satisfaction on Service Quality in 3-Star hotels in Kelantan.

Independent Variable	Dependant Variable Customer's Satisfaction Towards Service Quality	p-value
Price	0.829	0.000
Ambience	0.932	0.000
Location	0.94	0.000

## DISCUSSION AND RECOMMENDATION

**H1:** There is a relationship between price towards customer satisfaction on service quality in 3-Star hotels in Kelantan.

The result for hypothesis 1 has a positive influence on each other due to price fairness can influence guests' perception of value for their money. Xia (2007), price fairness is whether a sellers' price is reasonable or fair that evaluate by consumers. If price fairness does not apply here, the tendency to switch to other hotel alternatives will be high because nowadays it is easily accessible (Abrate, 2012) Having access to online booking applications in their smartphone helps customers in making the right decision.

**H2:** There is a relationship between ambiance towards customer satisfaction on service quality in 3-Star hotels in Kelantan.

The result for hypothesis 2 has a positive influence on each other because of the inclination of guests to stay in a hotel could depend on the ambiance the hotel exudes. Jani and Han (2014) looked into ambiance as a moderator that affected the connection between guests' personalities and hotel assessments such as contentment, hotel images, and overall loyalties. The role of the human five senses in making deductions on projecting the correct ambiance are significant to their satisfaction. D'Astuous (2000) mentioned in his study that ambiance affected the five senses by defining the ambiance is a term used to describe conditions in the backdrop of an environment that are below the level of immediate consciousness.

**H3:** There is a relationship between location towards customer satisfaction on service quality in 3-Star hotels in Kelantan.

The result for hypothesis 3 shows a positive influence on each other due to the accessibility of the hotel to the place of their desired destination. Xiang and Krawczyk (2016). The accessibility of a hotel, such as the distance from urban area and tourist attractions is typically correlated with its location. The hotel may be located where transportation would be available for them 24/7 and is safe for them. Enz (2009) discovered a direct relationship between a hotel's location and its level of security and safety.

One of the recommendations that can be done to overcome customer origin is to increase the sample size from different states by not just specific in the Kelantan area. The researcher believes that customers who came from different states will have different perceptions when they answer the questionnaire and may have relied on the perception of the customers. This is because the customers that went to 3-Star hotel are not just people that live in Kelantan, but we must consider the population from different states in Malaysia that came to Kelantan as tourists.

Other than that, limit the age of the respondents to only 18 and above to answer the questionnaire. This is because respondents at 18-year-olds and below did not have income to support the fees such as hotel fees and amenities just yet. It is advised that future research expand the age range of the sample to increase the generalizability of the findings based on the

study's findings. This can be accomplished by actively seeking out and recruiting individuals from a larger age range to ensure representation across all life phases.

The next one should use qualitative methods in collecting data from respondents. This is because some respondents lacked the necessary information to complete the survey. Some of them would rather have an interview session. It's suggested for future research to consider other factors other than price, ambience, and location in influencing customer satisfaction of service quality in 3-Star hotels in Kelantan. The hotel facility or the type of room provided by the hotel could be made as one of the variables because it has the efficiency of helping understanding factors affecting hotel customer satisfaction.

On top of that, to deal with the respondents who, tend to answer neutral in the questionnaire would be to give up on the possibility of neutral option. This way, the respondents will be forced to choose a definite answer one way or another. The researcher may want to opt for a more accurate mode of Likert-scale questionnaire which is by using the seven-point Likert items. 7-point Likert scales are more precise, simpler to use, and a better representation of the real opinion of the respondents

In addition, the researcher may only focus on a single location. In this study, the researcher only focused on the Kelantan area. This limitation has restricted the generalizability of hotels that are in other places with potentially varied customer expectations, cultural influences, and service standards. So, the future research should be testify the effect of geography on the phenomenon under inquiry, according to the study's conclusions.

## **CONCLUSION**

To be conclude, this study carried out to investigate the relationship between price, ambience and location towards customer satisfaction on service quality in 3-Star hotels in Kelantan. The conceptual framework is developed using the reviewed literature. The researcher intended to look into the relationship between the independent and the dependent variables. Survey was conducted via online questionnaire and drew 384 respondents. The data was collected and analysed by usage of descriptive statistics, reliability analysis, and correlation analysis using SPSS software version 28 and 27. The overall variables were 0.9003 as a result of the reliability analysis. As a result, the presented result is trustworthy and can be accepted in this study.

## REFERENCES

- Abdullah F. A., Ismail T. A. T., and Yusoff A. M. (2022). Hotel Ammenities, Customer Satisfaction and Customer Experience: A Test of Mediation. *Journal of Tourism, Hospitality and Culinary Arts*, 14(1), 262-270. <https://ir.uitm.edu.my/68153/1/68153.pdf>
- Akter, M., Sadekin, M. N., & Patwary, A. K. (2020). An Empirical Study on Students' Satisfaction from Mawlana Bhashani Science & Technology University, Bangladesh. *Review of Economics and Development Studies*, 6(2), 363-379.
- Al-Msallam, Samaan, Customer Satisfaction and Brand Loyalty in the Hotel Industry (2015). *International Journal of Management Sciences and Business Research*, Vol. 4, September 2015. and B. Brotherton (eds), *The Sage Handbook of Hospitality Management*, London: Sage, pp. 35–61.
- Alom, S., Patwary, A. K., & Khan, M. M. H. (2019). Factors affecting the turnover intention of Bangladeshi migrants in the United Arab Emirates: An empirical study on the hotel industry. *International Journal of Innovation, Creativity and Change*, 8(3), 344-360.
- Anderson, E.W., Fornell, C., and Mazvancheryl, S.K. (2004), "Customer Satisfaction and Shareholder Value", *Journal of Marketing*, Vol. 68, pg; 172–185.
- Anil, L., et al. (2022). "A comparative study of select demographic variables and job satisfaction of NCR hotels' employees." *International Journal of Hospitality andamp; Tourism Systems* 15(2): 112-122. <https://www.j scholar.in/index.php/index/search/authors/view?firstName=Mohinder&middleName=&lastName=Chand&affiliation=Department%20of%20Tourism%20&%20Hotel%20Management,%20Kurukshetra%20University,%20Kurukshetra,%20Haryana&country=IN>
- Bhuiyan. (2020). *The Impact of Service Quality on Customer Satisfaction in Hotel Business Development*. diva-portal.org. Retrieved January 10, 2023, from <https://www.divaportal.org/smash/get/diva2:1582843/FULLTEXT01.pdf>
- Bluestein, Abram; Michael Moria; Ronald Sanderson (2003). *The Customer Satisfaction Audit*. Axminster: Cambridge Strategy Publications. ISBN 978-1-902433-98-1.
- Campbell, Margaret C. (1999), "Perceptions of Price Unfairness: Antecedents and Consequences," *Journal of Marketing Research*, 36 (May), 187–99.
- Choi, H. and J. Kandampully (2019). "The effect of atmosphere on customer engagement in upscale hotels: An application of S-O-R paradigm." *International Journal of Hospitality Management* 77: 40-50. <https://www.sciencedirect.com/science/article/pii/S0278431917303055>
- Chou Tsung-Yu, Hsu Chia-Lun, Chen Mei-Chyi. 2008. "A Fuzzy Multi-criteria Decision Model for International Tourist Hotels Location Selection." *International Journal of Hospitality Management* 27 (2): 293–301.
- d'Astous, A. (2000, August 1). *Irritating Aspects of the Shopping Environment*. *Journal of Business Research*; Elsevier BV. [https://doi.org/10.1016/s0148-2963\(99\)00002-8](https://doi.org/10.1016/s0148-2963(99)00002-8)

- Dredge Dianne. 1999. "Destination Place Planning and Design." *Annals of Tourism Research* 26 (4): 772–91.
- E, Ebenezer, and Akaninyene . (2021, December). *The Role Of Ambience On Customers' Patronage In Hotel Industry (A Case Study Of Two Hotels In Victoria Island, Lagos)*. GASPRO International Journal of Eminent Scholars. Retrieved January 10, 2023, from <https://www.globalacademicstar.com/download/article/the-role-of-ambience-oncustomers-patronage-in-hotel-industry-a-case-study-of-two-hotels-in-victoria-islandlagos-89957.pdf>
- E, Ebenezer, and Akaninyene . (2021, December). The Role Of Ambience On Customers' Patronage In Hotel Industry (A Case Study Of Two Hotels In Victoria Island, Lagos). GASPRO International Journal of Eminent Scholars. Retrieved January 10, 2023, from <https://www.globalacademicstar.com/download/article/the-role-of-ambience-on-customers-patronage-in-hotel-industry-a-case-study-of-two-hotels-in-victoria-island-lagos-89957.pdf>
- Educational and Psychological Measurement. Electronics and Telecommunications Research Institute, School of Business, Information and Communications University, Yusong-gu, Hwaam-dong, Taejon 305-348, South Korea.
- Enz, C. A. (2009). The physical safety and security features of US hotels. *Cornell Hospitality Quarterly*, 50(4), 553-560, from [https://www.researchgate.net/publication/247784804\\_The\\_Physical\\_Safety\\_and\\_Security\\_Features\\_of\\_US\\_Hotels](https://www.researchgate.net/publication/247784804_The_Physical_Safety_and_Security_Features_of_US_Hotels)
- Eroglu, S. A., Machleit, K. A., & Davis, L. M. (2001, November). Atmospheric qualities of online retailing. *Journal of Business Research*, 54(2), 177–184. [https://doi.org/10.1016/s0148-2963\(99\)00087-9](https://doi.org/10.1016/s0148-2963(99)00087-9)
- Eshghi, A., Houghton, D., and Topi, H., (2007), "Determinants of customer loyalty in the wireless telecommunications industry", *Telecommunications policy*, Volume 31, Issue 2, Pages 93-106.
- Fengmin, Z., Baijun, W., Jiangtao, B., Li, L., & Patwary, A. K. (2022). Investigating revisit intention of medical tourists in China through nutritional knowledge, perceived medical quality, and trust in the physiologist: A recommendation on health tourism policy measures. *Frontiers in Public Health*, 10, 893497.
- Gustafsson, A., Johnson, M.D., and Roos, I. (2005), "The Effects of Customer Satisfaction, Relationship Commitment Dimensions, and Triggers on Customer Retention", *Journal of Marketing*, Vol. 69, pg. 210–218.
- Hamidi, Suaidah and Raston, Nursalihah & Mamun, Abdullah. (2014). Customer Satisfaction Towards Three Star Hotels in Kelantan, Malaysia. *The Social Sciences*. 9. 182-188. 10.3923/sscience.2014.182.188. [https://www.researchgate.net/publication/262376994\\_Customer\\_Satisfaction\\_Towards\\_Three\\_Star\\_Hotels\\_in\\_Kelantan\\_Malaysia](https://www.researchgate.net/publication/262376994_Customer_Satisfaction_Towards_Three_Star_Hotels_in_Kelantan_Malaysia)

- Hazbar, A. M. H., Alem Mohammed, A., & Karim, A. K. A. (2019). An Empirical Study of Factors Influencing hotel customers' online booking Intention. *مجلة العلوم التربوية و الدراسات الإنسانية*, (5), 1-17.
- Hennig-Thurau, T., and Klee, A. (1997), "The Impact of Customer Satisfaction and Relationship Quality on Customer Retention: A Critical Reassessment and Model Development," *Psychology & Marketing*, Vol. 14, Issue 8, Page 737–764.
- Herrmann, Xia, B. Monroe, and Huber. (2007, March 6). The influence of price fairness on customer satisfaction: an empirical test in the context of automobile purchases | Emerald Insight. The Influence of Price Fairness on Customer Satisfaction: An Empirical Test in the Context of Automobile Purchases | Emerald Insight. Retrieved January 9, 2023, from <https://www.emerald.com/insight/content/doi/10.1108/10610420710731151/full/pdf?title=the-influence-of-price-fairness-on-customer-satisfaction-an-empirical-test-in-the-context-of-automobile-purchases>
- Holmes-Smith, P., Coote, L., & Cunningham, E. (2006). *Structural equation modeling: From the fundamentals to advanced topics*. Melbourne: SREAMS <https://journals.sagepub.com/doi/10.1177/10963480211011535>
- Kenton, W., (19 October 2021) Customer: Definition and How to Study Their Behaviour for Marketing. Investopedia. <https://www.investopedia.com/terms/c/customer.asp>
- Kotler, P. & Armstrong, G. (2010), "Principles of Marketing", 13th ed. New Jersey: Prentice Hall.
- Lee, S. and N.-K. Chuang (2022). "Applying Expanded Servicescape to the Hotel Industry." *Journal of Hospitality and Tourism Research* 46(4): 771-796.
- Li, L., Ragavan, N. A., Patwary, A. K., & Baijun, W. (2022). Measuring patients' satisfaction toward health tourism in Malaysia through hospital environment, nutritional advice, and perceived value: A study on Chinese exchange students. *Frontiers in public health*, 10, 893439.
- Li, L., Wu, B., & Patwary, A. K. (2022). How marine tourism promote financial development in sustainable economy: new evidences from South Asia and implications to future tourism students. *Environmental Science and Pollution Research*, 29, 1155-1172.
- Li, L., Wu, B., & Patwary, A. K. (2022). The psychosocial factors affecting chinese Outbound Exchange and mobility students' academic performance during COVID-19. *Frontiers in psychology*, 13, 872516.
- Lundberg, D. (1994) *The Hotel and Restaurant Business*, 6th edn. New York: Van Nostrand Reinhold, 64, 100 <https://www.sciencedirect.com/science/article/pii/S1877042814029553>
- Marsan, J. (1999) Ringing up revenues, hotels. Vol. 33, No. 9 September <https://www.sciencedirect.com/science/article/pii/S1877042814029553>
- Martin-Consuegra, D., Molina, A. and Esteban, A., (2007), "An Integrated Model of Price, Satisfaction and Loyalty: an Empirical Analysis in the Service Sector", *Journal of Product & Brand Management*, Volume. 16, Issue.7, pages. 459–468.

- Oliver, R.L. (1999), “Whence Consumer Loyalty, “The Journal of Marketing, Fundamental Issues and Directions for Marketing, Vol. 63, pp. 33-44.
- Parasuraman, A., Zeithaml, V. A., & Berry, L. L. (1985, January 1). *A Conceptual Model of Service Quality and Its Implications for Future Research*. Journal of Marketing; American Marketing Association. <https://doi.org/10.2307/1251430>
- Patwary, A. K., Roy, B., Hoque, R., & Khandakar, M. S. A. (2019). Process of developing a community based tourism and identifying its economic and social impacts: An Empirical study on Cox’s Bazar, Bangladesh. *Pakistan Journal of Humanities and Social Sciences*, 7(1), 1-13.
- Rothenberger, S. Fairness through transparency: The influence of price transparency on consumer perceptions of price fairness. *Work. Pap. CEB* 2015, 15, 1–37.
- Russell-Bennett, R, McColl-Kennedy, J.R., Coote, L.V. (2007) “Involvement, satisfaction and brand loyalty in a small business services setting”, *Journal of Business Research*, Volume 60, Issue 12, December 2007, Pages 1253-1260.
- Saxena. (2017). *Literature Review on Customer Satisfaction*. International Journal of Advanced Research in Engineering and Management (IJAREM) ISSN: 2456-2033. Retrieved January 8, 2023, from <http://ijarem.org/papers/v3-i1/3.IJAREM-B007.pdf>
- Simplilearn. <https://www.simplilearn.com/what-is-data-collection-article>
- Stanton, W. J., Michael J. E, and Bruce J. W. (1994) *Fundamentals in Marketing*. 10th ed. McGraw-Hill.
- Sumethokula, P., Patwary, A. K., Srinuanpanc, B., Srinuanpand, C., Suwandee, P., Thammathikul, A., & Phanong, W. (2020). The potential of new tour repackaging for creative tourism among entrepreneurs in Nakhon Si Thammarat. *International Journal of Innovation, Creativity and Change*, 13(10), 1752-1771.
- Syaqirah, Z. N., and Faizurrahman, Z. P. (2014). Managing customer retention of hotel industry in Malaysia. *Procedia-Social and Behavioral Sciences*, 130, 379-389 <https://cyberleninka.org/article/n/475888>
- Szyndlar, M.,(17 November, 2022) Customer satisfaction: Why it’s important in 2023. *Survicate*. <https://survicate.com/customer-satisfaction/importance-customer-satisfaction/>
- The 10 Best Hotel Deals in Malaysia (Jun 2023) - Tripadvisor*. (n.d.). <https://www.tripadvisor.com.my/SmartDeals-g293951-Malaysia-Hotel-Deals.html>
- Tse, D., Nicosia, F., & Wilton, P. R. (1990, January 1). *Consumer satisfaction as a process*. Psychology & Marketing; Wiley-Blackwell. <https://doi.org/10.1002/mar.4220070304>
- Tuovilla, A.,(28 May 2020). Sampling: What it is, Different Types, and How Auditors and Marketers use it <https://www.investopedia.com/terms/s/sampling.asp>
- Turel, O., and Serenko, A. (2006), “Satisfaction with mobile services in Canada: An empirical investigation”, *telecommunication policy*, volume 30, issue 5, 6, Pages 314-331.



- Werczberger, E., and J. Berechman. 1988. "Incorporating neighborhood effects into What is Data Collection: Methods, Types, Tools and Techniques. (2 January 2023). Simplilearn. <https://www.simplilearn.com/what-is-data-collection-article>
- What is Data Collection: Methods, Types, Tools and Techniques. (2 January 2023).
- Wu, B., Liu, S., Wang, J., Tahir, S., & Patwary, A. K. (2021). Assessing the mechanism of energy efficiency and energy poverty alleviation based on environmental regulation policy measures. *Environmental Science and Pollution Research*, 28, 40858-40870.
- Wu, B., Zhai, B., Mu, H., Peng, X., Wang, C., & Patwary, A. K. (2021). Evaluating an economic application of renewable generated hydrogen: A way forward for green economic performance and policy measures. *Environmental Science and Pollution Research*, 1-15.
- Xia, L., Monroe, K., & Cox, J. (2004). "The Price Is Unfair! A Conceptual Framework of Price Fairness Perceptions, *Journal of Marketing*, Volume: 68, Issue: 4, Pages: 1-15.
- Xiang Zheng, Krawczyk Matthew. 2016. "What Does Hotel Location Mean for the Online Consumer? Text Analytics Using Online Reviews." In *Information and Communication Technologies in Tourism 2016*. Cham, Switzerland: Springer.
- Yang, Y., Mao, Z., & Tang, J. (2017, February 1). *Understanding Guest Satisfaction with Urban Hotel Location*. *Journal of Travel Research*; SAGE Publishing. <https://doi.org/10.1177/0047287517691153>
- Yang, Y., Mao, Z., & Tang, J. (2018). Understanding Guest Satisfaction with Urban Hotel Location. *Journal of Travel Research*, 57(2), 243–259. <https://doi.org/10.1177/0047287517691153>
- Yao Chang, and Cheng Lin. (2022). *The Effects of Atmosphere on Perceived Values and Customer Satisfaction toward the Theme Hotel: The Moderating Role of Green Practice Perception*. ResearchGate. Retrieved January 10, 2023, from <http://dx.doi.org/10.3390/su14159153>

# Factors that influence customers satisfaction towards robotic service restaurant in Malaysia

*Muhamad Hakimi bin Abdullah, Muhamad Ibad bin Hassan, Muhammad Aiman Hakim bin Zaidi, Muhammad Fahmi bin Amin Husni, Nur Azimah binti Othman\**

*Faculty of Hospitality, Tourism and Wellness, Universiti Malaysia Kelantan*

*Corresponding email:*

---

## ABSTRACT

---

*“The world has been presented with a variety of modernity and technological sophistication that can match human efficiency. Robots are among the technologies that can replace humans in terms of daily work. But to what extent can these advanced robot capabilities meet and give satisfaction to humans in their use, especially in industrial sectors such as the hospitality industry where robots are now increasingly taking over all the tasks that were previously done by humans. Research has shown that there are several factors that influence customer satisfaction towards robotic service restaurants. The purpose of the study is to determine the four main factors in knowing customer satisfaction with robot restaurant services. These four factors are service efficiency, time saving, security and monetary value. For gathering information and data, an online questionnaire has been distributed through social media. Malaysian population is used, and samples have been taken to analyse the data to find answers to this study. Scientific methods are also applied to obtain excellent results along with making this study more practical and useful”.*

---

**Keywords:** Customer Satisfaction, Time Saving, Service Efficiency, Security, Monetary Value

---

## INTRODUCTION

Numerous sectors around the world use robots nowadays, particularly in the restaurant sector of the hospitality industry. Our daily lives now contain many robots (Ferreira, 2017). The restaurant sector makes use of several different kinds of robots. For instance, a cook robot oversees preparing various foods, and a host robot oversees welcome clients to the reception area and directing them to their tables (Lu, 2019). Customers place orders, and a waiter robot brings the food to the tables (Eksiri & Kimura, 2015). In 2014, Aloft Hotels debuted the A.L.O "robotic butler or Botlr" in its Cupertino location, making it the first hotel chain to use robot technology. The robot can deliver packages across the hotel. Robot service is already being used in the restaurant and hotel industries in Arabic. Due in part to the fact that concepts of mechanisation and self-administration are unquestionably playing a key role in the customer experience, restaurant hotel robots in Saudi Arabia have become a popular technological trend within the hospitality industry. The use of robots can lead to improvements in terms of speed, cost effectiveness, and even precision (Insureqlik, 2021). In the core of Dubai's city centre, at Umm Hurair 1, the restaurant known as "Drink and Spice Magic" is the first to employ the services of a robot server named Ruby which is entertains and increases customers satisfaction who visit his restaurant (AirTimes,2018).

The main problem in this research that there is still less use of robot service in Malaysian restaurants because it can have a negative impact on human employment opportunities. In Malaysia, the use of robot service in restaurants can be said to be very unsatisfactory because only some restaurants use the service. Only 50% of restaurants in Malaysia use robot services because some restaurants do not meet the criteria, especially in terms of the size of the premises (Berita Harian et al., 2022). This is evident since robots were unable to perform tasks other than those programmed into their systems.

## **Significance Of the Study**

### **Practical**

This study will help hospitality sector entrepreneurs to build and sustain a good service with a right choice when they want to decide an appropriate service to their customer. In another practical aspect, it will open the eyes of hospitality sector operators to the use of advanced robots from a positive or negative point of view.

### **Academic**

This study reopens the gap of lack of research resources carried out by researchers in matters related to this study and open space for their research to venture and deepen far in their research. Besides, with this study, an increase in related reference materials or similar searches can be accessed by researchers to carry out their future studies where this research will provide information on customer satisfaction and factors also related to the use of robot's service.

## **LITERATURE REVIEW**

### **Service Efficiency**

Robotic service has grown in favor among customers and organizations. A serving robot, a sort of service robot built for the primary purpose of serving and utilized in the restaurant business, is a robot with a limited objective of "serving," as opposed to service robots with a broad range of applications (Jang & Lee, 2021). When the serving robot brings the requested meal to the front of the client's table, the customer places the food on the table himself. The serving robot substitutes the serving that the employee must do, allowing the person to deliver additional high-quality services while enhancing efficiency. It can also give clients with a robot serving attraction and advertising impacts (Park, 2020). Service efficiency (total length and delay time) expectations were considerably different for service-related elements, with carry-out evaluated as the most efficient, followed by human delivery and finally robot delivery. Notably, even though the specific robot for each meal delivery attempt was not monitored, researchers and customer survey participants observed delivery robots frequently halting for significant periods of time. Restaurants may benefit from robotics in a variety of ways, including greater efficiency and production, improved safety and sanitation,

and improved customer service. Furthermore, robots can help free up humans for other activities or even allow organizations to run with fewer personnel.

### **Time Saving**

Robots produce various benefits over human labour, one of which is time savings. Reducing the amount of time required to complete a task, particularly in restaurants where customer happiness is highly impacted, is known as time saving. Robots can work continuously for 7 days a week, providing customers with any services in restaurants without becoming weary. Due to their ability to work continuously and incredibly effectively, robots do not require breaks or vacation days because robots are created to help human jobs (Robotworx, 2021). This allows businesses like restaurants to save time and money while also enhancing the quality and value of their business. With the presence of this robot, it can indirectly reduce the amount of time it takes for human labour to deliver and collect each order from clients by a short amount of time. Given the rise in orders, most restaurants currently employ robot labour since it saves time and gives the establishment an advantage over human labour, which requires more time to move about while performing work in restaurants. As a result, this robot can reduce delivery times overall and may even enable the restaurant to expand. Collaboration between humans and robots can save time and resources on specific jobs (Amanz, 2021). Due to the high number of robot employees, many managers of restaurant use them as staff because there are many advantages obtained from human labour, especially in terms of time saving (Soyacincau, 2021).

### **Monetary Value**

Financial value can also be linked to an agreement in the payment of goods and services according to economic value (Lo & Spash, 2013). Investing in something affects the decision in the portfolio for monetary value (Amendinger et al., 2003). The use of this robot focuses on the customer's reaction as a service value with the advanced technology available on the robot. Blanche et al. (2021). Telemedicine is successfully addressed with the help of robots and robots become an economic option in terms of telemedicine consultation systems. (Jang et al., 2020). This causes telemedicine to affect the demand for the value of money to meet human needs. This robot will also accelerate economic growth through business operations. This robot service is also able to reduce the covid-19 infection for the process of economic recovery to the value of money. The service sector contributes to the economy in monetary value, especially in restaurants with good work results.

### **Security**

Security is the state of being or feeling secure, free of fear, anxiety, danger, and uncertainty. Something that provides or guarantees safety, tranquillity, or certainty, such as protection or safeguard. Security is an outsourced service in which an outside company handles and manages your security because robots can directly perceive and affect the physical world (Webster's New World College, Houghton Mifflin. 2014). Besides, security is especially important in robotics. As autonomous systems interact with humans and robotic systems grow more widespread, the necessity to safeguard these systems becomes crucial. As robots gain

popularity in a wide range of disciplines and applications, increasing emphasis is being placed on the safety and security aspects of robotic performance. The term "safety" typically relates to human-robot interaction or the protection of the robot from physical injury (Jorge Pea Queralt, Qingqing Li, and Tomi Westerlund. 2021). What is commonly overlooked is that the safe operation of an autonomous robot is closely tied to the rigorous security of the data involved includes mission order data.

## **Customers Satisfaction**

Customer satisfaction is defined as the degree to which customers are satisfied with a company's products, services, and capabilities. Customer satisfaction data, such as surveys and ratings, can help a company decide how to improve or modify its products and services. According to the Service robot acceptance model (sRAM) proposed by (Stefanie Palunh, Jochaen Wirtz, Werner H Kunz.2018), in addition to functional components like perceived ease of use and utility influencing customer satisfaction, social-emotional and relational elements are also important factors forming customer satisfaction of service robots (Marketing Metrics, Paul Farris.2010). The number of customers, or proportion of all customers, reporting positive experiences with a company, its goods, or services surpasses predetermined satisfaction goals. Customer satisfaction as a 'person's emotion of joy or disappointment, which comes from measuring a product's perceived performance or outcome versus his/her expectations'. However, in the case of hospitality, experts have proposed that additional criteria may be required to completely explain the adoption of robot technology (Go et al., 2020). For example, may be impressed by the faster service provided by robots (Lee, 2011). Similarly, the novelty of the robot service experience itself may boost client pleasure (Bello and Etzel, 1985; Duman and Mattila, 2005). In restaurants, this means that order wait times can be significantly decreased, perhaps leading to higher customer satisfaction by (Stefanie Paluch, Jochen Wirtz, Werner H Kunz.2018).

## **Research Hypothesis**

1st Hypotheses:

H (1): There is relationship between service efficiency with customers satisfaction towards robotic service restaurant in Malaysia.

The results of hypothesis H1 stated that there is a significant relationship between service efficiency and customer satisfaction toward robotic service in the restaurant industry. From the findings, it shows that it is moderately positive with a correlation coefficient of 0.529 at a p-value of 0.00 which is less than the highly significant level of 0.1. Therefore, H1 is accepted.

## 2nd Hypotheses:

H (2): There is relationship between time saving with customers satisfaction towards robotic service restaurant in Malaysia.

This was answered by reviewing the outcomes of hypothesis H2. According to H2, there is a significant relationship between time saving and customer satisfaction toward robotic service in the restaurant industry. To the findings, the correlation coefficient is 0.689, and the p-value is 0.00, which is less than the highly significant level of 0.1. Therefore, H2 is accepted.

## 3rd Hypotheses:

H (3): There is relationship between security with customers satisfaction towards robotic service restaurant in Malaysia.

To answer this need to review and look at the result of hypothesis 3. H3 mentioned that there is relationship between security with customer satisfaction towards robotic service restaurant in Malaysia. From the findings, it is positive with the correlation coefficient of 0.70 while p value is 0.00 which is less than the highly significance level 0.01. As a result, H3 is accepted.

## 4th Hypotheses:

H (4): There is relationship between monetary value with customers satisfaction towards robotic service restaurant in Malaysia.

To answer RQ4, need to review and look at the result of hypothesis 4. H4 mentioned that there is relationship between monetary value with customer satisfaction towards robotic service restaurant in Malaysia. From the findings, it is positive with the correlation coefficient of 0.68 while p value is 0.00 which is less than the highly significance level 0.01. As a result, H4 is accepted.

## Research Framework

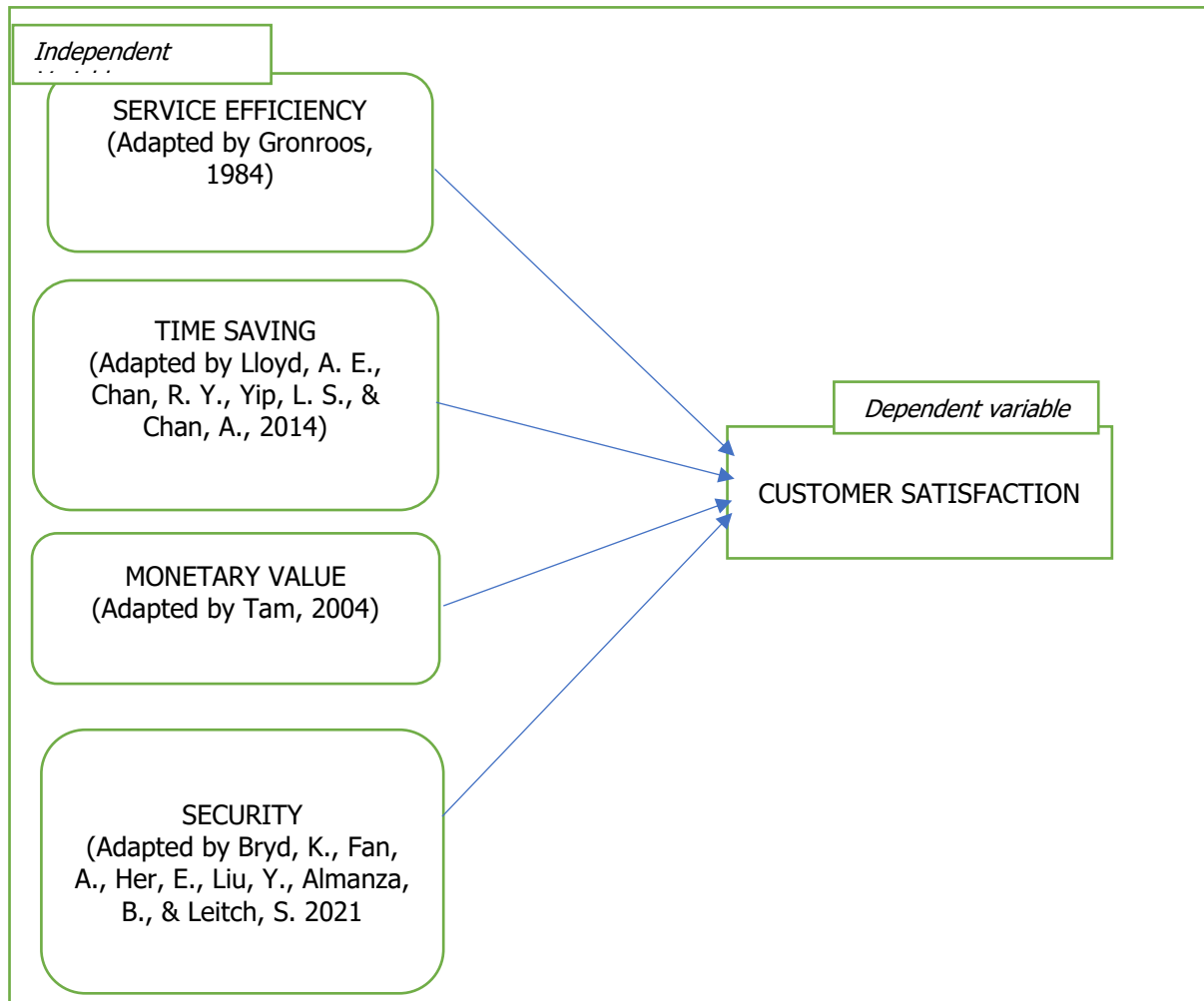

Figure 1 : Conceptual Framework Adapted From Gronroos (1984), (Lloyd, , A. E., Chan, R. Y., Yip, L. S., & Chan, A., 2014), (Tam, 2004), (Byrd, K., Fan, A., Her, E., Liu, Y., Almanza, B., & Leitch, S., 2021)

## METHODOLOGY

### Research Design

In this study, a quantitative method will be used to gain all the data through questionnaires. A good research design aids in the resolution of the research topic. According to Abutabenjeh and Jadara (2018), Babbie (2004) stated that the study design is a plan for the researcher to determine what to observe and analyse, why, and how. To collect all the data for this investigation, a quantitative method is used. The quantitative research method comprises a variety of techniques for conducting systematic investigations of social issues using statistical or numerical data.

## **Data Collection**

This research must clarify the data sources, data types, and methodology used during data collections. For this research, before data can be measured, it could be necessary to analysed once it is collected. For examples, it might be required to change questionnaire and survey results from words to numbers. In this research use Google Form because it easy to obtain responses without to ask face to face. There are random respondents who were chosen to complete the questionnaires or survey were used to collect the data. The questionnaires will be divided into Sections A and B, and they will each be represented in both English and Malay. This questionnaire is about how customers can give answer or perspective about customers satisfaction toward robotics in the restaurant.

## **Sampling**

Sampling is the method used to choose this subgroup from the population, and this subgroup is called as a sample. In this research, sampling method strategies which are probability sampling technique. Probability sampling technique have many techniques, but simple random sampling is suitable for this research. So, in this case the researcher use questionnaire using social platform is Google Form and research give the questionnaire through social media such as WhatsApp, Facebook, Instagram and more. This way is easier because of people nowadays use smartphone to communicate. This method is helpful and suitable by using simple random sampling.

## **Data Analysis**

The data in this study was analysed using the Statistical Package for Social Science (SPSS), version 28. SPSS is a piece of software that can utilise descriptive analysis and correlation to describe the relationship between independent and dependent variables. SPSS can convert data from Malaysian respondents into meaningful information. As a result, the researcher benefits, and the reliability analysis aids in data interpretation. There are three types of data analysis: reliability analysis, descriptive analysis, and Pearson's Correlation Coefficient.



## FINDINGS

### Demographic Analysis

Table 1: Respondents' Gender

		Frequency	Percent
Valid	Male	192	50.0
	Female	192	50.0
	Total	384	100.0

Table 2: Respondents' Age

		Frequency	Percent
Valid	18 - 25 year old	181	47.1
	25 - 30 year old	104	27.1
	30 - 45 year old	77	20.1
	45 year old and above	22	5.7
Total		384	100

Table 3: Respondents' Race

		Frequency	Percent
Valid	Malay	220	57.3
	Chinese	94	24.5
	India	64	16.7
	Other	6	1.6
	Total	384	100.0

Table 4: Respondents' Education Level

		Frequency	Percent
Valid	Primary School	3	0.8
	Secondary School	69	18.0
	Stpm / Diploma	139	36.2
	Bachelor Of Degree	161	41.9
	Masters	12	3.1

Table 5: Respondents' Occupation

		Frequency	Percent
Valid	Student	143	37.2
	Self-Employee	92	24.0
	Government Staff	89	23.2
	Private Staff	56	14.6
	Other	4	1.0
	Total	384	100.0

Table 6: Respondents' Income Level

		Frequency	Percent
Valid	No Income	134	34.9
	Below RM 1000	9	2.3
	RM 1000 - RM 3000	182	47.4
	RM 3000 - RM 5000	54	14.1
	RM 5000 and above	5	1.3
	Total	384	100.0

Table 7: Respondents' State

		Frequency	Percent
Valid	Kelantan	54	14.1
	Terengganu	27	7.0
	Pahang	37	9.6
	Johor	58	15.1
	Melaka	8	2.1
	Kuala Lumpur	24	6.3
	Selangor	31	8.1
	Negeri Sembilan	18	4.7
	Perak	30	7.8
	Kedah	26	6.8
	Perlis	21	5.5
	Pulau Pinang	11	2.9
	Sabah	19	4.9
	Sarawak	20	5.2
	Total	384	100.0

## Descriptive Analysis

### Service efficiency

Table 8: Descriptive Analysis of Service Efficiency

NO.	Item Description	N	Mean	Level Of Agreement
1.	Did you satisfied did with the speed and efficiency of the robot service you received?	384	3.90	Agree
2.	Did the efficiency of the robotic service at the restaurant impact your overall satisfaction with the dining experience?	384	3.62	Agree
3.	The robot service was efficient in meeting my needs.	384	3.88	Agree
4.	The robot service was easy to use and navigate.	384	3.98	Agree

5.	Did you satisfied with the accuracy of robotic service provided.	384	3.93	Agree
6.	Did robotic service function-able to you nicely?	384	3.99	Agree
7.	The robotic service responded quickly to my queries.	384	3.91	Agree
8.	I would use the robotic service again in the future.	384	3.99	Agree
9.	The robotic service met my expectations.	384	4.00	Agree
10.	Overall, I am satisfied with the efficiency of the robot service.	384	4.00	Agree
	Average Mean	384	3.92	Agree

## Time Saving

Table 9: Descriptive Analysis of Time Saving

NO.	Item Description	N	Mean	Level of Agreement
1.	The time-saving benefits of robotic service in a restaurant are more important to me than the novelty of using a robot.	384	3.97	Agree
2.	Did the robotic service save your time?	384	3.79	Agree
3.	Did the robotic service reduce your waiting time in the restaurant?	384	3.91	Agree
4.	Are you satisfied with the time it takes to receive your order when using robotic service in a restaurant?	384	3.91	Agree
5.	Did you satisfied with the time it took for your food to be prepared and served by the robotic system?	384	3.95	Agree
6.	Did the robotic service save your time compared to traditional service methods?	384	3.94	Agree
7.	The time-saving benefits of robotic service in a restaurant make me more satisfied with the value of the food and service.	384	3.89	Agree
8.	The speed of robotic service in a restaurant is more important to me than personalized service from a human server.	384	3.89	Agree
9.	I am willing to use a robot server for faster service than a human server in a restaurant.	384	3.92	Agree

10.	I believed that the speed and efficiency of robotic service in a restaurant enhances my overall dining.	384	3.98	Agree
	Average Mean	384	3.96	Agree

## Security

Table 10: Descriptive Analysis of Security

No.	Item Description	N	Mean	Level Of Agreement
1.	I believe the robotic service is reliable and trustworthy.	384	3.96	Agree
2.	I feel comfortable interacting with the robotic service.	384	3.74	Agree
3.	The robotic service provides clear instructions on how to use it safely.	384	3.97	Agree
4.	Did you satisfied with the security measures of the robotic service you have used.	384	3.99	Agree
5.	I am confident that the security measures in place for robotic services are effective.	384	4.02	Agree
6.	Did you satisfied the security measures in place for the robotic service in the restaurant.	384	4.00	Agree
7.	Are you satisfied with the level of training and knowledge displayed by the restaurant staff in regard to the robotic service.	384	3.92	Agree
8.	I trust the security measures implemented by the restaurant for the use of robotic service.	384	3.99	Agree
9.	I would recommend the restaurant's robotic service to others based on its security measures.	384	4.02	Agree
10.	The presence of security measures for robotic service in restaurant enhances my overall dining experience.	384	4.01	Agree
	Average Mean	384	3.96	Agree

## Monetary Value

Table 11: Descriptive Analysis of Monetary Value

No.	Item Description	N	Mean	Level of Agreement
1.	The cost of the robotic service in the restaurant was reasonable.	384	3.91	Agree
2.	I received good value for the price I paid for the robotic service.	384	3.75	Agree
3.	Have you ever felt that the cost of the robotic service in the restaurant was too high for the benefits it provides.	384	3.87	Agree
4.	Did you will recommend the restaurant to others based on its cost or value for money for the robotic service.	384	3.96	Agree
5.	Would you be willing to pay more for a restaurant that offers a wider range of robotic service options, such as automated ordering, robotic food delivery, and automated payment.	384	3.78	Agree
6.	Would you be more likely to visit a restaurant that offered a discount or promotion for the use of robotic service.	384	4.02	Agree
7.	Do you agree that the cost of the robotic service in the restaurant is fair compared to the cost of traditional human service.	384	3.93	Agree
8.	Did the cost of the robotic service affect your decision to dine at this restaurant.	384	3.97	Agree
9.	Did the price of the robotic service influence your decision to order more or less food or drinks than you would have otherwise.	384	3.91	Agree
10.	The cost of the robotic service did not negatively impact my overall satisfaction.	384	3.94	Agree
	Average Mean	384	3.90	Agree

## Customer Satisfaction

Table 12: Descriptive Analysis of Customer Satisfaction

No.	Item Description	N	Mean	Level of Agreement
1.	Robotic service in a restaurant improves the efficiency of my dining experience.	384	3.90	Agree
2.	Robotic service in a restaurant increases my overall satisfaction with my dining experience.	384	3.70	Agree
3.	I find robotic service in a restaurant to be impersonal.	384	3.83	Agree
4.	Overall, robotic service in a restaurant is more accurate than human service.	384	3.65	Agree
5.	I believe that a restaurant using robotic service cares less about its customers.	384	3.12	Neutral
6.	I believe that a restaurant using robotic service cares less about its customers.	384	3.72	Agree
7.	I feel comfortable interacting with a robot in a restaurant setting.	384	3.86	Agree
8.	Overall, robotic service in a restaurant increases the quality of my dining experience.	384	3.84	Agree
9.	I am willing to pay more for a restaurant that uses robotic service.	384	3.86	Agree
10.	The availability of robotic service in a restaurant increases my overall satisfaction with the dining experience.	384	3.90	Agree
	Average Mean	384	3.74	Agree

## Reliability Analysis

Table 13: Results for Reliability Analysis

Item Description	N.	No. of items	Cronbach's Alpha
Service Efficiency	384	10	0.810
Time Saving	384	10	0.795
Security	384	10	0.765
Monetary Value	384	10	0.752
Customers Satisfaction	384	10	0.779

## Pearson Correlation Analysis

Table 14: Relationship of factors that influence customers satisfaction towards robotic in restaurant

		CS	SE	TS	S	MV
CS	Pearson	1	.529**	.642**	.552**	.677**
	Correlation					
	Sig. (2-tailed)		.001	.001	.001	.001
	N	384	384	384	384	384
SE	Pearson	.529**	1	.788**	.746**	.682**
	Correlation					
	Sig. (2-tailed)	.001		.001	.001	.001
	N	384	384	384	384	384
TS	Pearson	.689**	.788**	1	.796**	.746**
	Correlation					
	Sig. (2-tailed)	.001	.001		.001	.001
	N	384	384	384	384	384
S	Pearson	.703**	.746**	.796**	1	.772**
	Correlation					
	Sig. (2-tailed)	.001	.001	.001		.001
	N	384	384	384	384	384



MV	Pearson	.677**	.682**	.762**	.772**	1
	Correlation					
	Sig. (2-tailed)	.001	.001	.001	.001	
	N	384	384	384	384	384

---

\*\* . Correlation is significant at the 0.01 level (2-tailed)

## DISCUSSION AND RECOMMENDATION

For demographic analysis:

The frequency and proportion of respondents' gender is shown above. A total of 384 responders are female 192, with a ratio of 50.0%. The total number of male responders is 192, representing a ratio of 50.0%. The highest age frequency 181 (47.1%) respondents with the age 18 – 25-year-old. The age with the lowest frequency is 45 years old and above with only 22 (5.7%) respondents. The highest frequency race 220 (57.3%) of the 384 responders is Malay. The lowest just 6 (1.6%) respondents for the last race, which is others. The education level of respondents, a total of 161 (41.9%) respondents has a Bachelor's degree as their greatest level of education. Primary School has the lowest frequency of respondents, with only three (0.8%). The highest frequency respondents' occupations with 143 (37.2%) responders are student. The lowest frequent occupation followed by others with 4 (1.0%) respondents. In income level of respondents most of respondents are not earning with a frequency of 134 (34.9%) respondents. The lowest frequency is followed by 5 (1.3) with an income level of RM5000 and above. The highest frequency and the corresponding percentage values for each state is Johor where 58 occurrences which make up 15.1% of the total. The lowest is Melaka, just appears 8 times, representing 2.1% of the total.

For descriptive analysis:

For service efficiency, the highest mean value is 4.00 which is for item “The robotic service met my expectations” and “Overall, I am satisfied with the efficiency of the robot service” refer to agree on level of agreement. The lowest mean is 3.62 refer to item “Did the efficiency of the robotic service at the restaurant impact your overall satisfaction with the dining experience?” also agree for level of agreement. For time saving, "I believed that the

speed and efficiency of robotic service in a restaurant enhances my overall dining." the highest mean in the range of means is 3.98, and their level of agreement is agreed. The lowest mean is 3.79 refer to item "Did the robotic service save your time?" with agree level of agreement. The highest range of mean for security is 4.02 which are for item "Are you the security measures in place for the robotic service in the restaurant" and "I would recommend the restaurant's robotic service to others based on its security measures". Both are agree in the level of agreement. The lowest mean is 3.74 for item "I feel comfortable interacting with the robotic service" and agree were mentioned. For monetary value, the highest mean is 4.02 with agree level of agreement for item "Would you be more likely to visit a restaurant that offered a discount or promotion for the use of robotic service" and the lowest mean is 3.75 with agree level of agreement for item "I received good value for the price I paid for the robotic service". The highest mean for customer satisfaction is 3.90 and agree level of agreement which have two item "Robotic service in a restaurant improves the efficiency of my dining experience" and "The availability of robotic service in a restaurant increases my overall satisfaction with the dining experience". The lowest mean is 3.12 and the level of agreement is neutral for this item "I believe that a restaurant using robotic service cares less about its customers".

For reliability analysis:

The first one is service efficiency; the variable had a total of 10 items under it with Cronbach's alpha value of 0.810 with the internal consistency of good ( $0.9 > \alpha \geq 0.8$ ). The last is monetary value, also with 10 items used as well under it and Cronbach's alpha value for this variable is 0.752. This value fall under the internal consistency of acceptable ( $0.8 > \alpha \geq 0.7$ ).

For Pearson Correlation Analysis:

The highest is the relationship between security and customer satisfaction toward robotic service in restaurant. The interpretation of the value 0.703 means that the relationship between those two variables is moderate positive correlation. The lowest is the relationship between service efficiency and customer satisfaction toward robotic service in restaurant. The interpretation of the value 0.592 means that the relationship between those two variables is moderate positive correlation.

Recommendations is the quantitative method is suited for this study because the goal is to determine the elements that influence customer satisfaction with robotic service restaurants in Malaysia. The second piece of recommendations is to choose respondents who are familiar with the questionnaire. This will facilitate data collection and increase the number of sample data. The last recommendation would be to increase the languages used for the questionnaire. The 2 languages were used for the questionnaire which were Bahasa Melayu and English. It would be more advantageous and beneficial if the questionnaire included languages such as Chinese and Tamil for wider and better understanding. This could potentially increase understandable languages in the questionnaire.

## **CONCLUSION**

Finally, the purpose of this study was to look at the elements that influence customer satisfaction with robotic service restaurants in Malaysia. Furthermore, other scholars undertaking study on robotic service restaurants in Malaysia may find this paper useful. The data obtained in Chapter 4 using the Statistical Package for the Social Sciences (SPSS) were investigated further, and conclusions were formed. As a result, it is reasonable to conclude that in Malaysian robotic service restaurants, there is a link between service efficiency, time savings, security, monetary value, and customer enjoyment. As a result, it is believed that all the information supplied throughout this research will assist parties involved in improving robotic service in restaurants comparable to industrialised countries.

## REFERENCES

- Akter, M., Sadekin, M. N., & Patwary, A. K. (2020). An Empirical Study on Students' Satisfaction from Mawlana Bhashani Science & Technology University, Bangladesh. *Review of Economics and Development Studies*, 6(2), 363-379.
- Al Mahmud, S. R. (2020). The effectiveness of Facebook advertisements on purchase intention of customers in Malaysia. *South Asian Journal of Social Sciences and Humanities*, 1(1), 97-104.
- Alom, S., Patwary, A. K., & Khan, M. M. H. (2019). Factors affecting the turnover intention of Bangladeshi migrants in the United Arab Emirates: An empirical study on the hotel industry. *International Journal of Innovation, Creativity and Change*, 8(3), 344-360.
- Amanina, O. L. E. H. F. (n.d.). Grab uji robot runner di singapura, Jimatkan Masa penghantar Makanan. SoyaCincau.com. Retrieved January 14, 2023, from [https://bm.soyacinciau.com/2021/05/21/grab-robot-runner-singapura-bantu-kumpul-pesanan-makanan/?utm\\_medium=Social&utm\\_source=Facebook#Echobox=1621579227](https://bm.soyacinciau.com/2021/05/21/grab-robot-runner-singapura-bantu-kumpul-pesanan-makanan/?utm_medium=Social&utm_source=Facebook#Echobox=1621579227)
- Amendinger, J., Becherer, D., & Schweizer, M. (2003). A monetary value for initial information in portfolio optimization. *Finance and Stochastics*, 7(1), 29-46.
- Fengmin, Z., Baijun, W., Jiangtao, B., Li, L., & Patwary, A. K. (2022). Investigating revisit intention of medical tourists in China through nutritional knowledge, perceived medical quality, and trust in the physiologist: A recommendation on health tourism policy measures. *Frontiers in Public Health*, 10, 893497.
- Hazbar, A. M. H., Alem Mohammed, A., & Karim, A. K. A. (2019). An Empirical Study of Factors Influencing hotel customers' online booking Intention. *مجلة العلوم التربوية و الدراسات الإنسانية*, (5), 1-17.
- Jang, S. M., Lee, K., Hong, Y.-J., Kim, J., & Kim, S. (2020). Economic evaluation of robot-based telemedicine consultation services. *Telemedicine and e-Health*, 26(9), 1134-1140
- Li, L., Ragavan, N. A., Patwary, A. K., & Baijun, W. (2022). Measuring patients' satisfaction toward health tourism in Malaysia through hospital environment, nutritional advice, and perceived value: A study on Chinese exchange students. *Frontiers in public health*, 10, 893439.
- Li, L., Wu, B., & Patwary, A. K. (2022). How marine tourism promote financial development in sustainable economy: new evidences from South Asia and implications to future tourism students. *Environmental Science and Pollution Research*, 29, 1155-1172.
- Li, L., Wu, B., & Patwary, A. K. (2022). The psychosocial factors affecting chinese Outbound Exchange and mobility students' academic performance during COVID-19. *Frontiers in psychology*, 13, 872516.
- Patwary, A. K., Roy, B., Hoque, R., & Khandakar, M. S. A. (2019). Process of developing a community based tourism and identifying its economic and social impacts: An Empirical study on Cox's Bazar, Bangladesh. *Pakistan Journal of Humanities and Social Sciences*, 7(1), 1-13.

Robot savings time. RobotWorx. (n.d.). Retrieved January 14, 2023, from <https://www.robots.com/articles/robot-savings-time>

Sumethokula, P., Patwary, A. K., Srinuanpanc, B., Srinuanpand, C., Suwandee, P., Thammathikul, A., & Phanong, W. (2020). The potential of new tour repackaging for creative tourism among entrepreneurs in Nakhon Si Thammarat. *International Journal of Innovation, Creativity and Change*, 13(10), 1752-1771.

Wu, B., Liu, S., Wang, J., Tahir, S., & Patwary, A. K. (2021). Assessing the mechanism of energy efficiency and energy poverty alleviation based on environmental regulation policy measures. *Environmental Science and Pollution Research*, 28, 40858-40870.

Wu, B., Zhai, B., Mu, H., Peng, X., Wang, C., & Patwary, A. K. (2021). Evaluating an economic application of renewable generated hydrogen: A way forward for green economic performance and policy measures. *Environmental Science and Pollution Research*, 1-15.

# THE VIRAL MARKETING ROLE IN DIRECTING CUSTOMER PURCHASING DECISION REGARDING FOOD IN TIKTOK

**Muhammad Fikri Akmal bin Mohd Anura, Muhammad Farez Nabil bin Abd Wahab,**

**Muhammad Harriz Erfan bin Zamani, Muhammad Faisal Arif bin Rosdi**

*Faculty of Hospitality, Tourism and Wellness, Universiti Malaysia Kelantan*

*Corresponding email: azimahothman@umk.edu.my*

---

## **ABSTRACT**

The advent of social media platforms has had a significant impact on consumer behavior, particularly in the realm of food purchasing choices. Among these platforms, TikTok has gained immense popularity as a platform for sharing short videos, including those related to food and dining experiences. This abstract delves into the influence of TikTok on customer purchase decisions specifically regarding food, and examines the underlying factors that shape these decisions. The research primarily aims to identify the factors that impact customers' purchase decisions in relation to food on TikTok. It specifically focuses on attractiveness, confidence, and incentives as the factors expected to play a role in shaping these decisions. The data for this study was collected using a structured questionnaire and subsequently analyzed using SPSS data analysis software.

**Keywords: The viral marketing role in directing customer purchasing decision regarding food in TikTok**

## **INTRODUCTION**

This chapter serves as an introduction to the research conducted on the impact of viral marketing on customer purchasing decisions specifically within the realm of TikTok food. It begins by providing background information, stating the problem that the research aims to address, presenting the research question and objective, defining the scope of the study, highlighting its

significance, and providing definitions of key terms. The chapter concludes by summarizing the content covered in Chapter 1.

Viral marketing is an innovative marketing strategy that leverages the power of internet users to spread messages and attract new customers. It involves the creation of messages that rapidly circulate within online communities, such as TikTok, in order to disseminate information and engage potential customers. Previous studies have indicated that several factors contribute to the success of viral marketing campaigns. These factors include the value of the product, its accessibility, the online distribution strategy employed, the characteristics of the viral marketing team, and the target audience. Additionally, trust, dependability, the desire to share content, and the attractiveness of the viral message are all crucial elements. For instance, Wei (2014) discovered a positive correlation between consumer incentives and attitudes toward viral marketing, and consumer attitudes toward viral marketing significantly influence their intention to make a purchase. Furthermore, Francis and Alexander (2015) established a positive causal relationship between consumers' propensity to rely on wireless marketing techniques and the social aspects of viral marketing.

By conducting research in this area, the aim is to shed light on the impact of viral marketing on customer purchasing decisions in the context of TikTok food. The chapter provides an overview of the relevant background information, outlines the problem statement, presents the research question and objective, specifies the scope of the study, emphasizes its significance, and provides definitions of key terms. Finally, it summarizes the content covered in Chapter 1.

There are three objectives of this research:

1. To determine the attractiveness of the direction customer purchasing decisions food in TikTok.
2. To determine the confident of the direction customer purchasing decisions food in TikTok.
3. To determine the incentive of the direction customer purchasing decisions food in TikTok.

## **Significance of the Study**

### **Academic Aspects**

Academic exposure to online food platforms like TikTok can increase public awareness and drive the online food market. This study benefits entrepreneurs, helps entrepreneurs market their products, and directs customer purchasing decisions regarding food on TikTok.

### **Practical Aspects**

This study aims to improve TikTok's marketing strategy for entrepreneurs to enhance their products and attract consumers to purchase food online. By understanding the increasing number of customers, entrepreneurs can promote their products and ensure they go viral on social media. Promotions should be welcomed by customers to attract more customers.

## **LITERATURE REVIEW**

### **PURCHASE DECISION**

The process of making a purchase decision is a critical step in the consumer buying journey. It involves carefully assessing various options and considering factors such as price, quality, features, brand reputation, and personal preferences. This decision-making process can be influenced by marketing messages, recommendations, online reviews, and past experiences. Nobel laureate Herbert A. Simon argued that economic decision-making is a complex process, influenced not only by rational considerations but also by emotions and non-rational factors. He suggested that the assumption of perfect rationality should be replaced with a more realistic framework that accounts for the cognitive limitations of individuals. Cognitive effort and decision-making time also come into play as factors affecting the decision-making process.

The amount of time and effort invested in each stage of the decision-making process depends on the perceived risk and motivations of the consumer. In instances of impulse purchases, consumers may spend minimal time on information search and evaluation, resulting in spontaneous buying decisions. This study aims to examine the factors that influence customer purchasing decisions, with a particular focus on attractiveness, confidence, and incentives.



## **ATTRACTIVENESS**

Viral message content on TikTok is a powerful public marketing strategy that influences buyers' choices by delivering humour and uplifting messages. Creative product marketing videos that catch viewers' attention and make them want to buy products are also effective. Videos with specific themes, viral music, and trademarks can make them stand out from the competition. Continuous promotion of products through TikTok, such as discounts and freebies, increases sales and attracts buyers, even if they initially don't intend to buy.

## **CONFIDENCE**

Confidence is a belief in one's abilities, qualities, and judgments, characterized by self-assurance and confidence in one's abilities and abilities. It is a state of confidence that stems from a deep sense of self-worth and self-belief. Building and maintaining confidence can vary from person to person and is influenced by factors like past experiences, achievements, support systems, mind set, and personal growth.

Developing confidence involves setting goals, embracing failure as learning opportunities, recognizing strengths and weaknesses, and engaging in self-care and self-reflection. Confidence is crucial for personal and professional success, empowering individuals to express themselves, pursue opportunities, and reach their full potential. It is also beneficial for businesses, as it helps customers trust and engage with products, especially through viral marketing on social media platforms like TikTok.

## **INCENTIVE**

An incentive is a motivating factor that encourages specific behaviour or action. It can take various forms, such as monetary rewards, discounts, bonuses, gifts, recognition, or privileges. Incentives are used in various contexts, such as business, economics, psychology, education, and marketing, to create a perceived value for individuals. They can encourage productivity, increase sales, boost performance, foster loyalty, promote behaviour change, or achieve specific goals. Effective incentives are tailored to the target audience, perceived as valuable and attainable, and the timing and delivery of incentives play a crucial role in their effectiveness.

## Research Hypothesis

In this study, there were four hypotheses that have been indicated to study the research objectives as following:

H1: Increase the rate of exposure to the buyer's decision related to food product.

H2: Consumer choice for food products is influenced by how attractive the message is to influence the buyer's decision.

H3: Incentives used to determine the buyer's decision about food products have an effect on consumers buying these products.

H4: Consumers' decision to buy food products is influenced by their confidence in the facts that go viral in this industry.

## Research Framework

To completing the analysis, a conceptual framework will be used to gathering the data in research. This framework describes the relationship between independent variable and dependent variable.

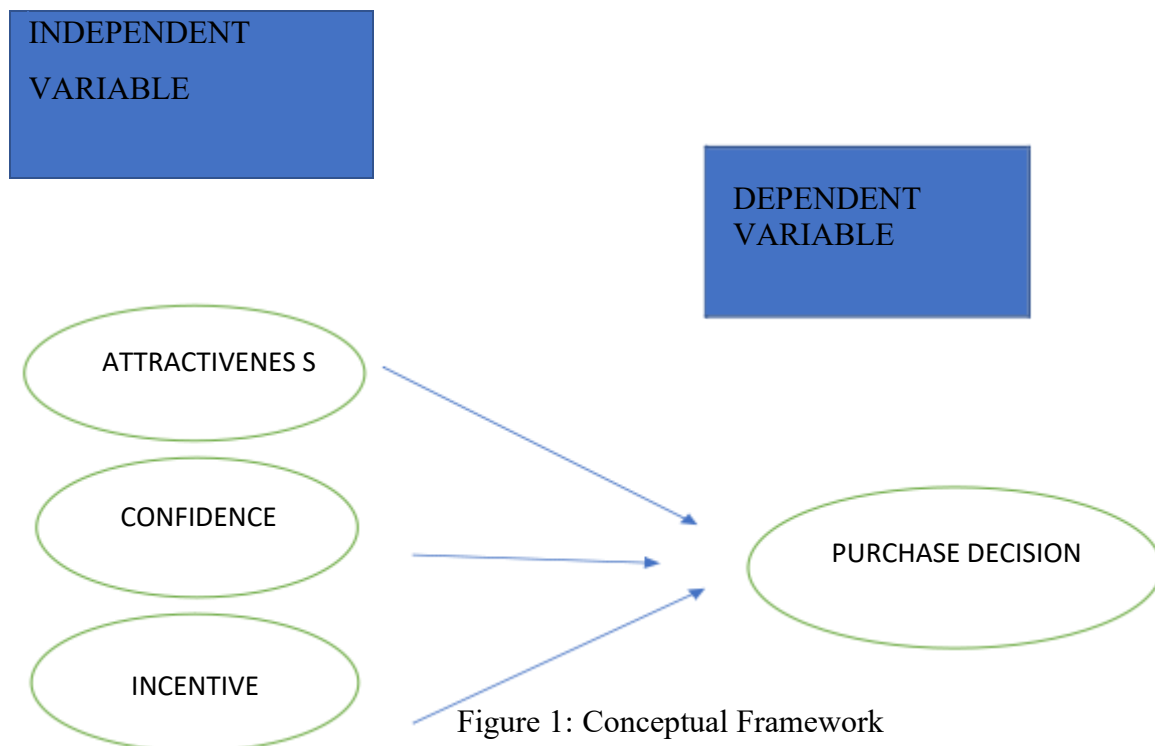

Figure 1: Conceptual Framework

## **METHODOLOGY**

### **Research Design**

A research design is a strategy for answering research questions using empirical data. A well-planned design ensures methods align with objectives and appropriate data analysis. Research designs can be divided into quantitative, qualitative, and mixed method research. In this study, a quantitative research method will be used, which is the most selective and selective approach. This method measures and collects data from various sources, using statistical and mathematical tools to determine results.

Quantitative research designs are fixed and deductive, with variables and hypotheses clearly defined in advance. This study uses both quantitative methods and questionnaires, allowing for easy dissemination through an online platform.

### **Data Collection**

The data collection procedure is a systematic process for gathering, recording, and acquiring data for research, analysis, or informational purposes. It involves planning, designing instruments, selecting methods, collecting data, and ensuring quality. Data collection is divided into primary and secondary methods, with primary data collected through interviews, surveys, questionnaires, and experiments. This study uses data to induce up to data-supported objectives and topics.

Using social media platforms like Instagram, Telegram, and What, researchers use Google Forms to collect information efficiently and cost-effectively. The form is divided into three sections: Part A, Part B, and Part C. Part A questions respondents about demographic segmentation, while Part B discusses dependent variables and the stage of purchase decisions. Part C discusses the independent variables of attractiveness, confidence, and incentive, which influence customer purchasing decisions on TikTok.

## **Sampling**

This study uses probability sampling techniques, including simple random sampling, systematic sampling, stratified sampling, and cluster sampling, to ensure the population resembles the research. Simple random sampling is the most fundamental method, as it ensures equal probability of being selected from a sampling frame for customer purchasing decisions on TikTok food. The questionnaire includes essential questions and demographics, allowing respondents to easily answer and collect data.

## **Data Analysis**

Data analysis involves inspecting, cleansing, transforming, and modelling data to discover useful information, inform conclusions, and support decision-making. It involves drawing inductive inferences and distinguishing signals from noise. Analytical data is crucial for researchers to understand the study, particularly in directing customer purchasing decisions on TikTok.

## **FINDINGS**

### **DEMOGRAPHICS ANALYSIS**

GENDER					
		Frequency	Percent	Valid Percent	Cumulative Percent
Valid	Female	169	55.8	55.8	55.8
	Male	134	44.2	44.2	100.0
	Total	303	100.0	100.0	

The table presented the gender distribution of the participants. Out of the total of 303 respondents, 134 were male and 169 were female. This means that men accounted for 44.2% of the respondents, while women constituted the remaining 55.8%.

AGE					
		Frequency	Percent	Valid Percent	Cumulative Percent
Valid	18-20	42	13.9	13.9	13.9
	21-23	193	63.7	63.7	77.6
	24-26	33	10.9	10.9	88.4
	27-29	12	4.0	4.0	92.4
	30 and above	23	7.6	7.6	100.0
	Total	303	100.0	100.0	

The table displayed the distribution of respondents based on their age. The respondents were categorized into different age ranges: 18-20 (42 respondents), 21-23 (193 respondents), 24- 26 (33 respondents), 27-29 (12 respondents), and 30 and above (23 respondents). The largest percentage of respondents fell within the 21-23 age range, accounting for 63.7% of the total respondents. Following that, 13.9% of respondents were in the 18-20 age range, 10.9% were in the 24-26 age range, 7.6% were in the 30 and above age range, and the smallest percentage, 4%, consisted of respondents aged 27-29.

RACE					
		Frequency	Percent	Valid Percent	Cumulative Percent
Valid	Chinese	38	12.5	12.5	12.5
	Indian	29	9.6	9.6	22.1
	Malay	216	71.3	71.3	93.4
	Other	20	6.6	6.6	100.0
	Total	303	100.0	100.0	

The table provided an overview of the respondents' racial distribution. A total of 303 individuals participated in the survey, representing different races. Among them, there were 38

Chinese respondents, 29 Indian respondents, 216 Malay respondents, and 21 respondents from other racial backgrounds. The largest proportion of respondents belonged to the Malay race, comprising 71.3% of the total. Following that, the Chinese respondents accounted for 12.5%, the Indian respondents made up 9.6%, and the lowest percentage of respondents came from other racial backgrounds, amounting to 6.6%.

LEVEL OF EDUCATION					
		Frequency	Percent	Valid Percent	Cumulative Percent
Valid	DEGREE	224	73.9	73.9	73.9
	DIPLOMA	12	4.0	4.0	77.9
	MASTER	3	1.0	1.0	78.9
	SPM	34	11.2	11.2	90.1
	STPM	30	9.9	9.9	100.0
	Total	303	100.0	100.0	

The table presented data on the distribution of respondents based on their level of education. A total of 303 individuals participated in the survey, with varying educational backgrounds. Out of these respondents, 224 held a degree, 12 had a diploma, 3 had a master's degree, 34 had completed SPM (Sijil Pelajaran Malaysia), and 30 had completed STPM (Sijil Tinggi Pelajaran Malaysia).

The highest percentage of respondents, accounting for 73.9% of the total, had a degree. Following that, 11.2% of the respondents had completed SPM, 9.9% had completed STPM, 4% had a diploma, and the lowest percentage, 1%, had a master's degree.

MONTHLY INCOME					
		Frequency	Percent	Valid Percent	Cumulative Percent
Valid	BELOW RM 1000	246	81.2	81.2	81.2
	RM 1000-RM 2999	45	14.9	14.9	96.0
	RM 3000-RM 4999	12	4.0	4.0	100.0
	Total	303	100.0	100.0	

The table provided an overview of the respondents' monthly income distribution. Among the participants in the survey, the data revealed that 246 individuals had a monthly income below RM1000. Additionally, 45 respondents reported a monthly income between RM1000 and RM2999, while 12 respondents fell within the income range of RM3000 to RM4999.

The highest percentage, representing 81.2% of the total respondents, had a monthly income below RM1000. The next highest percentage, 14.9%, belonged to those with a monthly income between RM1000 and RM2999. The lowest percentage, at 4%, consisted of respondents with a monthly income within the range of RM3000 to RM4999.

**DESCRIPTIVE ANALYSIS**

Descriptive Statistics					
	N	Minimum	Maximum	Mean	Std. Deviation
Attractiveness	303	1.43	5.00	4.8581	.35224
Confidence	303	1.00	5.00	4.8432	.37826
Incentive	303	1.00	5.00	4.8375	.39839
Purchase Decision	303	1.00	5.00	3.8713	.74135
Valid N (listwise)	303				

The table displays the data regarding the number of respondents, mean rankings, and standard



deviations for both the independent and dependent variables. Among the independent variables, attractiveness had the highest mean ranking at 4.8581, closely followed by confidence at 4.8432, and incentive at 4.8375. On the other hand, the dependent variable, purchase decision, had a mean ranking of 3.8713..

## REABILITY ANALYSIS

<b>Variable</b>	<b>Number of item</b>	<b>Cronbach's coefficient</b>	<b>Alpha Strength of Association</b>
<b>Attractiveness</b>	7	0.932	<b>Very strong</b>
<b>Confidence</b>	8	0.943	<b>Very Strong</b>
<b>Incentive</b>	8	0.950	<b>Very Strong</b>
<b>Purchase decision</b>	5	0.841	<b>Strong</b>

To assess the attractiveness variable's impact on purchase decisions related to food on TikTok, a set of seven questions was utilized. The Cronbach's Alpha coefficient for this section's questions yielded a result of 0.932, indicating a very strong level of internal consistency. Similarly, for the confidence and incentive variables, a set of eight questions was employed. The Cronbach's Alpha coefficients for these questions were found to be 0.943 and 0.950, respectively, signifying a very strong level of internal consistency as well.

In the measurement of purchase decisions concerning food on TikTok, five questions were used. The Cronbach's Alpha coefficient for this section's questions was 0.841, indicating a strong level of internal consistency. This suggests that the coefficient obtained for these questions in measuring purchase decisions regarding food on TikTok is also reliable.

## PEARSON CORRELATION

		Correlation	
		Attractiveness	Purchase Decision
Attractiveness	Pearson correlation	1	.948**
	Sig. (2-tailed)		.000
	N	303	303
Purchase Decision	Pearson Correlation	.948**	1
	Sig (2-Tailed)	.000	
	N	303	303

H1: There is a significant relationship between confidence and purchase decision regarding food in TikTok

The table shows relationship between attractiveness and purchase decision regarding food in TikTok . The p-value of this variable shows 0.948, which means that it is very strong. It also indicates that there is a positive and significant relationship between both variables. Therefore, the hypothesis is accepted since there is a significant relationship between attractiveness and purchase decision regarding food in TikTok.

**Correlation**

		Confidence	Purchase Decision
Confidence	Pearson correlation	1	.956**
	Sig. (2-tailed)		.000
	N	303	303
Purchase Decision	Pearson correlation	.956**	1
	Sig. (2-tailed)	.000	
	N.	303	303

H2: There is a significant relationship between confidence and purchase decision regarding food in TikTok

The table depicts the relationship between confidence and purchase decision regarding food in TikTok. The p-value of this variable shows 0.956, which means that it is very strong. It also illustrates that there is a positive and significant relationship between the variables. Thus, the hypothesis is accepted since there is a significant relationship between confidence and purchase decision regarding food in TikTok.

**Correlation**

		Incentive	Purchase Decision
Incentive	Pearson correlation.	1	.967**
	Sig. (2-tailed)		.000
	N	303	303
Purchase Decision.	Pearson correlation	.967**	1
	Sig. (2-tailed)	.000	
	N	303	303

H3: There is a significant relationship between incentive and purchase decision regarding food in TikTok

The table shows the relationship between the incentive and purchase decision regarding food in TikTok. The p-value of this variable shows 0.967, which means that it is very strong. It illustrates that there is a positive and significant relationship between the variables. Therefore, the hypothesis (H3) is accepted since there is a significant relationship between incentive and purchase decision regarding food in TikTok.

## **DISCUSSION & RECOMMENDATION**

Attractiveness is important to customer purchasing decisions regarding food in TikTok based on the study hypothesis. the p-value is 0.000, which is smaller than the 0.01 significance level. While the correlation coefficient between attractiveness and purchasing decisions shows 0.948, there is a

moderate positive and significant relationship between the variables. Therefore, hypothesis (H1) is accepted. It can be shown that the results of the literature review can be trusted with the results of this study.

Next, confidence is also significant to customer purchasing decisions regarding food in TikTok based on the study hypothesis. the p-value is 0.000, which is smaller than the 0.01 significance level. While the correlation coefficient between confidence and purchasing decisions shows 0.956, there is a positive and significant relationship between the variables. Therefore, hypothesis (H1) is accepted. It can be shown that the results of the literature review can be trusted with the results of this study.

Lastly, incentive is also significant to customer purchasing decisions regarding food in TikTok based on the study hypothesis. the p-value is 0.000, which is smaller than the 0.01 significance level. While the correlation coefficient between incentive and purchasing decisions shows 0.967, there is a positive and significant relationship between the variables. Therefore, hypothesis (H1) is accepted. It can be shown that the results of the literature review can be trusted with the results of this study.

There are a number of restrictions to take into account when conducting research on "The Viral Marketing Role in Directing Customer Purchasing Decision Regarding Food in TikTok." First off, there may be a gender imbalance in the results due to the male respondents' lesser sample size (134) compared to the female respondents' larger sample size (169). This disparity might have an impact on how well the findings apply to the wider population. Second, the findings' application to other age demographics may be constrained by the substantial concentration of respondents (64%) in the 21-to-23 age range. Furthermore, the distribution of respondents by race is unbalanced, with a higher percentage of Malay respondents (71%) compared to other races, which could affect how broadly the research findings can be applied to various ethnic groupings.

it's critical to overcome the gender gap in the responder sample. Compared to male respondents, there were more female respondents in the survey. To provide a thorough knowledge of

the relationship between viral marketing and customer purchasing decisions in the context of TikTok, future study should try to attain a more equal representation of genders.

## CONCLUSION

Overall, the research highlighted the significant role of viral marketing in shaping customer purchasing decisions regarding food on TikTok. The findings provide valuable insights for businesses and content creators to effectively engage TikTok users and influence their purchasing decisions in the context of food marketing. Individual tastes and personal preferences continued to play a significant role in the decision-making process because various consumers had varying preferences for particular foods or flavours. Additionally, it has been discovered that providing viewers with incentives like discounts, coupons, and promotional offers will encourage them to try or buy the advertised food items.

## REFERENCES

- Abedniya, A. and Mahmoudi, S. S. (2010). "The impact of social networking websites to facilitate the effectiveness of viral marketing", *International Journal of Advanced Computer Science and Applications*, 1(6): 139-146.
- Aghdaie, S. F.; Sanayei, A. and Etebari, M. (2012). "Evaluation of the Consumers' Trust Effect on Viral Marketing Acceptance Based on the Technology Acceptance Model". *International Journal of Marketing Studies*, 4(6): 79-94.
- Akter, M., Sadekin, M. N., & Patwary, A. K. (2020). An Empirical Study on Students' Satisfaction from Mawlana Bhashani Science & Technology University, Bangladesh. *Review of Economics and Development Studies*, 6(2), 363-379.
- Alom, S., Patwary, A. K., & Khan, M. M. H. (2019). Factors affecting the turnover intention of Bangladeshi migrants in the United Arab Emirates: An empirical study on the hotel industry. *International Journal of Innovation, Creativity and Change*, 8(3), 344-360.
- An examination of the factors affecting consumer's purchase decision in the Malaysian retail market | Emerald Insight.* (2018, February 13). <https://www.emerald.com/insight/content/doi/10.1108/PRR-08-2017-0034/full/html>
- Bartlett, J. E.; Kotrlik, J. W. and Higgins, C. C. (2001). "Organizational Research: Determining Appropriate Sample Size in Survey Research". *Information Technology, Learning, and Performance Journal*, 19(1): 43-50.
- Battley, A. (n.d.). How To Be More Confident In Your Own Decisions. [www.linkedin.com. https://www.linkedin.com/pulse/how-more-confident-your-own-decisions-aaron-battley](https://www.linkedin.com/pulse/how-more-confident-your-own-decisions-aaron-battley)
- Borges, B. (2009). "Marketing 2.0 Bridging the Gap Between Seller and Buyer Through Social Media Marketing", *Wheatmark*.

- Chen, T. (2022, June 8). *The Impact of Online Reviews on Consumers' Purchasing Decisions: Evidence From an Eye-Tracking Study*. *Frontiers*.  
<https://www.frontiersin.org/articles/10.3389/fpsyg.2022.865702/full>
- Edwards, I. (2023). Customer incentives: 6 reasons to use them. *BeeLiked*.  
<https://www.beeliked.com/blog/customer-loyalty/customer-incentives-6-reasons-to-use-them>
- Fengmin, Z., Baijun, W., Jiangtao, B., Li, L., & Patwary, A. K. (2022). Investigating revisit intention of medical tourists in China through nutritional knowledge, perceived medical quality, and trust in the physiologist: A recommendation on health tourism policy measures. *Frontiers in Public Health*, 10, 893497.
- Figure 1: Definition of fine-grained video attractiveness prediction. . . (n.d.). *ResearchGate*.  
[https://www.researchgate.net/figure/Definition-of-fine-grained-video-attractiveness-prediction-The-view-counts-video\\_fig1\\_324218512](https://www.researchgate.net/figure/Definition-of-fine-grained-video-attractiveness-prediction-The-view-counts-video_fig1_324218512)
- Gale, C. (2023). Incentive marketing for revenue growth. *Revenue Marketing Alliance*.  
<https://www.revenuemarketingalliance.com/incentive-marketing/#>
- Hazbar, A. M. H., Alem Mohammed, A., & Karim, A. K. A. (2019). An Empirical Study of Factors Influencing hotel customers' online booking Intention. *مجلة العلوم التربوية و الدراسات الإنسانية*, (5), 1-17.
- House, G. (2021). 5 Tips to Help You Make Decisions With Confidence. *The Guest House*.  
<https://www.theguesthouseocala.com/5-tips-to-help-you-make-decisions-with-confidence/>
- Indeed Editorial Team. (2022). The Importance of Confident Decision-Making in the Workplace. *Indeed.com*.  
<https://www.indeed.com/career-advice/career-development/confident-decision-making#:~:text=Each%20time%20you%20practice%20confident,You'll%20have%20fewer%20mistakes.>
- Li, L., Ragavan, N. A., Patwary, A. K., & Baijun, W. (2022). Measuring patients' satisfaction toward health tourism in Malaysia through hospital environment, nutritional advice, and perceived value: A study on Chinese exchange students. *Frontiers in public health*, 10, 893439.
- Li, L., Wu, B., & Patwary, A. K. (2022). How marine tourism promote financial development in sustainable economy: new evidences from South Asia and implications to future tourism students. *Environmental Science and Pollution Research*, 29, 1155-1172.
- Li, L., Wu, B., & Patwary, A. K. (2022). The psychosocial factors affecting chinese Outbound Exchange and mobility students' academic performance during COVID-19. *Frontiers in psychology*, 13, 872516.
- Mitchell, S. (2022, November 18). Why are incentives important? 4 ways incentives benefit your business. *Tillo*.  
[https://www.tillo.io/blog/why-are-incentives-important?hs\\_amp=true](https://www.tillo.io/blog/why-are-incentives-important?hs_amp=true)
- Patwary, A. K., Roy, B., Hoque, R., & Khandakar, M. S. A. (2019). Process of developing a community based tourism and identifying its economic and social impacts: An Empirical study on Cox's Bazar, Bangladesh. *Pakistan Journal of Humanities and Social Sciences*, 7(1), 1-13.
- ProThesisWriter.com. (n.d.). How to Organize Limitations of a Research Study.  
<https://prothesiswriter.com/blog/limitations-in-research>
- Research Guides: Organizing Your Social Sciences Research Paper: Limitations of the Study. (n.d.).  
<https://libguides.usc.edu/writingguide/limitations#:~:text=Definition,the%20findings%20from%20your%20research.>

- Research Limitations. (n.d.). Research-Methodology. <https://research-methodology.net/research-methods/research-limitations/>
- Rybackowska, M., Sparks, L., & Sułkowski, U. (2020). Consumers' purchase decisions and employer image. *Journal of Retailing and Consumer Services*, 55, 102123. <https://doi.org/10.1016/j.jretconser.2020.102123>
- Southern, M. G. (2022, February 14). TikTok A Key Part Of Consumers' Path To Purchase. Search Engine Journal. <https://www.searchenginejournal.com/tiktok-a-key-part-of-consumers-path-to-purchase/437912/>
- Sumethokula, P., Patwary, A. K., Srinuanpanc, B., Srinuanpand, C., Suwandee, P., Thammathikul, A., & Phanong, W. (2020). The potential of new tour repackaging for creative tourism among entrepreneurs in Nakhon Si Thammarat. *International Journal of Innovation, Creativity and Change*, 13(10), 1752-1771.
- What is Purchase Decision | IGI Global.* (n.d.). <https://www.igi-global.com/dictionary/a-neuromarketing-perspective-for-assessing-the-role-and-impact-of-typefaces-on-consumer-purchase-decision/86606>
- Willman-Iivarinen, H. (2017, December 15). *The future of consumer decision making - European Journal of Futures Research.* SpringerOpen. <https://eujournalfuturesresearch.springeropen.com/articles/10.1007/s40309-017-0125-5>
- Wu, B., Liu, S., Wang, J., Tahir, S., & Patwary, A. K. (2021). Assessing the mechanism of energy efficiency and energy poverty alleviation based on environmental regulation policy measures. *Environmental Science and Pollution Research*, 28, 40858-40870.
- Wu, B., Zhai, B., Mu, H., Peng, X., Wang, C., & Patwary, A. K. (2021). Evaluating an economic application of renewable generated hydrogen: A way forward for green economic performance and policy measures. *Environmental Science and Pollution Research*, 1-15.



# FACTORS INFLUENCING THE USAGE OF ONLINE FOOD DELIVERY SERVICE AMONG UNIVERSITY STUDENT IN MALAYSIA

MUHAMMAD MAHZUZ BIN MALIM, MUHAMMAD NAUFAL SULHI BIN ABDUL  
SUKOR, MUHAMMAD NURHAFIZ BIN HERMAN, MUHAMMAD ZAHIRUDDIN BIN  
AZMAN & MAZNE BINTI IBRAHIM

*Faculty of Hospitality, Tourism and Wellness, Universiti Malaysia Kelantan  
Corresponding email: mazne@umk.edu.my*

---

## ABSTRACT

Intention of usage of online delivery services has emerged as one of the most significant issues affecting student's behavior today since it necessitates a high level of engagement between contact personnel and specific clients and is largely dependent on meeting intangible requirements. Additionally, the degree of client satisfaction with a company's services may directly correlate with the degree to which workers are content with the responsibilities that have been given to them. This research intends to determine the indicator of intention of usage of online delivery services in student's daily life by using factor which is time saving orientation, convenience and peer influence. This study employed quantitative method which is using questionnaire surveys which were distributed to all university students in Malaysia. Based on the questionnaire distributed, a total of 384 respondents had been obtained and the data gathered had been analyzed for descriptive, reliability and correlation by using Statistical Package for the Social Sciences (SPSS) version 26. The discussion is due to the outcome of a survey in public institutions of higher learning (IPTA) in Malaysia.

**Keyword:** *Intention of usage, online, food delivery services, public institutions, higher learning institutions (IPTA)*

---

## INTRODUCTION

Online food delivery service is actually a combination of the online platform nowadays in meals and drinks sector. Online food delivery service is one of the classifications from e-commerce that uses the method of online to offline business that means the consumers ordered their product of food or drinks through the online platform and earn the product physically. According to Purvis, Mao and Robinson (2019), they said that the rise of the online service methods had change the world of the food industry in the aspect of the communication of the customers and the food suppliers. This factors could make the food industry sustain such as

economic, social, and also environmental. Also, the market of the e-commerce has experienced rapid growth because of a number of facets that impact customers to implement e-commerce tools. As a precedent, the factor that plays the role is the work style of the consumer that consumes a lot of time, the increase of the number of the retailers that use the online platform and the awareness of the e-commerce application by the consumers nowadays.

Food delivering service started in 1995 in northern California by the company World Wide Water also known as Waiter.com. According to Dosas and Samosas (2017), this service expanded to several additional cities in the United States quickly after their first launching in that year. By the late 2000s, many pizza chains had created the same mechanism in order of the increase of smartphone usage among people. In 2015, the service grew to its highest level when online ordering began taking phone orders, and today online ordering has started to become the norm.

According to Pang (2017), in Malaysia, online food delivery service started in 2012 with the Food panda's platform, followed by Grab in 2018 and so on. The food delivery businesses now have an easier time connecting with customers and promoting themselves, notably through social media platforms like Facebook, Instagram, and Twitter, which is in accordance with Malaysia's booming e-commerce sector. In this context, people can choose whether they want their restaurant to be mentioned on one of the many independent websites that offer restaurant reviews.

There are three objectives of this research:

- To identify factors influencing the university student to use online food delivery service:
  - I. To identify the relationship between time saving orientation and the usage of online food delivery service.
  - II. To identify the relationship between convenience and the usage of online food delivery service.
  - III. To identify the relationship between peer influence and the usage of online food delivery service.

## **SIGNIFICANCE OF THE STUDY**

### **Food Delivery Service Company**

From the food delivery service company point of view, this research can provide a significant benefit which is the key factor of why university students are mostly using their online service every day. By conducting this study, the potential companies can use this opportunity to grow their business and may offer some deals to make sure their service offered every day for the society and especially to the students.

### **University Student**

Students can gain the benefits from this study especially the students that are using the online food delivery service. With this study, the university student can identify the main factors of why they are using this service and know the benefit of it. The students also will have an awareness about the facilities of the service provided.

### **Future Researcher**

From this survey, the future researchers can refer to this study as a guide to do better research and advance what the researcher have done for this research. With all the points and explanations, the future researcher can use it as a reference and expand the knowledge on the area of study regarding on online food delivery service.

## **LITERATURE REVIEW**

### **The Usage of Online Food Delivery Service**

The most popular reason given by Chai and Yat (2019) for the apparent demand for quick meals during or after a long workday is the use of online food delivery services. A variety of readily available food delivery services save consumers from the stress of having to consider about meals, beverages and snacks. Additionally, ordering food online can save time over going to the restaurant. Online meal delivery services are quietly but steadily transforming the food and beverage industry due to a number of factors, including the potential for business expansion, increased employee efficiency, order accuracy, and the creation of enormous client databases (Moriarty, 2016).

Fast food is typically served ready to be consumed and has expanded to constitute a considerable proportion of overall nutritional intake (Burgoine et al., 2019; Mackenbach et al.,

2019). A different ordering method that appears to be gaining popularity is using third-party online ordering and delivery services, or online meal delivery companies (Maimaiti et al., 2018). Online platforms are used by customers to make orders, which are then sent to restaurants where the food is prepared and delivered to customers by couriers employed by the restaurant or the online food delivery service (Yeo et al., 2017). However, the majority of the food cooked for online food delivery services is done so at already-existing food outlet facilities (Allen et al., 2020).

### **Time Saving Orientation**

When using online FDI, clients' wants and needs vary. In context of technology adoption, some studies found out that significant relationship among disposition and behavioral intention to use online services (Ingham, 2017; Chang, Yan & Tseng, 2015). Particularly, as it addresses in efficient analysis, consumers often to have "purchase time" during they purchase on the internet (Jensen, 2012; Settle, 2002). The need to save time is an immensely significant dimension on buyers' proclivity to use technology based on self-service (Meuter et al., 2003). Most consumers desire to minimize their time commitments so that they can complete other vital responsibilities promptly.

People occasionally explore themselves in short time based on routine consist of duty and amusement, forcing them to seek solutions to circumvent time (Bashir et al., 2015; Settle & Alreck, 1991). A lot of people detest the exertion necessary to get meals also need to queue in eateries since of the contemporary hectic style of life. They ought to anticipate nourishment to be handed over swiftly (Yeo et al., 2017) through the most essential elements that affects individual's behaviour in purchasing any item on internet (Khalil, 2004).

Internet shopping is supposed to conserve time because clients not required physically forsake their homes to finalize a deal. As stated by Sultan and Uddin's (2011), time savings have a positive impact on behavior demand for online purchasing. According to the study, a substantial percentage of respondents said that internet shopping because they did not have to squander hours like offline shopping while travel (which they should literally arrive at the store). Alreck and Settle (2002) emphasized that physical buyer longer than online shopping since they do not have to stand throughout the line. Based on Alreck (2009) observed that numerous clients wished they can save more time in different research. Time savings have a highly beneficial impact on behaviour intention to embrace online purchasing (Ganapathi, 2015; Zendehdel et al., 2015).

## **Convenience**

By utilizing goods and services or making purchases, reduced non-monetary transaction expenses are regarded as being more convenient, including time, energy and money (Chang & Polonsky, 2012). Hours of operation, location, and phone, internet, or in-person accessibility all affect how convenient something is (Meuter, Ostrom, Roundtree & Bitner, 2000; Seiders, Berry & Gresham, 2000). Additionally, the most significant factor and benefits of convenience in internet business services are exploring and possessing comfort (Hanus, 2016). When people need to make an order, it is the most convenient since it saves them time from having to travel to the location (Verhoef & Langerak, 2001).

Consumer convenience will be concluded because it will impact customer loyalty (Dhurup, 2006). Consumers are bound to get inspired to use the composition on a regular basis once it meets their convenience expectations. Users can employ the new, simple, and secure electronic technologies, in line with the current trends (Kimes, 2011). Due to the flexibility of placing orders and receiving delivery at any time, many prefer ordering food online versus doing it in-person. Making takeout orders online offers various benefits, including preventing inadequate client service and reducing in-store traffic (Chen & Hung, 2015; Katawetawarakas & Wang, 2011).

Both time and diligence convenience are important factors in influencing consumer adoption of OFD services (Collier & Kimes, 2013). Customers that prioritize convenience would constantly invest taking time and diligence into account (Zhou et al., 2007). They desire to purchase at home to conserve time. Food delivery services are considerably safer and more convenient for customers since they have the ability to place an order anywhere and anytime. The distribution platform will be designed to work with any mobile device, including smartphones and tablets.

## **Peer Influence**

Peer influence is established as occasions where only a person has an impact on or is impacted by one or more persons at their age. Consumers adapt in reactions to their close companions and colleagues, which is a prevalent concept in influence definitions. People can evolve as a result of peer pressure, for better or worse. Peer influence is a meaningless concept that can relate to any kind of change (Laursen & Veenstra, 2021). Thus, peer influence can be viewed as an instance in which one person inspires or is influenced by others in their own circle. A recurring theme in definitions of influence is change people adjust to their acquaintances and associates. Peer pressure has the power to either improve or damage individuals. Any kind of

transformation might be referred to as peer influence, which is a general understanding. Society pressure and socialization, which describe (respectively) peer impact is different from adaptive and maladaptive change in this sense (Laursen, 2018).

Peer pressure implies coercion or persuasion, as opposed to socialization is an expression with positive connotations that is meant to be the passing of knowledge and abilities. Influence encompasses both concepts but is not the same as either. Influence presumes a shift in direction. The study discovered that peers can play a more important effect in meal choice than calorie labels. By virtue of peer pressure, FDA use has a significant impact on friends' social interactions (Li, Miroso & Bremer, 2020). The characteristics of the connection or group dictate the direction of change as it aim. Peer influence almost often amplifies similarities between friends and associates. Despite the likelihood of complimentary (Kindermann & Gest, 2018), there is no significant prove that peer interaction while adolescence supports divergent roles and/or strengthens distinctions. In fact, youth join groups of people who are similar to them and make friendships this is known as selection similarity.

## **Research Hypothesis**

From this study, the variables such as Time saving orientation, Convenience and Peer Influence was determined as independent variables, while the Usage of Online Food Delivery as dependent variable. Based on the variable cited above, these hypotheses are created:

### **HYPOTHESIS 1:**

- H0: There is no relationship between time saving orientation and the usage of online food delivery service among university students.
- H1: There is a relationship between time saving orientation and the usage of online food delivery service among university students.

### **HYPOTHESIS 2:**

- H0: There is no relationship between convenience and the usage of online food delivery service among university students.
- H1: There is a relationship between convenience and the usage of online food delivery service among university students.

### **HYPOTHESIS 3:**

- H0: There is no relationship between peer influence and the usage of online food delivery service among university students.

- H1: There is a relationship between peer influence and the usage of online food delivery service among university students.

## Research Framework

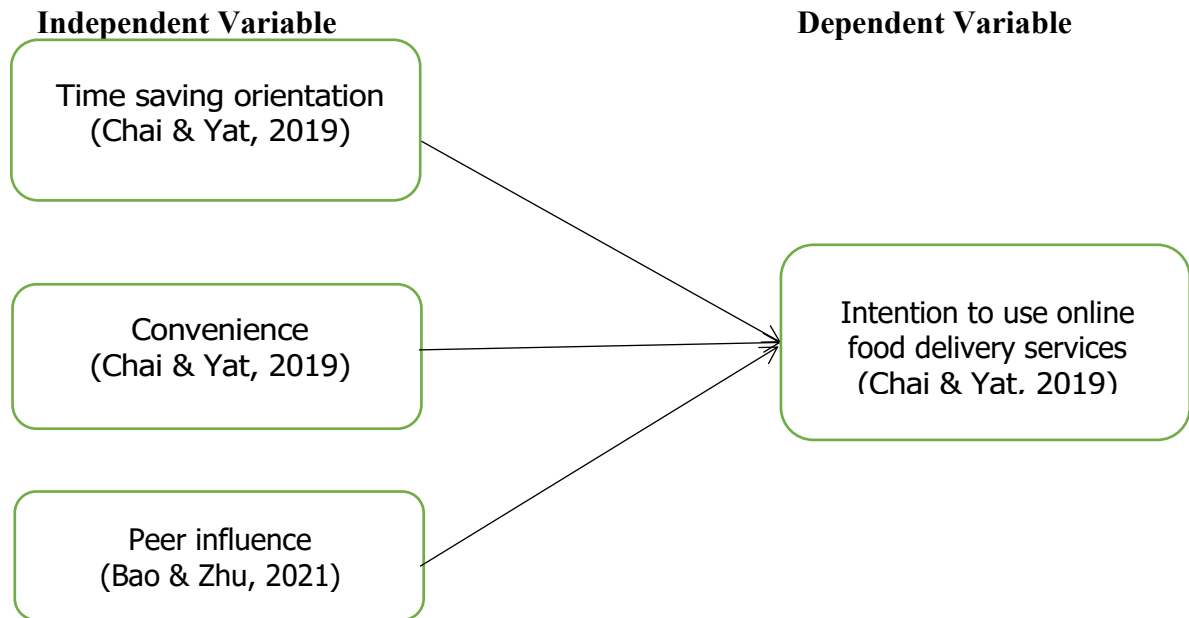

Figure 1: Conceptual Framework

## METHODOLOGY

### Research Design

A specific study design will be carried out by the researchers using a strategy and framework called research design. A quantitative research approach will be applied in this study's research design (Torchim, 2015). In addition, the quantitative methodology is the most appropriate for carrying out this study. As a result, this strategy uses mathematical and statistical method to determine results. This quantitative technique can be created through a questionnaire survey or in-person interviews, according to Oxford Fajar (2013). This study employed quantitative techniques and questions in order to distribute its large-scale research survey through an internet platform.

### Sampling Method

The sampling method is an approach that aids researchers in learning more about a population from a sample of their findings by concentrating on a single individual. Instead, the

researcher will choose sample by using probability random sampling from a whole sampling frame of all eligible people. It is a sampling strategy in which the researcher chooses population members depending on their evaluation (Saunders, 2019). Simple random sampling is a non-probability sampling strategy. The main goal of the data collection phase is to distribute the questionnaires created during the pilot phase to a sample of university students who were representative of those who used online food delivery services.

### **Sample Size**

The concept "sample size" refers to the small portion of the population that has been chosen for a given study. To obtain information on the group, the researcher chooses and contacts a representative group of people or components that fall inside the target demographic. Based on the results, the researcher groups the characteristics of the population into features they wanted. The word "sample survey" refers to the practice of surveying to collect data from a sample.

The sample size for this study will be stated on the percentage of Malaysian university students who used online food delivery services. This study's population of 1,000,000 users of university students will be focused on (Hennink, Kaiser & Weber, 2019). The study will decide on the sample size by using the formula from Krejcie and Morgan (1970). According to chart in Table 1, 1,000,000 people used the online food delivery services which are among university students. This study therefore includes the largest sample, 384 respondents. Finally, 384 surveys had been distributed to respondents to get their opinions.

### **Research Instrument**

Research instrument is a device to measure and analyze data for a research. This study used several past questionnaires in order to create a sound and solid research instrument. In this questionnaire, there are several section. Section A is a survey question that asks about the demographic profile. It asks about the details of the demographic for example gender, race, religion, age range and educational attainment.

Next is Section B. In this section the questions asked are related to the dependent variable that is the usage of online food delivery services. This dependent variable is being measured by these survey questions and the outcome will be evaluated using a five-point Likert scale. 1 denoting "strongly disagree", 2 denoting "disagree", 3 denoting "not at all", 4 denoting "agree", and 5 denoting "strongly agree".



Then, Section C represented the independent variables that consisted of time saving orientation, convenience and peer influence. To ascertain the link between all those independent variables and online food delivery services, the researchers used studios, a tool created by Daffodil International University and used by other scholars. These questionnaires employ a five-point Likert scale with 1 denoting "strongly disagree", 2 denoting "disagree", 3 denoting "not at all", 4 denoting "agree" and 5 denoting "strongly agree" to measure the first independent variable.

Each of the dependent variable and independent variables in this study are related and had been measured by using the 5 point Likert scale of “1 = Strongly disagree”, “2 = Disagree”, “3 = Not at all”, “4 = Agree” and “5 = Strongly agree”.

### **Data Collection Method**

This method is used to generate the data received into a numerical form and is being used because the scale of the research is large. This study technique was chosen by the researcher for a number of reasons, including its affordability, and ease of use. The researcher had distributed the questionnaire to the targeted respondent by using Google Form. The researcher utilized the online platform to collect all the data.

### **Data Analysis**

Analysis of data is the process of evaluating data by carefully examining each component of the information presented. Information from different sources are collected, inspected, and broken. Next, the researcher used descriptive statistics, reliability statistics and Pearson's correlation to evaluate the quantitative data. The data had been analyzed by using the Statistical Package for the Social Sciences (SPSS) version 26.

## **FINDINGS**

### **Descriptive Analysis**

According to Kenton (2019), a descriptive statistic is a details that summarizes certain data set, that signify a population or sample. In descriptive statistics, measurements of central tendency and measures of variability (expansion) are separated. Measurement unit such as mean, median, and mode are used, while to measure variability it used standard deviation and variance.

## Reliability Test

The reliability experiment use non-biased (error-free) and to ensure the accuracy of calculation in different part of instrument (Kumar, 2013). Measurements are accurate to the degree that they produce clear outcomes. Reliability is a critical contribution to validity, but it is not an adequate term of rationality. The relationship between reliability and validity can be demonstrated by a basic example of a weighing instrument. If the apparatus calculates erratically from time to time, it is not correct and cannot be accurate. The reliability calculation is the way instrument being calculated in achieving accurate measurement. Total of values is close to the value (Cronbach, 1951).

Table 1.0: Score of Reliability Test

Variable	Number of items	Reliability Cronbach's Alpha	Comment
<b>Online Food Delivery</b>	5	0.746	Excellent
<b>Time Saving</b>	5	0.796	Excellent
<b>Convenience</b>	5	0.836	Excellent
<b>Peer Influence</b>	5	0.823	Excellent

Table 1.0 of the SPSS findings highlighted the importance of both independent and dependent variables in this investigation. The Cronbach Alpha results for all variables are Online Food Delivery (0.746). Time saving (0.796), Convenience (0.836) and Peer Influence (0.823).

## Demographic Profile

The online platform had assigned a total of 353 questionnaire sets. In this portion, respondents' contextual profiles were presented. This section is on the respondent's demographic profile and background: gender, race, religion, age, and educational background. According to Table 1.1, 61.8% (n=218) of respondents are female and 38.2% (n=135) are male. According to the table, the majority of the race's respondents are Malay, with 199 (56%) followed by Chinese, with 60 (17%). Also, 48 respondents (14%) are Indian, while 46 (13%) are from other races.

According to the data, the majority of religion among those who responded is Islam,

which has a frequency of 225 respondents (63.7%), followed by Christian, which has a frequency of 50 respondents and a percentage of (14.2%). Furthermore, Buddhism had 49 respondents (13.9%), followed by other religions with 29 respondents (8.2%).

Based on Table 1.1, the respondents to this survey are mostly between the ages of 21 and 30, with a total of 261 (74%). This is followed by respondents under the age of 20 years old, with 58 (16%). While the age group 31-40 years old had 23 replies (7%) and the age group 41-50 years old had three respondents (1%). The age group over 51 years old has the fewest respondents (8%).

Finally, Table 1.1 demonstrates that the majority of respondents (73.7%, n=260) had a degree. This was followed by 73 respondents (20.7%) receiving a diploma. While 16 of the respondents (4.5%) have a Master's degree. Last but not least, four respondents (1.1%) have a PhD.

Table 1.1: Respondent Demographic Profile – Gender

<b>Category</b>	<b>Respondent's Profile</b>	<b>Frequency N= 353</b>	<b>Percentage (%)</b>
Gender	Male	135	38.2%
	Female	218	61.8%
Race	Malay	199	56%
	Chinese	60	17%
	Indian	48	14%
	Others	46	13%
Religion	Islam	225	63.7%
	Christian	50	14.2%
	Buddhism	49	13.9%
	Others	29	8.2%
Age Group	Less than 20 years old	58	16%
	21-30 years old	261	74%
	31-40 years old	23	7%
	41-50 years old	3	1%
	51 years old and above	8	2%

Education	Diploma	73	20.7%
Level	Degree	260	73.7%
	Master	16	4.5%
	PHD	4	1.1%

## Hypothesis Testing

In this part, three (3) possibilities were provided. The first hypothesis establishes a favorable association between university students' time-saving orientation and their use of online meal delivery services. The second hypothesis investigates the association between convenience and university students use online food delivery services. The third hypothesis looks into the relationship between peer influence and university students use of online meal delivery services.

Table 1.2: Summary result of Spearman Correlation Coefficient.

Hypothesis	Result	Findings of Data Analysis
<b>H1:</b> There is a relationship between time saving orientation and the usage of online food delivery service among university students.	$r = 0.622, p = 0.000$	<b>H1: Accepted</b>
<b>H2:</b> There is a relationship between convenience and the usage of online food delivery service among university students.	$r = 0.677, p = 0.000$	<b>H2: Accepted</b>
<b>H3:</b> There is a relationship between peer influence and the usage of online food delivery service among university students.	$r = 0.600, p = 0.000$	<b>H3: Accepted</b>

The table above summarize the findings of this research. Following are some of the hypotheses that have been tested for this study:

Hypothesis 1 (H1) proposed that time saving have relationship with the usage of online food delivery service among university students. The finding shows in table where it stated the

value of Spearman Correlation Coefficient, which is  $r = 0.662$ ,  $p = 0.000$ . Thus, the result accepts hypothesis 1 (H1), whereby time saving is positively significant with the usage of online food delivery service among university students.

Furthermore, Hypothesis 2 (H2) proposed that convenience have relationship with the usage of online food delivery service among university students. The finding reported in Table 1.2 revealed that the recorded value of Spearman Correlation Coefficient, which is  $r = 0.677$ ,  $p = 0.000$ . Thus, the result accepts hypothesis 2 (H2) whereby convenience is positively significant with the usage of online food delivery service among university students.

Lastly, Hypothesis 3 (H3) anticipated that peer influence has a relationship with the usage of online food delivery service among university students. According to the finding stated in Table 1.2, the findings demonstrated that the value recorded in Spearman Correlation Coefficient,  $r = 0.600$ ,  $p = 0.000$ . Thus, the result accepts hypothesis 3 (H3), whereby peer influence is positively significant with the usage of online food delivery service among university students.

## **DISCUSSION AND RECOMMENDATION**

The initial goal of this research is to investigate the variables impacting the use of online food delivery services. It can be concluded that there is a considerable correlation among university students' preference for time savings and their use of online food delivery services. Encouragement for using an online food delivery service is provided by the first independent variable. The effect of the correlation between the independent and dependent variables stated that hypothesis H1 is reflected. The majority of respondents agreed that the person delivering meals should not be very busy because this may cause a delay in delivery.

Next, objective is focuses on identifying the connection among convenience and the usage of online food delivery service. The results show that convenience positively relates to the usage of online food delivery services. The result of the relationship between the independent and dependent variables reveals the H2's reflection. The majority of responders concurred that they are certain that timely deliveries of meals will win them over and keep them using the online food delivery service. They also agreed that their expectation that online food delivery services would cover a large area will increase their purpose to use online food delivery services. The respondents acknowledge that relationship between convenience and the usage of online food delivery service among university students.

The third goal of the research is to discover the relationship between peer influence and the usage of online food delivery services. Based on the data analysis, both peer influence and

the usage of online food delivery services have beneficial relationship. It displays how H3 captures that there is a positive relationship between peer influence and the usage of online food delivery services.

Some empirical elements have been identified and can have a bearing on university students in Malaysia's use of online food delivery services. For the sake of progress, the research for further studies, certain recommendations were made. The researchers might do additional research into the variables affecting university students' usage of online food delivery services. This is a crucial topic of research because it can provide light on how university students' behaviours are evolving and how they are adjusting to the digital world.

The current study has identified several factors influencing university students' usage of online food delivery services, such as time saving orientation, convenience and peer influence. However, there are likely to be other factors that have not been identified in this study. For instance, the impact of social media on the usage of online food delivery services could be further explored. Additionally, the impact of cultural and regional differences on the usage of online food delivery services could be investigated.

Furthermore, the current research has focused on university students in one country. It seems to be intriguing in extend the research to other nations to see if the same factors influence the usage of online food delivery services. Additionally, the study could be extended to other age groups to see if the same factors influence the usage of online food delivery services among them.

In a nutshell, it is thought that additional investigation into the variables affecting university students' usage of online food delivery services is necessary. Such studies might offer insightful information about how university students are changing their behaviour and adjusting to the digital era.

## **CONCLUSION**

This study examines the factors influencing the usage of online food delivery services among university students. It looks at the motivations and preferences of university students when it comes to online meal ordering, as well as the variables that affect their choice to use online food delivery services. The research looks at the effects as well of time saving orientation, convenience and peer influence on the usage of online food delivery services. Finally, the study looks at the potential implications of the usage of online food delivery services for university students. The results of the study suggest that time saving orientation, convenience and peer

influence are the main factors influencing the usage of online food delivery services among university students.

The entire goal of this study has been accomplished, in summary of the reliable knowledge. Nearly all of the respondents stated that they intended to use an online food delivery service as the outcome of experiences, which were mostly influenced by time saving orientation, convenience and peer influence. When they used the internet for food delivery services, they delighted and loved it.

This study's sample size is rather small because the researcher simply used a Google Form to collect responses from Malaysian public university students. An accurate message could be delivered quickly to a large number of the intended audience by a Malaysian public university student. In order to get over this problem, a future study in this area needs to increase the sample size, conduct a more thorough analysis of the factors impacting university students' usage of online meal delivery services, and produce a more accurate study conclusion.

Considering the previous chapter's recommendations, several empiric factors have been established that decide there are likely to be other factors that have not been identified in this study. For instance, more research may be done on the impact of social media on the usage of online food delivery services. Additionally, it may be studied how cultural and regional variations affect people's usage of online food delivery services.

Latest research has also concentrated on university students in a single nation. If the same characteristics affect the usage of online meal delivery services, it would be fascinating to expand the study to other nations. The study might also be expanded to other age groups to see if the same criteria apply to how often other ages use online meal delivery services.

## REFERENCES

- Akter, M., Sadekin, M. N., & Patwary, A. K. (2020). An Empirical Study on Students' Satisfaction from Mawlana Bhashani Science & Technology University, Bangladesh. *Review of Economics and Development Studies*, 6(2), 363-379.
- Alom, S., Patwary, A. K., & Khan, M. M. H. (2019). Factors affecting the turnover intention of Bangladeshi migrants in the United Arab Emirates: An empirical study on the hotel industry. *International Journal of Innovation, Creativity and Change*, 8(3), 344-360.
- Alreck, P. L., DiBartolo, G. R., Diriker, M., Dover, H. F., Passyn, K. A., & Settle, R. B. (2009). Time pressure, time saving and online shopping: exploring a contradiction. *Journal of Applied Business Research*, 25(5), 85.
- Alreck, P. L., & Settle, R. B. (2002). The hurried consumer: Time-saving perceptions of Internet and catalogue shopping, *Journal of Database Marketing & Customer Strategy Management*, 10(1), 25-35.
- Chang Y. W., Polonsky M. J. (2012). The influence of multiple types of service convenience on behavioral intentions: the mediating role of consumer satisfaction in Taiwanese leisure setting. *International Journal of Hospitality Management*. 31: 107-118.

- Chen, N., & Hung, Y. (2015). Online shopping orientation and purchase behavior for high-touch products, *International Journal of Electronic Commerce Studies*, 6(2), 187-202.
- Collier, J. E., & Kimes, S. E. (2013). Only if it is convenient: Understanding how convenience influences self-service technology evaluation, *The Scholarly Commons*. Retrieved from <http://scholarship.sha.cornell.edu/articles>
- Fengmin, Z., Baijun, W., Jiangtao, B., Li, L., & Patwary, A. K. (2022). Investigating revisit intention of medical tourists in China through nutritional knowledge, perceived medical quality, and trust in the physiologist: A recommendation on health tourism policy measures. *Frontiers in Public Health*, 10, 893497.
- Ganapathi, R. (2015). A study on factors affecting online shopping behavior of consumers in Chennai, *Journal of Management Research and Analysis*, 2(2), 123-126.
- Hazbar, A. M. H., Alem Mohammed, A., & Karim, A. K. A. (2019). An Empirical Study of Factors Influencing hotel customers' online booking Intention. *مجلة العلوم التربوية و الدراسات الإنسانية*, (5), 1-17.
- Katawetawaraks, C. & Wang, C. L. (2011). Online shopper behavior: influences of online shopping decision, *Asian Journal of Business Research*, 1(2), 66-74.
- Kimes, S. E. (2011). Customer perceptions of electronic food ordering, *Cornell Hospitality Report*, 11(10), 6-15.
- Laursen, B. & Veenstra, R. (2021). Toward understanding the functions of peer influence: A summary and synthesis of recent empirical research. *Journal of Research on Adolescence*, 31(4), 889-907. doi:10.1111/jora.12606
- Li, L., Ragavan, N. A., Patwary, A. K., & Baijun, W. (2022). Measuring patients' satisfaction toward health tourism in Malaysia through hospital environment, nutritional advice, and perceived value: A study on Chinese exchange students. *Frontiers in public health*, 10, 893439.
- Li, L., Wu, B., & Patwary, A. K. (2022). How marine tourism promote financial development in sustainable economy: new evidences from South Asia and implications to future tourism students. *Environmental Science and Pollution Research*, 29, 1155-1172.
- Li, L., Wu, B., & Patwary, A. K. (2022). The psychosocial factors affecting chinese Outbound Exchange and mobility students' academic performance during COVID-19. *Frontiers in psychology*, 13, 872516.
- Meuter, M. L., Ostrom, A. L., Bitner, M. J. & Roundtree, R. (2003). The influence of technology anxiety on consumer use and experiences with self-service technologies, *Journal of Business Research*, 56(11), 899-906.
- Pang, V. (2017). We Visited foodpanda Malaysia. Conclusion? We NEVER Want To Run A Food Delivery Startup.
- Patwary, A. K., Roy, B., Hoque, R., & Khandakar, M. S. A. (2019). Process of developing a community based tourism and identifying its economic and social impacts: An Empirical study on Cox's Bazar, Bangladesh. *Pakistan Journal of Humanities and Social Sciences*, 7(1), 1-13.



- Seiders, K., Voss, G. B., Grewal, D. & Godfrey, A. L. (2005). Do satisfied customers buy more? Examining moderating influences in a retailing context, *Journal of marketing*, 69(4), 26-43.
- Sumethokula, P., Patwary, A. K., Srinuanpanc, B., Srinuanpand, C., Suwandee, P., Thammathikulf, A., & Phanong, W. (2020). The potential of new tour repackaging for creative tourism among entrepreneurs in Nakhon Si Thammarat. *International Journal of Innovation, Creativity and Change*, 13(10), 1752-1771.
- Verhoef, P. & Langerak, F. (2001). Possible determinants of consumers' adoption of electronic grocery shopping in the Netherlands. *Journal of Retailing and Consumer Services*, 8, 275-285.
- Wu, B., Liu, S., Wang, J., Tahir, S., & Patwary, A. K. (2021). Assessing the mechanism of energy efficiency and energy poverty alleviation based on environmental regulation policy measures. *Environmental Science and Pollution Research*, 28, 40858-40870.
- Wu, B., Zhai, B., Mu, H., Peng, X., Wang, C., & Patwary, A. K. (2021). Evaluating an economic application of renewable generated hydrogen: A way forward for green economic performance and policy measures. *Environmental Science and Pollution Research*, 1-15.
- Yeo, V. C. S., Goh, S. K. & Rezaei, S. (2017). Consumer experiences, attitude and behavioral intention toward online food delivery (OFD) services, *Journal of Retailing and Consumer Services*, 35, 150-162.
- Zendehtdel, M., Paim, L. H. & Osman, S. B. (2015). Students' online purchasing behavior in Malaysia: understanding online shopping attitude, *Cogent Business & Management*, 2(1), 1-13.
- Zhou, L., Dai, L. W. & Zhang, D. S. (2007). Online shopping acceptance model- a critical survey of consumer factors in online shopping, *Journal of Electronic Commerce Research*, 8(1), 41-62

# MEASURING PERCEIVED SERVICE QUALITY TOWARD CUSTOMERS LOYALTY IN MALAYSIA FAST FOOD RESTAURANT

*MUHAMMAD ZAIMUDDIN BIN ZUNAI, MUHAMMAD ZA'IM BIN MOHD ASRI,  
NASIHAN BINTI MOHD RODZI, NATASHA BINTI ISMAIL & MAZNE BINTI IBRAHIM*

*Faculty of Hospitality, Tourism and Wellness, Universiti Malaysia Kelantan  
Corresponding email: mazne@umk.edu.my*

---

## ABSTRACT

This study examines the relationship between service quality, fast food restaurant, tangibility, reliability, assurance, empathy and responsiveness which is the main factor that plays an important role in ensuring customer loyalty towards fast food restaurants among Malaysians. We are using quantitative methods which is using questionnaire surveys were distributed to all layers of Malaysians regardless of race and age. Based on the questionnaire provided, we obtained a total of 384 respondents and the data gathered and analyzed for descriptive, reliability and correlation using SPSS version 26. In this study, the reliability test is one option to discuss the pilot test which is to know that the question is valid for the variables. Next, the Pearson correlation identifies the relationship between tangibility, reliability, assurance, empathy, responsiveness and customer loyalty in Malaysia's fast-food restaurants.

**Keywords: Service Quality, Fast Food Restaurant, Tangibility, Reliability, Assurance, Empathy, Responsiveness**

---

## INTRODUCTION

Fast food restaurant is a type of restaurant that serves food and drinks that are ready to be served quickly. Fast food generally has a standardized preparation and cooking process, so it can be served quickly to customers. Fast food outlets, sometimes referred to as quick service restaurants (QSR) in the business. This restaurant has certain features in its business which are specialising in fast meal fare and providing scant table service. Fast food companies typically serve cuisine that is "sweet meat diet" friendly and has an affordable menu.

Fast food restaurants are typically a part of a chain of eateries or franchise businesses that supply each restaurant with standardised ingredients or partially produced food and supplies via a controlled supply system. There are many fast food restaurant companies today such as KFC, Mc Donald, Subway and others. Those fast food companies are the largest and most numerous in the world. Every country in the world, including Malaysia, has its franchise and restaurants are multinational corporations.

**There are objectives of this research:**

This research is aiming to accomplish the following objectives:

1. To identify the attribute of service quality in influencing customers to visit fast food restaurants.
  - a. To identify the relationship between tangibility and customer loyalty towards fast food restaurants in Malaysia.
  - b. To identify the relationship between reliability and customer loyalty towards fast food restaurants in Malaysia.
  - c. To identify the relationship between assurance and customer loyalty towards fast food restaurants in Malaysia.
  - d. To identify the relationship between empathy and customer loyalty towards fast food restaurants in Malaysia.
  - e. To identify the relationship between responsiveness and customer loyalty towards fast food restaurants in Malaysia.

## **SIGNIFICANCE OF THE STUDY**

### **Researchers**

This study explores the importance of the service quality toward fast food restaurants surrounding Malaysia people. This part uses five dimensions which are tangibility, reliability, assurance, empathy and responsiveness to take out the perceived service quality of fast food. Researchers use a lot of material like media social, and technology to investigate customer satisfaction which will lead to customer loyalty.

### **Owners**

This study will provide information about the customer's loyalty in fast food restaurants in Malaysia. The study clarified the problems that fast food restaurants faced. Fast food restaurants are one of the main choices where a million people use to get some food. Indeed, fast food restaurants have numerous advantages and disadvantages for everyone. Therefore, fast food restaurant operators can use the information obtained from this study to ensure customer loyalty towards their restaurant.

## **LITERATURE REVIEW**

In order to present a balanced perspective that contains conflicting evidence, discrepancies, established and latest thinking, a literature review must be an insightful, unique, and yet objective summary of the data (Catherine L Winchester, 2016). The systematic literature research goes beyond a quick evaluation of literature and requires more than just a few succinct bullet points. It is an extension of the information gathering that may be done to obtain a personal viewpoint into the history of a topic. Performing a literature review is essential for coming up with research ideas, incorporating what is known about a subject, finding potential knowledge gaps, and determining how the study could contribute to a deeper understanding of the subject (Mark Salji, 2016).

### **Service Quality**

Measure of how well a company meets consumer expectations in terms of the services it provides. In comparison to their consumer's expectations, customers purchase services. The level of service in fast food restaurants can vary depending on a multitude of variables, such as the restaurant chain, the location, the management style, and specific staff members. In fast

food restaurants, there are some common elements that contribute to the overall service quality. One of the key elements in determining an organization's performance and greater efficiency is customer happiness in general. The SERVPERF instrument's definition of customer satisfaction is used in this essay. (Cronin and Taylor, 1992)

### **Fast Food Restaurant**

An industry term for a specific kind of the term "quick-service restaurant" (QSR) refers to a restaurant that sells fast food and provides minimal table service. These places often offer a set menu and limited table service, which encourages guests to place their orders, pay, and get their food quickly. The fast food restaurant business is growing rapidly in this decade. Example for fast food restaurants is McDonald's, KFC, Pizza hut, and Subway.

### **Tangibility**

What is meant by "tangibility" is the outward look of physical facilities, including the equipment, personnel, and written materials offered by the service provider. (Blose & Tankersley, 2004). For instance, the appearance of the staff and the hygiene of fast food restaurants. Tangibility is a term frequently used in business and marketing to refer to a product or service's tangible qualities that buyers can actually experience.

### **Reliability**

In a fast food restaurant, reliability refers to the business's dependable and constant performance in providing its goods and services. It includes a number of crucial components that provide a dependable client experience. The way a service provider responds to a customer's issue and provides the appropriate service as requested and at the scheduled time are all factors in reliability (Blose & Tankersley, 2004). For example, customers will believe what they see in the advertisement and they will accept that they can get the same as the advertisement.

## **Assurance**

Described as the extent to which service providers are knowledgeable, courteous, and able to engender confidence. Restaurant customers feel secure when transacting in money there since the staff members are kind, informed, and welcoming. Additionally, the assurance dimension comprises the following: customers feel secure in their transactions; employees regularly show consideration for customers; and staff are knowledgeable enough to respond to customers' inquiries (Parasuraman et al., 1988).

## **Empathy**

Empathy is the staff members' tenderness and love for the client (Zeithaml et al., 1990). Empathy is important because the staff needs to understand the customer's thoughts and emotions. In addition, by filling in knowledge gaps, empathy enables businesses to engage with their customers more effectively.

## **Responsiveness**

Refers to how quickly and attentively a business responds to customer requirements, requests, and concerns. Responsiveness is depending on how ready the service provider or its staff is to satisfy the expectations of their customers (Saghier & Nathan, 2013). It entails taking the initiative to deliver effective and beneficial customer service. Customer satisfaction and referrals are both positively correlated with responsiveness.

## **Research Hypothesis**

A hypothesis ought to be reasonable, testable, and take into consideration the most recent findings and research techniques. A forecast or a hypothesis is also a statement of the relationship between two variables. It suggests that an independent variable and a dependent variable are causally related. As a result, the research suggests:

H1o: There is no relationship between tangibility and customer loyalty towards fast food restaurants in Malaysia.

H1a: There is a relationship between tangibility and customer loyalty towards fast food restaurants in Malaysia.

H2o: There is no relationship between reliability and customer loyalty towards fast food restaurants in Malaysia.

H2a: There is a relationship between reliability and customer loyalty towards fast food restaurants in Malaysia.

H3o: There is no relationship between assurance and customer loyalty towards fast food restaurants in Malaysia.

H3a: There is a relationship between assurance and customer loyalty towards fast food restaurants in Malaysia.

H4o: There is no relationship between empathy and customer loyalty towards fast food restaurants in Malaysia.

H4a: There is a relationship between empathy and customer loyalty towards fast food restaurants in Malaysia.

H5o: There is no relationship between responsiveness and customer loyalty towards fast food restaurants in Malaysia.

H5a: There is a relationship between responsiveness and customer loyalty towards fast food restaurants in Malaysia.

### **Research Framework**

Figure 1 shows the conceptual framework about measuring perceived the service quality toward customer loyalty in Malaysia fast food restaurants. The dependent variable for this research is customer loyalty in Malaysia fast food restaurants, and this is 5 dimensions of independent variable in service quality that conclude which are tangibility, reliability, assurance, empathy and responsiveness.

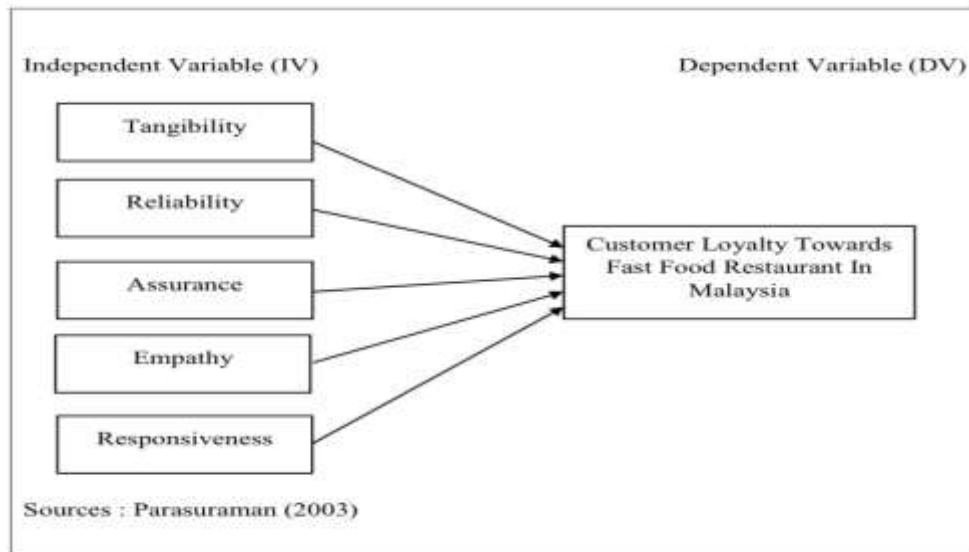

Figure 1 : Conceptual Framework



## **METHODOLOGY**

### **Research Design**

In this study, the researcher used a quantitative research method. In addition, the quantitative approach is the most appropriate research method to conduct this research. This method is an organized way to measure and gather data from different sources. While this method also has statistics and mathematical tools to determine the results. In addition, quantitative can be determined by the relationship between the cause of the issue and the factors affected by the issue. Based on Oxford Fajar (2013), this quantitative method can be developed through questionnaires or face-to-face interviews. In this study, the researcher will make more use of online platforms to conduct questionnaires and quantitative methods because they can be disseminated on a large scale.

### **Data Collection**

The researcher used the main data approach for this investigation. Data that has never been seen or that has never existed before is referred to as primary data. Primary data is the outcome of the initial investigation. Primarily, primary data collection and analysis take more time. Primary data collection techniques come in two flavours: quantitative and qualitative. The researcher then used a questionnaire to gather data. This is due to the researcher's employment of a quantitative research methodology. Additionally, because they are standardised, surveys are less expensive than other approaches and simpler to manage. Data concerning numerical variables make up quantitative data, used to verify or put to the test theories and premises. A subject's generalizable facts can be established using this research technique. Common quantitative techniques include experiments, observations that are recorded statistically, and thorough investigations. Finally, the researcher uses Google Forms to implement data gathering through internet channels.

### **Sampling**

Sampling is a research strategy in which data is collected from a segment of the population in order to make conclusions about the entire population. A "population" in this sense is often referred to as a "universe." According to Sedgwick, 2013, to describe study participants, there are two different sampling techniques that might be utilised: Random samples (sometimes called probability samples) and non-random samples (sometimes called non-probability

samples). Therefore, the number of people is large, the technique used by the researcher in the survey, and the population is a random sample that is not a probability sample.

Researchers utilise convenience sampling as a technique to get information for market research from a preexisting pool of respondents.. The data collected using this sample is used exclusively for scientific research purposes. This sampling approach relies on criteria such as ease of contact, ease of contacting the group, willingness of respondents to participate, low cost, inexpensive method, and ease of conducting the survey. In addition, a questionnaire should be prepared for all individuals who participate. This sample is conducted for 384 respondents where everyone can participate because the researcher wants to collect data from everyone throughout Malaysia. The target population is Malaysians. Overall, this method is related to surveys.

### **Data Analysis**

Data analysis is a method for assessing information using intellectual and scientific thought to investigate all aspects of the provided information that must be resolved. Information from various sources is collected, reviewed and categorized to determine the final outcome or type. With the sophistication of the computer, the researcher's information collected in this analysis will be analyzed using the Social Science statistical package Version 24 (SPSS). IBM SPSS version 24 is a set of comprehensive statistical tools to process statistical data and generate various results to answer research objectives. Next, the researcher used descriptive statistics, reliability statistics and Pearson's correlation to evaluate quantitative data.

## FINDINGS

### The Respondent's Demographic Profile

Table 1: Demographic Profile of Sample

Characteristic		Frequency	%
Gender	Male	123	32
	Female	261	68
Age	20 – 25 years old	326	84.9
	26 – 30 years old	25	6.5
	31 – 35 years old	11	2.9
	35 – 40 years old	10	2.6
	Above 40 years old	12	3.1
Race	Malays	341	88.8
	Chinese	29	7.6
	Indian	9	2.3
	Iban	5	1.3
Marital Status	Married	40	10.4
	Single	344	89.6
Education Level	SPM / STPM	49	12.8
	Diploma	67	17.4
	Degree	262	68.2
	Master	6	1.6
Occupation	Full-Time Employee	72	18.8
	Part-Time Employee	24	6.3
	Unemployed	4	1
	Self – employed	13	3.4
	Student	271	70.6

Table 1 presents an overview of the responder profile. First of all, look at the gender of the respondent. As humans know that there are only two genders, male and female. The total number of male respondents is 123, while the total number of female respondents is 261. A total of 384 respondents participated in this study, with 32% of them being male and the remaining 68% being female.

Next, also look at the age of the respondents found in the study. There were 384 respondents which consisted of 326 respondents from the category 20 - 25 years old respondents equal to 84.9%, respondents from the category 26 - 30 years old respondents equal to 6.5%, respondents from the category 31 - 35 years old respondents equal to 2.9%, respondents from the category 35 - 40 years old respondents equal to 2.6% and respondents from the category 40 years old and above respondents equal to 3.1% had responded to questionnaire. Then, went to the race and the researcher found that there were 384 respondents who consisted of 341 respondents equal to 88.8% for the category of Malays, 29 respondents equal to 7.6% for the category Chinese, 9 respondents equal to 2.3% for the category Indian and 5 respondents equal to 1.3% for the category Iban had responded to the questionnaire.

After that, the data was shown that the single status consumes more fast food which is 344 respondents equal to 89.6% compared to the married status which is only 44 respondents which is equal to 10.4%. Besides, the educational level shows there were 384 respondents who were consisted of 49 respondents equal to 12.8% for the category SPM / STPM, 67 respondents equal to 17.4% for the category Diploma, 262 respondents equal to 68.2% for the category Degree and 6 respondents equal to 1.6% for the category Master had responded to questionnaire. Finally, Table 1 shows the respondents by occupation. The total number of respondents is 384 respondents. Respondents for full - time employee is 72 respondents equal to 18.8%. Then, respondents for part - time employee is 24 respondents equal to 25.0%. Next, respondents for unemployed is 4 equal 1.0%, and respondents for self - employed is 13 respondents equal to 3.4%. The last respondents are students with the 271 respondents equal to 70.6% who contributed to this study.

## Reliability Test

Reliability analysis was used to measure the reliability of questionnaires. Before discovered the actual questionnaire, researcher had performed in pilot test section, which is conduct 30 respondents to test before the questionnaire was distributed to 384 respondents. This is to know, that the questionnaires are reliable and validity of the variable. Cronbach's Alpha analysis was used to evaluate the data in order to guarantee the reliability and coherence of information.

Table 2: Result of Reliability Test

Variable	Number of Item	Cronbach's alpha coefficient	Strength of association
Customer loyalty in Malaysia's fast-food restaurants	4	0.841	Very good
Tangibles	4	0.853	Very good
Reliability	4	0.874	Very good
Assurance	4	0.858	Very good
Empathy	4	0.825	Very good
responsiveness	4	0.865	Very good

Table 2 above is a measure for the dependability of dependent and independent variable analyses in pilot tests. The questionnaire has a Cronbach's alpha more than 0.6, which is over the threshold for good and dependable reliability. As a result, the test can be applied and accepted in this study, according to the results. Next, there were four questions in the dependent variable, which is customer loyalty in Malaysia fast food restaurants. This section's the Cronbach's Alpha coefficient result is 0.841, which is considered to be very

good. As a result, the responses to the variable's questions' coefficients were valid and supported. There are five independent variables in a reliability analysis. The quantifiable variable was measured using four questions.

Table 2 also showed that, this question had a very good Cronbach's Alpha score of 0.853. Then, the coefficient obtained for the questions in personal variable were reliable. The second variable in Independent Variables is reliability and have four questions correctly, thus the Cronbach's Alpha value for these sections is 0.874 and the remark is very good. The other Independent Variables is assurance and empathy which also have four questions. Therefore, the coefficient obtained for these questions were also reliable. The result in Cronbach's Alpha is 0.858 and 0.825, and it is very good. Responsiveness was identified as the last item in the Independent Variables and has four questions in this section. Besides, the coefficient obtained from the result is 0.865 and it is very accepted. Last, all of the response was very well comprehended and accepted in this study, as shown by the reliability,

### **Descriptive Analysis**

The mean and standard deviation of this study have been examined in section C, which includes all the research questions presented to the respondents

Table 3: Descriptive Statistic

<b>Variables</b>	<b>N</b>	<b>Mean</b>	<b>Standard Deviation</b>
Tangibility	384	1.83	0.65
Reliability	384	2.10	0.75
Assurance	384	1.95	0.68
Empathy	384	1.95	0.66
Responsiveness	384	1.89	0.68

Table 3 displayed the total number of responses, as well as the mean value and standard deviation for both independent and dependent variables. Reliability, with a mean of 2.10% for independent variables, had the highest mean. The second highest variable was assurance and empathy with the same score 1.9%. Next, responsiveness mean score is 1.89% and the lowest score is tangibility which is 1.83%.

### Pearson's Correlation

The Pearson Correlation Coefficient analysis is a crucial tool for finding the statistical correlation or relationship between independent variables (IV) and dependent variables (DV). The objective of this analysis is to identify whether the independent variables are correlated, which is Tangibility, Reliability, Assurance, Empathy and Responsiveness and Dependent Variable which is customer loyalty toward fast food restaurants in Malaysia. If a correlation was found, the strength and direction of the relationship between the variables needed to be determined.

### Hypothesis 1

H1a: There is a relationship between tangibility and customer loyalty towards fast food restaurants in Malaysia.

Table 4: Correlation coefficient for Tangibility and customer loyalty towards fast food restaurants in Malaysia.

		Customer	Tangibility
Customer	Pearson Correlation	1	.630**
	Sig. (2-tailed)		0
	N	384	384
Tangibility	Pearson Correlation	.630**	1
	Sig. (2-tailed)	0	
	N	384	384

Table 4 shows the significant value, the overall response rate (384), and the Pearson correlation coefficient. The p-value was 0.000, which was below than the significance level of 0.01. With a correlation value of 0.630, the tangibility item and customer loyalty towards a fast food restaurant in Malaysia shown a strong positive relationship.

## Hypothesis 2

H2a: There is a relationship between reliability and customer loyalty towards fast food restaurants in Malaysia.

Table 5: Correlation coefficient for Reliability and customer loyalty towards fast food restaurants in Malaysia.

		Customer	Reliability
Customer	Pearson Correlation	1	.483**
	Sig. (2-tailed)		0
	N	384	384
Reliability	Pearson Correlation	.483**	1
	Sig. (2-tailed)	0	
	N	384	384

Table 5 shows the total number of respondents (384), the Pearson correlation coefficient, and the significant value. The p-value was 0.000, below the level of significance of 0.01. With a correlation value of 0.438, the reliability item and customer loyalty towards a fast food restaurant in Malaysia showed a high positive relationship.

## Hypothesis 3

H3a: There is a relationship between assurance and customer loyalty towards fast food restaurants in Malaysia.



Table 6: Correlation coefficient for Assurance and customer loyalty towards fast food restaurants in Malaysia.

		Customer	Assurance
Customer	Pearson Correlation	1	.552**
	Sig. (2-tailed)		0
	N	384	384
Assurance	Pearson Correlation	.552**	1
	Sig. (2-tailed)	0	
	N	384	384

Table 6 shows the total number of respondents (384), the Pearson correlation coefficient, and the significant value. The p-value was 0.000, below the level of significance of 0.01. With a correlation value of 0.552, the assurance item and customer loyalty towards a fast food restaurant in Malaysia showed a strong positive relationship.

#### Hypothesis 4

H4a: There is a relationship between empathy and customer loyalty towards fast food restaurants in Malaysia.

Table 7: Correlation coefficient for Empathy and customer loyalty towards fast food restaurants in Malaysia.

		Customer	Empathy
Customer	Pearson Correlation	1	.565**
	Sig. (2-tailed)		0
	N	384	384
Empathy	Pearson Correlation	.565**	1
	Sig. (2-tailed)	0	
	N	384	384

Table 7 shows the total number of respondents (384), the Pearson correlation coefficient, and the significant value. The p-value was 0.000, below the level of significance of 0.01. With a correlation value of 0.565, the empathy item and customer loyalty towards a fast food restaurant in Malaysia showed a strong positive relationship.

## Hypothesis 5

H5a: There is a relationship between responsiveness and customer loyalty towards fast food restaurants in Malaysia.

Table 8: Correlation coefficient for Responsiveness and customer loyalty towards fast food restaurants in Malaysia.

		Customer	Responsiveness
Customer	Pearson Correlation	1	.599**
	Sig. (2-tailed)		0
	N	384	384
Responsiveness	Pearson Correlation	.599**	1
	Sig. (2-tailed)	0	
	N	384	384

Table 8 shows the total number of respondents (384), the Pearson correlation coefficient, and the significant value. The p-value was 0.000, below the level of significance of 0.01. The responsiveness item and customer loyalty towards Malaysia's fast food restaurant exhibited a strong positive relationship with a correlation value of 0.599.

## DISCUSSION AND RECOMMENDATION

The first recommendation of study is a perspective study on the importance of ensuring customer loyalty in business. This is because the importance of ensuring customer loyalty is that it can help a business grow more rapidly. In addition, research related to this topic will also give awareness to entrepreneurs to focus on customer loyalty. In addition, they can also do

research on customer loyalty not only in the field of fast food. They can also do research related to other businesses such as hospitality, transportation and telecommunications. Researchers can also conduct a study to open the eyes of entrepreneurs about the importance of providing good products and services to their customers in order to ensure that their customers will be loyal to the products and services they run. In addition, the researcher can also provide some of the best steps in ensuring customer loyalty. For example, giving promotions to customers, creating a member card system, and so on.

Therefore, customers will be more interested in choosing the products or services provided because they feel valued and get various benefits when they are loyal to the products and services offered. For the second recommendation, future research needs to use appropriate methods to obtain information related to customer loyalty. Researchers can obtain information by using quantitative methods, which is by conducting surveys. This will help the researcher in obtaining data about the research being conducted. In survey questions, researchers need to prepare questions that are appropriate to the study being conducted to facilitate respondents to provide accurate information to help them complete the study. In addition, the survey questions also need to be disseminated well in order to obtain a sufficient number of respondents to conduct their research. Researchers can use google form to prepare their questions. This is easier and more productive to make it convenient for responders to respond to the questions provided. Therefore, we hope that future researchers will use the suggestions given to help them in conducting research in ensuring customer loyalty.

## **CONCLUSION**

Finally, based on data collected from 384 respondents using Google Form, the researchers had successfully finished this research, which was titled "Measuring Perceived Service Quality Towards Customer Loyalty in Malaysia's Fast Food Restaurant.". The researcher identified the most important elements as follows for study objectives: tangibility, reliability, assurance, empathy and responsiveness as an important factor that must be present in ensuring customer loyalty in fast food restaurant services. Based on the statement of problems found in this study, there are several things that fast food restaurant operators need

to do in order to overcome this problem in order to increase customer loyalty to their products and services. The first problem statement is that fast food operators find it difficult to ensure that products and services produced are always in the best condition because this plays a major role in attracting the interest and loyalty for their customers. In addition, the quality of the food provided must also be constantly monitored to ensure that the quality of the food is always in a satisfactory condition to prevent customers from making complaints about the food provided.

## REFERENCES

- Akter, M., Sadekin, M. N., & Patwary, A. K. (2020). An Empirical Study on Students' Satisfaction from Mawlana Bhashani Science & Technology University, Bangladesh. *Review of Economics and Development Studies*, 6(2), 363-379.
- Alom, S., Patwary, A. K., & Khan, M. M. H. (2019). Factors affecting the turnover intention of Bangladeshi migrants in the United Arab Emirates: An empirical study on the hotel industry. *International Journal of Innovation, Creativity and Change*, 8(3), 344-360.
- Blose, J. E. & Tankersley, W. B. (2004). Linking dimensions of service quality to original outcomes. *Managing service quality*, 14(1), 75-89.
- Conceptions of library and information science; historical, empirical and theoretical perspectives: P. Vakkari and B. Cronin (eds.). Taylor Graham, London (1992). 314 pp. \$46.00, ISBN 0-947568-52-2
- Dictionary, legal (no date) *Legal dictionary, Law Insider*. Available at: <https://www.lawinsider.com/dictionary> (Accessed: 03 July 2023).
- Fengmin, Z., Baijun, W., Jiangtao, B., Li, L., & Patwary, A. K. (2022). Investigating revisit intention of medical tourists in China through nutritional knowledge, perceived medical quality, and trust in the physiologist: A recommendation on health tourism policy measures. *Frontiers in Public Health*, 10, 893497.
- Hazbar, A. M. H., Alem Mohammed, A., & Karim, A. K. A. (2019). An Empirical Study of Factors Influencing hotel customers' online booking Intention. *مجلة العلوم التربوية و الدراسات الإنسانية*, (5), 1-17.
- Li, L., Ragavan, N. A., Patwary, A. K., & Baijun, W. (2022). Measuring patients' satisfaction toward health tourism in Malaysia through hospital environment, nutritional advice, and perceived value: A study on Chinese exchange students. *Frontiers in public health*, 10, 893439.
- Li, L., Wu, B., & Patwary, A. K. (2022). How marine tourism promote financial development in sustainable economy: new evidences from South Asia and implications to future tourism students. *Environmental Science and Pollution Research*, 29, 1155-1172.
- Li, L., Wu, B., & Patwary, A. K. (2022). The psychosocial factors affecting chinese Outbound Exchange and mobility students' academic performance during COVID-19. *Frontiers in psychology*, 13, 872516.

- Moudatsou, M. *et al.* (2020) *The role of empathy in health and Social Care Professionals, Healthcare (Basel, Switzerland)*. Available at: <https://www.ncbi.nlm.nih.gov/pmc/articles/PMC7151200/> (Accessed: 03 July 2023).
- Parasuraman, A., Zeithaml, V. A., & Berry, L. L. (1988). SERVQUAL: A multipleitem scale for measuring consumer perception of service quality. *Journal of Retailing*, 64(1), 12-40. Research and Markets Report (2017). Fast food market by product type (pizza/pasta, burger/sandwich, chicken, Asian/Latin American food, seafood) - global opportunity analysis and industry forecast, 2014-2022. <http://www.researchandmarkets.com/reports/4058663/fast-food-marketby-product-type-pizzapasta#pos-2> retrieved on 1 March 2017.
- Patwary, A. K., Roy, B., Hoque, R., & Khandakar, M. S. A. (2019). Process of developing a community based tourism and identifying its economic and social impacts: An Empirical study on Cox's Bazar, Bangladesh. *Pakistan Journal of Humanities and Social Sciences*, 7(1), 1-13.
- Philip M. Sedgwick (2013) (PDF) *convenience sampling - researchgate, Convenience sampling*. Available at: [https://www.researchgate.net/publication/291161903\\_Convenience\\_sampling](https://www.researchgate.net/publication/291161903_Convenience_sampling)
- Saghier, N. E. & Nathan, D. (2013). Service quality dimensions and customers' satisfaction of banks in Egypt. 20th International Business Research Conference, 4 - 5 April 2013, Dubai, UAE.
- Stephanie Glen. "Correlation Coefficient: Simple Definition, Formula, Easy Steps" From StatisticsHowTo.com: Elementary Statistics for the rest of us! <https://www.statisticshowto.com/probability-and-statistics/correlation-coefficient-formula/>
- Sumethokula, P., Patwary, A. K., Srinuanpanc, B., Srinuanpand, C., Suwandee, P., Thammathikul, A., & Phanong, W. (2020). The potential of new tour repackaging for creative tourism among entrepreneurs in Nakhon Si Thammarat. *International Journal of Innovation, Creativity and Change*, 13(10), 1752-1771.
- Wu, B., Liu, S., Wang, J., Tahir, S., & Patwary, A. K. (2021). Assessing the mechanism of energy efficiency and energy poverty alleviation based on environmental regulation policy measures. *Environmental Science and Pollution Research*, 28, 40858-40870.
- Wu, B., Zhai, B., Mu, H., Peng, X., Wang, C., & Patwary, A. K. (2021). Evaluating an economic application of renewable generated hydrogen: A way forward for green economic performance and policy measures. *Environmental Science and Pollution Research*, 1-15.

# **THE INFLUENCING FACTORS OF ONLINE REVIEWS AFFECTING CUSTOMER VISIT INTENTION TOWARDS FOOD AND BEVERAGE ESTABLISHMENT IN MALAYSIA**

NIK NUR AMIRAH BINTI NIK LUKMAN, NIK NUR MADIHAH BINTI HASSAN,  
NONINORDIANA A/P MATSOL , NIK NUR SHUHADA BINTI ARIFF & MAZNE  
BINTI IBRAHIM

*Faculty of Hospitality, Tourism and Wellness, Universiti Malaysia Kelantan  
Corresponding email: mazne@umk.edu.my*

---

## **ABSTRACT**

The goal of this study is to look at the elements that influence consumer visit intention to food and beverage outlets in Malaysia. Hence, this study investigates the factors that affecting the customer visit intention towards food and beverage establishment in Malaysia. To perform this analysis, a quantitative approach was used, and the questionnaire were distributed to collect the required information. The sample size of this study was conducted on 384 respondents who have visited the food and beverage establishment in Malaysia through online surveys which is Google form. For data analysis, reliability testing and Pearson correlation had been used by using the Statistical Package for the Social Sciences (SPSS) version 26. As a result, the analysis shows that the number of reviews, content of reviews and online rating have a significant relationship with customer visit intention towards food and beverage establishment in Malaysia.

***Keywords: Number of Reviews, Content of Reviews, Online Rating***

---

## **INTRODUCTION**

### **Background of the Study**

Online reviews are important components nowadays for consumers to decide to choose a suitable restaurant. Consumers rarely have access to direct information about product quality when they are making infrequent or distant purchases. They frequently rely on outside sources as a result (Browning, 2010). So, consumers can check the food and beverage establishment social media or look at the online reviews at the food and beverage establishment website. Online reviews have also improved as individuals can easily share their opinions with other internet users. Many of these social media platforms allow users to publish and share travel-related comments, ideas, and personal experiences, which are then shared with others. Consequently, a restaurant's impact from online reviews is significant. Reviews are crucial since 59% of prospective clients look at least 2-3 reviews before making a choice. Online reviews are crucial as they boost company reputation, drive sales, and improve the website's search engine rankings. The reputation may suffer if the website is empty of reviews. People believed that customer reviews are more reliable than what a local business may say about itself, which explains why (Kruessel, 2021). In this context, online reviews have a big impact whereby they can eliminate the potential conflicts of interest. This study tries to demonstrate how internet user reviews affect the profitability of food and beverage establishment in Malaysia.

In addition, on the study have several problems that should be solved it is an online customer review which is a type of consumer feedback or review of a good or service on different ecommerce websites by a customer who has bought and used the product. Due to non-restrictive websites and consumer reviews that are anonymous, the legitimacy and logic of these reviews have always been called into doubt. Because they are seen to be an inaccurate comment about a product or service, reviews might occasionally be in doubt. Then it is important to read restaurant online reviews as it provides the overview of the restaurant. Entrepreneurs need to understand how online reviews affect dining establishments since these reviews might make or ruin a company. Positive reviews increase a restaurant's revenue and patronage. As an alternative, having negative online rating, reviews, and content could affect how customers in Malaysia perceive food and beverage businesses.

This study is aiming to achieve several objectives as followed:

1. To identify the relationship between number of reviews and customer visit intention towards food and beverage establishment in Malaysia.
2. To identify the relationship between content of reviews and customer visit intention towards food and beverage establishment in Malaysia.
3. To identify the relationship between online rating and customer visit intention towards food and beverage establishment in Malaysia.

### **Significance of the Study**

According to the topic chosen from the influencing factors of online reviews affecting customer visit intention towards food and beverage establishment in Malaysia, Researchers investigate the relationship between independent variables (IV) and dependent variables (DV). which involved a number of reviews, content of reviews and online rating. The parties involved which can get advantages are food and beverage establishment operator restaurants, customers, and the future researchers. Food and beverage establishment operator is the company will in the end know what the important strategies are to improve their quality to attract more customer based on the online reviews they received. Customer is they will know which restaurant that have good feedback. Future researchers are aimed to contribute the clear information and address all new researchers on the information related to the factors of online reviews affecting customer visit intention towards food and beverage establishment.

## **LITERATURE REVIEW**

### **Number of Reviews**

Getting as many reviews as possible is simply beneficial to any company. Several favourable evaluations can overshadow a few unfavorable ones. In general, more positive evaluations will result in more sales, which in turn generate more feedback and put the company on the path to success. Accordingly, customers frequently use information from others to guide their decisions (Mitchell & McGoldrick, 1996; Zhang et al., 2010). In fact, 57% of consumers, according to Godes (2004) highlighted that customer tend to read online customer evaluations before making a purchase decision. The amount and quality of online customer evaluations have a significant impact on consumer information processing. Since it can be assumed that



the number of reviews is proportional to the number of consumers who have purchased or plan to visit the product. As a result, from the standpoint of message quantity, the more messages processed, the more favorable connections to its promotion are created (Petty & Cacioppo, 1984). The number of online customer reviews for a product shows the popularity of the product as online word of mouth. . When people want to know a nice spot to visit, for example, a food and beverage outlet, the more reviews there are, the more popular and significant the product is. In addition, the number of reviews is likely to cause consumers to reconsider their purchasing decisions.

### **Content of Reviews**

The content of reviews is a form of digital feedback that customers provide online about products and services. A customer review website provides an opportunity for customers to independently rate the business. For this era of technology, customers can share their feedback or opinion about the product with other people by writing their reviews on the online website of the respective restaurant. Customers reviews are very important in food and beverage establishment because the other potential customers tend to rely on the online comments which will allow them to obtain more information about the restaurant that they are interested (Ye, Law, Gu & Chen, 2011). Customers review or feedback are very essential since the customers' reviews can help the operator to improve what are the restaurant are lacking in the future. The content of reviews or feedback has a great influence on customers visit intention towards food and beverage establishment in Malaysia.

### **Online Ratings**

Online reviews consist of voluntary, user-generated evaluations of a company, product or service by Internet users who have purchased, used, or experienced the product or service in question. This online rating is the overall rating which the consumers give to the business they are visiting. Ratings or feedback given on content in the review area consist a positive and negative comments through social media. Online reviews have replaced and supplemented older types of word-of-mouth regarding the quality of services, such as hotels and restaurants, as an essential source of information for consumers. In general, positive comments are more likely to create emotional trust in consumers, increase their confidence in the product, and be

more persuasive. Conversely, negative comments can reduce emotional trust formation and discourage consumer purchase intentions (Archak et al., 2010). Nowadays, people are more likely to shop on websites and the first thing they see before deciding on a menu and buying a menu is first the rating of the restaurant and then the rating of the menu that they want to buy. Ultimately, 86% of people would balance to do business with a company that has negative reviews online.

### **Research Hypothesis**

The study hypothesis is based on the impact of online reviews, such as number of reviews and online rating that affect the customer visit intention towards food and beverage establishment in Malaysia. Based on this study, the following hypotheses were developed and tested:

H1a: There is a relationship between number of reviews and customer visit intention towards food and beverage establishment in Malaysia.

H1o: There is no relationship between number of reviews and customer visit intention towards food and beverage establishment in Malaysia.

H2a: There is a relationship between content of reviews and customer visit intention towards food and beverage establishment in Malaysia.

H2o: There is no relationship between content of reviews and customer visit intention towards food and beverage establishment in Malaysia.

H3a: There is a relationship between online rating and customer visit intention towards food and beverage establishment in Malaysia.

H3o: There is no relationship between online rating and customer visit intention towards food and beverage establishment in Malaysia.

## Research Framework

There are three independent variables (IV) which are the number of reviews, content of reviews and online rating. The dependent variable for this research is customer visit intention towards food and beverage establishment in Malaysia.

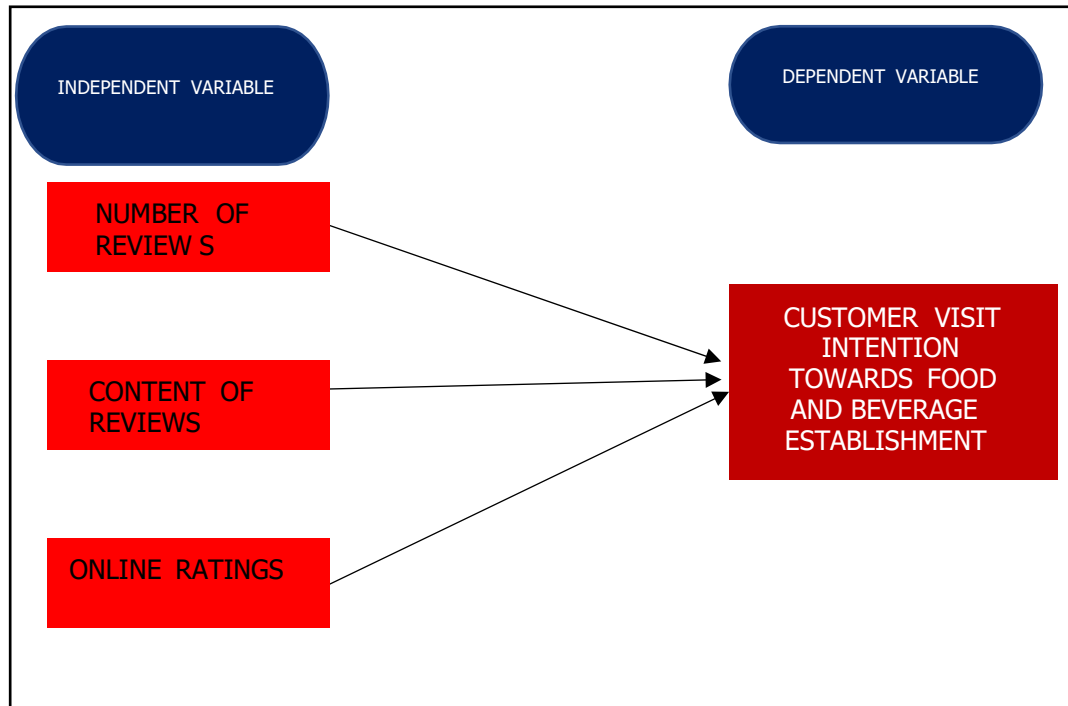

FIGURE 1: CONCEPTUAL FRAMEWORK

## METHODOLOGY

### Research Design

A study design is the framework of research methods and techniques chosen by researchers to conduct research (Bhat, 2018). Study design is also the process of collecting, analyzing, interpreting and reporting data in research studies (Creswell, 2015). In this research, the researchers used the quantitative approach to conduct this study. Quantitative research design involves measurable numerical data that researchers collect using surveys or questionnaires with multiple-choice questions (Houston, 2022). The quantitative research design such as questionnaire is the most used technique to collect data from the respondents for the research

questions. The aim of the study is to determine the influencing factors of online reviews affecting customer visit intention towards food and beverage establishment in Malaysia.

## **Population**

A populace is a finished gathering of people, whether that gathering incorporates a country or a gathering with normal qualities. In measurements, a populace is a gathering from whom a factual example is taken for research purposes. The study subjects consisted of all ethnic groups in Malaysia. The researcher also got a high level of diversity in the responses from the respondents because Malaysia has a diverse racial and cultural identity. Therefore, this study is very helpful and good because they are answers and views from different races and different ages. Nowadays, more and more people surf the internet and use social media regardless of age.

## **Sampling**

Sampling is a process in statistical research that collects a certain number of findings from a broader population. The technique utilised to survey a broader population is determined by the sort of study, which can be simple random sampling or systematic sampling (Boyle,n.d.). Sampling is a statistical analysis strategy that draws a defined number of outcomes from a larger population. According to Sedgwick (2013), there are two types of sampling procedures for recruiting research participants: random sampling (also known as probability sampling) and non-random sampling (also known as non-probability sampling). Researchers employ random sampling in non-probability sampling by considering the time factor for both the survey and the population. In non- probability sampling, researchers use random sampling by considering the time factor for both the survey and the population. A random sample is a type of non-probability sampling method in which the sample is drawn from a group of people who can be easily reached or contacted. The only requirement for the sampling approach is that participants are accessible and willing to participate (Nikolopoulou, 2022). Thus, the sample size for this study is targeted for 384 respondents where everyone can participate because the researchers aim to collect data throughout Malaysia since the target population is Malaysians.

## **Data Collection**

The data collection method employed for this study is through an online survey (Google form). Participants who lived in Malaysia are the target audience. There are no limitations on the age, gender, or ethnicity of customers. Participants were kindly asked to take this survey. The link to a survey page was built on a Google form, along with an explanation of the study's objectives, was sent via a personal account to respondents living in Malaysia through Facebook, Instagram, and WhatsApp to get the actual data.

## **Research Instrument**

Multiple-choice questions in the form of questionnaires are being used in this study. Options are presented to respondents for them to pick from. This questionnaire has the benefit of being swiftly and simply examined, either manually or digitally. Additionally, a number of higher-order thinking skills and a wide range of research subjects can be covered and evaluated by the test. The languages that were used to create this questionnaire were English and Malay. The goal of using this bilingual language is to make it easier for them to comprehend the questions and topics under investigation. Utilising Google Form, the survey will be created and circulated through all social media platforms, but particularly WhatsApp.

The survey questionnaire for this study was broken into three sections. Section A will ask for demographic information such as age, gender, , status, ethnicity, and income. The questions pertaining to the dependent variables, such as the variables impacting online reviews on customers' visit intent to Malaysian food and beverage establishments, will be the main emphasis of Section B, the second section. The questionnaire will then be connected to independent factors highlighted by researchers for Section C, such as the quantity of reviews, their substance, and internet ratings. The researchers incorporate information regarding the dependent variable, which is Malaysian consumers' desire to attend restaurants and bars, in this part.

## **Data Analysis**

Data analysis involves modifying, processing, and cleaning raw data to yield useful and relevant information that supports economic decision-making. This process provides useful

insights and data that reduce the risk associated with decision-making, often displayed in charts, graphs, tables and graphs (Kelley, 2022). To analyze the collected data and interpret the results of research the researcher had used the spreadsheet to organize and analyzing the responses. To make things easier to organize, they used the features in Google Sheets. It has a few practical tools that may use to examine data. Calculations like addition and subtraction are performed using formulas, whereas averages and counts are handled using functions. The data analysis in this study comprised of descriptive analysis reliability test.

## **RESULTS**

In this part, analysts talked about dependability examination, recurrence investigation, elucidating investigation, and Pearson connection coefficient investigation. Information results were acquired from 384 respondents. In this review, the analysts examined information gathered involving the Factual Bundle for the Sociologies (SPSS) adaptation 26.

### **Results of Reliability Analysis**

Before conducting actual data collection, the researchers conducted a pilot test with 30 respondents before distributing the questionnaire to 384 respondents. The results of the pilot test show that the reliability test is used for validation of variables. Questionnaire reliability was measured using reliability analysis. Data were tested using Cronbach alpha analysis to ensure information reliability and internal reliability. The table below shows the rule of thumb (2007) for the size of the Cronbach alpha coefficient.

Alpha Coefficient Range	Strength of Association
< 0.6	Poor
0.6 to < 0.7	Moderate
0.7 to < 0.8	Good
0.8 to < 0.9	Very Good
0.9	Excellent

**Table 1: Rules of Thumb of Cronbach's Alpha Coefficient Size (2007)**

The table above shows the general consistency (pilot trial) of the reliant and autonomous factor. The credibility Cronbach alpha value of the questionnaire should not be less than 0.6 as it is considered unreliable. The nearer the worth is to 1, the more dependable the inward consistency of the component.

Variable	Number of Item	Cronbach Alpha Coefficient	Strength of Association
Customer Visit Intention Towards Food and Beverage Establishment in Malaysia	5	0.863	Very Good
Number Of Reviews	5	0.838	Very Good
Content Of Reviews	5	0.902	Excellent
Online Rating	5	0.712	Good

**Table 2: Result of reliability coefficient Alpha for the Independent Variables and Dependent Variable**

The summed Cronbach alpha coefficients for the independent and dependent variables in this study are displayed in the table above. We can infer from the table that every variable is more than 0.6. As a result, the results can be used in this study and are trustworthy.

### Demographics Characteristic of Respondent

The fundamental examination of this study included recurrence investigation. Information in Segment An of the poll included inquiries regarding different segment factors of respondents, including orientation, age, race, conjugal status, and pay level.

The segment profiles of the 384 respondents are summed up in the table underneath.

**Table 3:Demographics Characteristic of Respondent**

<b>Gender</b>	<b>Frequency</b>	<b>Percentage</b>
<input type="checkbox"/> <b>Male</b>	163	42.4%
<input type="checkbox"/> <b>Female</b>	221	57.6%
<b>Race</b>		
<input type="checkbox"/> <b>Malay</b>	325	85%
<input type="checkbox"/> <b>Chinese</b>	23	6.0%
<input type="checkbox"/> <b>India</b>	15	3.9%
<input type="checkbox"/> <b>Others</b>	21	5.5%
<b>Age</b>		
<input type="checkbox"/> <b>18-20 years old</b>	28	7.3%
<input type="checkbox"/> <b>21-30 years old</b>	331	86.7%
<input type="checkbox"/> <b>31-41 years old</b>		
<input type="checkbox"/> <b>41 years old and above</b>	16	4.2%
	7	1.8%
<b>Marital status</b>		
<input type="checkbox"/> <b>Single</b>	251	91.4%
<input type="checkbox"/> <b>Married</b>	29	7.6%
<input type="checkbox"/> <b>Others</b>		
	4	1.0%
<b>Income level</b>		
<input type="checkbox"/> <b>RM1,000RM2,000</b>	330	85.9%



□ RM2,001RM3,001	28	7.3%
□ RM3,001RM4,001	11	2.9%
□ RM4,001RM5,000	10	2.6%
□ More than RM5,000	5	1.3%
<b>TOTAL</b>	384	100%

### Descriptive analysis

This study has examined the mean and standard deviation for segment B, C and D of questionnaires.

**Table 4 : Mean and Standard Deviation**

VARIABLE	N	MEAN	STANDARD DEVIATION
Number Of Reviews	384	3.8891	0.56262
Content Of Reviews	384	4.4099	0.60907
Online Rating	384	4.0891	0.53268
Customer Visit Intention	384	3.9720	0.59493

Table 4 shows the number of respondents, the means and standard deviations of the independent and dependent variables. Among the independent variables, content of reviews had the highest average of 4.4099, followed by online reviews with 4.0891 for him and number of reviews with 3.8891. The mean of the dependent variable was 3.9720.

## Result of Correlation Coefficient

An important analysis that measures the statistical correlation or relationship between a independent variable (IV) and a dependent variable (DV) is the Pearson correlation coefficient study. Researchers need to determine the degree and direction of association between variables before finding correlations. Pearson's correlation coefficient indicates the strength of the relationship between two variables. A popular correlation in linear regression is Pearson's correlation, usually referred to as Pearson's R correlation. The goal of this research was to see if there was any relationship between the dependent variable customer visit intention towards Malaysian food and beverage establishments and the independent variables review quantity, review quality, and online rating.

**Table 5:Result of Correlation Coefficient**

### Correlations

		customer	Number	Content	Online Rating
customer	Pearson Correlation	1	.724**	.179**	.615**
	Sig. (2-tailed)		.000	.000	.000
	N	384	384	384	384
Number	Pearson Correlation	.724**	1	.345**	.682**
	Sig. (2-tailed)	.000		.000	.000
	N	384	384	384	384
Content	Pearson Correlation	.179**	.345**	1	.615**
	Sig. (2-tailed)	.000	.000		.000
	N	384	384	384	384
Online Rating	Pearson Correlation	.615**	.682**	.615**	1
	Sig. (2-tailed)	.000	.000	.000	
	N	384	384	384	384

\*\* . Correlation is significant at the 0.01 level (2-tailed).

Data analysis showed that content of reviews had the highest average value of 4.4099 among other variables. The highest Pearson correlation coefficient between factors influencing customer visit intention towards food and beverage establishment in Malaysian was number of reviews with 0.724, followed by 0.615 for online rating, and finally 0.179 for content of reviews. In summary, significant relationship were found between the independent variables, number of reviews, content of reviews, online rating, and the dependent variable, which is the customer visit intention towards food and beverage establishment in Malaysia.

### **Finding and Discussion**

30 respondents were used for reliability testing before the Google Forms online survey method used to collect a data from 384 respondents. A range of Cronbach alpha coefficients from 0.7 to 0.9 was tested, and good results were shown when the highest Cronbach alpha value was 0.902, followed by the customer visit intention towards food and beverage establishments in Malaysia with 0.863, followed by the number of reviews at 0.838, and lastly was online ratings at 0.712. Therefore, all variables met the minimum requirement as all Cronbach alpha coefficients were significantly greater than 0.6 for all variables.

In the descriptive analysis of the independent variables, content of reviews had the highest mean score of 4.4099, followed by online rating with the second highest mean score of 4.0981, followed by the dependent variable, customer visit intention towards food and beverage establishment in Malaysia with scored 3.9720. The lowest mean for the independent variable was the number of reviews at 3.8891. From this, we can conclude that content of reviews was the biggest factor influencing customers visit intention towards food and beverage establishment in Malaysia. The study's three objectives were three variables, and the researchers used a correlation analysis to determine the linear relationship between them. The correlation study is summarised in

Table 6, which reveals a strong association between the quantity, quality and intention of online reviews and consumer visits to Malaysian restaurants and bars.

**Table 6: Summary of Correlation Analysis**

Hypothesis	Significant Value	Conclusion	Correlation Value	Conclusion
1	0.000	Accepted	0.724	High positive correlation
2	0.000	Accepted	0.179	Negligible correlation
3	0.000	Accepted	0.615	Moderate positive correlation

**Table 6: Summary of Correlation Analysis**

**Limitations**

Like different examinations, this concentrate additionally had own limits made it challenging for analysts to finish this review. This study had a few limits, one of the impediments was factors. The review zeroed in just on three autonomous factors, number of surveys, content of audits, and web-based rating, and one ward variable, client visit aim towards food and refreshment foundation in Malaysia. This was on the grounds that analysis had restricted assets and references to concentrate on other free factors. The next limitation in this study is the data collection method. Only online surveys were employed by the researchers in this study to gather data. The fact that researchers cannot verify the accuracy of the data provided by respondents when utilizing online surveys presents a problem. Additionally, the number of respondents is one of the limitations of this study. Not all Malaysians can participate in this study by answering questions or receiving questionnaires from researchers and think if they answer will waste their time. The last limitation in this research is relying on the research design which employed quantitative approach. There is no study extension as this study focuses only on quantitative studies. Unless further research, especially qualitative research, is

conducted on this study, other researchers will not be able to know more about the influencing factors of online ratings for Malaysian food and beverage companies.

### **Recommendations**

In conducting this research, the researchers discovered several things that could be improved through online ratings that influence customers visit intention towards food and beverage establishment in Malaysia. Recommendation for food and beverage establishment operator, restaurants can enhance their food rating system by adding a comment section to each menu item in their restaurant. The Chicken Chop menu, for example, has a comment section and Likert scale that customers can fill in after the meal and give help to other customer by reading their comment and can fulfil their desires. Additionally, restaurants can harness the power of virality to promote their restaurants on social media. Recommendation for future researcher the study suggests that further research could be conducted for those wishing to follow relevant studies focused on establishing specific food and beverage. For example, they can focus on the elements of online reviews for restaurants that only serve western food. Researchers can get more detailed answers about all kinds of food, whether it is western or traditional cuisines.

### **Conclusion**

This study explores the relationships between the number of reviews, content of reviews and online rating variables that influence customer visit intention towards food and beverage establishment in Malaysia. There were 384 respondents had partaken in this study through a web-based overview technique. Information were gathered and investigated by involving the Measurable Bundle for the Sociologies (SPSS) adaptation 26 in view of graphic, dependability and connection examination. The aftereffects of the dependability examination showed that the outcomes introduced in this study were solid.

### **REFERENCES**

- Akter, M., Sadekin, M. N., & Patwary, A. K. (2020). An Empirical Study on Students' Satisfaction from Mawlana Bhashani Science & Technology University, Bangladesh. *Review of Economics and Development Studies*, 6(2), 363-379.
- Al Mahmud, S. R. (2020). The effectiveness of Facebook advertisements on purchase intention of customers in Malaysia. *South Asian Journal of Social Sciences and Humanities*, 1(1), 97-104.

- Alom, S., Patwary, A. K., & Khan, M. M. H. (2019). Factors affecting the turnover intention of Bangladeshi migrants in the United Arab Emirates: An empirical study on the hotel industry. *International Journal of Innovation, Creativity and Change*, 8(3), 344-360.
- Fengmin, Z., Baijun, W., Jiangtao, B., Li, L., & Patwary, A. K. (2022). Investigating revisit intention of medical tourists in China through nutritional knowledge, perceived medical quality, and trust in the physiologist: A recommendation on health tourism policy measures. *Frontiers in Public Health*, 10, 893497.
- Hazbar, A. M. H., Alem Mohammed, A., & Karim, A. K. A. (2019). An Empirical Study of Factors Influencing hotel customers' online booking Intention. *مجلة العلوم التربوية و الدراسات الإنسانية*, (5), 1-17.
- Kelley, K. (2022, 12 29). What is Data Analysis? Methods, Process and Types Explained. Retrieved from SimpliLearn: <https://www.simplilearn.com/data-analysis-methods-process-types-article>
- Li, L., Ragavan, N. A., Patwary, A. K., & Baijun, W. (2022). Measuring patients' satisfaction toward health tourism in Malaysia through hospital environment, nutritional advice, and perceived value: A study on Chinese exchange students. *Frontiers in public health*, 10, 893439.
- Li, L., Wu, B., & Patwary, A. K. (2022). How marine tourism promote financial development in sustainable economy: new evidences from South Asia and implications to future tourism students. *Environmental Science and Pollution Research*, 29, 1155-1172.
- Li, L., Wu, B., & Patwary, A. K. (2022). The psychosocial factors affecting chinese Outbound Exchange and mobility students' academic performance during COVID-19. *Frontiers in psychology*, 13, 872516.
- Nikolopoulou, K. (2022, August 9). What Is Convenience Sampling? | Definition & Examples. Scribbr. Retrieved January 5, 2023, from <https://www.scribbr.com/methodology/convenience-sampling/>
- Park, D. H., Lee, J., & Han, I. (2007). The effect of online consumer reviews on consumer purchasing intention: The moderating role of involvement. *International journal of electronic commerce*, 11(4), 125-148.
- Patwary, A. K., Roy, B., Hoque, R., & Khandakar, M. S. A. (2019). Process of developing a community based tourism and identifying its economic and social impacts: An Empirical study on Cox's Bazar, Bangladesh. *Pakistan Journal of Humanities and Social Sciences*, 7(1), 1-13.
- Paul C. Price, Rajiv Jhangiani, & I-Chant A. Chiang. (n.d.). Reliability and Validity of Measurement – Research Methods in Psychology – 2nd Canadian Edition. BCcampus Open Publishing. Retrieved January 5, 2023, from <https://opentextbc.ca/researchmethods/chapter/reliability-and-validity-of-measurement/>
- Petty, R.E., and Cacioppo, J.T. The effects of involvement on response to argument quantity and quality: Central and peripheral routes to persuasion. *Journal of Personality and Social Psychology*, 46, 1 (1984), 69–81. 35.
- Riadh Ladhari, & , Mélissa Michaud. (2015). eWOM effects on hotel booking intentions, attitudes, trust, and website perceptions. *International Journal of Hospitality Management*, (the study of the influence of comments written by Facebook friends on the intentions of booking a hotel, the trust in the hotel, the attitude toward the hotel,

and the perception of its website.), 44.  
[file:///C:/Users/HP/Downloads/eWOM\\_effects\\_on\\_hotel\\_booking\\_intentions.pdf](file:///C:/Users/HP/Downloads/eWOM_effects_on_hotel_booking_intentions.pdf)  
<https://www.searchenginejournal.com/google-explains-negative-reviewsrankings/376774/#close>

- Sedgwick, P. (2013) Convenience Sampling. *British Medical Journal*, 2013, 347.<https://doi.org/10.1136/bmj.f6304>
- Sparks, B. A., & Browning, V. (2011). The impact of online reviews on hotel booking intentions and perception of trust. *Tourism management*, 32(6), 1310-1323.
- Sumethokula, P., Patwary, A. K., Srinuanpanc, B., Srinuanpand, C., Suwandee, P., Thammathikul, A., & Phanong, W. (2020). The potential of new tour repackaging for creative tourism among entrepreneurs in Nakhon Si Thammarat. *International Journal of Innovation, Creativity and Change*, 13(10), 1752-1771.
- Wu, B., Liu, S., Wang, J., Tahir, S., & Patwary, A. K. (2021). Assessing the mechanism of energy efficiency and energy poverty alleviation based on environmental regulation policy measures. *Environmental Science and Pollution Research*, 28, 40858-40870.
- Wu, B., Zhai, B., Mu, H., Peng, X., Wang, C., & Patwary, A. K. (2021). Evaluating an economic application of renewable generated hydrogen: A way forward for green economic performance and policy measures. *Environmental Science and Pollution Research*, 1-15.
- Ye, Q., Law, R., & Gu, B. (2009). The impact of online user reviews on hotel room sales. *International Journal of Hospitality Management*, 28(1), 180-182.

# **The Influence of Workplace Deviant Behavior Towards Employee Performance in Malaysia Hotel Industry**

**Noorhelriyani Mat, Nor Ibtisam Hazzwani Che Daud, Norasmida Farhan, Nordiana Mainin, \*Nor Amira Mohd Razali, Mazne Ibrahim**

*Faculty Hospitality, Tourism and Wellness of University Malaysia Kelantan*

*Email: h20a1364@siswa.umk.edu.my, h20a1385@siswa.umk.edu.my, h20a1403@siswa.umk.edu.my, h20a1408@siswa.umk.edu.my, noramira.mr@umk.edu.my, mazne@umk.edu.my*

## **ABSTRACT:**

*This study investigates the influence of deviant workplace behavior, namely organizational justice, organizational constraints, trust in the organization, and work autonomy, on employee performance within the Malaysian hotel industry. This study employed a quantitative approach where 140 questionnaires were distributed to individuals working in hotels in Kota Bharu, Kota Kinabalu, Kuantan, and Georgetown. Data collection was conducted through convenient sampling using an online survey. The findings of this study indicate that organizational justice, organizational constraints, trust in the organization, and work autonomy significantly impact employee performance within the hotel industry. By offering a comprehensive understanding of the factors influencing employee performance in the hotel industry, this research contributes to existing theories and practical applications.*

**KEYWORD:** Deviant Behaviour, Organisational Justice, Trust in Organisational, Work Autonomy, Employee Performance.

## **INTRODUCTION**

Hotel businesses' success heavily relies on their employees' performance, mainly due to the emphasis on service as the primary product. Employees providing exceptional service to guests increases guest satisfaction and generate more income for the business. Malaysia's hotel industry employed approximately 196.4 thousand people in 2021 (United Nations World Tourism Organization [UNWTO]). However, the prevalence of high crime rates in Asia, including the Philippines, has escalated deviant behavior from minor to severe forms, observable in various locations. In recent years, the rates of reported bad behavior among adolescents have reached alarming levels, prompting concerns from the Department of Social Welfare and Development (DSWD) in the Philippines. Notably, deviant behaviors with negative impacts on others, such as lawbreaking, rape, robbery, theft, murder, juvenile delinquency, assaults at school, bullying,



vandalism, addictions, and substance abuse, have gained particular attention, as highlighted by articles in the Philippines Crime and Safety Report published in 2017 (Psychol, 2021).

Furthermore, the issue of workplace deviance has received considerable attention in Malaysia, as evidenced by frequent reports of dishonesty, absenteeism, accidents, employee turnover, bribery, poor work attitudes, and industrial accidents in newspapers and other public media sources. The gravity of workplace deviant behavior has captured the interest of relevant government bodies and the local media, which have highlighted these problems. Consequently, this study explores the relationships between organizational justice, organizational constraints, trust, and work autonomy, with employee performance in the Malaysian hotel industry. By examining these factors, the study seeks to contribute to understanding the impact of workplace deviance on employee performance and provide insights for effective management strategies in the hotel industry.

The findings of this research will be beneficial to hotel practitioners and operations, as it will provide valuable insights into the strategies necessary to enhance service quality and attract a more extensive customer base based on online reviews. Furthermore, hotel employees can benefit from this study by gaining awareness of the consequences of engaging in deviant behavior within the hotel industry. This knowledge can serve as a deterrent, encouraging employees to refrain from harmful actions. Additionally, the Ministry of Human Resources and labor departments can utilize the findings of this study to improve employee behavior and promote positive work environments. Future researchers can also build upon this study by further investigating the impact of online reviews in related fields.

## **LITERATURE REVIEW**

### **Organizational Justice**

Organizational justice is a critical area of study that explores the psychological processes underlying individuals' fairness judgments and their subsequent effects. It encompasses two primary dimensions: distributive justice and procedural justice. Job satisfaction among employees is closely linked to their perception of organizational justice. Employees who perceive fairness in their workplace are likelier to experience heightened engagement and commitment to their work.

Conversely, cynical employees who perceive corporate injustice and a lack of ethical norms are more inclined towards deviant behavior, including tardiness, absenteeism, theft of company property or information, sabotage, and dishonesty. The influence of organizational justice extends beyond job satisfaction, as it significantly impacts employees' overall attitudes, either positively or negatively.

Employers are vested in comprehending the dynamics within their workplace and implementing strategies to mitigate employee deviant behavior. However, it is worth noting that Rowland and Hall (2012) discovered a negative direct relationship between organizational justice and employee performance. This discovery suggests that certain factors influence the link between organizational justice and performance, warranting further investigation and analysis in this area.

### **Organizational Constraints**

Organizational constraints refer to the factors within the immediate work environment that hinder the translation of motivation and skills into effective job performance. These situational limitations impede employees from carrying out their responsibilities in line with organizational expectations, resulting in turnover, dissatisfaction, and negative emotions. In the hotel industry context, organizational constraints may encompass inadequate training, excessive workloads, unsocial work hours, and job overload. Employees who perceive themselves as restricted by these circumstances are more prone to engage in illicit behaviors at work, which can harm the company and its stakeholders.

Workplace deviance encompasses a broad range of behaviors impacting individuals and organizations. It can be categorized into four main types: production deviance, property deviance, political deviance, and employee aggression. Interpersonal deviance pertains to deviant behaviors targeting individuals, while organizational deviance focuses on actions that undermine the organization. Previous research on organizational constraints has primarily focused on assessing variables associated with these constraints rather than establishing causal relationships. However, interruptions from others are more specific and readily understandable, and they are more likely to impact customer satisfaction due to their uncontrollable nature.

Organizational constraints influence two key aspects: employees' perceptions of the limitations and the overall work environment. Personality traits such as negative affectivity, anger,

and agreeableness demonstrate the strongest relationships with perceived constraints from colleagues, supervisors, and inadequate resources. However, the literature has yet to extensively explore the causal relationships between organizational constraints and related variables. Further investigation is needed to understand better these relationships' intricacies and their implications for employee attitudes and behaviors in the hotel industry.

### **Trust In Organization**

Trust can be defined as the willingness of one party to place themselves in a vulnerable position, relying on the actions of another party. It entails an expectation that the other party will undertake specific activities that are crucial for the trustor's benefit, irrespective of their ability to monitor or control these actions and the inherent uncertainties surrounding the motivations, intentions, and potential behaviors of the other party. In the organizational context, organizational trust refers to an employee's belief that the organization will engage in actions that are advantageous to them or, at the very least, not detrimental.

Various contextual factors influence the development of trust within an organization. These factors shape the perceptions and beliefs of employees regarding the organization's trustworthiness. Understanding the contextual factors that impact organizational trust is vital for comprehending workplace confidence dynamics.

### **Work Autonomy**

Workplace autonomy refers to the extent to which employees have the freedom to carry out their job responsibilities. It encompasses the rate at which work is completed, the sequence in which tasks are undertaken, and the degree of independence from micromanagement. Existing research has highlighted a positive association between deviant behavior, such as fraud and theft, and the level of opportunity or autonomy granted to employees. Job autonomy empowers employees to make decisions and exercise discretion most properly. The interplay between job stress, job autonomy, and employee behavior is significant, as it can lead to feelings of frustration, aggravation, irritation, impatience, and intolerance. Employees' confidence in executing their tasks also influences the relationship between job factors and deviant behavior in the workplace.

Employers need more job autonomy to ensure employees utilize legitimate means to regain power and resources. Lawrence and Robinson (2007) demonstrated that reduced autonomy is a source of frustration, ultimately leading to deviant behavior. Conversely, individuals who experience high job satisfaction show elevated enthusiasm, reduced exhaustion, and a sense of significance and engagement in their work. By fostering an organizational environment that allows for reasonable autonomy, the organization can effectively mitigate deviant behavior.

### **Employees Performance**

The purpose of this literature review is to offer an overview of available research on employee performance in Malaysia's hospitality sector. It looks at motivation, training and development, leadership, organizational culture, and work satisfaction as elements that impact employee performance. The evaluation also emphasizes the particular issues that the Malaysian hotel business faces, as well as the consequences for staff performance. These findings highlight the significance of addressing these elements in order to enhance staff performance and, as a result, the competitiveness and success of the Malaysian hotel business. This literature study, by exploring the numerous dimensions of employee performance in the Malaysian hospitality sector, gives a helpful insight into the elements that drive employee performance and exposes the industry's issues. These findings can help hotel managers and policymakers establish effective ways for improving employee performance, increasing work satisfaction, and maintaining a competitive edge in Malaysia's dynamic hospitality industry.

### **RESEARCH HYPOTHESIS**

Organizational justice, organizational constraints, trust in the organization, and work autonomy are independent variables influencing employee performance in the Malaysian hotel industry. So, this research will investigate the following hypothesis for this study.

H1 : There is a relationship between organizational justice and employee performance in Malaysia hotel industry.

H2 : There is a relationship between organizational constraints and employee performance in Malaysia hotel industry.

H3 : There is a relationship between trust in organization and employee performance in Malaysia hotel industry.

H4 : There is a relationship between work autonomy and employee performance in Malaysia hotel industry.

## CONCEPTUAL FRAMEWORK

This study used a conceptual framework to analyze the relationship between independent and dependent variables in research. The conceptual framework for this study is shown in Figure 2.1 below.

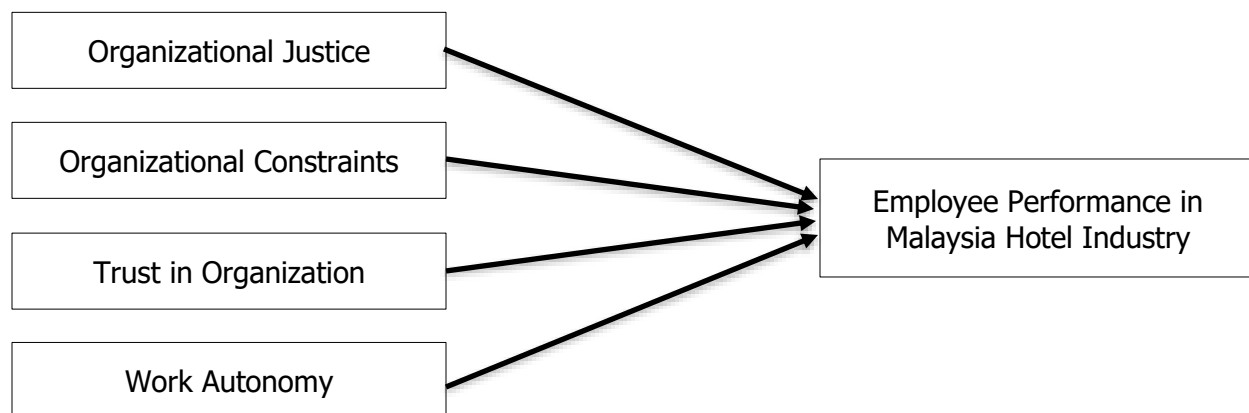

Figure 2.1: Conceptual Framework

Organizational justice, organizational constraints, trust in the organization, and work autonomy are the four independent variables in this study, which significantly impact employee performance in the Malaysian hotel industry.

## METHODOLOGY

### Research Design

The research design encompasses the methods and procedures employed to gather and analyze data related to the specified variables within the research problem. This study adopted a quantitative approach, utilizing a cross-sectional design where the researchers' collected data at a

single point in time. This research focused on investigating employee performance's influence on workplace deviant behavior within the Malaysian hotel industry.

### **Data Collection**

This research employed standard and validated data collection techniques to gather, measure, and analyze precise information relevant to the study. The primary data was collected through a questionnaire designed for this study, titled "The Influence of Workplace Deviant Behavior on Employee Performance in the Malaysian Hotel Industry." The researchers used online platforms such as Google Forms to collect the data, and suitable respondents were selected for the survey. The research employed a simple random sampling strategy, utilizing straightforward survey instruments to enhance the ease of response for the participants.

### **Sampling**

This study employs a non-probability convenience sampling technique to select participants from a readily accessible group of individuals employed in the Malaysian hotel industry. Convenience sampling is utilized as a time and cost-efficient method of participant selection, as it allows for the inclusion of easily reachable individuals. The questionnaire is administered in specific locations, namely Kota Bharu, Kelantan, Kota Kinabalu, Sabah, Kuantan, Pahang, and Georgetown, Pulau Pinang. Respondents are required to complete the questionnaire and provide statistical data based on their responses.

### **Data Analysis**

The Statistical Package for the Social Sciences (SPSS) is a widely utilized computer program for quantitative data analysis. It provides the capability to generate tabular reports, charts, and visual plots and employs the Pearson Correlation Coefficient method to analyze the collected data. This investigation aims to assess the relationship between the independent variables (IV) and the dependent variables (DV), specifically exploring the associations among organizational

fairness, organizational constraints, organizational trust, work autonomy, and employee performance.

## FINDINGS

### Demographic Analysis

Table 1: Demographic frequency (n) and percentage (%)

Demographic	Category	Frequency (n)	Percentage (%)
<b>Gender</b>	Male	50	35.7
	Female	90	64.3
<b>Race</b>	Cina	11	7.9
	India	8	5.7
	Melayu	84	60.0
	Others	37	26.4
<b>Religion</b>	Buddha	8	5.7
	Kristian	18	12.9
	Islam	106	75.7
	Others	8	5.7
<b>Age Group</b>	21 – 30 years old	127	90.7
	31 – 40 years old	12	8.6
	Below 20 years old	1	.7
<b>Education Level</b>	Degree	92	65.7
	Diploma	47	33.6
	Doctor Of Philosophy	1	.7
<b>Income Level</b>	Below RM 1,000	37	26.4
	RM 5,000 and above	2	1.4
	Rm 1,000 – RM 2,000	46	32.9
	RM 2,100 – RM 3,000	49	35.0
	RM 3,100 – RM 4000	6	4.3

The online platform collected a total of 140 sets of questionnaires from participants. This section presents the demographic profile and background of the respondents. Regarding gender, 35.7% (n=50) identified as male, while 64.3% (n=90) identified as female. Most respondents identified as Malay, accounting for 84 respondents (60.0%), followed by other races with 37 respondents (26.4%). The Chinese ethnicity was represented by 11 respondents (7.9%), while eight respondents (5.7%) identified as Indian. Islam was the predominant religion among the respondents, with 106 participants (75.7%), followed by 18 (12.9%) who identified as Christian. Eight respondents (5.7%) reported practicing Buddhism or other religions. Most respondents were 21-30 years old, with a frequency of 127 (90.7%). This category was followed by 12 respondents

(8.6%) in the age range of 31-40 years and one respondent (0.7%) below 20. Furthermore, Table 1 indicates that the highest educational attainment among respondents was a degree, accounting for 65.7% (n=92). This group was followed by 47 respondents (33.6%) who had completed a diploma and one respondent (0.7%) who held a Doctor of Philosophy (Ph.D.) degree. Lastly, regarding income level, the highest number of respondents, 49 (35.0%), reported an income range of RM 2,100 – RM 3,000. This group was followed by 46 respondents (32.9%) in the income range of RM 1,000 – RM 2,000. Thirty-seven respondents (26.4%) reported an income below RM 1,000. Six respondents (4.3%) reported an income range of RM 3,100 – RM 4,000, while the remaining two (1.4%) reported an income of RM 5,000 and above.

### **Descriptive Analysis**

The researchers employed descriptive analysis to describe the relationship between variables in a large sample or population, as Chapman (2017) suggested. The result of the descriptive analysis for this study is summarized in Table 2 below.

**Table 2: Descriptive Analysis Independent variable and Dependent variable**

<b>VARIABLES</b>	<b>MEAN</b>	<b>STANDARD DEVIATION</b>
DV: Employee Performance	4.5857	0.52180
IV 1: Organizational Justice	4.1893	0.64865
IV 2: Organizational Constraints	4.3411	0.61764
IV 3: Trust in Organization	3.7143	0.88022
IV 4: Work Autonomy	4.0500	0.79409

Table 2 presents the mean and standard deviation for independent variables (IV) and dependent variables (DV). Among the independent variables, organizational constraints obtained the highest mean score of 4.3411, followed by organizational justice with a mean of 4.1893, work autonomy with a mean of 4.0500, and trust in the organization with the lowest mean of 3.7143. The mean for the dependent variable, employee performance in the Malaysian hotel industry, was 4.5857. The analysis of mean and standard deviation for the dependent variable, employee performance, suggests that workplace deviant behavior can have a negative impact on employees' performance.



## Reliability Analysis

Table 3 shows the aggregate reliability for both the dependent and independent variables.

Table 3: Result of Reliability Coefficient Alpha for the Independent Variables and Dependent Variable

Variable	Number of Item	Cronbach's Alpha Coefficient	Strength of Association
Organizational Justice	4	0.802	Very Good
Organizational Constraints	4	0.794	Good
Trust in Organization	4	0.721	Good
Work Autonomy	4	0.947	Excellent

The Cronbach's Alpha coefficients for the independent and dependent variables in this study are presented in Table 3. As indicated in the table, all variables had coefficients exceeding 0.7. Therefore, it can be inferred that the results presented are trustworthy and acceptable for further analysis, as Hair et al. (2017) suggested.

Four questions were utilized to assess organizational justice's influence on employee performance. According to Table 4.2, Cronbach's Alpha coefficient for these questions was 0.802, indicating an outstanding level of reliability. Hence, the coefficients obtained for the organizational justice variable were deemed reliable. Similarly, four questions were employed to evaluate the organizational constraints variable's impact on employee performance. The Cronbach's Alpha value for this section was 0.794, indicating good reliability. Thus, the coefficients derived from the organizational constraints factor queries were considered reliable. Furthermore, four questions were used to measure the trust in the organization variable, which influenced employee performance. The Cronbach's Alpha coefficient was 0.721, suggesting good reliability. Therefore, the coefficients calculated for the trust in the organization factor queries were deemed reliable.

Lastly, four questions were employed to assess work autonomy and its relationship with employee satisfaction. This section's Cronbach's Alpha coefficient was 0.947, indicating good reliability. Therefore, the coefficients calculated for these questions in evaluating employee performance in the Malaysian hotel industry were also reliable.

Given that Cronbach's Alpha coefficients for these variables exceeded 0.7, the questionnaires demonstrated high reliability, indicating that participants understood the questions well. Consequently, the questionnaires were suitable for this investigation, and the research can proceed accordingly.

### Pearson Correlation Analysis

**Table 4: Pearson’s correlation between Organizational Justice, Organizational Constraints, Trust in Organizational and Work Autonomy toward Employee Performance in Malaysia Hotel Industry**

<b>Variable</b>		<b>Employee Performance</b>
<b>Organizational Justice</b>	Pearson Correlation	.279**
	Sig. (2 tailed)	<.001
	N	140
<b>Organizational Constraints</b>	Pearson Correlation	.581**
	Sig. (2 tailed)	<.000
	N	140
<b>Trust in Organization</b>	Pearson Correlation	.114
	Sig. (2 tailed)	<.178
	N	140
<b>Work Autonomy</b>	Pearson Correlation	.244**
	Sig. (2 tailed)	<.004
	N	140

\*\*Correlation is significant at the 0.01 level (2-tailed).

Table 4 presents the results of the Pearson correlation coefficient, significant values, and the number of responses (N=140) for this study. The findings revealed a strong positive correlation between organizational justice and employee performance in the Malaysian hotel industry. Organizational justice demonstrated a moderate positive relationship with employee performance in the Malaysian hotel industry, with a p-value of 0.000 and a correlation coefficient of 0.581. Furthermore, the Pearson correlation coefficient, significant values, and the number of 140 responses indicated a high significance level (p-value = 0.178) but a negligible correlation between trust in the organization and employee performance in the Malaysian hotel industry. Additionally, the Pearson correlation coefficient, significant values, and 140 responses showed a p-value of 0.004 and a correlation coefficient 0.244 between work autonomy and employee performance.

## DISCUSSION AND RECOMMENDATION

Based on the data collected and the findings presented in Table 4, a significant relationship between organizational justice and employee performance in the Malaysian hotel industry has been established. The results align with hypothesis H1, indicating that the perception of organizational justice significantly influences employee performance related to deviant behavior. These findings are consistent with existing research that consistently demonstrates organizational justice's impact on individual workplace behavior (Collquit, 2013). When employees perceive the evaluation outcomes or the decision-making processes for allocating outcomes to be unfair, they are more likely to exhibit negative behaviors, as Priesemuth (2013) suggested.

The findings from the data analysis in Table 4 reveal a positive correlation between organizational constraints and employee performance. These results support hypothesis H2, indicating that organizational constraints significantly impact deviant behaviors exhibited by employees that subsequently affect their performance. The responses collected from participants in the study largely agree that organizational constraints within the hotel industry, such as inadequate training, excessive workloads, unsocial work hours, and role overload, contribute to the manifestation of deviant behaviors. This finding is consistent with previous research conducted by Kim and Miao (2015), which established the presence of situational constraints within the hotel industry.

The results from the data analysis in Table 4 indicates a positive correlation between trust in the organization and employee performance within the Malaysian hotel industry. This finding aligns with hypothesis H3, which posits a relationship between the independent variable of organizational trust and employee performance. Trust in organizations is rooted in the framework of integrated social attachment exchange, wherein an employee's level of trust is influenced by past interactions with their employer and the expectation of future interactions being similar to those in the past. If an employee encounters negative interactions with the organization, it is anticipated that their trust in the organization will diminish, subsequently impacting their engagement in deviant behaviors. This notion is supported by Thau and Bennet (2007), who assert that a lack of organizational trust among workers influences their inclination toward engaging in deviant behaviors. Marasi (2016) also found a negative correlation between organizational trust and workplace deviance.

The findings in Table 4 reveals a positive correlation between trust in the organization and employee performance within the Malaysian hotel industry. This finding is consistent with hypothesis H3, which posits a relationship between the independent variable of organizational trust and employee performance. Trust in organizations is grounded in the framework of integrated social attachment exchange, where an employee's level of trust is shaped by their past interactions with the employer and their expectations for future interactions to resemble those in the past. When employees experience negative interactions with the organization, their trust in the organization is expected to diminish, subsequently influencing their inclination towards engaging in deviant behaviors. This notion is supported by Thau and Bennet (2007), who suggest that a lack of organizational trust among employees influences their propensity to exhibit deviant behaviors. Furthermore, Marasi (2016) found a negative correlation between organizational trust and workplace deviance. These findings collectively highlight the significance of trust in the organization as a determinant of employee performance and its implications for mitigating deviant behaviors in the workplace.

Regarding recommendations, future studies should encompass a broader context beyond the four countries in this research conducted in Malaysia. Expanding the scope of the study would enhance the understanding of the findings and allow for better generalization of the results. Additionally, while this study primarily focuses on the four aspects of organizational justice, organizational constraints, trust in the organization, and work autonomy, it is important to acknowledge that other influential factors may have been overlooked. These additional aspects may significantly impact employees' performance in the hospitality industry in Malaysia. Therefore, it is recommended that future researchers consider incorporating additional factors or elements to ensure a comprehensive analysis and obtain accurate results in their research endeavors.

## **CONCLUSION**

In conclusion, the primary objective of this empirical research was to explore the correlation between employee performance in the Malaysian hotel industry and several independent variables, namely organizational justice, organizational constraints, trust in the organization, and work autonomy. The study sought to contribute to the existing body of

knowledge by comprehensively understanding the factors influencing deviant workplace behavior and its impact on employee performance in the Malaysian hotel industry.

The research findings are expected to serve as a valuable resource for researchers and practitioners. By shedding light on the relationships between organizational justice, organizational constraints, trust, work autonomy, and employee performance, this study offers clear insights into the dynamics at play within the hotel industry. Furthermore, the findings will contribute to developing future research endeavors, particularly those investigating the influence of online reviews and related factors on employee performance.

The implications of this research extend beyond academia and hold practical value for hotel management and employees. By gaining a better understanding of the factors that contribute to deviant behavior in the workplace, organizations can develop effective strategies and policies to prevent and address such behaviors. These strategies, in turn, can foster a healthier and more productive work environment, benefiting both the organization and its employees. In conclusion, this empirical study provides significant contributions to understanding deviant workplace behavior and its impact on employee performance in the Malaysian hotel industry. The findings have implications for further research and practical applications, ultimately guiding efforts to mitigate deviant behavior and enhance employee performance in the hospitality sector.

## REFERENCES

- Abbasi, A., Ismail, W. K. W., Baradari, F., Zureigat, Q., & Abdullah, F. Z. (2022). Can organisational justice and organisational citizenship behaviour reduce workplace deviance? *Intangible Capital*, 18(1), 78-95.
- Akgunduz Y. The influence of self-esteem and role stress on job performance in hotel businesses. *Int J Contemp Hosp Manag* 27: 1082-1099, 2015.
- Akter, M., Sadekin, M. N., & Patwary, A. K. (2020). An Empirical Study on Students' Satisfaction from Mawlana Bhashani Science & Technology University, Bangladesh. *Review of Economics and Development Studies*, 6(2), 363-379.
- Alom, S., Patwary, A. K., & Khan, M. M. H. (2019). Factors affecting the turnover intention of Bangladeshi migrants in the United Arab Emirates: An empirical study on the hotel industry. *International Journal of Innovation, Creativity and Change*, 8(3), 344-360.
- Amanda Shantz, Kerstin Alfes, Catherine Truss & Emma Soane. (2015). The Role of Employee Engagement in The Relationship Between Job Design and Task Performance, Citizenship and Deviant Behaviours.
- Bennet RJ, Robinson SL. Development of a measure of workplace deviance. *J Appl Psychol* 85: 349-360, 2000.
- Bhardwaj P. Types of sampling in research. *J Pract Cardiovasc Sci* 2019; 5:157-63.
- Brezina. (2010). Main Factors That Drives Young People to Engage in Deviant Behaviour.

- Canadian Center of Science and Education. (2018). Promoting Autonomy to Reduce Employee Deviance: The Mediating Role of Identified Motivation.
- Chapman, S. J. (2017). Review of Discovering Statistics Using IBM SPSS Statistics, 4th Edition. *Journal of Political Science Education*, 14(1), 145–147.
- Department, S. R. (20 October, 2022). Number of people employed in the accommodation industry in Malaysia from 2012 to 2021.
- Fengmin, Z., Baijun, W., Jiangtao, B., Li, L., & Patwary, A. K. (2022). Investigating revisit intention of medical tourists in China through nutritional knowledge, perceived medical quality, and trust in the physiologist: A recommendation on health tourism policy measures. *Frontiers in Public Health*, 10, 893497.
- Gabriel. (2012). *International Journal of Business and Management*.
- Ghaderi, Z., Tabatabaei, F., Khoshkam, M., & Shahabi Sorman Abadi, R. (2021). Exploring the Halbusi, H. A., Ismail, M. N., & Omar, S. B. (2021). Ethical leadership and employee ethical behaviour: exploring dual-mediation paths of ethical climate and organisational justice: empirical study on Iraqi organisations. *International Journal of Business Governance and Ethics*, 15(3), 303-325.
- Hazbar, A. M. H., alem Mohammed, A., & Karim, A. K. A. (2019). An Empirical Study of Factors Influencing hotel customers' online booking Intention. *مجلة العلوم التربوية و الدراسات الإنسانية*, (5), 1-17.
- Junehee Kwon & Wansoo Kim. (2013). Effects of Attitudes VS Experience of Workplace Fun on Employee Behaviours: Focused on Generation Y in The Hospitality Industry.
- Kao FH, Cheng BS, Kuo CC, Huang MP. Stressors, withdrawal, and sabotage in frontline employees: The moderating effects of caring and service climates. *J Occup Organ Psychol* 87: 755-780, 2014.
- Kim MY, Miao Q, Park SM. (2015). Exploring the relationship between ethical climate and behavioral outcomes in the Chinese Public Sector: The mediating roles of affective and cognitive responses. *Int J Business, Humanit Technol* 5:88-103.
- Kong Hai-yan & Tom Baum. (2006). *Skills and Work in The Hospitality Sector*.
- Li, L., Ragavan, N. A., Patwary, A. K., & Baijun, W. (2022). Measuring patients' satisfaction toward health tourism in Malaysia through hospital environment, nutritional advice, and perceived value: A study on Chinese exchange students. *Frontiers in public health*, 10, 893439.
- Li, L., Wu, B., & Patwary, A. K. (2022). How marine tourism promote financial development in sustainable economy: new evidences from South Asia and implications to future tourism students. *Environmental Science and Pollution Research*, 29, 1155-1172.
- Li, L., Wu, B., & Patwary, A. K. (2022). The psychosocial factors affecting chinese Outbound Exchange and mobility students' academic performance during COVID-19. *Frontiers in psychology*, 13, 872516.
- Li, X., & Zeng, Y. (2019). How to reduce hospitality employees' deviant behavior: An organizational justice perspective. In *International Conference on Economics, Management and Humanities Science* (pp. 929-37).
- Mazni Alias, Chew Kok Wai, Zauwiyah Ahmad & Abdul Mutalib Azim. (2018). Workplace Deviant Behaviour among Malaysia hotel Employees. Does Organisational Factors Matter?
- Mazni Alias, Roziah Mohd Rasdi, Maimunah Ismail & Bahaman Abu Samah. (2013). Predictors of Workplace Deviant Behaviour: HRD Agenda for Malaysian Support Personnel.

- Naumann CL, Adkins SE. (2001) Situational constraints on the achievement – performance relationship: a service sector study. *J Organ Behav* 22:453-465.
- Patwary, A. K., Roy, B., Hoque, R., & Khandakar, M. S. A. (2019). Process of developing a community based tourism and identifying its economic and social impacts: An Empirical study on Cox's Bazar, Bangladesh. *Pakistan Journal of Humanities and Social Sciences*, 7(1), 1-13.
- Perkbox. (2022). How to Encourage Employee Autonomy.
- Pieters, W. R. (2018). Assessing organisational justice as a predictor of job satisfaction and employee engagement in Windhoek. *SA Journal of Human Resource Management*, 16(1), 1-11.
- Pindek, S & Spector, P.E. (2016). Organizational constraints: A meta-analysis of a major stressor. *Work & Stress*, 30(1), 7-25. 2016.
- Rae, K., & Subramaniam, N. (2008). Quality of internal control procedures: Antecedents and moderating effect on organisational justice and employee fraud. *Managerial Auditing Journal*.
- Ranto, D. W. P., Tjahjono, H. K., Muafi, M., & Prajogo, W. (2022). The Influence of Organizational Justice on Interpersonal and Organizational Deviance: A Conceptual Paper. *International Journal of Marketing & Human Resource Research*, 3(2), 87-97.
- Role of Perceived Organizational Justice and Organizational Commitment as Predictors of Job Satisfaction among Employees in the Hospitality Industry. *International Journal of Hospitality & Tourism Administration*, 1-30.
- Roopa. (2017). Questionnaire Designing for a Survey.
- Rosid, A., Najmudin, N., & Suwanto, S. (2020). The mediating role of job satisfaction on the relationship of workplace spirituality and organizational justice on workplace deviance behavior. In *Proceedings of the 2nd International Conference of Business, Accounting and Economics, ICBAE 2020, 5-6 August 2020, Purwokerto, Indonesia*.
- Sarwar, A., Muhammad, L., & Sigala, M. (2021). Unraveling the complex nexus of punitive supervision and deviant work behaviors: findings and implications from hospitality employees in Pakistan. *International Journal of Contemporary Hospitality Management*.
- Schober, P., Boer, C., & Schwarte, L. A. (2018). Correlation Coefficients. *Anesthesia & Analgesia*, 126(5), 1763–1768.
- Shani Pindek, David j, Howard, Alexandra Krajevska, Paul E. Spector. (2019). Organizational constraints and performance.
- Shoss MK, Hunter EM, Penney LM. (2016). Avoiding the issue: Disengagement coping style and the personality -CWB link. *Hum Perform* 29: 106-122.
- Shoss MK, Hunter EM, Penney LM. (2016). Avoiding the issue: Disengagement coping style and the personality -CWB link. *Hum Perform* 29: 106-122.
- Sonnentag, S. and Starzyk, A. (2015). Perceived prosocial impact, perceived situational constraints, and proactive work behavior: Looking at two distinct affective pathways, *Journal of Organizational Behavior*, 36(6), 806-824.
- Sumethokula, P., Patwary, A. K., Srinuanpanc, B., Srinuanpand, C., Suwandee, P., Thammathikul, A., & Phanong, W. (2020). The potential of new tour repackaging for creative tourism among entrepreneurs in Nakhon Si Thammarat. *International Journal of Innovation, Creativity and Change*, 13(10), 1752-1771.
- Ulmer & Steffensmeier. (2014). The Problem of Proverty.

- Wu, B., Liu, S., Wang, J., Tahir, S., & Patwary, A. K. (2021). Assessing the mechanism of energy efficiency and energy poverty alleviation based on environmental regulation policy measures. *Environmental Science and Pollution Research*, 28, 40858-40870.
- Wu, B., Zhai, B., Mu, H., Peng, X., Wang, C., & Patwary, A. K. (2021). Evaluating an economic application of renewable generated hydrogen: A way forward for green economic performance and policy measures. *Environmental Science and Pollution Research*, 1-15.
- Yeşiltaş, M., & Gürlek, M. (2020). Understanding the nature of deviant workplace behaviors. In *Organizational behavior challenges in the tourism industry* (pp. 305-326). IGI Global.



# Customer Satisfaction and Willingness to Use Self-Service Kiosk In Genting Highlands Hotel

Norfitriyah Shakirah Binti Mohamad, Norsyafiqah Binti Suffri, Nur 'Aisyah Binti  
Abdul Razak & Nurashikin Binti a Radzuan\*

*Faculty of Hospitality, Tourism and Wellness of University Malaysia Kelantan, Kota Bharu, Malaysia*

*h20a1411@siswa.umk.edu.my, h20a1419@siswa.umk.edu.my, h20a1424@siswa.umk.edu.my &  
nurashikin.ar@umk.edu.my\**

## ABSTRACT

---

*“The hospitality industry now includes self-service kiosk (SSK) technology. This study attempted to examine how self-service kiosks: ease of use, speed of delivery, and monetary promotion influence customer satisfaction in Genting Highlands hotel. The study also examined the link between customer satisfaction and future self-service kiosk usage intentions. The study's aims to investigate how ease of use, delivery speed, and monetary promotion affect customer satisfaction with SSK. The data was analyzed using descriptive statistics and Pearson correlation analysis. Respondents were given 384 questionnaires. In the study's findings, there was no significant relationship between monetary promotion and customer satisfaction, showing that ease of use and delivery speed influenced customer satisfaction positively. The likelihood of using self-service kiosks in the future was positively connected to customer satisfaction. The study validates the elements required for effective SSK customer satisfaction at the Genting Highlands hotel. It provides significant details on the variables that impact satisfaction.”*

**Keywords:** Hotel Industry, Customer Satisfaction, Ease of Use, Speed of Delivery, Monetary Promotion.

## 1.0 INTRODUCTION

The fastest-growing sector of the global economy is technology in the hotel sector. In Malaysia, it is quickly expanding (Euromonitor International, 2019). Self-service technology (SST) adoption is an unfamiliar experience for its users. The Department of Statistics Malaysia (2019) reports that the number of accommodation facilities increased with a total annual growth rate of 6.7% from RM13.9 billion in 2015 to RM15.8 billion in 2017. Given that it has accelerated change and has business implications in numerous industries, technology is one of the most important forces in the world today (Michelle Evans, 2019). Work is now simpler, more adaptable, and more satisfying for employees thanks to technology (Casado, 2014).

Self-check-in and self-check-out kiosks are uncommon at hotels in Malaysia. The three-star First World Hotel and Plaza, Genting Highland, is one of the incredibly few hotels that uses these kiosks. The goal of this study is to understand how satisfied and eager customers are to use self-service kiosks in Genting Highlands. The study's findings are extremely important given Malaysia's rapid growth in the use of self-service kiosks. This study, however, focuses

on how likely it is for customers to use self-service kiosks in a select number of Genting Highlands locations.

### **Significance of the Study**

According to the study's title, "Customer Satisfaction Towards Self-Service Kiosks in Genting Highlands Hotel," the researcher has examined how changes in the independent variables, which are the factors that determine ease of use, speed of delivery, and monetary promotion of self-service kiosk in Genting Highlands hotel, affect the dependent variable, which is customer satisfaction.

In the present study, the researchers were able to gain a deeper understanding of how the self-service kiosk at the Genting Highlands hotel's ease of use, speed of delivery, and monetary promotion affected customer satisfaction. Additionally, this study gave researchers the opportunity to pinpoint significant, previously studied components that have an impact on the customer satisfaction process. Future researchers might benefit by referring to the study's topic.

The research paper is important to the hotel industry since it gave the sector information on how customers felt about using self-service kiosks at the Genting Highlands hotel. As a result, it will offer a reliable foundation of knowledge that will make evident the relevance of offering great services and their impact on customer satisfaction. Hotels become increasingly prevalent in the market as a result of this factor. The hotel industry gets competitive advantages through better decision-making, which benefits in terms of generating more profit.

Future customers may profit from the research topic because it offered advice on how to thoroughly understand consumer satisfaction when using self-service kiosks at the Genting Highlands hotel. The research that has given prospective customers important data demonstrates the real customer satisfaction of using self-service kiosks at the Genting Highlands hotel.

## **2. LITERATURE REVIEW**

### **2.1 Ease of Use**

According to Yen HR (2005), ease of use relates to both the effort needed to use innovation and the complexity of the method used to provide services. This would apply to both hotel workers and visitors utilizing the software while giving or receiving services inside the property. According to Bilgihan et al. (2016), systems that are simple to use and don't place customers under time constraints will result in a better cognitive experience. In light of this, it is essential for hospitality service providers, especially those working in the hotel sector, to evaluate and consider the value of incorporating SST into their everyday business practises. The ease of use of a system is a sign that a company values, cares for, and comprehends its customers. (Egger and others, 2001) While simplicity of use may improve service delivery for service providers and increase extrinsic advantages for customers, it prevents consumers from interacting with service providers, which may disappoint their desire to do so (Ko, 2017). In contrast, Kim and Qu (2014) assert that perceived use has no impact on consumer satisfaction with SST.

## **2.2 Speed of Delivery**

Speed delivery is a value-added service that refers to the time between an item's replacement and real delivery to the customer's location (Myriam Ertz, 2021). Today's consumers are incredibly demanding when it comes to how quickly services are provided, and they usually underestimate how long it will take. When customers want to make bookings, the responsiveness of the kiosks for delivery is the first impression of hotel service, which today frequently begins online before the guest stay (Mok et al., 2013). Customers are satisfied when service delivery meets or surpasses expectations, according to the service quality hypothesis. However, dissatisfaction happens when the opposite is true and the customer's expectations are higher than what is provided. As a result, they acknowledged SSTs as a practical tool that allows them to save time while producing the least amount of waste. Increased service delivery speed, flexibility, and control are acknowledged as major factors in customers' decisions to use SSTs (Hilton et al. 2013).

## **2.3 Monetary Promotion**

Monetary promotion is a sort of sales promotion that directly influences the price of the product that the buyer pays. According to this study, since self-ordering kiosks and apps are both made available for free, people view them as extra advantages in addition to the benefits of utilizing them. Consumers' usage intentions are greatly influenced by the self-ordering kiosk's free-to-download feature. For instance, by merely emphasizing specific discounts, keyless systems, and rewards, hotels can raise awareness of the self-ordering kiosks used in administration. With these efforts, it will benefit the active promotions for customers, giving them the opportunity to fully utilize the available app. We propose that service excellence can account for the beneficial impact of promotions that are in line with consumers' spending and financial objectives on customer satisfaction (Ratneshwar et al., 2001).

## **2.4 Customer Satisfaction**

According to the hospitality perspective, customer satisfaction as measured by the service may have an impact on their future loyalty to the service provider (RA Rather, 2021). The biggest predictor of a hotel's future profits is how happy its customers are. Khan, S., and N. N. Abdullah (2019). However, in a purchase transaction, consumer contentment in exchange for a specific price is referred to as satisfaction. Additionally, it is essential to measure customer satisfaction in order to establish the discrepancy between expected and actual performance. This is also known as a consumer's judgement of how satisfied they are with the level of consumption-related fulfilment offered by the good or service. In light of what the customer has purchased, consumed, and compared, contentment is defined as a "pleasant reaction" of the consumer (Hamid. R, et al. 2022).

## 2.5 Research Hypotheses

The hypothesis tested are:

H1: There is a significant relationship between ease of use and customer satisfaction towards the hotel industry in Genting Highlands.

H2: There is a significant relationship between speed of delivery and customer satisfaction towards the hotel industry in Genting Highlands.

H3: There is a significant relationship between monetary promotion and customer satisfaction towards the hotel industry in Genting Highlands.

## 2.6 Research Framework

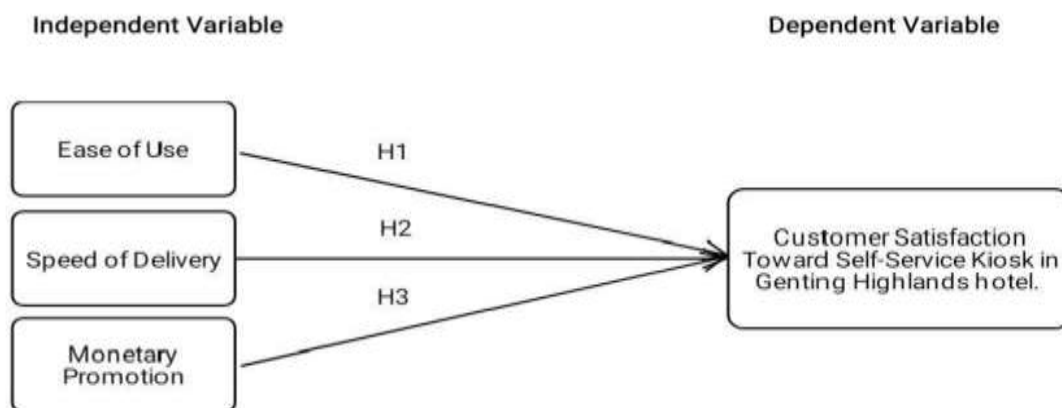

Figure 1: Conceptual Framework

Source: Framework adopted from Chanmi Hong and Lisa Slevitch (2018)

Figure 1 was used by the researcher to establish the relationship between independent variables and dependent variables. Easy of use, quickness of delivery, and financial promotion are the independent variables. Customer satisfaction with the hotel's self-service kiosks in Genting Highlands is the dependent variable. The framework demonstrates that consumer satisfaction with self-service kiosks at Genting Highlands hotel depends on a number of important aspects, including ease of use, delivery timeliness, and financial incentives.

### **3. METHODOLOGY**

#### **Research Design**

The customer who uses the self-service kiosks in the hotels in Genting Highlands will be the focus of the analysis. Rahi (2017) claims that while using survey questionnaires for research, a quantitative method is employed for data collecting, pre-defined instruments, and sample population searching. In order to conduct this study, self-service kiosk users at hotels in Genting Highlands were selected. Descriptive research is used to gather data through questionnaires completed by respondents and then used to characterize the data.

A study design's goal is to provide an explanation of the data collected to help researchers provide a clear response to the original inquiry (Da De Vaus, 2001). Descriptive research can also provide answers to the what, when, who, where, and how of an issue because it typically involves a wider population.

#### **Data Collection**

The researcher employed a questionnaire and secondary data to gather data for this study. Sections A, B, and C make up the three sections that make up the questionnaire. surveys All were given out to guests who had used the self-service kiosks at hotels in Genting Highlands. The questionnaire given to the respondents is multilingual and contains questions in both Malay and English. Before distributing the questionnaire, the researcher first got the target respondent's permission to go around Genting Highlands and gather data. Respondents who work in Genting Highlands hotels with guests who frequently use self-service kiosks received surveys. After the respondent has completed the entire questionnaire, data is gathered. To ensure the accuracy of the data acquired, researchers personally collected the surveys from the respondents.

#### **Sampling**

Purposive sampling was utilised in this study as a sample strategy to gather informational data. This purposive sample is one whose characteristics are predetermined for a particular research objective. C. Andrade (2021). Purposive sampling is used to examine consumer satisfaction with the self-service kiosks in the hotel in Genting Highlands as a reflection of the population. Each region has its own autonomous study locations. Customers who have checked into Genting Highland hotels solely are the research's target group. According to Krejcie and Morgan (1970), the sample size was 384 people, and the population was 1,678,700 people with experience checking into Genting Highlands Hotel.

#### **Data Analysis**

In order to analyses the data gathered for this study, the Statistical Package for Social Science (SPSS), version 26 was used. A programme called SPSS uses statistical statistics and correlation to explain the relationship between independent and dependent variables. The data collected from guests who responded and checked into the Genting Highlands hotel can be transformed into useful information using SPSS.

#### 4. FINDINGS

**Table 1: Demographic Analysis**

Item	Frequency (n)	Percentage (%)
<b>Gender</b>		
<i>Female</i>	229	59.6
<i>Male</i>	155	40.4
<b>Age Group</b>		
<i>18-25 years old</i>	161	41.9
<i>26-35 years old</i>	86	22.4
<i>36-45 years old</i>	98	25.5
<i>46-55 years old</i>	34	8.9
<i>56-65 years old</i>	5	1.3
<b>Level of education</b>		
<i>SPM</i>	41	10.7
<i>STPM/STAM/Diploma</i>	61	15.9
<i>Degree</i>	181	47.1
<i>Master/PhD</i>	49	12.8
<i>Others/Lain-lain</i>	52	13.5
<b>Household Income (per month)</b>		
<i>RM0</i>	111	28.9
<i>&lt; RM1000</i>	57	14.8
<i>RM1500-RM2500</i>	133	34.6
<i>RM3000-RM4500</i>	56	14.6
<i>&gt;RM50000</i>	27	7.0
<b>Race</b>		
<i>Malay</i>	168	43.8
<i>Chinese</i>	71	18.5
<i>Indian</i>	77	20.1
<i>Others</i>	68	17.7
<b>Do You Have Experienced Using An SSK in Genting Highlands Hotel</b>		
<i>Yes</i>	228	59.4
<i>No</i>	156	40.6
<b>Hotel Type</b>		
<i>Luxury</i>	38	9.9
<i>Mid-price</i>	83	21.6
<i>Budget</i>	76	19.8
<i>Not Applicable</i>	31	8.1
<b>Total</b>	<b>384</b>	<b>100</b>

The female gender is the highest than male with 59.6% of those surveyed. The majority are aged between 18-25 years old (41.49%). 47.1% had a bachelor's degree as their minimum qualification and 34.6% has a household income for RM1500-RM2500. Next, 43.8% is Malay. 59.4% of respondents who answered yes for customer have an experienced using Self-Service Kiosks in Genting Highlands hotel. The last one is hotel type is mid-price which is 21.6%

**Table 2: Descriptive Analysis**

Variable	Items	Mean	Standard Deviation
Ease of Use	Using a self-service kiosk for check-in was complicated	2.69	1.112
	Using a self-service kiosk for check-in was confusing	2.77	0.963
	Using a self-service kiosk for check-in took a lot of effort	3.82	1.139
	Using a self-service kiosks for check-in required little work	4.00	1.074
Speed of delivery	Using a self-service kiosk for check-in allowed me to save time during check-in/out	4.76	1.049
	Using a self-service kiosk for check-in made my check-in/out takes a lot of time to check-in or check-out in the room hotel	3.46	1.500
Monetary Promotion	Self-service kiosk's monetary promotion were attractive	4.19	0.992
	Self-service kiosk's monetary promotion like coupons or promotional deals caused me to use an self-service kiosks	3.94	0.856
Customer Satisfaction	My choice to use a particular self-service kiosk for check-in/out was a wise one	4.72	0.988
	I was happy with the usage of the self-service in that particular instance	4.58	0.901
	Overall, I was satisfied with using the hotel self-service kiosk	4.68	0.939

### Reliability Analysis

The results of the reliability analysis for the study variables were shown in the table. The data indicates that Customer Satisfaction towards self-service kiosks in Genting Highlands hotel is 0.816 (Dependent Variable), Speed of Delivery is 0.397, Monetary Promotion is 0.764, and Ease of Use is 0.627. Additionally, all of the Independent Variable items—Ease of Use, Speed of Delivery, and Monetary Promotion—were acceptable; however, only Speed of Delivery is unacceptable because the results for H1 and H2 were over 0.6 while H3 did not yield a score. Customer satisfaction with the hotel's self-service kiosks, the dependent variable, has a value of 0.816, indicating that the variables used were adequate and accurate in assessing this variable. In summary, Cronbach's Alpha reliability coefficients for the study's independent variables were satisfactory and correlated with one another; the only variable that wasn't correlated with another was delivery speed.

**Table 3: Cronbach's Alpha**

No of items	Study variable	Cronbach's Alpha	Remarks (acceptable/not acceptable)
4	Ease of Use	0.627	Acceptable
2	Speed of Delivery	0.397	Not Acceptable
2	Monetary Promotion	0.764	Acceptable
3	Customer Satisfaction	0.816	Acceptable

Pearson's Correlation

**Table 4: Correlations between Ease of Use and Customer Satisfaction towards self-service kiosks in Genting Highlands hotel**

Correlations			
		Ease Of Use	Customer Satisfaction
Ease Of Use	Pearson Correlation	1	.009
	Sig. (2-tailed)		.896
	N	228	228
Customer Satisfaction	Pearson Correlation	.009	1
	Sig. (2-tailed)	.896	
	N	228	228

Based on finding, Table 4 show that positive value of correlation coefficient is .009 which is indicates that the relationship between ease of use and customer satisfaction is positively negligible.

H1: There is significant relationship between ease of use and customer satisfaction towards self-service kiosks in Genting Highlands hotel.

**Table 5: Correlations between Speed of Delivery and Customer Satisfaction towards self-service kiosks in Genting Highlands hotel**

Correlations			
		Speed of Delivery	Customer Satisfaction
Speed of delivery	Pearson Correlation	1	.354**
	Sig. (2-tailed)		.000
	N	228	228
Customer Satisfaction	Pearson Correlation	.354**	1
	Sig. (2-tailed)	.000	
	N	228	228

\*\* . Correlation is significant at the 0.01 level (2-tailed).



Based on the finding on Table 5, it shows that positive value of correlation coefficient is .354\*\* which indicates that the relationship between speed of delivery and customer satisfaction is positively weak. Therefore, speed of delivery has a weak relationship in determining customer satisfaction towards self-service kiosks in Genting Highlands hotel. H2: There is significant relationship between speed of delivery and customer satisfaction towards self-service kiosks in Genting Highlands hotel.

**Table 6: Correlations between Speed of Delivery and Customer Satisfaction towards self-service kiosks in Genting Highlands hotel**

Correlations			
		Monetary Promotion	Customer Satisfaction
Monetary Promotion	Pearson Correlation	1	.348**
	Sig. (2-tailed)		.000
	N	228	228
Customer Satisfaction	Pearson Correlation	.348**	1
	Sig. (2-tailed)	.000	
	N	228	228
**. Correlation is significant at the 0.01 level (2-tailed).			

Based on the finding on Table 5, it shows that positive value of correlation coefficient is .348\*\* which indicates that the relationship between monetary promotion and customer satisfaction is positively weak. Therefore, monetary promotion has a weak relationship in determining customer satisfaction towards self-service kiosks in Genting Highlands hotel. H3: There is significant relationship between monetary promotion and customer satisfaction towards self-service kiosks in Genting Highlands hotel.

## **5. DISCUSSION & RECOMMENDATION**

As a result, the study's conclusions may not necessarily represent the entire population, particularly Malaysian hotel customers. To successfully achieve the research objectives, a 6-point Likert scale was used in this study. The data discovered for monetary promotion and customer satisfaction signal positive significant results since the level of reliability from Cronbach's Alpha exceeds the amount than 0.7, which implies that monetary promotion was the most prominent element in this study. In contrast, the reliability test for ease of use and speed of delivery was unable to obtain a positive result, it was significantly lower than 0.7. As a result, ease of use and speed of delivery are not the variables with the greatest impact in customer satisfaction.

### **Implication of The Study**

First and foremost, this research study provided all the essential information that a new researcher or new businessperson interested in this topic could possibly need, particularly regarding how the ease of use, speed of delivery, and ease of use affect customers' satisfaction with self-service kiosks in the Genting Highlands hotel. With the use of this information, the researcher will look into the variables influencing patron satisfaction with self-service kiosk check-in and check-out at local hotel Genting Highlands. The new researcher was also able to pinpoint significant, little-studied characteristics that may influence whether or not hotel guests use self-service kiosks for check-in and check-out.

Second, this study is advantageous to the hotel sector since it sheds light on the factors that influence customer satisfaction towards the self-service kiosks in Genting Highlands hotel. Hotel operators can determine if customers plan to better use self-service kiosks in hotels by adjusting to their expectations for the factors of ease of use, speed of delivery and monetary promotion. In order to properly satisfy the customer's desire, hotel industry managers should do in-depth research into customer satisfaction for returning, especially for those who do so frequently. Thus, a kiosk can make a major impact in how the hotelier handles their customers and how their customers use services. It provides the hotelier with a reasonable opportunity to enhance hotel revenue through upsells and elevate their guest experience in the hotel industry.

Thirdly, future customers who plan to use self-service kiosks check-in and checkout at hotels in Genting Highlands will benefit from the examination of these findings. This study could help broaden our understanding and tell potential customers about the variables that lead to a desire to use the technology right now. By outlining the factors that should be taken into account when customers decide to choose the kiosks technology to check-in and checkout services at a hotel, this study helps readers understand which factors led the kiosks technology to integrate it into service producers especially in the hotel industry.

### **Recommendation**

This study employs a purposive sample and quantitative technique, which allows the researcher to find and maximize the number of respondents who respond determined by the questionnaire they accomplish. To accurately assess each acquired data set, the reviewer will consistently keep up and track rightfully on every occasion.

In this study, the researchers focused only on three variables that can affect Genting Highlands Hotel guests' satisfaction with self-service kiosks. However, there may be additional important factors that influence how a researcher determines if customers are satisfied with the self-service kiosks in the Genting Highlands hotel. Therefore, it is advised that future researchers conduct more research into additional factors including time management, machine facility, and machine speed while employing with the aim of enhancing the study's findings, which truly affect customer happiness.

Furthermore, further research should take consideration of the survey respondents' experiences, as customers in Malaysia may have varied experiences when utilising self-service kiosk machines due to different demographic characteristics. It can assist future researchers understand the pattern of occurrence of customer satisfaction with self-service kiosks at Genting Highlands hotel.

## **6. CONCLUSION**

This chapter's conclusion looked at the key findings of the customer satisfaction survey conducted at the Genting Highlands Hotel. The examination of 385 complete questionnaires revealed that the study's goals were met, its questions were answered, and its hypotheses were confirmed as reasonable. Overall, there is a strong favorable relationship between financial advertising and client satisfaction. However, because it falls short of 0.7, the association between ease of use and delivery speed is weak, demonstrating that Genting Highlands Hotel's financial promotion plays a significant role in the significance of customer satisfaction.

## REFERENCES

- Akter, M., Sadekin, M. N., & Patwary, A. K. (2020). An Empirical Study on Students' Satisfaction from Mawlana Bhashani Science & Technology University, Bangladesh. *Review of Economics and Development Studies*, 6(2), 363-379.
- Alom, S., Patwary, A. K., & Khan, M. M. H. (2019). Factors affecting the turnover intention of Bangladeshi migrants in the United Arab Emirates: An empirical study on the hotel industry. *International Journal of Innovation, Creativity and Change*, 8(3), 344-360.
- Andrade, C. (2021). The inconvenient truth about convenience and purposive samples. *Indian Journal of Psychological Medicine*, 43(1), 86-88.
- Bilgihan, A. and Wang, Y. (2016), "Technology induced competitive advantage: a case of US lodging industry", *Journal of Hospitality and Tourism Technology*.
- Casado, M.A. (2014), *Front Office Management in Hospitality Lodging Operations*, Create Space Independent Publishing, USA.
- Dabholkar P. (1996). Consumer evaluations of new technology-based self-service options: an investigation of alternative models of service quality. *Int J Res Mark* 13(1):29–51.
- Egger, G., Donovan, R.J., Billie, G-C, Fiona, B., & Swinburn, B. (2001) 'Developing national physical activity guidelines for Australians', *Australan and New Zealand Journal of Health*.
- Euromonitor International. (2019). Consumer Foodservice Global Industry Overview. Retrieved from <https://www.euromonitor.com/consumer-foodservice-globalindustry-overview/report>
- Fengmin, Z., Baijun, W., Jiangtao, B., Li, L., & Patwary, A. K. (2022). Investigating revisit intention of medical tourists in China through nutritional knowledge, perceived medical quality, and trust in the physiologist: A recommendation on health tourism policy measures. *Frontiers in Public Health*, 10, 893497.
- Hamid, R., Ong, M. H. A., & Kusumah, G. (2022). Investigating the Effect of Satisfaction toward Self-Service Technology (SST) and Behavioral Intention Relationship: Its role in the green hotel industry. *Environment-Behaviour Proceedings Journal*, 7(21), 285-291.
- Hazbar, A. M. H., Alem Mohammed, A., & Karim, A. K. A. (2019). An Empirical Study of Factors Influencing hotel customers' online booking Intention. *مجلة العلوم التربوية و الدراسات الإنسانية*, 5(5), 1-17.
- Hilton T, Hughes T, Little E, Marandi E. (2013) Adopting self-service technology to do more with less. *Journal of Services Marketing*.
- Hong, C., & Slevitch, L. (2018). Determinants of Customer Satisfaction and Willingness to Use Self-Service Kiosks in the Hotel Industry. *Journal of Tourism & Hospitality*.
- Khan, S., & Abdullah, N. N. (2019). The effect of ATM service quality on customer's satisfaction and loyalty: an empirical analysis. *Russian Journal of Agricultural and Socio-Economic Sciences*, 89(5), 227-235.
- Kim, M. and Qu, H. (2014), "Travelers' behavioral intention toward hotel self-service kiosks usage", *International Journal of Contemporary Hospitality Management*,
- Ko, C. H. (2017). Exploring how hotel guests choose self-service technologies over service staff. *International Journal of Organizational Innovation*.
- Krejcie, R. V., & Morgan, D. W. (1970). Determining sample size for research activities. *Educational and psychological measurement*, 30(3), 607-610.
- Li, L., Ragavan, N. A., Patwary, A. K., & Baijun, W. (2022). Measuring patients' satisfaction toward health tourism in Malaysia through hospital environment, nutritional advice, and perceived value: A study on Chinese exchange students. *Frontiers in public health*, 10, 893439.

- Li, L., Wu, B., & Patwary, A. K. (2022). How marine tourism promote financial development in sustainable economy: new evidences from South Asia and implications to future tourism students. *Environmental Science and Pollution Research*, 29, 1155-1172.
- Li, L., Wu, B., & Patwary, A. K. (2022). The psychosocial factors affecting chinese Outbound Exchange and mobility students' academic performance during COVID-19. *Frontiers in psychology*, 13, 872516.
- Mohammad, A.A., Rashid, B. and Tahir, S. (2013), "Assessing the influence of customer relationship management (CRM) dimensions on organization performance: An empirical study in the hotel industry", *Journal of Hospitality and Tourism Technology*, Vol. 4 No. 3, pp. 228-247.
- Myriam Ertz (2021). <https://www.igi.global.com/book/handbook-research-platformeconomy-evolution>
- Patwary, A. K., Roy, B., Hoque, R., & Khandakar, M. S. A. (2019). Process of developing a community based tourism and identifying its economic and social impacts: An Empirical study on Cox's Bazar, Bangladesh. *Pakistan Journal of Humanities and Social Sciences*, 7(1), 1-13.
- Rahi, S. (2017). Research Design and Methods: A Systematic Review of Research Paradigms, Sampling Issues and Instruments Development. *International Journal of Economics & Management Sciences* 6(2): 1-5.
- Rather, R. A., & Hollebeek, L. D. (2021). Customers' service-related engagement, experience, and behavioral intent: Moderating role of age. *Journal of Retailing and Consumer Services*, 60, 102453.
- Ratneshwar, S., Barsalou, L.W., Pechmann, C. and Moore, M. (2001), "Goal-derived categories: the role of personal and situational goals in category representations", *Journal of Consumer Psychology*.
- Sumethokula, P., Patwary, A. K., Srinuanpanc, B., Srinuanpand, C., Suwandee, P., Thammathikul, A., & Phanong, W. (2020). The potential of new tour repackaging for creative tourism among entrepreneurs in Nakhon Si Thammarat. *International Journal of Innovation, Creativity and Change*, 13(10), 1752-1771.
- Weijters, B., Rangarajan, D., Falk, T., & Schillewaert, N. (2007). Determinants and Outcomes of Customers' Use of Self-Service Technology in a Retail Setting. *Journal of Service Research*, 10(1), 3–21.
- Wu, B., Liu, S., Wang, J., Tahir, S., & Patwary, A. K. (2021). Assessing the mechanism of energy efficiency and energy poverty alleviation based on environmental regulation policy measures. *Environmental Science and Pollution Research*, 28, 40858-40870.
- Wu, B., Zhai, B., Mu, H., Peng, X., Wang, C., & Patwary, A. K. (2021). Evaluating an economic application of renewable generated hydrogen: A way forward for green economic performance and policy measures. *Environmental Science and Pollution Research*, 1-15.

# The Influences of Hygiene Attributes Toward Customers' Fear of Covid at Thai Restaurant in Kota Bharu, Kelantan.

Nur A'ina Sofia Binti Sufhian, Nur A'watief Binti Mohd Nawi, Nur Afeeqa Ilani Binti Norazuki & Nurashikin Binti A Ridzuan\*

*Faculty Hospitality, Tourism and Wellness of Universiti Malaysia Kelantan*

[h20a1426@siswa.umk.edu.my](mailto:h20a1426@siswa.umk.edu.my), [h20a1427@siswa.umk.edu.my](mailto:h20a1427@siswa.umk.edu.my), [h20a1433@siswa.umk.edu.my](mailto:h20a1433@siswa.umk.edu.my) & [nurashikin.ar@umk.edu.my](mailto:nurashikin.ar@umk.edu.my)\*

## ABSTRACT

---

*In Malaysia, the impact of COVID-19 had put management in the business industry under pressure. The prolonged spread of the coronavirus had caused business in Malaysia to not grow. This study combined the characteristics of restaurant hygiene such as hygiene of customer-use, personal hygiene of staff and hygiene of workspaces. The purpose of this study was because not many studies had been conducted to investigate the perception of risk in doing business following the health crisis and customers' fear of the virus. Therefore, this study was designed to examine the influence of cleanliness on customers' fear of COVID-19 on businesses in Malaysia. This study had been a questionnaire as a method to collect data and it would be analyzed using SPSS. This study was believed to give good insight to academics and practitioners in preparing them for the post-corona field for the new normal after the limited life experience during the unprecedented epidemic.*

### **Keywords :**

*Hygiene attributes, Fear of COVID-19*

---

## 1. INTRODUCTION

The COVID-19 pandemic was initially identified in mid-December 2019, with the first case reported in Wuhan, China (Wang et al., 2020 & Yuki et al., 2020). The COVID-19 virus is an infectious disease caused by the SARS-CoV-2 virus (Shereen et al., 2020). This virus can cause infections such as cough, fever, cold, lung infection and shortness of breath that can cause death (Boyras et al., 2020). Anyone infected with COVID-19 can spread it to others, even if the infected person has no symptoms (Katella, 2022). This outbreak of COVID-19 can be classified as a pandemic because this epidemic has spread massively and rapidly throughout the world (Cucinotta et al., 2020). COVID-19 is a highly contagious and pathogenic viral infection produced by the severe acute respiratory SARS-CoV-2 virus, which caused a global pandemic and a significant loss of human life globally (Sheree et al., 2020).

Restaurants are one of the industries dealing with various issues related to COVID-19 and there is no denying that the COVID-19 pandemic is affecting almost all F&B businesses. The recent global COVID-19 epidemic has had a considerable influence on the restaurant business (Gossling et al., 2020). This industry's high vulnerability to the outbreak has been universally recopredignised as a result of the worry that it creates in customers about social

exception (Gossling et al., 2020). Restaurant owners feel it is vital to provide measures for client safety and security to encourage repeat business since customers' regular visits to restaurants may be threatened by potential exposure to COVID-19 dangers (Sharma A. et al., 2020). However, if customer worries regarding the potential of COVID-19 grow, major changes in customer behavioral intentions are predicted. Because it directly affects restaurant operations, customer retention is important for restaurant success (Yan et al., 2015). In this context, it is necessary to investigate the variables that affect repeat restaurant customer intentions in context of the developing situation due to COVID-19.

Unhygiene customer-use can make customers afraid to visit the restaurant. Customers are worried about whether the facilities or equipment provided are in a clean condition or not. This is because the COVID-19 virus can easily spread even if it is only through contact. According to (Delea et al., 2020; Yu et al., 2021b), customer interaction can be direct or indirect. Moreover, the COVID-19 virus can also spread through personal hygiene of staff. This is because, they are among the groups that communicate a lot with customers. The spread of the Covid-19 epidemic between staff and customers, whether directly or indirectly, has the potential to increase viral infections, according to (Boyras et al., 2020). The way workers do not follow SOP such as not wearing a face mask and wearing dirty clothes can be one of the factors to spread viral infections. In addition, the problem of contagion of COVID-19 can also occur when hygiene at the workplace is not clean. It is well known that the COVID-19 virus can spread through the air. According to Jamaludin, when the environment is not clean, the restaurant staff become uncomfortable and afraid to go to work because they are worried if they get infected with this virus. This situation not only creates fear in employees but it also creates fear in customers to visit the restaurant.

### **1.1 Significance of The Study**

In this research article, it helps researchers to find out how the quality of environmental cleanliness and service influences customers and customers to revisit the restaurant. Additionally, this research enables researchers to identify favorable features that also have a good impact on restaurant management and customer satisfaction with the hygiene of the restaurants during the COVID-19 outbreak. The title of this study may provide future scholars with an idea. Future customers may benefit through the research topic because the research provides guidance to fully understand the relationship between hygiene that needs to be taken care of especially in running a business such as food which is also where it should be acted to all restaurant owners about hygiene that has been made. This research paper is important to customer health and insight to the food and beverage industry where customers can learn about the cleanliness and quality of workers during the COVID-19 outbreak.

## **2. LITERATURE REVIEW**

### **2.1 Personal Hygiene of Staff**

According to Munguti (2022), personal hygiene involves cleanliness of the body and clothes, healthy eating, proper living habits, exercise and rest. Good personal hygiene means keeping all parts of the physical body clean and healthy. It is an important part of mental health and maintaining physical. Ford mentioned that personal hygiene is a personal care routine to ensure that one's whole body is clean, fresh, and healthy. One of the most effective ways to protect against infectious diseases is to have good personal hygiene such as frequent hand washing, showering, and using protection such as wearing gloves. For people with poor personal hygiene, this may leave a person exposed to germs and viruses (Ames, 2020).

In closed environments like hotels, aeroplanes, and restaurants, there will inevitably be employee-customer interaction, whether direct or indirect (Yu et al., 2021a). Infectious infections are more likely to be caught and disseminated due to the nature of interactions with customers and handling their belongings (Zhang et al., 2020).

### **2.2 Hygiene of Customer-use**

According to Humanitarian Global (2021), the term "hygiene" is derived from the Greek word "hygieinos," which meaning healthy or everything connected to health and cleanliness. Generally, the term hygiene is used to indicate 'the act of maintaining personal hygiene and environmental conditions, especially to avoid disease or the spread of infectious disease outbreaks. Many infectious infections, including the COVID-19 virus, can be avoided by maintaining good hygiene. It is essential for achieving greater health and well-being. The World Health Organisation (WHO) defines hygiene as the conditions and practises that support maintaining health and preventing the spread of disease.

A customer is an individual or business that buys goods or services from a business or company. Customers are important because they drive the country's income. Without them, the business cannot continue to thrive and grow. All businesses compete with other companies to attract customers, either by aggressively advertising their products, by lowering prices to expand their customer base, or by developing unique products and experiences that customers love.

### **2.3 Hygiene of Workspace**

According to Hung et al. (2018), a restaurant's workstation that isn't hygienic can contribute to the spread of infectious diseases and raise customer anxiety. In order to stop this pandemic from spreading and draw consumers to the restaurant, the work environment must be kept clean. When regular cleaning and sanitation are performed to stop the spread of epidemics in every location made available to consumers, the cleanliness of the workplace may be maintained.

Customers believe that the degree of cleanliness of the workspace is vital in lowering the likelihood of the virus infection from spreading further in the wake of the COVID-19 epidemic. Customers will harbor reservations about a workspace that is not perfectly cleaned, per (Park et al., 2019).



## **2.4 Customers' Fear of COVID-19.**

Customer behaviour during COVID-19 is affected by fear, anxiety, lockdown, stocking, panic buying, stress due to loss of control, loss of personal freedom, hygiene measures, spending patterns, routine changes, and earning capacity (Kavya Satish et al., 2021). Fear is a very strong emotion in a person which is often triggered by a perceived threat and it can make a person feel afraid, anxious or panic (Jenkins P., 2022). According to Fritscher (2022), fear is also said to be a symptom of several conditions such as mental health problems including social anxiety, phobias, panic disorder, and post-traumatic stress disorder (PTSD).

Schimmenti A., et al. (2020) believes that fear is a basic emotion that arises in reaction to a perceived threat. The psychological organisation of the three concerns related to the COVID-19 pandemic revolves around four interconnected dialectical domains. dread of the body is the first type of dread, followed by fear of significant people or fear of important people, fear of not knowing or fear of knowing, fear of taking action or fear of inaction, and fear of key people. However, it depends on the interpersonal, cognitive, and behavioural aspects of fear. The four fear categories identified during the COVID-19 epidemic reflect important psychological perspectives on reality.

## **2.5 The Relationship Between Personal Hygiene of Staff, Hygiene of Customer-use, Hygiene of Workspace With Consumers' Fear of COVID-19.**

The relationship between personal hygiene of customers uses with consumers' fear of covid19. Customers typically think that visiting establishments, interacting with staff, and eating at restaurants is risk-free and secure (Choi et al., 2010). However, it has recently been noted (Delea et al., 2020; Yu et al., 2021b) that customer encounters, whether direct (such as a service encounter or shaking hands) or indirect (such as using a room at a restaurant), tend to increase the risk of infection. The restaurant cleanliness practices, hygiene issues, and strict SOP processes, according to (Peng and Chen, 2021), would make the COVID-19 scenario worse.

The relationship between personal hygiene of staff and consumers' fear of covid-19. Employees may be more susceptible to contract and spread infectious diseases due to the way they contact consumers and handle their belongings (Zhang et al., 2020). Yu et al. (2021a) assert that staff will inevitably have direct or indirect contact with clients, particularly in service-related industries like hotels, airlines, and restaurants. Additionally, undercooked food, contaminated equipment, incorrect storage temperature, hazardous food sources, and inadequate personal hygiene are listed as the top five causes of food safety problems in food service establishments by FDA (2017). Customers are more likely to dread COVID-19 if restaurant employees maintain poor personal cleanliness, according to research.

And the relationship between hygiene of workspace and consumers fears of covid-19. according to (WHO, 2020b), has raised awareness of restaurant cleanliness. Because of this, restaurant owners only clean the kitchen area when there are illness outbreaks (Sifuentes et al., 2014). The author understood that filthy eateries with plenty of germs can serve as a cause of infection, according to (Park et al., 2019). Customers choose restaurants that offer indoor and outside service and follow regular sanitation and cleanliness procedures, per the research

described above. But infrequent hygiene inspections can make people worried about the COVID-19 epidemic.

## 2.6 Research Hypothesis

A hypothesis must be testable and realistic, taking current knowledge and methodologies into account. Furthermore, a hypothesis is a forecast or explanation of a link between two variables. It suggests that an independent variable and a dependent variable have a systematic connection. As a result, the research suggests:

H1: There is a favorable correlation between patrons' use of restaurant cleanliness and their concern for COVID-19.

H2: Restaurant patrons' concern of COVID-19 is positively connected with restaurant staff members' personal hygiene.

H3: Restaurant workplace hygiene is positively correlated with customers' fear of COVID-19.

## 2.7 Conceptual Framework

The conceptual framework for this research is seen in Figure 2.1. The three factors that make up the independent variable that will be proposed are hygiene of customers use, hygiene of workspace, and personal hygiene of staff. Consumers' fear of covid-19 is the dependent variable.

Figure 1: Conceptual Framework of the relationship between independent variable and dependent variable

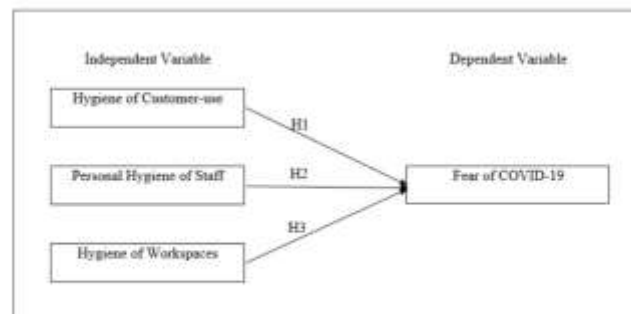

Source : Adopted from Siddiqi et. al., (2022)

### **3. METHODOLOGY**

#### **3.1 Research Design**

The strategy for responding to the research question can be referred to as the study design. It covers the examination of numerical data using particular statistical approaches in order to respond to questions like who, how much, where, what, how many, and how many. Science, social science, and numerous other fields all place a high priority on research design (Abutabenjeh et. al, 2018). All of the data will be collected for this study using a quantitative approach and questionnaires. Quantitative research is a systematic way to collect and analyse data from multiple sources (SIS International, 2018). Making predictions, determining patterns and averages, testing causal theories, expanding results to larger populations, and determining patterns and averages are all possible with it (Bhandari, 2021).

The purpose of this study is to determine the influences of restaurant hygiene attributes toward customers' fear of COVID-19. The data will then be collected using questionnaires given to respondents as part of descriptive research, which may then be used to explain the data.

The aim of a study design is to ensure that the evidence obtained from the data can address the research question. Therefore, descriptive research would be able to address the questions of who, what, when, where and how, when it comes to a certain issue or situation. A sort of study called descriptive research seeks to give the most precise account of phenomena that already exist (Atmowardoyo, 2018).

#### **3.2 Data Collection**

An online survey was used to collect data in order to decrease in-person interaction and keep to social distance standards. As a result, researchergathered data online using platforms like Google Form, a trusted survey tool for social sciences. Respondents were given a brief explanation of the research, the way the data was collected, and the legally essential data protection information. So, over the 20 days, 384 replies were gathered. Researcher used a total sample size of 379 replies after excluding 5 responses that were unsuitable for data processing.

#### **3.3 Sampling**

Researcher choose convenience sampling to conduct research. It is a sampling method that can get information easily, quickly and effectively. This simple sampling is always used in the exploratory phase of a study or when the researcher needs a sample immediately or in the near future.

Based on the population estimate of the Department of Statistics Malaysia (in 2022), Kota Bharu has the largest population of 1,536,516 people or 89% of the 1,720,694 total population of Kelantan. Therefore, this simple sampling method is very useful in this research because the high number of the population gives us the potential to get enough respondents.

### 3.4 Data Analysis

Researcher examined the data using IBM SPSS 26.0 in order to verify the correlations in the suggested hypotheses. Researcher used the following quantitative analytic methods, such as variance inflation factor (VIF), common method variance estimation, structural model assessment, measurement model assessment, and structural model assessment. Researcher also determined the effect size and variation of natural factors.

## 4. FINDINGS

**Table 1:**  
**Demographic Analysis**

<b>Respondent Profile</b>	<b>Frequency n = 379</b>	<b>Percentage (%)</b>
<b>Gender</b>		
Male	149	39.3
Female	230	60.7
<b>Age</b>		
18 – 23	135	35.6
24 – 29	105	27.7
30 – 35	45	11.9
36 – 41	30	7.7
42 and above	64	16.9
<b>Races</b>		
Chinese	48	12.7
Indian	50	13.2
Malay	280	73.9
Other	1	0.3
<b>Frequency of visiting Thai restaurant in a week</b>		
1 – 2	263	69.4
3 – 4	88	23.3
5 – 6	17	4.5
Everyday	11	2.9

This study had collected data from 379 respondents who answered this questionnaire. Table 1 had shown that there were more female respondents than male respondents, with 230 female respondents or 60.7%, while 149 male respondents or 39.3%.

Next, Table 1 also showed the age range of the 379 respondents who answered this questionnaire. The higher respondent age group that answered this questionnaire were respondents aged between 18 and 23 years old which was 135 people or equivalent to 35.6%. The second highest age group of respondents were respondents aged 24 to 29 years old or equivalent to 27.7%. The third highest age group of respondents was respondents aged 42 and over, which was a total of 105 people or equivalent to 16.9%, followed by respondents aged 30 to 35 years which was a total of 45 people or equivalent to 11.9%. Meanwhile, the lowest age range of respondents who answered this questionnaire were respondents aged 36 to 41 years, of which the number of respondents was only 30 people or equal to 7.7%.

Not only that, Table 1 also showed the race category through data obtained from 379 respondents. Out of that number, the majority of respondents who answered this questionnaire were Malay respondents, that was 280 people (73.9%). The second highest race was Indian respondents, which was 50 people (13.2%). Meanwhile, there were 48 Chinese respondents (12.7%). However, there was also one respondent (0.3%) who was of another nationality, the data obtained showed that the respondent was of Siamese nationality.

Lastly, Table 1 showed the frequency of 379 respondents who visit a Thai restaurant in a week. Out of that number, 263 respondents (69.4%) visit Thai restaurants only between 1 to 2 times a week, followed by 88 respondents (23.2%) who visit Thai restaurants 3 to 4 times a week. A total of 17 respondents (4.5%) who visit Thai restaurants 5 to 6 times a week. Meanwhile, only 11 respondents (2.9%) visit Thai restaurants every day in a week.

**Table 2 :**  
**Descriptive Analysis**

Section	Dimension	N	Mean	SD
B	Customers' Fear of COVID-19	375	3.5062	1.1644
C	Hygiene of Customer-use	375	3.6653	1.0130
	Personal Hygiene of Staff	375	3.7370	0.9978
	Hygiene of Workspaces	375	3.6500	0.9655

The mean score for all the three independent variables which were hygiene of customer-use, personal hygiene of staff and hygiene of workspaces 3.6653 (SD = 0.130), 3.7370 (SD = 0.9978) and 3.6500 (SD = 0.9655) respectively. The mean score for dependent variable, customers' fear of COVID-19 score was 3.5062 (SD = 1.1644).

**Table 3 :**  
**Reliability Analysis**

Section	Dimension	Cronbach's Alpha	Number of Items
Dependent Variable	Customers' fear of COVID-19	0.919	5
Independent Variable	Hygiene of customer-use	0.848	3
	Personal hygiene of staff	0.885	3
	Hygiene of workspaces	0.861	3

*N of respondents (n) = 379*

Table 3 shows the reliability of the analysis for all variables that include dependent variables and independent variables. Cronbach's alpha coefficient value for customer fear of COVID-19 is 0.919. The value shows that the reliability of this dependent variable is at an excellent level. Meanwhile, all independent variables show reliability at a good level. Cronbach's alpha coefficient value for hygiene of customer-use is 0.848, personal hygiene of staff is 0.885 and hygiene of workspaces is 0.861.

**Table 4 :**  
**Pearson Correlation Coefficient**

		<b>IV1</b>	<b>IV2</b>	<b>IV3</b>	<b>DV</b>
<b>IV1</b>	<b>Pearson Correlation</b>	1	.725**	.675**	.041
	<b>Sig. (2-tailed)</b>		.000	.000	.427
	<b>N</b>	379	379	379	379
<b>IV2</b>	<b>Pearson Correlation</b>	.725**	1	.765**	.067
	<b>Sig. (2-tailed)</b>	.000		.000	.191
	<b>N</b>	379	379	379	379
<b>IV3</b>	<b>Pearson Correlation</b>	.675**	.765**	1	.077
	<b>Sig. (2-tailed)</b>	.000	.000		.132
	<b>N</b>	379	379	379	379
<b>DV</b>	<b>Pearson Correlation</b>	.041	.067	.077	1
	<b>Sig. (2-tailed)</b>	.427	.191	.132	
	<b>N</b>	379	379	379	379

\*\* . Correlation is significant at the 0.01 level (2-tailed).

Table 4 shows a positive (r) value of 0.041 which showed that the relationship between hygiene of customer-use and customers' fear of COVID-19 was at a positive level of correlation that could be ignored. Therefore, hygiene of customer-use had a correlation relationship that could be ignored in determining customers' fear of COVID-19 at a Thai restaurant in Kota Bharu, Kelantan. Meanwhile, the significant level (p) for this variable was 0.427 which was more than 0.10. In conclusion, hypothesis H1 stated that there was no relationship between hygiene of customer-use and customers' fear of COVID-19 was considered insignificant and it was considered a null hypothesis.

The relationship between personal hygiene of staff and customers' fear of COVID-19 showed a positive value of 0.067 which indicated that was at a positive level of correlation that could be ignored. Therefore, personal hygiene of staff had a negligible correlation in determining the customer's fear of COVID-19 at a Thai restaurant in Kota Bharu, Kelantan. Meanwhile, the significant level of this variable was 0.191 which was more than 0.10. In conclusion, hypothesis H2 stated that there was no relationship between personal hygiene of staff and customers' fear of COVID-19 was considered insignificant and it was considered a null hypothesis.

The relationship between hygiene of workspaces and customers' fear of COVID-19 showed a positive value of 0.077 which indicated that was at a positive level of correlation that could be ignored. Therefore, the hygiene of workspaces had a negligible correlation in determining the customer's fear of COVID-19 at a Thai restaurant in Kota Bharu, Kelantan. Meanwhile, the significant level of this variable was 0.132 which was more than 0.10. In conclusion,

hypothesis H3 stated that there was no relationship between hygiene of workspaces and customers' fear of COVID-19 was considered insignificant and it was considered a null hypothesis.

## **5. DISCUSSION & RECOMMENDATIONS**

Since the COVID-19 pandemic, many industries had prioritized cleanliness, particularly in dining rooms and food equipment. Customers believed that food handlers prioritized sanitizing their equipment daily. However, closed spaces in service industries like restaurants, hotels, and airlines increased the risk of acquiring and spreading infectious diseases. The Malaysian government had introduced a vaccine to prevent the virus from worsening, and food operators must also take typhoid injections. The temporary closure of premises had caused significant losses for the food and beverage industry, highlighting the importance of hygiene in all aspects of the workplace. Customers trusted food operators to take initiative to prevent the spread of the epidemic and attract customers.

### **5.1 Implication of The Study**

This research study explores the impact of restaurant hygiene on customers' fear of COVID-19 at Thai restaurants in Kota Bharu. The study aims to investigate the factors influencing customers' fear of COVID-19 and provide insights for future research. The study highlights the negative impact of unsatisfactory cleanliness on customers' decision to visit Thai restaurants, particularly in areas like the dining room, prayer room, food equipment, and kitchen. Improving cleanliness in these areas can help customers feel less afraid of the virus and encourage them to visit Thai restaurants with confidence. The findings can help potential customers in Kota Bharu by easing their fears about visiting Thai restaurants due to their high level of cleanliness.

### **5.2 Recommendations of The Study**

Future studies should consider educating staff about personal and hand hygiene standards, glove use, proper work clothes, hair and jewelry, and sick leave policies. Maintaining good hand hygiene is crucial for reducing the risk of foodborne illness outbreaks. However, restaurants still have low compliance rates with FDA hand hygiene standards. Future studies on the association between customer usage and COVID-19 should use hygiene of customer use as an independent variable. Quantitative techniques were used to collect data from respondents, allowing for more efficient and targeted responses.

This research can help the food preparation service industry improve operations and productivity, allowing entrepreneurs to retain existing customers and attract new ones. Additionally, developing a restaurant hygiene checklist can help maintain hygiene standards and improve the overall cleanliness of the restaurant.

## 6. CONCLUSION

The present study outlined its shortcomings and provided recommendations for further research. The researcher's sample was only restricted to people of Kelantan, particularly in Kota Bharu, but it would be possible for future researchers to broaden the investigation into restaurant hygiene and customers' concern of COVID-19 in other states. The study also only examined restaurant cleanliness during the COVID-19 pandemic, but subsequent studies could assess the situation even after COVID-19. In conclusion, the broad COVID-19 outbreak may affect diners' capacity to frequent restaurants. One body of literature examined many facets of COVID-19, however it contained no research on restaurant sanitation during the COVID-19 outbreak. As a result, the researcher looked at restaurant cleanliness factors such personal hygiene of staff, hygiene of workplace, and hygiene of customer-use while also examining consumers' fear of COVID-19. The results showed that even after the Movement Control Order was relaxed, customers' fear of COVID-19 made them less likely to attend restaurants.

## REFERENCES

- Akter, M., Sadekin, M. N., & Patwary, A. K. (2020). An Empirical Study on Students' Satisfaction from Mawlana Bhashani Science & Technology University, Bangladesh. *Review of Economics and Development Studies*, 6(2), 363-379.
- Alom, S., Patwary, A. K., & Khan, M. M. H. (2019). Factors affecting the turnover intention of Bangladeshi migrants in the United Arab Emirates: An empirical study on the hotel industry. *International Journal of Innovation, Creativity and Change*, 8(3), 344-360.
- Boyras, G., Legros, D.N., Tigershtrom, A., 2020. COVID-19 and traumatic stress: the role of perceived vulnerability, COVID-19-related worries, and social isolation. *J. Anxiety Disord.* Retrieved from <https://www.sciencedirect.com/science/article/pii/S0887618520301213>
- Choi, H.C., MaClaurin, T., Cho, J.E., Hahm, S.P., 2010. Food hygiene standard satisfaction of singaporean diners. *J. Foodserv. Bus. Res.* 13, 156–177. <https://doi.org/10.1080/15378020.2010.500225>
- Delea, M.G., Snyder, J.S., Woreta, M., Zewudie, K., Solomon, A.W., Freeman, M.C., 2020. Development and reliability of a quantitative personal hygiene assessment tool. *Int. J. Hyg Environ. Health* 227, 113521. <https://doi.org/10.1016/j.ijheh.2020.113521>
- Fengmin, Z., Baijun, W., Jiangtao, B., Li, L., & Patwary, A. K. (2022). Investigating revisit intention of medical tourists in China through nutritional knowledge, perceived medical quality, and trust in the physiologist: A recommendation on health tourism policy measures. *Frontiers in Public Health*, 10, 893497.



- Hazbar, A. M. H., Alem Mohammed, A., & Karim, A. K. A. (2019). An Empirical Study of Factors Influencing hotel customers' online booking Intention. *مجلة العلوم التربوية و الدراسات الإنسانية*, (5), 1-17.
- Humanitarian Global (2021, November 18). Types of Hygiene. Retrieved from <https://humanitarianglobal.com/TYPES-OF-HYGIENE/>
- Hung, K.K.C., Mark, C.K.M., Yeung, M.P.S., Chan, E.Y.Y., Graham, C.A., 2018. The role of the hotel industry in the response to emerging epidemics: a case study of SARS in 2003 and H1N1 swine flu in 2009 in Hong Kong. *Glob. Health*. <https://doi.org/10.1186/s12992-018-0438-6>
- Jenkins P. (2022, July 4). How to Describe Fear in Writing. *Writing, Creativity, Filmmaking, Storytelling*. Retrieved from <https://brilliantio.com/how-to-describe-fear-in-writing/>
- Li, L., Ragavan, N. A., Patwary, A. K., & Baijun, W. (2022). Measuring patients' satisfaction toward health tourism in Malaysia through hospital environment, nutritional advice, and perceived value: A study on Chinese exchange students. *Frontiers in public health*, 10, 893439.
- Li, L., Wu, B., & Patwary, A. K. (2022). How marine tourism promote financial development in sustainable economy: new evidences from South Asia and implications to future tourism students. *Environmental Science and Pollution Research*, 29, 1155-1172.
- Li, L., Wu, B., & Patwary, A. K. (2022). The psychosocial factors affecting chinese Outbound Exchange and mobility students' academic performance during COVID-19. *Frontiers in psychology*, 13, 872516.
- Patwary, A. K., Roy, B., Hoque, R., & Khandakar, M. S. A. (2019). Process of developing a community based tourism and identifying its economic and social impacts: An Empirical study on Cox's Bazar, Bangladesh. *Pakistan Journal of Humanities and Social Sciences*, 7(1), 1-13.
- Schimmenti, A., Starcevic, V., Giardina, A., Khazaal, Y., Billieux, J. (2020b). Multidimensional Assessment of COVID-19-Related Fears (MAC-RF): A theory-based instrument for the assessment of clinically relevant fears during pandemics. *Frontiers in Psychiatry*, 11, 748. <https://doi:10.3389/fpsy.2020.00748>
- Sharma A., Noone B., Lee S., Yu C., Lin M., Jung I. H., Quadri-Felliti D., (2020). Restaurants and foodservice businesses during COVID, Restaurants and foodservice businesses during COVID-19. Available at: <https://covid19.ssri.psu.edu/articles/restaurants-and-foodservice-businesses-during-covid-19#:~:text=Restaurants%20need%20not%20only%20to%20improve%20their%20safety,will%20build%20on%20the%20elaboration%20likelihood%20model%20%28ELM%29>
- Shereen M. A., Khan S., Kazmi A., Bashir N., Siddique R. (2020). COVID-19 infection: Emergence, transmission, and characteristics of human coronaviruses. *Journal of Advanced Research*. Volume 24, July 2020, Pages 91-98. doi: <https://doi.org/10.1016/j.jare.2020.03.005>

- Sumethokula, P., Patwary, A. K., Srinuanpanc, B., Srinuanpand, C., Suwandee, P., Thammathikulf, A., & Phanong, W. (2020). The potential of new tour repackaging for creative tourism among entrepreneurs in Nakhon Si Thammarat. *International Journal of Innovation, Creativity and Change*, 13(10), 1752-1771.
- Wang H-Y, Li X-L, Yan Z-R, Sun X-P, Han J, Zhang B-W. Potential neurological symptoms of COVID-19. *Therapeutic Advances in Neurological Disorders*. 2020;13. <https://doi:10.1177/1756286420917830>
- WHO, 2020a. WHO Director-General's opening remarks at the media briefing on COVID-19 - (2020, 11 March) [WWW Document]. World Heal. Organ. URL <https://www.who.int/director-general/speeches/detail/who-director-general-s-opening-remarks-at-the-media-briefing-on-covid-19---11-march-2020> (2020)
- Wu, B., Liu, S., Wang, J., Tahir, S., & Patwary, A. K. (2021). Assessing the mechanism of energy efficiency and energy poverty alleviation based on environmental regulation policy measures. *Environmental Science and Pollution Research*, 28, 40858-40870.
- Wu, B., Zhai, B., Mu, H., Peng, X., Wang, C., & Patwary, A. K. (2021). Evaluating an economic application of renewable generated hydrogen: A way forward for green economic performance and policy measures. *Environmental Science and Pollution Research*, 1-15.
- Yu, J., Seo, J., Hyun, S.S., 2021b. Perceived hygiene attributes in the hotel industry: customer retention amid the COVID-19 crisis. Retrieved from <https://www.sciencedirect.com/science/article/abs/pii/S0278431920303200>
- Zhang, S., Diao, M.Y., Yu, W., Pei, L., Lin, Z., Chen, D., 2020. Estimation of the reproductive number of novel coronavirus (COVID-19) and the probable outbreak size on the Diamond Princess cruise ship: a data-driven analysis. *Int. J. Infect. Dis.* 93, 201–204. <https://doi.org/10.1016/j.ijid.2020.02.033>

# The Antecedent of Brand Love Toward Starbuck in Kuala Lumpur.

Nur Aisahtul Batrisyia Binti Mohd Kasuhairi, Nur Al Aiman Bin Firidaus, Nur Alya Hidayah Binti Abdullah, Nur Alya Syahirah Binti Shazli & Nurashikin Binti A Ridzuan\*

*Faculty Hospitality, Tourism and Wellness of Universiti Malaysia Kelantan*

[h20a1447@siswa.umk.edu.my](mailto:h20a1447@siswa.umk.edu.my), [h20a1452@siswa.umk.edu.my](mailto:h20a1452@siswa.umk.edu.my),  
[h20a1456@siswa.umk.edu.my](mailto:h20a1456@siswa.umk.edu.my), [h20a1457@siswa.umk.edu.my](mailto:h20a1457@siswa.umk.edu.my) &  
[nurashikin.ar@umk.edu.my](mailto:nurashikin.ar@umk.edu.my)\*

## ABSTRACT

---

*This study uses Starbucks as a case study to look at how consumer preference and brand loyalty are impacted by coffee quality. Research is also done into the elements that influence how healthful coffee is. Convenience, price equity, flavour, and customizability are all indicators of food quality. Hygiene and nutrition disclosure were the determining aspects of food healthiness. The most prominent food quality traits were brand admiration and brand loyalty. The results demonstrated a positive correlation between wellbeing and cleanliness and nutritional openness. Brand loyalty is significantly influenced by factors including flavour, customization, fairness of price, and healthfulness. Furthermore, it was discovered that fairness in terms of taste and cost were crucial elements in determining Starbucks brand loyalty. This investigation on food quality in the context of the coffee market offered useful business-related information. The study's findings highlighted the qualities of high-quality coffee and the factors that influence them, as well as the close relationship between brand love and loyalty, brand quality, and coffee food quality.*

### **Keywords:**

*Healthiness, price fairness, nutrition disclosure, brand love*

---

## 1. INTRODUCTION

Coffee has long been a significant global commodity crop and a substantial export for a number of nations. Coffee culture has evolved into a trend and way of life in today's societies, regardless of age (Nurhasanah & Dewi, 2020). This is so that young people can interact with one another through such culture. Seattle's Pike Place Market served as the site of the first Starbucks opening in 1971. It began modestly by offering some of the greatest coffee beans in the world for sale. Starbucks Coffee Company and Berjaya Group Berhad have partnered to

manage Starbucks in Malaysia through Berjaya Starbucks Coffee Company Sdn Bhd. It was founded on December 17th, 1998 in Kuala Lumpur and has since started to spread to Sabah and Sarawak.

Espresso, latte, and cappuccino are just a few of the coffee-containing beverages that Starbucks is renowned for offering. Customers are able to select their own drink based on preferences thanks to this. Because Starbucks gives customers a lot of options, this circumstance will boost customer happiness. Because the brand evokes for consumers symbolic attributes including social feelings, beauty, and status, consumers will grow acclimated to it (Gajic et al., 2022). But excessive coffee consumption increases the chance of developing chronic illnesses like diabetes, obesity, heart disease, and other conditions. This is due to the high sugar content of the beverages sold at Starbucks and the detrimental effects of excessive caffeine use on health (Lacap & Sicat, 2022). Because the cost of each menu item or dish at the Starbucks café is incredibly high and unattainable, the price justice of this study is another important consideration. When compared to other coffee shops or cafés, the price of each menu item or dish at Starbucks is prohibitively expensive. The purpose of this study was to look into the nutritional transparency, pricing justice, and healthiness of Kuala Lumpur consumers' brand loyalty to Starbucks.

### **Significance of The Study**

The researcher has examined the reaction on the dependent variable, which is brand love, by changes on the independent variables, which are the determinants consisting of the healthiness, price fairness, and nutrition disclosure of Starbucks in Kuala Lumpur, in accordance with the study's title, which examines the antecedents of brand love towards Starbucks in Kuala Lumpur. The researcher, the food and beverage industry, and potential customers now have a clear image of brand loyalty to Starbucks in Kuala Lumpur thanks to the research's findings.

## **2. LITERATURE REVIEW**

### **2.1 The Antecedents of Brand Love Toward Starbucks in Kuala Lumpur.**

The word "healthiness" is more frequently used as a synonym for health or wellness. From a range of scientific perspectives, including medical, nutritional, social, and psychological ones, health may be explored. Dietary factors and issues with food safety can be seen as the two main components of health. (Petrescu, Vermeir, & Petrescu-Mag, 2019).

Food health is also recognized as a crucial element in evaluating the calibre of food (Yoo, Lee, & Jeon, 2020). A healthy diet should be consumed by everyone. This is as a result of its ability to maintain a healthy heart. Heart disease is one of the leading causes of mortality for individuals in the US. A balanced diet can reduce your risk of getting heart disease, according to multiple studies. Oats and fruits are two examples of meals that are high in fibre and good for the heart. Studies claim that Starbucks coffee is nutritious and that they provide an environmentally friendly product. (Azriuddin, et al., 2020). In contrast, earlier research revealed that Starbucks-brand coffee had a low pH level, which suggests that it is acidic. The acidity in caffeine will cause tooth sensitivity (McDonagh, 2021). Healthy living has nothing to do with brand loyalty.

### **2.2 The Relationship Between Price Fairness and Brand Love of Starbucks in Kuala Lumpur.**

There are several studies that look at how people perceive prices in social science disciplines like marketing and economics. The meaning of price fairness is the user's assessment and feelings regarding whether the disparity between the seller's pricing and the comparable price of other parties is reasonable or acceptable (Xia, Monroe, & Cox, 2004). Depending on how the customer feels about the price, client satisfaction may go up or down. customers recognize price unfairness when they pay prices that are higher than rivals (Ting, 2013). Price fairness promotes increased sales because a fair price is very important to convince customers. According to studies, providing more satisfaction to customers will lead to higher customer loyalty (Kaura, Prasad, & Sharma, 2015).

### **2.3 The Relationship Between Nutrition Disclosure and Brand Love of Starbucks in Kuala Lumpur.**

Studies on the perception of pricing have been conducted in a variety of social science disciplines, including marketing and economics. The meaning of price fairness is the user's assessment and feelings regarding whether the disparity between the seller's pricing and the comparable price of other parties is reasonable or acceptable (Xia, Monroe, & Cox, 2004). Depending on how the customer feels about the price, client satisfaction may go up or down. customers recognize price unfairness when they pay prices that are higher than rivals (Ting, 2013). Fair pricing encourages improved sales since it's crucial to persuade buyers that a product is worth the price. According to studies, providing more satisfaction to customers will lead to higher customer loyalty (Kaura, Prasad, & Sharma, 2015). Everyone in the world is familiar with the Starbucks Coffee brand, including Malaysians. Although many individuals are willing to pay the high rates for the drinks, food, and merchandise offered at Starbucks, the demand for these items is always growing despite the perception that they are expensive. It is believed that fairness in terms of pricing is unimportant while making purchases of items.

However, given Starbucks brand loyalty in particular, this study and pricing fairness are closely related.

## 2.4 The Relationship Between Nutrition Disclosure and Brand Love of Starbucks in Kuala Lumpur.

The concept of "nutrition disclosure" describes the information provided or printed on each food and beverage package that details the numerous nutrients, calories, and food components that are present in the item. According to US Food and Drug Administration requirements, dietary information such as the amount of fat, calories, cholesterol, carbohydrates, sugar, protein, and vitamins present in each food package must be provided. It is also possible to think of nutrition disclosure as the labelling of inexpensive items that have the potential to encourage or support healthy eating habits. However, there are systematic variations that imply customers could not always use food labels while selecting foods. Given the poor dietary quality exhibited by many young adults, measuring the use of dietary facts among them is particularly important (Harris, Larsen, Chantala, & Udry, 2006). User traits, product type, and buying context are all related to how food labels are used. Users' capacity to interpret food labels may vary depending on where their nutritional education is at. Self-efficacy and trust are effective predictors of eating knowledge, attitudes towards food labels, and usage of food labels.

### Conceptual Framework

Figure 1 below has demonstrated how this study's conceptual framework worked. The dependent variable in this study was the factors influencing brand loyalty to Starbucks in Kuala Lumpur, while the independent variables were healthfulness, pricing fairness, and nutrition transparency. The relationship between the independent variables and the dependent variable was depicted in the image below.

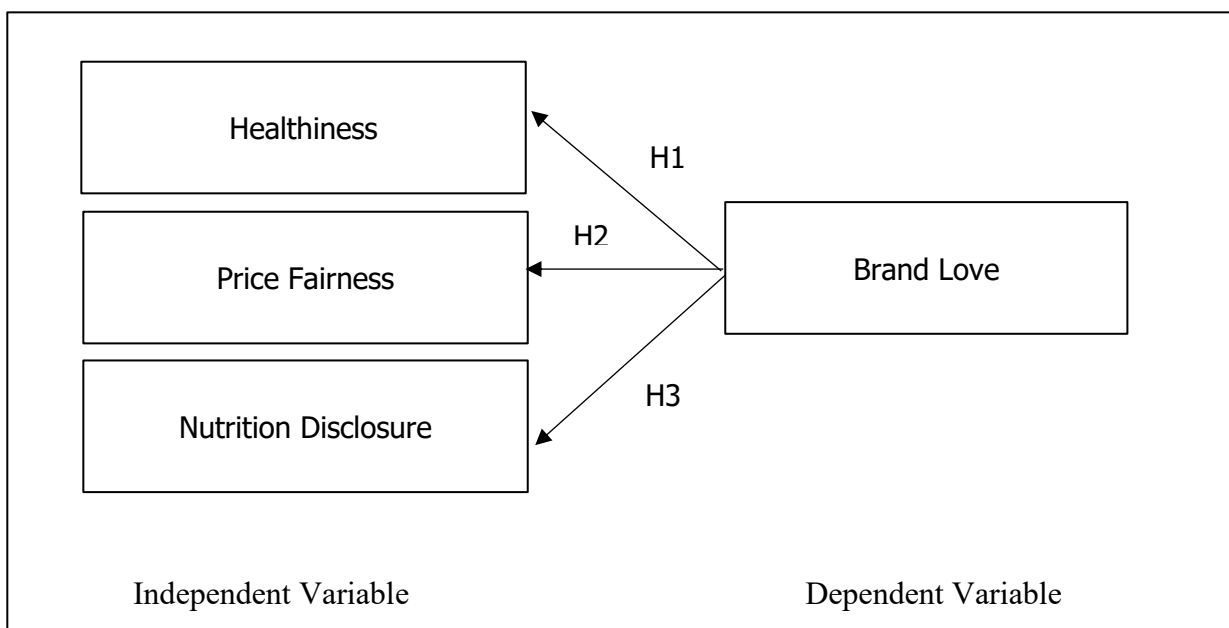

Figure 2.1: Conceptual Framework

Sources: Lee, Jung and Moon (2021)

### 3 METHODOLOGY

#### Research Design

The overall framework and methods the researcher selects for doing market research make up the research design. The chosen layout will allow the researcher to use the most appropriate research methods. This study used quantitative research as its primary research strategy. Data will be gathered from a representative sample of Starbucks patrons in Kuala Lumpur. In order to investigate and quantify the link between the independent and dependent variables, a descriptive methodology was adopted in this study. The researcher uses questionnaires that were obtained from respondents to explain the data.

#### Population

<b>Ethnic</b>	<b>Year 2020 ('000)</b>
Bumiputera	47.7%
Chinese	41.6%
Indians	10%
Others	0.7%

Table 3.1 Population by Ethnic Group in Malaysia

#### Sampling Size and Sampling Technique

The Department of Statistics Malaysia (2020) estimates that the sample size for the Malaysian population will be 33 million based on the table above. However, 384 respondents in total were chosen for this study's respondents based on the hypothesis from Krejcie and Morgan (1970).

For this investigation, the researcher's choice of sampling strategy was the convenience sampling approach. Non-probability sampling technique called convenience sampling includes taking samples from a particular group.

#### Instrument Development

##### Instrumentation

The questionnaire is divided into three parts, which are part A, B and C. Part A includes questions related to demographics. In part B, the researcher asked questions related to the chosen topic. It is closely related to the relationship between Starbucks and the factors of healthiness, price fairness and nutrition disclosure. The questions in part C discuss how often customers visit Starbucks.

<b>Sections</b>	<b>Variables</b>	<b>Items</b>	<b>Authors</b>
A	Demographic profile	5	Omar, Jamal & Nami (2017)
B	Healthiness	5	Lee, Jung & Moon (2021)
	Price Fairness	5	Lee, Jung & Moon (2021)
	Nutrition Disclosure	5	Lee, Jung & Moon (2021)
C	Frequency to Starbucks	5	Othman, Anuar, Izat & Fahmi (2019)

Table 3.2 : Overview of Research Instrument

The questionnaire's structure for both the independent variable and the dependent variable was a 6-point Likert scale for the sake of simplicity. From "Disagree very strongly" to "Agree very strongly," the 6-point Likert scale will range.

### **Data Collection and Data Analysis**

For this study, the researcher collected data using surveys and secondary sources. Malay and English-language questionnaires were distributed to respondents. The Statistics Package for Social Science (SPSS) will be used to analyse all of the data once data collecting is finished. The research's analytical process is broken down into two steps: preliminary data analysis and Pearson Correlation.



#### 4 RESULT

Table 1

##### Demographic Analysis

<b>Item</b>	<b>Frequency (n)</b>	<b>Percentage (%)</b>
<b>Gender</b>		
<i>Male</i>	177	46.1
<i>Female</i>	207	53.9
<b>Age Group</b>		
<i>Below than 20years old</i>	13	3.4
<i>20-29 years old</i>	319	83.1
<i>30-39 years old</i>	46	12.0
<i>40-49 years old</i>	3	0.8
<i>50 years old and above</i>	3	0.8
<b>Race</b>		
<i>Malay</i>	259	67.4
<i>Chinese</i>	63	16.4
<i>Indian</i>	37	9.6
<i>Other</i>	25	6.5
<b>Marital Status</b>		
<i>Single</i>	298	77.6
<i>Married</i>	46	12.0
<i>Divorced</i>	19	4.9
<i>Prefer not to tell</i>	21	5.5
<b>Monthly Income</b>		
<i>Below RM 1,000</i>	250	65.1
<i>RM 1,001 - RM 2,999</i>	87	22.7

<i>RM 3,000 - RM 3,999</i>	32	8.3
<i>RM 4,000 - RM 4,999</i>	9	2.3
<i>RM 5,000 - RM 5,999</i>	3	0.8
<i>RM 6,000 and above</i>	3	0.8
<b>Times visiting Starbucks in a month</b>		
<i>Once a month</i>	178	46.4
<i>2-3</i>	173	45.1
<i>4-5</i>	32	8.3
<i>6 times and above</i>	1	0.3
<b>Total</b>	<b>384</b>	<b>100</b>

Table 2

Descriptive Analysis

Table 4.6 : Mean Score for Each Variables

Section	Dimension	n	Mean	SD
<b>B</b>	<b>Healthiness</b>	384	4.0444	0.910
	<b>Price Fairness</b>	384	4.2052	0.846
	<b>Nutrition Disclosure</b>	384	4.1238	0.789
<b>C</b>	<b>Brand Love toward Starbucks</b>	384	4.2225	0.861

Table 3

Reliability Analysis

Variables	Cronbach's Alpha	N of Items
<b>Healthiness</b>	<b>0.928</b>	<b>5</b>
<b>Price Fairness</b>	<b>0.929</b>	<b>5</b>
<b>Nutrition Disclosure</b>	<b>0.922</b>	<b>5</b>
<b>Brand Love</b>	<b>0.932</b>	<b>5</b>

Table 4

## Pearson Correlation Coefficient

		BRAND LOVE
Healthiness (IV1)	Pearson Correlation	.819**
	Sig. (2-tailed)	.000
	N	384
Price Fairness (IV2)	Pearson Correlation	.893**
	Sig. (2-tailed)	.000
	N	384
Nutrition Disclosure (IV3)	Pearson Correlation	.830**
	Sig. (2-tailed)	.000
	N	384
Brand Love (DV)	Pearson Correlation	.830**
	Sig. (2-tailed)	.000
	N	384

\*\* . Correlation is significant at the 0.01 level (2-tailed).

## 5 DISCUSSION & RECOMMENDATIONS

This study looked into whether factors like price equity and nutrition information had an impact on how healthy a food was. According to this survey, food quality, flavour, and price equity were crucial components for consumers to enjoy the Starbucks brand. Customers may prefer a brand because it offers wholesome, delectable food and has prices that are reasonable for their means. This survey also showed that fair pricing and healthfulness were important motivators for Starbucks patronage. Customers at Starbucks were less likely to be loyal to the brand. In terms of fostering brand love and loyalty, competition and convenience are no longer relevant. Additionally, convenience might have less of an impact on market evaluation than other suggested criteria. Additionally, the findings indicated that healthiness was not essential for brand love, which may have been caused by the healthiness of Starbucks' products. Even though Starbucks goods listed their nutritional information and that they were made in a clean environment, they still contained dangerous substances like sugar and caffeine. Starbucks products were prepared in sanitary conditions and included nutrition information, but they still contained unhealthy ingredients like sugar and caffeine. Through the analysis of descriptive data for wellness, this can be concluded. The results supported previous finding that contentment had a positive effect on brand love. (Sallam's, 2015)

### Implication of The Study

First of all, this research study gave any new researcher or entrepreneur interested in this topic all the pertinent information, particularly regarding how healthiness, pricing fairness, and nutrition disclosure influence brand love of Starbucks in Kuala Lumpur. The researcher will be able to better investigate the causes of brand loyalty to Starbucks in Kuala Lumpur with the aid of this information. In addition, this study enabled the new researcher to identify crucial, understudied factors that may contribute to Kuala Lumpur consumers' love of Starbucks. From

here, this study may help upcoming researchers locate research findings with a higher likelihood of being effective in this research area. Additionally, by consulting this research article, a future researcher may develop the instinct necessary to carry out the research. In the meanwhile, our study can serve as a template for future literature reviews. Our study can now be used as a model for further literature reviews.

Second, this study is advantageous to the food and beverage sector since it sheds light on the causes of brand loyalty for Starbucks in Kuala Lumpur. The food and beverage sector can pinpoint consumer drivers of brand loyalty expectations on health, price equity, and nutrient disclosure. In order to fully satisfy customer purpose, the food and beverage business must do in-depth research into the causes of brand love for Starbucks in Kuala Lumpur. As a result, the food and beverage business can profit by making better decisions and gaining competitive advantages.

Third, this study will be useful to customers who want to go to the Kuala Lumpur Starbucks. Customers will be made aware of the availability of diet-friendly and nutritional food options. Before purchasing food and beverages at Starbucks Kuala Lumpur, customers can prepare their menu in advance. They are also aware that Starbucks charges a price commensurate with the quality of service it offers its consumers. Premium ingredients are used to prepare the meals and beverages at Starbucks. Customers will also be more aware of their right to know the nutritional information for every product they purchase. Customers can choose to love the Starbucks brand in this way. The customer will become a wise consumer of goods and services as a result of this study.

### **Recommendation of The Study**

There are numerous suggestions for more consumer revisit intention research. Therefore, questions in future study should be intriguing and acceptable to everyone so that respondents will consent during the questionnaire. As a result, the researcher can give respondents to future studies questionnaires that are easier to understand and more engaging.

For every purpose, not every research methodology is adequate. For instance, it is important to carefully examine the type and length of interviews while conducting research with unique populations. The intended user group should be taken into consideration while creating the test tasks for a usability test. You must look at the group you are looking at, the objective of the research, and the likely result you want from it.

The researchers only looked at three criteria that could impact customers in this study. However, the researchers may have overlooked some crucial characteristics that play a vital role in defining the antecedents of brand love for Starbucks in Kuala Lumpur. As a result, future research is advised to undertake further research into other characteristics such as location, pricing, and amenities in order to improve the study's results.

## 6 CONCLUSION

In conclusion, there are still has some few steps to investigate the antecedents of brand love toward Starbucks in Kuala Lumpur. The selected independent variables are well suited to be combined with the dependant variable.

The study has effectively shown that the majority of respondents cited brand loyalty as the main reason they kept coming back to Starbucks. Since every Starbucks offers virtually the same food and service, business owners must concentrate on providing food that meets consumer demands and create remarketing plans to bring in new clients. Profits may also rise as a result of this.

People frequently go to cafes before work or to hang out with their closest friends. Starbucks coffee is always in demand. Starbucks should maintain growing their product line and keep a close eye on emerging technological developments because their target customer expects this. Starbucks must maintain the distinctive customer approach that makes their brand so recognised and encourages repeat business despite an expanding client base.

## References

- Akter, M., Sadekin, M. N., & Patwary, A. K. (2020). An Empirical Study on Students' Satisfaction from Mawlana Bhashani Science & Technology University, Bangladesh. *Review of Economics and Development Studies*, 6(2), 363-379.
- Alom, S., Patwary, A. K., & Khan, M. M. H. (2019). Factors affecting the turnover intention of Bangladeshi migrants in the United Arab Emirates: An empirical study on the hotel industry. *International Journal of Innovation, Creativity and Change*, 8(3), 344-360.
- Dudovskiy, J. (2019). Suggestions for Future Research - Research-Methodology. Retrieved from Research-Methodology website: <https://research-methodology.net/research-methodology/suggestions-future-research/>
- Fengmin, Z., Baijun, W., Jiangtao, B., Li, L., & Patwary, A. K. (2022). Investigating revisit intention of medical tourists in China through nutritional knowledge, perceived medical quality, and trust in the physiologist: A recommendation on health tourism policy measures. *Frontiers in Public Health*, 10, 893497.
- Gajić, T., Raljić, J. P., Blešić, I., Aleksić, M. M., Petrovic, M., Radovanović, M., Vuković, D., Sikimić, V., Pivac, T., Kostic, M., Sekulic, D., Vukolić, D., Penić, M., & Ivanović, O. M. (2022). Factors That Influence Sustainable Selection and Reselection Intentions Regarding Soluble/Instant Coffee—The Case of Serbian Consumers. *Sustainability*, Retrieved from 14(17), 10701. <https://doi.org/10.3390/su141710701>
- Hazbar, A. M. H., Alem Mohammed, A., & Karim, A. K. A. (2019). An Empirical Study of Factors Influencing hotel customers' online booking Intention. *مجلة العلوم التربوية و الدراسات الإنسانية*, (5), 1-17.
- Lacap, J. P., & Sicat, A. T. (2022). Effect of Experiential Quality on Experiential Loyalty: Evidence from Starbucks Coffee Chains in Pampanga, Philippines. *Asia-Pacific Social Science Review*.

- Li, L., Ragavan, N. A., Patwary, A. K., & Baijun, W. (2022). Measuring patients' satisfaction toward health tourism in Malaysia through hospital environment, nutritional advice, and perceived value: A study on Chinese exchange students. *Frontiers in public health*, 10, 893439.
- Li, L., Wu, B., & Patwary, A. K. (2022). How marine tourism promote financial development in sustainable economy: new evidences from South Asia and implications to future tourism students. *Environmental Science and Pollution Research*, 29, 1155-1172.
- Li, L., Wu, B., & Patwary, A. K. (2022). The psychosocial factors affecting chinese Outbound Exchange and mobility students' academic performance during COVID-19. *Frontiers in psychology*, 13, 872516.
- Michelli, J. A. (2009). The Starbucks Experience - by Joseph a Michelli. *NHRD Network Journal*, 2(7), 100–101. <https://doi.org/10.1177/0974173920090718>
- Nurhasanah, S., & Dewi, C. M. (2020). THE EMERGENCE OF LOCAL COFFEE SHOPS IN INDONESIA AS A COUNTER TO AMERICAN CULTURE HEGEMONY. *Rubikon*. Retrieved from <https://doi.org/10.22146/rubikon.v6i1.61485>
- Patwary, A. K., Roy, B., Hoque, R., & Khandakar, M. S. A. (2019). Process of developing a community based tourism and identifying its economic and social impacts: An Empirical study on Cox's Bazar, Bangladesh. *Pakistan Journal of Humanities and Social Sciences*, 7(1), 1-13.
- Song, H., Wang, J., & Han, H. (2019). Effect of image, satisfaction, trust, love, and respect on loyalty formation for name-brand coffee shops. *International Journal of Hospitality Management*, 79, 50–59. <https://doi.org/10.1016/j.ijhm.2018.12.011>
- Sumethokula, P., Patwary, A. K., Srinuanpanc, B., Srinuanpand, C., Suwandee, P., Thammathikul, A., & Phanong, W. (2020). The potential of new tour repackaging for creative tourism among entrepreneurs in Nakhon Si Thammarat. *International Journal of Innovation, Creativity and Change*, 13(10), 1752-1771.
- Wu, B., Liu, S., Wang, J., Tahir, S., & Patwary, A. K. (2021). Assessing the mechanism of energy efficiency and energy poverty alleviation based on environmental regulation policy measures. *Environmental Science and Pollution Research*, 28, 40858-40870.
- Wu, B., Zhai, B., Mu, H., Peng, X., Wang, C., & Patwary, A. K. (2021). Evaluating an economic application of renewable generated hydrogen: A way forward for green economic performance and policy measures. *Environmental Science and Pollution Research*, 1-15.

## Factors That Influence Customers Satisfaction Toward Fast Food Restaurant in Kota Bharu.

**Nur Anis binti Zainuddin, Nur Aqilah binti Norzli, Nur Asfa Izzati binti Abdullah, Nur Asmaawanie binti Ayub & Harnidah Binti Samengon**

*Faculty of Hospitality, Tourism and Wellness, University Malaysia Kelantan*

Corresponding email: h20a1469@umk.edu.my

### **Abstract**

This study aims to evaluate the physical, operational environment, food and service quality, and customer satisfaction in Kota Bharu, Kelantan. For this study, any kind of fast-food establishment was considered to be quick. In order to better understand the relationship between factors and customer re-intention, the survey uses a quantitative technique to collect relevant data in the form of a questionnaire. Data came from patrons who frequented randomly chosen fast food outlets in Kota Bharu. To analyse the collected data, descriptive statistics and Pearson correlation analysis were employed. Respondents received a total of 384 questionnaires. Customer retention is strongly correlated with the three factors of food quality, service quality, and physical and operational environment. However, according to the study's findings, food quality has a moderate relationship. These results demonstrate that the environment affects customer intentions, consistent with earlier research. This study has given the industry knowledge on the re-intention of customers to fast food restaurants in Kota Bharu. This knowledge will help the industry adapt to the re-intention of customers and gain a competitive advantage. Finally, it is suggested that additional factors be considered in future studies to investigate and uncover other causes.

**Keywords:** *food quality, service quality, physical environment, customer re-intention, questionnaire*

### **INTRODUCTION**

The worldwide fast-food market has been expanding consistently at a rate of 4.2% since 2017 (Becker, Lee & Nobre, 2018; Cho, 2021), and the industry's net worth was predicted to be far above US\$690 billion in 2022 (Zion Market Research, 2019). Urbanization and the development of busy lifestyles and technology have drastically changed how many people live, including those in developing countries. Eating habits have also shifted simultaneously with this rapidly developing technology. People rely more on ready-to-eat foods to sustain their livelihoods supported by businesses (Mehdi, Raza & Riza, 2022). Iqbal (2020) asserts that although the globalisation of food and cuisine is primarily a twentieth-century event, there have been clear trends towards proto-globalization in the production, distribution, and consumption of food across earlier historical eras.

Fast food is defined by Shaban and Alkazemi (2019) as food that is consumed quickly and comes from global fast-food chains. Kee et al. (2012), on the other hand, define fast-food

establishments as those that provide speedy service of meals. Malaysia's fast-food restaurant market is growing and being adapted to suit regional dietary requirements. Fast-food restaurants set themselves apart from other kinds of eateries because to their unique characteristics, which include quick service, minimal customer interaction, and affordable costs. (Chian, 2020).

In Malaysia, fast food chains, including Marry Brown, McDonald's, Pizza Hut, and Subway, are highly known. Each year, the overall number of fast-food outlets has dramatically expanded. The first fast-food restaurants in Malaysia opened in the 1970s and early 1980s. With a capital of RM 24,300.00, A&W was the first fast-food chain to be introduced in Malaysia in 1963. KFC began operations in Kuala Lumpur in 1972 with a capital investment of RM 60,000.00 and quickly expanded, eventually having 11 locations as opposed to A&W's six at the time (Kee et al., 2021). The largest restaurant chain in Malaysia is run by QSR brands, the master franchise of KFC and Pizza Hut, based on market share and the number of locations (The Malaysia Reserve, 2018). According to market share, KFC (45%) and Pizza Hut (23%) lead Malaysia's fast-food retailing and quick-service segments (QSR Brands, 2018).

The hospitality sector is now regarded as successful, especially as more and more customers value quality over quantity. In a customer-focused industry like the hospitality sector, service is essential. It was asserted that the hospitality industry's service quality was fiercely competitive in achieving client happiness. Customer pleasure has been linked to success and superior service. A corporation's two most crucial components are service quality and client pleasure. Thanks to its way of joy, the business may precisely and successfully boost its reputation (Yee, 2021). Zhong and Moon (2020) contend that in order to compete with local eateries and increase profits, Western fast-food companies must focus more on price, service quality, food quality, and physical environment. Customer satisfaction is significantly impacted by a restaurant's level of service, food, and ambiance. It's important to keep customers happy because doing so can lead to repeat business and bigger sales.

This study intends to bridge the gap by examining the impacts of the three components of restaurant service quality (food quality, service quality, and physical environment quality) on patron satisfaction in fast-food outlets (Simpong et al., 2022).

## **LITERATURE REVIEW**

### ***1.1 Factors That Influence Customers Satisfaction***

#### ***1.1.1 The Relationship between Food Quality and Customers Satisfaction***

The definition of fast food differs from person to person, but most agree that the foods are mass-produced and made available in a short window, cutting the time lost from cooking meals at home. This makes fast food popular among youngsters, but families may also find themselves buying the products occasionally. However, fast foods usually have high fat and may cause dietary illnesses. Cheong Siew Man and Lim Kuang Hock (2021) said that sociodemographics is important to see which generation consumes fast food the most to prevent dietary illnesses.

For food quality, Liu and Jang (2009) argued that food quality must include food safety, which is the practice of handling raw food and ingredients, food preparation, food freshness and food tastiness. This was backed up by Violetta Njunina (2021), who asserted that harnessing the



five senses of the human body to prepare meals and attract clients is crucial. According to Abd Ghoni et al. (2021), there is a proven link between the calibre of the cuisine and patron pleasure at fast food establishments.

### ***1.1.2 The Relationship between Service Quality and Customers Satisfaction***

Zeithaml et al. (1988) stated that service quality is a form of review by customers while being in or served at a restaurant, saying that there are five major aspects to be evaluated; those are reliability, tangibility, responsiveness, assurance and empathy which lead to a procedure scale named SERVQUAL. Although SERVQUAL was no longer used in the current era, its influence on measuring customer satisfaction remains important.

Nikolich (1995) further explained that the interaction between service providers of a restaurant and customers would result in service quality evaluation, to which Brady and Robertson (2001) agreed. This is demonstrated by the fact that patrons who are pleased with the restaurant's service will frequently return to make more purchases. The argument was further reinforced by Abd Ghoni et al. (2021), who claimed that there is a strong link between customer satisfaction and service quality.

### ***1.1.3 The Relationship Between Physical Environment Quality and Customer Satisfaction***

According to Othman et al. in 2009, the physical condition of a restaurant's working environment is crucial for achieving customer satisfaction. They claimed that although the building appearance and colors were not as important, customers became conscious of food-borne illnesses, became more cautious in buying fast food, and thought that fast food restaurants should be more than a place for a quick dine-in.

Customers will be glad to be greeted by great qualities including a broad area, eye-catching designs, and cleanliness of the premises, according to Abdul Rahman et al. (2019). After that, Nawi et al. (2022) concurred that there is a connection between fast-food businesses' physical operational environments and patron pleasure.

## ***Conceptual Framework***

The conceptual structure of this study is displayed in Figure 1 below. The dependent variable in this study was consumer satisfaction with Kota Bharu fast food establishments. The meal quality, service quality, and physical environment quality, in contrast, were the study's independent factors. The relationship between the independent variables and the dependent variable is depicted in the image below.

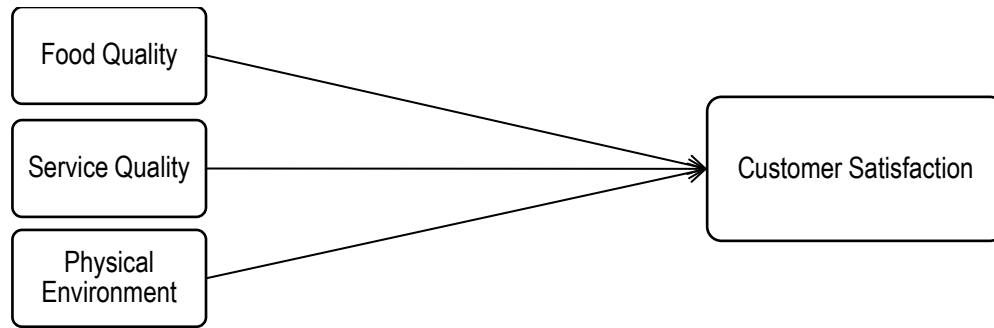

Independent Variables

Dependent Variable

Figure 1.1: Relationship between the Independent Variables and Dependent Variable

Sources: Framework adopted from Zhong & Moon (2020)

## METHODOLOGY

### *Research Design*

The quantitative analysis used in this study is the most effective method for achieving the research objective. In this study, quantitative research uses questionnaire surveys to gather data.

### *Population*

Table 3.1: Population by Gender Group in Kota Bharu

	Year
	2023
<b>Total</b>	<b>1741597</b>
Men	893847
Women	847749

Source: Department of Statistics Malaysia (2023)

### *Sampling Size and Sampling Technique*

From the table above, the sample sizes for all customers who are satisfied with fast food restaurants in Kota Bharu have been selected, with a total population of 1741597 respondents; 384 respondents were chosen as respondents in this study based on the theory from Krejcie and Morgan (1970).

Convenience sampling is being used by the researchers as their sample strategy for this investigation. Non-probability sampling, or convenience sampling, includes selecting a sample from a particular group. The respondents are easily accessible at the appropriate time and location, it just takes a short amount of time to collect the data, and it is reasonably expensive.

## **Instrumentation Development**

### ***Instrumentation***

There will be three sections to the questionnaire. The demographic information is in Section A, the factors are discussed in Section B, and the link between the factors and the dependent variable is examined in Section C. The nominal scale, which is used to name variables without any quantitative value, is the initial measurement that is applied. The second measurement that is being used is the ordinal scale. Rating scales are used to measure the statements in the questionnaire, such as Likert scale.

The framework of the questionnaire, which includes both independent and dependent variables, is a five-point Likert scale for simplicity's sake. A seven-point Likert scale with "Strongly Disagree" at one extreme, "Strongly Agree" at the other, and "Neutral" in the middle would be used.

### ***Data Collection and Data Analysis***

In order to gather quantitative data for this study on the patrons of fast-food restaurants in Kota Bharu regarding their satisfaction with elements like food quality, service quality, and physical environment quality that will impact their ability to fulfil demand, a questionnaire was used. Following data collection, the IBM Statistical Package for Social Science (SPSS) will be used to evaluate all of the collected data. The descriptive data analysis and Pearson Correlation techniques make up the research's analytical process.

## **CONCLUSION**

This chapter contains the results of the essential study on the variables affecting patron satisfaction with fast food establishments in Kota Bharu. The study's goals have been achieved, its questions have been answered, and its hypotheses have been accepted based on the examination of 384 valid questionnaires.

Overall, there is a modest association between customer satisfaction and service quality as well as a large positive relationship between food quality and customer contentment.

The meal quality correlation value, which influences consumers' intent to return, is the highest of the study's variables. The survey has effectively demonstrated that the majority of participants think that the quality of the food is the primary element deciding whether or not they will visit a fast-food restaurant again, with the environment having the least bearing on their choice. Since the majority of fast food establishments in Kota Bharu offer comparable goods and services, their owners ought to start putting more of an emphasis on serving meals in a welcoming and welcoming setting to draw repeat customers and boost revenues.

## REFERENCES

- Akter, M., Sadekin, M. N., & Patwary, A. K. (2020). An Empirical Study on Students' Satisfaction from Mawlana Bhashani Science & Technology University, Bangladesh. *Review of Economics and Development Studies*, 6(2), 363-379.
- Alom, S., Patwary, A. K., & Khan, M. M. H. (2019). Factors affecting the turnover intention of Bangladeshi migrants in the United Arab Emirates: An empirical study on the hotel industry. *International Journal of Innovation, Creativity and Change*, 8(3), 344-360.
- Becker, K., Lee, J. W., & Nobre, H. M. (2018). The concept of luxury brands and the relationship between consumer and luxury brands. *Kip Becker, Jung Wan Lee, Helena M. Nobre/Journal of Asian Finance, Economics and Business*, 5(3), 51-63.
- Brady, M. K., & Robertson, C. J. (2001). Searching for a consensus on the antecedent role of service quality and satisfaction: an exploratory cross-national study. *Journal of Business research*, 51(1), 53-60.
- Chian, S. L. (2020). Factors influencing customer satisfaction in Johor Bahru fast food industry. *Journal of Arts & Social Sciences*, 4(1), 59-71.
- Cho, M. R. (2021). Global Service Innovation: A Case Study of Ajisen Ramen. *The Journal of Asian Finance, Economics and Business*, 8(3), 967-976.
- Fengmin, Z., Baijun, W., Jiangtao, B., Li, L., & Patwary, A. K. (2022). Investigating revisit intention of medical tourists in China through nutritional knowledge, perceived medical quality, and trust in the physiologist: A recommendation on health tourism policy measures. *Frontiers in Public Health*, 10, 893497.
- Hazbar, A. M. H., Alem Mohammed, A., & Karim, A. K. A. (2019). An Empirical Study of Factors Influencing hotel customers' online booking Intention. *مجلة العلوم التربوية و الدراسات الإنسانية*, (5), 1-17.
- Li, L., Ragavan, N. A., Patwary, A. K., & Baijun, W. (2022). Measuring patients' satisfaction toward health tourism in Malaysia through hospital environment, nutritional advice, and perceived value: A study on Chinese exchange students. *Frontiers in public health*, 10, 893439.
- Li, L., Wu, B., & Patwary, A. K. (2022). How marine tourism promote financial development in sustainable economy: new evidences from South Asia and implications to future tourism students. *Environmental Science and Pollution Research*, 29, 1155-1172.
- Li, L., Wu, B., & Patwary, A. K. (2022). The psychosocial factors affecting chinese Outbound Exchange and mobility students' academic performance during COVID-19. *Frontiers in psychology*, 13, 872516.
- Lim, G., & Ng, K. K. (2022). Capital mobility and centre–state relations: unpacking the spatial configuration of real estate investment in Iskandar Malaysia. *Territory, Politics, Governance*, 1-17.
- Liu, Y., & Jang, S. S. (2009). The effects of dining atmospherics: An extended Mehrabian–Russell model. *International journal of hospitality management*, 28(4), 494-503.
- Majid, M. A. A., Rojiei, A. M., Shafii, N. A. M., Abd Ghoni, N. N., & Hassan, H. (2021). Factors influencing customer satisfaction at fast food restaurant in Klang Valley,

Malaysia. *International Journal of Advanced Research in Economics and Finance*, 3(3), 248-256.

- Man, C. S., Hock, L. K., Ying, C. Y., Cheong, K. C., Kuay, L. K., Huey, T. C., ... & Aziz, N. S. A. (2021). Is fast-food consumption a problem among adolescents in Malaysia? An analysis of the National School-Based Nutrition Survey, 2012. *Journal of Health, Population and Nutrition*, 40(1), 1-9.
- Market, A. R. T. K. (2019). Global industry perspective, comprehensive analysis and forecast, 2018–2025. *New York: Zion Market Research*, 110.
- Mat Nawi, N. M., Shahril, Z., Hamid, R., & Nik Hashim, N. A. A. (2022). A conceptual framework: examination the role of physical environment on Airbnb experiences. *Journal of Tourism, Hospitality and Culinary Arts*, 14(1), 380-392.
- Mohd Nazri, F. N., Simpong, D. B., & Mohd Radzi, N. A. (2022). The effect of restaurant service quality on customer satisfaction: a conceptual paper. *Journal of Tourism, Hospitality and Culinary Arts*, 14(1), 187-199.
- Nikolich, M. A., & Sparks, B. A. (1995). The hospitality service encounter: the role of communication. *Hospitality Research Journal*, 19(2), 43-56.
- Parasuraman, A., Zeithaml, V. A., & Berry, L. (1988). SERVQUAL: A multiple-item scale for measuring consumer perceptions of service quality. 1988, 64(1), 12-40.
- Patwary, A. K., Roy, B., Hoque, R., & Khandakar, M. S. A. (2019). Process of developing a community based tourism and identifying its economic and social impacts: An Empirical study on Cox's Bazar, Bangladesh. *Pakistan Journal of Humanities and Social Sciences*, 7(1), 1-13.
- Shaban, L., & Alkazemi, D. (2019). Trends in fast-food consumption among Kuwaiti youth. *International journal of preventive medicine*, 10.
- Sumethokula, P., Patwary, A. K., Srinuanpanc, B., Srinuanpand, C., Suwandee, P., Thammathikul, A., & Phanong, W. (2020). The potential of new tour repackaging for creative tourism among entrepreneurs in Nakhon Si Thammarat. *International Journal of Innovation, Creativity and Change*, 13(10), 1752-1771.
- Susilowati, E., & Sari, A. N. (2020). The influence of brand awareness, brand association, and perceived quality toward consumers' purchase intention: a case of cheese factory, Jakarta. *Independent Journal of Management & Production*, 11(1), 039-053.
- Malaysian Communications and Multimedia Commission. (2017). *Internet Users Survey*. Malaysia: Malaysian Communications and Multimedia Commission,.
- Wu, B., Liu, S., Wang, J., Tahir, S., & Patwary, A. K. (2021). Assessing the mechanism of energy efficiency and energy poverty alleviation based on environmental regulation policy measures. *Environmental Science and Pollution Research*, 28, 40858-40870.
- Wu, B., Zhai, B., Mu, H., Peng, X., Wang, C., & Patwary, A. K. (2021). Evaluating an economic application of renewable generated hydrogen: A way forward for green economic performance and policy measures. *Environmental Science and Pollution Research*, 1-15.
- Zhong, Y., & Moon, H. C. (2020). What drives customer satisfaction, loyalty, and happiness in fast-food restaurants in China? Perceived price, service quality, food quality, physical

environment quality, and the moderating role of gender. *Foods*, 9(4), 460.

# Intention To Eat Kelantan Traditional Food Among UMK Students At City Campus

Nur Athirah Binti Alias, Nur Atilla Alysha Binti Mohamad Ridzuan, Nur Auni Binti MatRazid, Nur Farah Izzati Binti Azman & Nur Dalila Binti Mat Yusoff

*Faculty of Hospitality, Tourism and Wellness, University Malaysia Kelantan*

*Corresponding email: nurdalila@umk.edu.my*

---

## ABSTRACT

Traditional food is food passed down from generation to generation. This traditional food symbolizes an ethnic group in Malaysia. This research focuses on the intention to eat Kelantan traditional food among UMK students, which is closely related to taste, family practice and convenience. In carrying out this research, quantitative methods were used as a tool to collect data from the respondents. To analyze and identify the data of this study, descriptive analysis, reliability test and Pearson Correlation were used. This study found that taste, family practice and convenience are closely related to the intention to eat Kelantan traditional food among UMK students. The researcher used primary data for data collection, including a simple sampling method to select 361 respondents from students at UMK City Campus. There are 361 respondents from students at UMK City Campus who have participated in this study.

**Keywords: Intention to eat, traditional food, taste, family practice and convenience**

---

## INTRODUCTION

Traditional food or local cuisine is something which past generations have consumed, and which has been around for a long time. There is no doubt that traditional cuisines and dishes have a rich history as national, regional, or local dishes. Traditional foods and beverages can be made at restaurants, small production facilities, big food processing plants, or even at home. Traditional foods are viewed as a focal point of one's cultural heritage, which may be recognized by the origin because they are important in bringing back memories, identities, and authenticity to every culture, race, religion, and country (Perry, 2017).

Based on the statistics released by the Department of Statistics Malaysia (DOCM) (2022) has shown that the Malays show the highest percentage of (69.6%), Chinese (22.8%), Indians (6.6%) and other races (0.7%). Malaysian cuisine and food are known for their rich and unique flavor. Malaysian traditional food is produced ingeniously using the finest and freshest local products, and the subsequent generation receives the recipes (Salleh, 2006). Malaysia, which has a cosmopolitan culture because it has inherited and maintained the identity of various types of traditional food, has developed its combination of mixes to give birth to traditional Malaysian cuisine that appeals to all groups of people. Every culture, ethnicity, religion, and nation need to evoke memories, identity, and validity.

There are three objectives of this research:

1. To identify the relationship between taste towards intention to eat Kelantan traditional Kelantan food among UMK students at City Campus.
2. To identify the relationship between family practice towards intention to eat Kelantan traditional food among UMK students at City Campus.
3. To identify the relationship between convenience towards intention to eat Kelantan traditional food among UMK students at City Campus.

## **SIGNIFICANCE OF THE STUDY**

The subsequent researcher's future efforts to learn more about traditional foods will benefit from this study's result as well. It also intends to teach the next generation about the necessity of preserving this old culinary history and learning about traditional dishes. According to study and information on this Malaysian Traditional Food, it can and will continue to help the expansion of our country's tourist business. The results of this research will also help the young generation of new eateries, street food vendors, and food trucks by educating them about heritage foods and enhancing their appreciation of the importance of proper food handling techniques. Additionally, it would allow the younger generation to improve the quality of traditional foods in a clean and uncontaminated state.

### **Traditional Food**

Traditional foods are those that have been consumed for generations and have been handed down. Malaysia is native to numerous ethnic groups, each with its own traditional cuisine. Malaysia, particularly in Kelantan has a distinct traditional cuisine from other nations because of interaction and integration between various ethnic groups because it has been a melting pot of numerous cultures for so long. However, the younger generation particularly those in the generation Z has gradually rarely eaten traditional food because of the influence of information technology.

### **Student**

The knowledge of young people, particularly students can be improved by this research, as students are increasingly engrossed in information technology (IT). So, this research will guide them to try traditional food, particularly Kelantan traditional food. This research will provide useful information about traditional foods allowing students to become more acquainted with the environment.

### **Intention**

Traditional foods are significant because they provide better immunity to illness, and nutrient-dense traditional foods may also contribute to weight control and wellness. For



instance, heart health, bone health, and mental heart health. So, eating with a purpose or goal is choosing a wise food choice to fuel whatever you want to achieve with your meal. As a result, your intentions provide you with the guidance you require to achieve your objectives. Setting intentions in the morning may assist you in achieving any objective, such as starting a life coaching company or finding a new relationship.

## **LITERATURE REVIEW**

### **Intention To Eat Kelantan Traditional Food**

Eating with intention entails making a strategy that goes beyond simply deciding what to cook and eat. It is also about achieving a goal and making decisions that will benefit your work-life balance and healthy nutrition. Intention also gave you the attention you required to advance toward your goals. Eating with intention also means eating in a way that helps your body, mind, and spirit stay clear, energized, and at their best. It is eating from a position of self-love and genuine nutrition. Intention theories aim to capture the unique features of intentions. Historically, the belief-desire hypothesis has been the prevailing method. The desire to execute a certain action and the conviction that one will perform that action are two simple definitions of having an intention. As several counter examples show, belief-desire theories are widely questioned since neither beliefs nor wants to require a real commitment to acting. The evaluation theory, which explains intents in terms of unconditional assessments, addresses this issue. In other words, unlike wants intentions show the desired path of action as being beneficial in all aspects.

## **TASTE**

Taste and food quality are influenced by a few factors, including food presentation, variety, healthy options, freshness, taste, temperature, and portion size. These factors can improve dining experiences and, as a result, influence customer behaviour, such as their intention to return. In terms of food taste, food quality, and food serving style, Kelantan's traditional local cuisine provides a genuinely satisfying dining experience (Nguyen et al., 2019). A few of the traditional foods from Kelantan are still popular with people today, including Nasi Kerabu, Laksam Kelantan, Ayam Percik, Kerabu Sare, Kuih Akok, Bahulu, and others. Due to the culture of Kelantan is known as a state that likes to eat sweet food, sweet cakes like Kuih Akok are famous in Kelantan and loved. The sweetness of Kuih Akok has attracted the interest of both locals and visitors from outside Kelantan to the point where they are willing to come to Kelantan just to get it. Food preferences and perceptions are influenced not only by the taste, aroma, or texture of foods but also by eating habits (Drewnowski, 1997). This demonstrates how unique the eating patterns of Kelantanese are, who love sweet foods like Kuih Akok. Furthermore, "natural taste" refers to a food taste that has not been altered by artificial aromas and flavour enhancers (Commission, 2007).

## **Family Practice**

A family is a group that contributes to an important social norm for the young generation. According to (Muhammad Shahrin Ab Karim,2015), when it comes to nutrition, the family is the most important group that significantly affects how adolescents behave. It was shown from several previous studies that the result will vary depending on the structure of the family itself. The parents are typically the main factors in determining how their children will eat and will shape and determine that behavior. There are two possible motivating factors for people to follow the eating norm (Higgs, 2015). Second, maintaining a healthy diet may be made easier by adhering to the rules. Malay traditional nutrition and practices for children begin at home since eating routines and practices learned as children must have the highest likelihood of remaining in place as adults (Bava et al., 2008; Kimura et al., 2010; Pedersen, Gronhoj, and Thogersen, 2015; Videon and Manning, 2003).

## **CONVENIENCE**

Daniels and Glorieux (2015) define convenience foods as any fully or partially prepared foods whose preparation time, knowledge, culinary expertise, or energy inputs have been transmitted from the home kitchen to the food processor or other food distributors. In other words, both the transmission of culinary skills and the saving of time and energy are directly related to convenience meals. In addition, it seeks to simplify meal selection and preparation for the public. According to Boer, McCarthy, Cowan, and Ryan (2004), convenience food is typically associated with minimizing the amount of effort required to acquire food, prepare, cook, or clear up after a meal. Contrary to prevalent belief, eating away from home is not equivalent to consuming fast food. Eating out can be viewed as a social occasion, whereas convenience foods are typically associated with meals and snacks consumed to provide individuals with time and opportunity to pursue other activities.

## **Relationship Between Taste, Family Practise And Convenience Toward Intention To Eat Kelantan Traditional**

According to (Spence, Smith, and Auvray, 2015)There is a distinction to be made between the term's "taste" and "flavour". Everyone has varied tastes, which impact the numerous facets of picking anything in everyday life. The flavour of traditional Malay food depends on traditional food production and the Malay community's acceptance of their location, even if the name or shape of the dish remains the same in principle (Sharif, Zahari, Nor, and Muhammad, 2013). The secret to creating uniquely flavorful Malay dishes is to use a wide variety of spices and other ingredients. The cooking equipment used in creating Malay traditional food is also a key component in distinguishing it from the traditional food of other state groups.

A family is a group that contributes to an important social norm for the young generation. According to Muhammad Shahrin Ab Karim (2015), when it comes to

nutrition, the family is the most important group that significantly affects how adolescents behave. It was shown from several previous studies that the result will vary depending on the structure of the family itself. The parents are typically the main factors in determining how their children will eat and will shape and determine that behaviour. There are two possible motivating factors for people to follow the eating norm (Higgs, 2015). Second, maintaining a healthy diet may be made easier by adhering to the rules. Malay traditional nutrition and practices for children begin at home since eating routines and practises learned as children must have the highest likelihood of remaining in place as adults (Bava et al., 2008; Kimura et al., 2010; Pedersen, Gronhoj, and Thogersen, 2015; Videon and Manning, 2003).

According to Daniels and Glorieux (2015) convenience is define as foods any fully or partially prepared foods whose preparation time, knowledge, culinary expertise, or energy inputs have been transmitted from the home kitchen to the food processor or other food distributors. In other words, both the transmission of culinary skills and the saving of time and energy are directly related to convenience meals. In addition, it seeks to simplify meal selection and preparation for the general public

### Research Hypothesis

- H1: There is a significant related between taste toward intention to eat Kelantan traditional food among UMK students at City Campus.
- H2: There is a significant related between family practice toward intention to eat Kelantan traditional food among UMK students at City Campus.
- H3: There is significant related between convenience toward intention to eat Kelantan traditional food among UMK students at City Campus.

### Research Framework

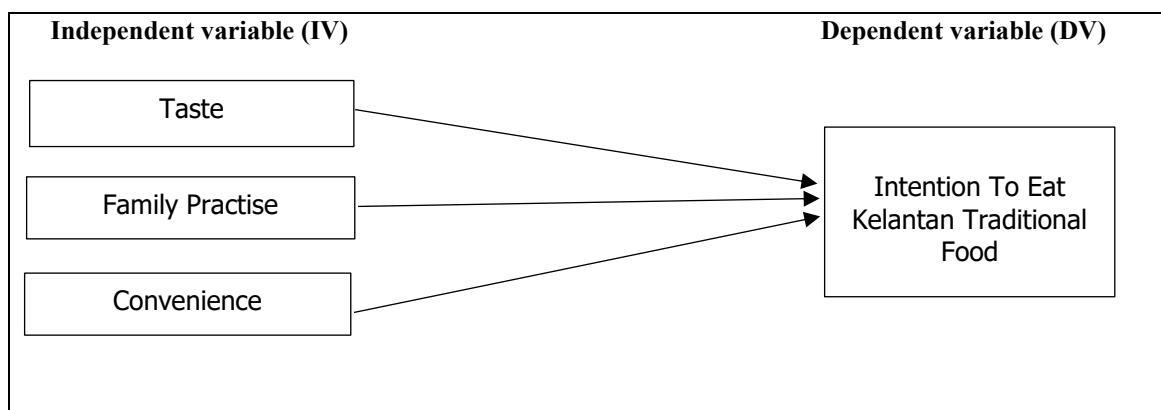

## METHODOLOGY

### Research Design

The research design is a strategy for logically connecting study components and ensuring effective problem-solving. This study aimed to determine if students at UMK City Campus intended to eat traditional food from Kelantan. Researchers used quantitative methods, including online surveys, to collect core data on taste, family practice, and convenience. The questionnaire-based survey included 361 students, utilizing mathematical and statistical methods to identify patterns and measure prevalence. The research design aimed to provide a methodical and transparent approach to addressing study issues.

### **Population and Sample Size**

UMK students at City Campus has a total population of 6775 students. The respondents are from various courses in UMK City Campus will participate in this research study. According to Krejcie and Morgan (1970), the sample size of 361 respondents will be determined in the study.

S = sample size

$X^2$  = the table value of chi-square for 1 degree of freedom at the desired confidence level (361)

N = the population size of students UMK at City Campus

P = the population proportion (assumed to be 0.5 since this would provide the maximum sample size)

d = the degree of accuracy expressed as a proportion (0.5)

The exact amount of sample size for the population are 361 but the return of the questionnaire answered by respondents collected the data for 361 respondents.

### **Sampling Method**

The method used to choose the subset of a population to participate in a study is called sampling. a technique for selecting many participants for a study in a way that makes sure they accurately reflect the big group from which they were selected. Two basic sampling approaches are used in the research. Non-probability sampling is a method for picking samples that are statistically reliable representations of a larger population. Non-probability sampling strategies choose participants based on their convenience, availability and whether they display a characteristic the researcher is interested in examining. For this analysis, the researchers used non-probability sampling procedures. The target demographic for the collection of samples was the younger generation. The samples were chosen at random by researchers from students UMK at City Campus from difference courses. Besides that, we use convenience sampling in conducting the research because it more suitable for this study.

## **Data Collection Procedure**

The study utilized a questionnaire to gather primary data from respondents about their plans to consume traditional food from Kelantan. A quantitative methodology was used, involving closed-ended and open-ended questions. The survey was divided into three parts: demographic information, Likert Scale, and dependent variable (DV). The third question, Part C, divided respondents' plans into taste, family practices, and convenience. The results will be made public to demonstrate students' desire to eat traditional Kelantan food.

## **DATA ANALYSIS**

Data analysis is the process of gathering, interpreting, and evaluating information to provide insights that may be used to make decisions. There are different ways and tactics for doing analysis, depending on the sector and the goal of the study. These methodologies are all founded on two types of study in both quantitative and qualitative research.

## **FINDINGS**

### **Result of Frequency Analysis**

#### **Demographics Profile of Respondent**

The frequency, percentage, and cumulative percentage were all included in this study's analysis. Questions about the respondents' gender, race, and state were among those from the questionnaire's Section A that provided the data.

Table 4.1 Statistic table on the (gender)

	<b>Frequency</b>	<b>Percent</b>	<b>Valid Percent</b>	<b>Cumulative Percent</b>
<b>Valid</b>	<b>Female</b>	<b>239</b>	<b>66.2</b>	<b>66.2</b>
	<b>Male</b>	<b>122</b>	<b>33.8</b>	<b>33.8</b>
	<b>Total</b>	<b>361</b>	<b>100.0</b>	<b>100.0</b>

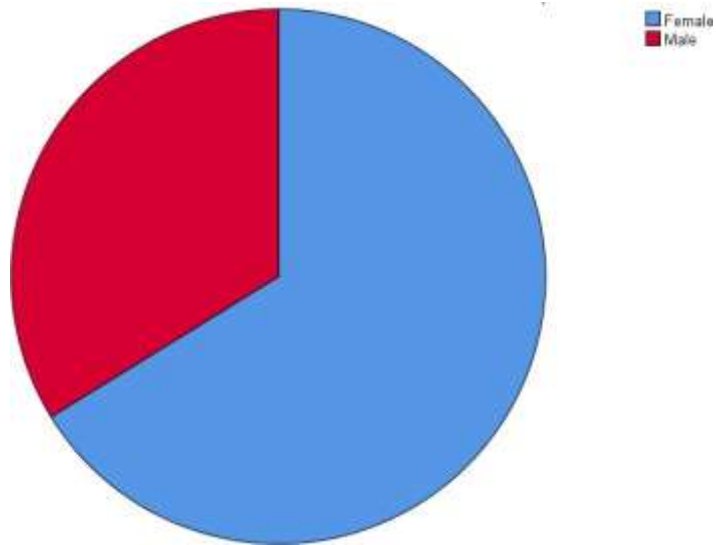

Figure 4.1 The percentage of gender

The percentage of male and female respondents was displayed in table 4.1 and figure 4.1 respectively. From the data, researcher found the majority of respondent is female for this survey. Male respondents only consist of 33.3% while female respondents consist of 66.2% respectively of the total respondents.

### The Number Of Race

Table 4.2 Statistic table on the (race)

		Frequency	Percent	Valid Percent	Cumulative Percent
Valid	Chinese	37	10.2	10.2	10.2
	Indian	31	8.6	8.6	18.8
	Malay	277	76.7	76.7	95.6
	Others	16	4.4	4.4	100.0
	Total	361	100.0	100.0	

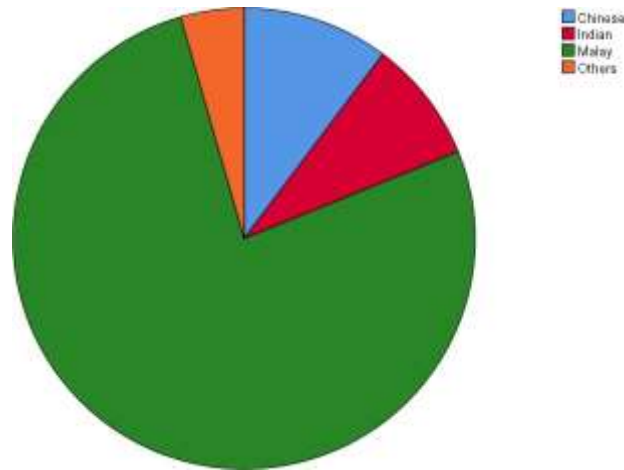

Figure 4.2: Percentage of race

Table 4.2 and figure 4.2 showed the percentage of the respondent based on race. From the total 361 respondents, the percentage shows that Malay was the higher with 76.7%, Chinese carry out with 10.2% while Indian 8.6% and others is 4.4%.

### The Data of State

Table 4.3: Statistic on the (State)

		Frequency	Percent	Valid Percent	Cumulative Percent
Valid	Johor	20	5.5	5.5	5.5
	Kedah	19	5.3	5.3	10.8
	Kelantan	161	44.6	44.6	55.4
	Kuala Lumpur	13	3.6	3.6	59.0
	Melaka	6	1.7	1.7	60.7
	Negeri Sembilan	4	1.1	1.1	61.8
	Pahang	37	10.2	10.2	72.0
	Penang	9	2.5	2.5	74.5
	Perak	11	3.0	3.0	77.6
	Perlis	4	1.1	1.1	78.7
	Sabah	14	3.9	3.9	82.5

Sarawak	6	1.7	1.7	84.2
Selangor	28	7.8	7.8	92.0
Terengganu	29	8.0	8.0	100.0

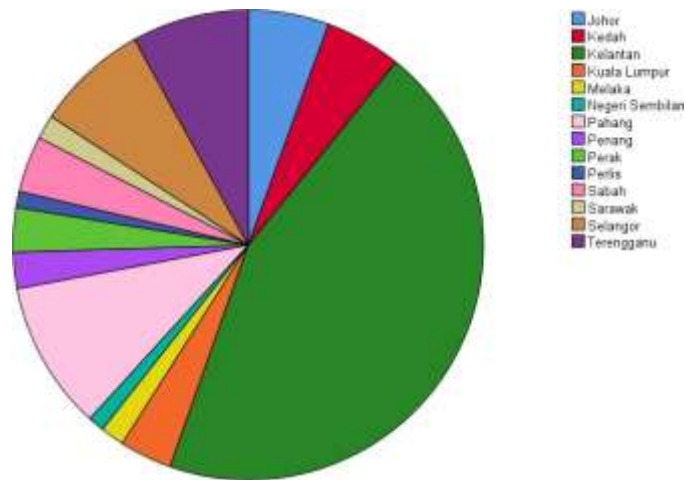

Figure 4.3: Percentage of state

Table 4.3 showed the percentage of the respondent based on the state. Based on the data frequency of 361 respondents, Kelantan are the majority respondents and follow by others state. From the total respondents of 14 state in Malaysia, the four highest score percentage is Kelantan itself with 44.6%, the second highest is Pahang with 10.2%, thirdly is Terengganu with 8.0%, next is Selangor with 7.8% and the rest of the percentage 29.4% are from others state.



### Result of Descriptive Analysis

Descriptive statistics indicate how the variables in Parts B and C of the survey were distributed on average. It aids researchers in fully comprehending the experiment or data supplied and provides all necessary context information.

#### Independent Variable (Iv1)

TASTE	MEAN	STANDARD DEVIATION
Question 1: Kelantan traditional food suits with my taste.	3.83	.959
Question 2: Kelantan traditional food contributes to my eating pleasure.	3.88	.923
Question 3: Kelantan traditional food is different from other states.	4.09	.824
Question 4: Kelantan traditional food has a good taste.	3.92	.906
TOTAL	3.9273	.77956

According to the table above, the questionnaire for Independent Variable 1 (IV1) contains four questions. The four involvement questions have a mean score that spans from 3.83 to 4.09. Question 3 received the highest score ( $M=4.09$  and  $SD=.824$ ), and 166 respondents said that they "agreed" with the survey's findings. Secondly is question 4 with the ( $M=3.92$  and  $SD=.906$ ) whereas 153 respondent "agreed" that taste of the food is good. Besides that, for question 2 with the ( $M=3.88$  and  $SD=.923$ ) whereas 152 respondent was "agreed" this food contribute their eating pleasure and the lowest is question 1 with the ( $M= 3.83$  and  $SD= .959$ ) whereas 150 respondents "agreed" that the food suit with their taste because majority of the UMK student is from Kelantan and followed by other respondents that come from other state that interested with the food that had a unique taste that set it apart from other states.

#### Independent Variable (IV2)

FAMILY PRACTISE	MEAN	STANDARD DEVIATION
Question 1: My family prepare a variety food of Kelantan traditional food.	3.36	1.263
Question 2: My family show how much they enjoy the traditional food of Kelantan.	3.73	1.063

Question 3: My family allow me to involve in preparing Kelantan traditional food.	4.00	.872
---	------	------

Question 4: My family encourage me to eat Kelantan traditional food.	3.83	1.011
TOTAL	3.7313	.91657

Based on the table above, there are four questions about independent variable 2 (IV2) in the evaluation. The mean score of the four questions in involvement ranges from the lower 3.36 until the highest 4.00. Question 3 with the (M= 4.00 and SD=.872) whereas the respondent chose “agreed” for this survey question, followed by the second highest score, question 4 with the (M=3.83 and SD= 1.011) whereas the respondents “agreed” that their family encourage them to eat Kelantan traditional food. Meanwhile, question 2 (M=3.73 and SD= 1.063) whereas the respondent was “agreed” that their family enjoy with this traditional food and the lowest score is question 1 with the (M= 3.36 and SD= 1.263) whereas the respondents “agreed” that their family also prepare a variety of Kelantan traditional food because most of the respondent come from Kelantan itself.

### Independent Variable (Iv3)

CONVENIENCE	MEAN	STANDARD DEVIATION
Question 1: Kelantan traditional food is easily to prepare.	3.63	1.000
Question 2: I can be bought in shop close that where I live or study.	4.24	.785
Question 3: Kelantan traditional food easily available in shop or supermarket.	4.06	.902
TOTAL	3.9760	.70975

According to the data in the table above, the third independent variable (IV3) questionnaire has three questions. The mean score of the three questions in involvement ranges from the lower 3.63 until the highest 4.24. Question 2 with the “M= 4.24 and SD= .785) whereas the respondent “agreed” that they can bought the Kelantan traditional food, followed by question 3 with the (M= 4.06 and SD= .902) where the respondent “agreed” with the question survey. The lowest is question 1 with the (M 3.63 and SD1.000) whereas the respondents “agreed” they have experience in preparing the traditional food especially with their family.

### Dependent Variable (DV)

INTENTION	MEAN	STANDARD DEVIATION
Question 1: I am satisfied with the overall quality of traditional Kelantan food.	3.95	.865
Question 2: I intend to purchase the food again in future.	3.95	.907
Question 3: The look and texture made me want to eat Kelantan traditional food.	3.99	.843
Question 4: I will promote about Kelantan traditional food to others.	4.16	.845
TOTAL	4.0104	.77955

There are the table of Dependent Variable (DV) for descriptive analysis. The mean score of the four questions of (DV) are involvement ranges from the lower 3.95 until the highest 4.16. The highest mean score is question 4 with the (M= 4.16 and SD= .845), followed by the second highest which is question 3 with the (M= 3.99 and SD .843) where the respondent “agreed” the look and texture influence them to eat the food and the rest of question are question 1 and question 2 got the same score which the Mean (3.95) but different standard deviation where the question 2 got S.Deviation (.907) and for question 1 (.865).

### Result of Reliability Analysis

For this survey, there were three independent variables and one dependent variable. The dependent variable is intention to eat Kelantan traditional food, and the independent variables are the taste of food, the family practice, and the convenience. Four questions were created for the dependent variable, and 11 were created for the independent variable.

Reliability Test	N	Cronbach’s Alpha	N Of Items
TOTAL	361	.948	15

According to the reliability results shown above, the researcher has checked all both dependent and independent variables. Cronbach's Alpha was 0.948 for all independent and dependent variables of reliability. The coefficient values of the variables

have been found to be excellent in terms of reliability level. The table below shows the Cronbach's Alpha rule of thumb for describing internal consistency.

### Result of Pearson Analysis

	Taste	Family practice	Convenience	Intention to eat Kelantan traditional food
Taste	1			
Family practice	0.814**	1		
Convenience	0.585**	0.629**	1	
Intention to eat Kelantan traditional food	0.819**	0.745**	0.631**	1

		<b>IV 1</b>
<b>DV</b>	Pearson correlation	.819**
	Sig. (2-tailed)	.000
	N	361

\*\* . Correlation is significant at the 0.01 level (2-tailed)

Table shows a significant relationship between taste (IV 1) and intention to eat Kelantan traditional food (DV) ( $r = 0.819$   $p < 0.01$ ). A correlation between taste and intention to eat Kelantan traditional food has been shown by the positive Pearson Correlation value of 0.819. At the same time, the 0.000 level of significance for both variables showed that they are highly significant, with a strong level of significance. The researcher concluded from the results that there is a positive relationship between taste and intention to eat Kelantan traditional food. As a result, the researcher accepted the alternative hypothesis and rejected the null hypothesis.

1 (2-tailed)

\*  
.  
C  
o  
r  
r  
e  
l  
a  
t  
i  
o  
n  
i  
s  
s  
i  
g  
n  
i  
f  
i  
c  
a  
n  
t  
a  
t  
t  
h  
e  
0  
.  
0  
1  
1

		<b>IV 2</b>
<b>DV</b>	Pearson correlation	.745**
	Sig. (2-tailed)	.000
	N	361

e  
v  
e

According to the table, there is a significant correlation between family practice(IV 2) and intention to eat Kelantan traditional food (DV) ( $r = 0.745$ ,  $p < 0.01$ ). The positive Pearson Correlation value of 0.745 indicates a correlation between familypractice and intention to eat Kelantan traditional food. At the same time, the 0.000 level of significance for both variables indicated that the two are both highly significant, with a moderate level of significance. As a result, the researcher accepted the alternative hypothesis and rejected the null hypothesis.

		<b>IV 3</b>
<b>DV</b>	Pearson correlation	.631**
	Sig. (2-tailed)	.000
	N	361

Correlation is significant at the 0.01 level (2-tailed)

According to the table, there is a significant correlation between convenience (IV 3) and the intention to eat Kelantan traditional food (DV) ( $r = 0.631$   $p < 0.01$ ). Convenience and intention to eat Kelantan traditional food was shown to be related by the positive Pearson Correlation value of 0.631. At the same time, the 0.000 level of significance for both variables indicated that both are highly significant, with a moderate level of significance. As a result, the researcher accepted the alternative hypothesis and rejected the null hypothesis.

## **DISCUSSION AND RECOMMENDATION**

This study aimed to determine the correlation between flavor and the desire of University of Malaysia (UMK) students to consume traditional food from Kelantan. It also examined the relationship between convenience and the intention to eat traditional food. The study involved 361 questionnaires and 361 respondents, with Cronbach's Alpha values ranging from 0.737 to 0.837. The results showed a moderately positive correlation between taste and the intention of UMK students to eat traditional Kelantan food ( $r = 0.819$ ,  $p < 0.01$ ), and a moderately positive correlation between family practice and the intention of UMK students to eat traditional Kelantan food ( $r = 0.745$ ,  $p < 0.01$ ). Convenience was also found to have a substantial positive link with the intention of UMK students to consume traditional food from Kelantan.

Future research should continue using quantitative approaches, such as Google Forms and online questionnaires, to improve respondents' understanding and save time. Additionally, qualitative studies could be considered for better realism and wider

applicability. Finally, future researchers could use interviews or open-ended questions to gather high response rates, better explanations, and better comprehension of respondents' viewpoints, potentially yielding superior research findings.

## **CONCLUSION**

Finally, a survey was conducted to ascertain the intention of UMK City Campus students to enjoy Kelantan traditional food. According to the study's findings, all independent criteria such as taste, family practice, and convenience influence people's inclination to consume Kelantan traditional meals. Consequently, students at the UMK City Campus represented the intention to enjoy traditional Kelantan food. Overall, the study's findings give vital insight into the link between Independent Variable and Dependent variables and demonstrate the need for future research in these areas of Kelantan traditional foods.



## REFERENCES

- Abdullah, K. M., & Azam, N. R. A. N. (2021). Innovated Malay Traditional Food Products: Do Consumers Accept the Authentic Quality? *International Journal of Academic Research in Business and Social Sciences*, 11(16), 199–208 <http://dx.doi.org/10.6007/IJARBS/v11-i16/11228>
- Akter, M., Sadekin, M. N., & Patwary, A. K. (2020). An Empirical Study on Students' Satisfaction from Mawlana Bhashani Science & Technology University, Bangladesh. *Review of Economics and Development Studies*, 6(2), 363-379.
- Almli, V. L. (2012). *Consumer acceptance of innovations in traditional food. Attitudes, expectations, and perception* (Doctoral dissertation, Norwegian University of Life Sciences).
- Alom, S., Patwary, A. K., & Khan, M. M. H. (2019). Factors affecting the turnover intention of Bangladeshi migrants in the United Arab Emirates: An empirical study on the hotel industry. *International Journal of Innovation, Creativity and Change*, 8(3), 344-360.
- Bhandari, P. (2020, June 5). Data Collection | Definition, Methods & Examples. Scribbr. Retrieved January 6, 2023, from <https://www.scribbr.com/methodology/data-collection/>
- Cheng, L. W., Samsudin, M. N., Nor, N. N. M., Makhtar, N. A. A., & Othman, N. A. (2020). Factors That Affecting Generation Y Customers' Preferences towards Kuih Akok. *NURTURING HOSPITALITY, TOURISM AND WELLNESS WORLD*, 49.
- Creswell, John. (2009). *Research Design: Qualitative, Quantitative, and Mixed-Method Approaches*.
- Current population estimates, Malaysia, 2021. favourite { position : Absolute; width : 24px; height : 24px; background : URL(IMAGES/ICON/FAV-PUB-GRAY.PNG) no-repeat; top : 0px; right : 0; } .added { background : Url(images/icon/fav-pub-yellow.png)
- David, W., & Darwin, C. (2014). Perception of young people toward their traditional food. *Asia Pacific Journal of Sustainable Agriculture, Food and Energy*, 2(2), 32-35.
- Fengmin, Z., Baijun, W., Jiangtao, B., Li, L., & Patwary, A. K. (2022). Investigating revisit intention of medical tourists in China through nutritional knowledge, perceived medical quality, and trust in the physiologist: A recommendation on health tourism policy measures. *Frontiers in Public Health*, 10, 893497.
- Hamzah, H., Ab Karim, M. S., Othman, M., Hamzah, A., & Muhammad, N. H. (2015). Challenges in sustaining the Malay Traditional Kuih among youth. *International Journal of Social Science and Humanity*, 5(5), 472.
- Hazbar, A. M. H., Alem Mohammed, A., & Karim, A. K. A. (2019). An Empirical Study of Factors Influencing hotel customers' online booking Intention. *مجلة العلوم التربوية و الدراسات الإنسانية*, (5), 1-17.
- [https://www.dosm.gov.my/v1/index.php?r=column%2FcthemByCat&cat=155&amp;bul\\_id=ZjJOSnpJR21sQWVUcUp6ODRudm5JZz09&menu\\_id=L0ph](https://www.dosm.gov.my/v1/index.php?r=column%2FcthemByCat&cat=155&amp;bul_id=ZjJOSnpJR21sQWVUcUp6ODRudm5JZz09&menu_id=L0ph)

- Introduction: The Importance of Traditional and Ethnic Food in the Context of Food Safety, Harmonization, and Regulations. (2015, December 4). Introduction: The Importance of Traditional and Ethnic Food in the Context of Food Safety, Harmonization, and Regulations - ScienceDirect. Retrieved January 6, 2023, from <https://www.sciencedirect.com/science/article/pii/B9780128006054000013>
- Kuhnlein, H. V., & Receveur, O. (1996). Dietary change and traditional food systems of indigenous peoples. *Annual review of nutrition*, 16(1), 417-442.
- Li, L., Ragavan, N. A., Patwary, A. K., & Baijun, W. (2022). Measuring patients' satisfaction toward health tourism in Malaysia through hospital environment, nutritional advice, and perceived value: A study on Chinese exchange students. *Frontiers in public health*, 10, 893439.
- Li, L., Wu, B., & Patwary, A. K. (2022). How marine tourism promote financial development in sustainable economy: new evidences from South Asia and implications to future tourism students. *Environmental Science and Pollution Research*, 29, 1155-1172.
- Li, L., Wu, B., & Patwary, A. K. (2022). The psychosocial factors affecting chinese Outbound Exchange and mobility students' academic performance during COVID-19. *Frontiers in psychology*, 13, 872516.
- McCombes, S. (2019). Sampling Methods | Types, Techniques & Examples. Scribbr. Retrieved January 6, 2023, from <https://www.scribbr.com/methodology/sampling-methods/>
- Monteleone, E., Spinelli, S., Dinnella, C., Endrizzi, I., Laureati, M., Pagliarini, E., Sinesio, F., Gasperi, F., Torri, L., Aprea, E., Bailetti, L. I., Bendini, A., Braghieri, A., Cattaneo, C., Clicerri, D., Condelli, N., Cravero, M. C., Del Caro, A., Di Monaco, R., ... Tesini, F. (2017). Exploring influences on food choice in a large population sample: The Italian Taste project. *Food Quality and Preference*, 59, 123-
- Muhammad, N. H., Ab Karim, M. S., & Hamzah, H. (2015). Intention to eat traditional food among boys and girls in Malaysia. *International Journal of Social Science and Humanity*, 5(5), 450.
- Nasir, S., Musdi, A., Kobu, K., & Zali, Z. (2021). Factors That Influence the Acceptance of Millennial Generation to Consume Traditional Food (Kuih-Muih) In Kota Bharu. *RESEARCH TOWARDS IR 4.0*, 131.
- no-repeat; }. Department of Statistics Malaysia Official Portal. (n.d.). Retrieved January 7, 2023, from
- Patwary, A. K., Roy, B., Hoque, R., & Khandakar, M. S. A. (2019). Process of developing a community based tourism and identifying its economic and social impacts: An Empirical study on Cox's Bazar, Bangladesh. *Pakistan Journal of Humanities and Social Sciences*, 7(1), 1-13.
- Perry, M. S. (2017). Feasting on Culture and Identity: Food Functions in a multicultural and transcultural Malaysia. *The Southeast Asian Journal of English Language Studies*, 23(4), 184-199. <https://doi.org/10.17576/312017-2304-14>
- Rahman, S. A. G., Ab Karim, S., Ishak, F. A. C., & Arshad, M. M. (2018). Understanding the Young Generations' Preference Towards Malay

- Traditional Food in Malaysia. *Journal of Tourism*, 3(9), 42-57.
- Rahman, S. A. G., Ab Karim, S., Ishak, F. A. C., & Arshad, M. M. (2018). Understanding the Young Generations' Preference Towards Malay Traditional Food in Malaysia. *Journal of Tourism*, 3(9), 42-57.
- Rahmat, N., Ramlan, M. N., Ghazali, P. N. A., & Ngali, N. (2021). Intention to Eat Traditional Food among University Students.
- Ravikiran. A. S. (2021). Population vs Sample: Definitions, Differences and Examples. Retrieved from <https://www.simplilearn.com/tutorials/machine-learning/tutorial/population-vs-sample>
- Robert V. Krejcie, D. W. M. (1970). Determining sample size for research activities. *Educational and psychological measurement*, 30. Retrieved from [https://home.kku.ac.th/sompong/guest\\_speaker/KrejcieandMorgan\\_article.pdf](https://home.kku.ac.th/sompong/guest_speaker/KrejcieandMorgan_article.pdf)
- Sumethokula, P., Patwary, A. K., Srinuanpanc, B., Srinuanpand, C., Suwandee, P., Thammathikul, A., & Phanong, W. (2020). The potential of new tour repackaging for creative tourism among entrepreneurs in Nakhon Si Thammarat. *International Journal of Innovation, Creativity and Change*, 13(10), 1752-1771.
- Tan, A. L., & Yow, T. O. (2016). Motives for millennials' choice on traditional food and their level of consumption: A cross-cultural comparison.
- Tavakol, M., & Dennick, R. (2011). Making sense of Cronbach's alpha. *International journal of medical education*, 2, 53.
- Tomić, M., Deronja, K., Kalit, M. T., & Mesić, Ž. (2018). Consumers' attitudes towards ethnic food consumption. *Journal of Central European Agriculture*, 19(2), 349-367. <https://doi.org/10.5513/jcea01/19.2.1992>
- Wu, B., Liu, S., Wang, J., Tahir, S., & Patwary, A. K. (2021). Assessing the mechanism of energy efficiency and energy poverty alleviation based on environmental regulation policy measures. *Environmental Science and Pollution Research*, 28, 40858-40870.
- Wu, B., Zhai, B., Mu, H., Peng, X., Wang, C., & Patwary, A. K. (2021). Evaluating an economic application of renewable generated hydrogen: A way forward for green economic performance and policy measures. *Environmental Science and Pollution Research*, 1-15.

# CUSTOMER SATISFACTION TOWARDS SERVICE QUALITY IN THE FAST-FOOD INDUSTRY AT KOTA BHARU, KELANTAN

**Nur Farah Syahida Binti Mohd Sudirman, Nur Fatin Husnina Binti Mohd Nazri,  
Nur Hashimah Binti Ab Ghani, Nur Hidayah Binti Zahari & Nur Dalila Binti Mat  
Yusoff**

*Faculty of Hospitality, Tourism and Wellness, Universiti Malaysia Kelantan*

*Corresponding email: nurdalila@umk.edu.my*

---

## ABSTRACT

*Customer satisfaction is one of the most important aspects of any business, particularly in the fast-food industry. Because of market competition and the abundance of firms, an organization must prioritize the degree to which a consumer is satisfied with the organization's products and services. The purpose of this research is to aim customer satisfaction towards the service quality in the fast-food industry at Kota Bharu, Kelantan. Clarifying the significance of service quality in customer satisfaction is the study's main goal. An organized questionnaire will be utilized to gather the majority of the study's data, and SPSS Version 20 was used for analysis. Through the use of social media, online questionnaires were used to contact the participants and collect data. 384 randomly selected individuals from Kota Bharu, Kelantan, were given the survey to complete. The findings indicate a favorable correlation between customer happiness and service quality in Kota Bharu, Kelantan's fast-food industry.*

Keywords: Customer Satisfaction, Service Quality, Fast-food industry, Social Media.

---

## INTRODUCTION

The sensation of pleasure and expectation fulfilment, according to Zairi (2000), is what is meant by the term satisfaction. If a customer's needs aren't met by a product, they'll be unsatisfied; yet, if they are, they will be happy with the product or brand and stay loyal to it. The word "customer satisfaction" refers to the degree to which a company's products or services meet or exceed the needs of its customers. It is among the most important determinants of customer loyalty and purchase intention.

Customer happiness, according to Oliver (1981), is a part of marketing and has a significant impact on the market. Customer pleasure was not always respected, and quality was not as important. However, due to education and learning environments, customers are now taught about the competition and are aware of all products and businesses. As a result, every firm is concerned with correctly meeting its customers' needs and wants.

Fast food is an economical, quick, accessible, and convenient substitute for home-cooked meals, according to the National Institutes of Health (NIH). They also have a lot of calories, sugar, salt, and saturated fat. The way of life of people in Kota Bharu, Kelantan, has substantially benefited the fast-food business lately.

There are three objectives of this research:

1. To identify the relationship between tangible in service quality towards customer satisfaction in the fast-food industry.
2. To analyze the relationship between tangible in service quality towards customer satisfaction in the fast-food industry.
3. To explore the relationship between responsiveness in service quality towards customer satisfaction in the fast-food industry.

### **Significance of the Study**

Worldwide, the fast-food industry has become extremely profitable. Good service quality contributes to client happiness and increases the firm's market competitiveness. The goal of this research is to explain how tangible factors such as responsiveness and assurance affect customer satisfaction at fast-food restaurants in Kota Bharu, Kelantan. The study's significance for the community is to achieve consumer happiness, which leads to company loyalty and product repurchase. Customers will acquire things that are worth their money and will perceive the purchase to be worthwhile. Not only that, but the findings of this study can be used to help new fast-food restaurant owners develop their enterprises.

Furthermore, the government can use the findings of this study to enhance fast food and encourage Malaysia's economy in the future. Malaysia's GDP can be expanded in the long run, leading to tremendous expansion in the fast-food business.

## **LITERATURE REVIEW**

### **Customer Satisfaction in the Fast Food Industry**

The extent to which products, services, and interactions with customers live up to expectations is viewed as a positive influence in the fast-food sector. Enjoyment and wellbeing are components of customer satisfaction. By comparing the level of performance, quality, or other results that the user encounters to an assessment criteria, one can determine how much of a user experience generates positive feelings. Customer satisfaction is calculated by comparing the level of performance, quality, or other results that the user experiences to an evaluation criteria. Customer satisfaction is a result of a product meeting the needs, aspirations, and expectations of the customer (Yuniarti 2015).

Businesses may attract customers and gain their loyalty by providing high-quality products and services. One of the company's important goals to reach in order to win back customers is customer

satisfaction (Han 2019). Customers who are happy with a product are more likely to repurchase it and stick with it. They are less price sensitive and can positively influence other customers by recommending it to them.

### **Tangible**

Tangible reduces the customer's risk and ambiguity while assessing the quality of the offering (Miller and Foust, 2003). In the literature on marketing, for instance, emphasis has been placed on researching the tactics that marketers might use to improve customers' perceptions of the tangibility of their experiences.

The definition of tangible is the physical features of the service being provided. It includes the menu's appearance and design as well as attire (Kassie,2017). In contrast, (Akroush,2015) the research shows that all observable elements of service quality should receive special consideration because they affect customer loyalty and have the potential to boost business profits. To ensure the smooth operations of the fast food industry they should have a clear plan and employ a particular strategy while carrying out facility maintenance.

### **Responsiveness**

Responsiveness, ability to help customers, and good services. Response time is still necessary even if the customer declines to contact you. Respond as soon as you can to at least inform the client that their request is being processed. Being responsive can show your clients that you care about their issue and are actively looking for a solution. (Feriors, 2021) Responsive to customers' needs makes them feel at ease, impresses them, and focuses their attention on the specific fast-food industry. However, customer responsiveness is highly valued and will provide any fast-food firm an advantage over its rivals and other market participants.

### **Assurance**

Monitoring the caliber of customer interactions is known as customer service quality assurance. They may measure and enhance the performance of your team and the entire support process by conducting regular conversation reviews. Making it simple to please consumers is a key component of customer service quality assurance. When 50% of customers think that the customer experience is more important to them now than it was a year ago, making customers happy should be a top priority.

## **Relationship between Tangible, Responsiveness and Assurance Towards Customer Satisfaction in Fast Food Industry**

## **Tangible**

The five categories of tangible property used in the fast food industry are: items, furniture and fixtures, electronic equipment, signage, and packaging. Customer satisfaction with the fast-food restaurant's service quality industry is very important to improve their company to higher quality. Everyone's first sight when they come to the fast-food industry is the physical look of buildings, machinery, people, and communication tools or tangibility. When everything looks good, customers will be happy to go around to the company. Besides, well-groomed and tidy workers in producing products also influence customer satisfaction either positively or not. The customer's priority is that the things they want and need are guaranteed in all respects, especially cleanliness and quality. Therefore, paying attention to appearance is the most important thing to looking up the values of consumer comfort.

## **Responsiveness**

The term "responsiveness" refers to a service provider's capacity to assist customers and offer prompt service. This illustrates the staff's propensity for timely and effective programme delivery. Previous studies have shown that being responsive means being ready to help customers and offer quick service. It is a process-established logically formed, defined, and clarified association connectivity among variables considered important to the problem situation. Every fast-food industry must be responsive toward customers in giving satisfaction to them. These fast-food industries are prepared in a short time and of course, customers need fast delivery service. Staff must respond to the customers' issues and complaints immediately, especially in a hectic environment.

In another case, if customers are hesitant to respond, staff must still be responsive. For example, after an order is taken, staff must respond as soon as possible to inform customers that their request is being processed. This can show the clients that the company cares about their problems and is actively seeking solutions by being responsive. So, it will increase customer satisfaction by being responsive throughout the work.

## **Assurance**

Customers will be satisfied when you offer them safe, high-quality products, and this will definitely lead to good reviews, a rise in demand, more sales, and more profits. On the other hand, poor quality can lead to complaints and permanent harm to one's reputation. A business runs less of a chance of being the target of scandals, bad news, and complaints if it can constantly guarantee quality. Employee knowledge, politeness, and the capability to inspire confidence or assurance are necessary for the fast-food industry. This is because customers consider the company that has assurance as a high performer in providing their services.

Customers place their trust in assurance because they have many options when making a purchase. For example, if they want to buy something online but no assurance is provided, they run the risk of being duped. Thus, customers will be satisfied after they know about the company's assurance.

## **Hypothesis**

In accordance with the conceptual framework, the independent variables for this study were service quality in tangibility, assurance, and responsiveness of the fast-food industry. There are three independent variables that have been presented. Customer satisfaction is the dependent variable.

Hypothesis 1: There is a relationship between the tangibility in service quality towards customer satisfaction in the fast-food industry.

Hypothesis 2: There is a relationship between the responsiveness in service quality towards customer satisfaction in the fast-food industry.

Hypothesis 3: There is a relationship between the assurance in service quality towards customer satisfaction in the fast-food industry.

### Research Framework

The conceptual framework for this research is seen in Figure 1. The three factors that make up the independent variables that will be proposed are tangible, responsiveness and assurance. Customer satisfaction is the dependent variable.

Figure 1 : Conceptual Framework of the relationship between tangible, responsiveness and assurance with customer satisfaction.

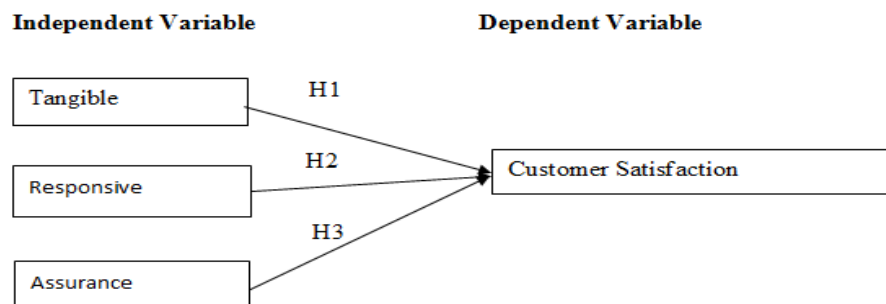

## METHODOLOGY

### Research Design

The design of the study considers the variables that affect the dedication of fast-food industry services. In this study, a self-directed questionnaire will be used to collect data from participants



utilizing a quantitative methodology. A descriptive study on the connection between tangible, assurance and responsiveness for the fast-food industry can be considered.

### **Population and Sample Size**

Malaysia has a total population of 32.7 million people living there. Kelantan's overall population is expected to be 1,792,501 in 2020. This study's research population is limited to Kota Bharu, Kelantan. Kota Bharu has a population of 555,757 people. In this investigation, the Krejcie and Morgan (1970) sample was used to calculate sample size. Morgan and Krejcie (1970):

S = sample size

$X^2$  = the table value of chi-square for 1 degree of freedom at the desired confidence level (3.841)

N = the population size of domestic tourist in a year

P = the population proportion (assumed to be 0.5 since this would provide the maximum sample size)

d = the degree of accuracy expressed as a proportion (0.5)

The exact amount of sample size for the population is 384 and the return of the questionnaire answered by respondents collected the data for 384 respondents.

### **Data Collection**

In the first stage, the data collection method that had been used in this study is online surveys that used Google form. The reason why the researcher used this platform of technology tools is because it is free and friendly to users. It also makes it easier for the researcher to collect all the data from the local population. The second stage of data collection was fieldwork. In this study, questionnaires also had been used as the instrument for primary data collection. There are 5 parts of the section that respondents need to answer. The questionnaire was distributed to the population to collect the data, which is the local population in Kota Bharu, Kelantan.

In the first stage, the data collection method used in this study was online surveys using Google forms. The researcher chose this platform of technology tools because it is free and user-friendly. It also makes collecting data from the local populace easier for the researcher. Fieldwork was the second stage of data collecting. In this study, questionnaires were also used as the primary data gathering instrument. The section requires respondents to answer five inquiries. The questionnaire was distributed to the local populace in Kota Bharu, Kelantan, in order to collect data.

### **Sampling**

Sampling is a technique for obtaining data in academics to learn regarding a particular population by studying the findings of a sample of people rather than focusing on some specific individuals (Turner, 2020). Probability sampling and non-probability sampling are the two major sample methodologies used in this study. Random samples are used in probability sampling, enabling

important inferences more about overall demography to be drawn (Stratton, 2021). Non-probability sampling is frequently related with qualitative research and the construction of research articles (Taherdoost, 2016). The non-probability approach, for example, a simple sampling method, was chosen as the sample design in this investigation.

Facility sampling is a non-probability or non-random sampling strategy in which participants from a target group who satisfy the study's requirements, such as easy accessibility, geographic location, capacity at a given time, or desire to participate, are included (Etikan et al., 2016)

## Research Instrument

Table 1: Overview of Research Instrument

Sections	Variables	Item	Authors
A	Demographic profile	6	Omar, Juhdi, Ahmad & Nazri (2014)
B	Tangible	5	A Parasuraman, Valarie A Zeithaml, L Berry 1988 64 (1), 12-40, 1988;
	Responsiveness	5	Parasuraman, Zeithaml, and Berry (1988)
	Assurance	5	Cronin J. Joseph Jr. and Taylor Steven A. (1992)
C	Customer satisfaction	5	Pizam A, Shapoval V, Ellis T (2016)

## Data Analysis

Researchers used the Statistical Programmers for Social Science (SPSS) version 20 to examine the primary data. SPSS is a program-based data processing and analysis window that allows you to create tables and pie charts. Computers aided researchers in lowering the effort required to determine information and making quantitative analysis easily and quickly. The researcher uses descriptive statistics, reliability statistics, Pearson's correlation, and regression to evaluate quantitative data.

## FINDINGS

### Result of Frequency Analysis

Tabel 2 shows the results of the frequency analysis

Table 2 : Frequency Analysis

---

<b>Respondent Profile</b>	<b>Classification</b>	<b>Frequency</b>	<b>Percentage</b>
		<b>n = 384</b>	<b>(%)</b>
<b>Gender</b>	Male	161	41.9
	Female	223	58.1
<b>Age</b>	18 – 25	134	34.9
	26 – 35	104	27.1
	36 – 40	87	22.7
	41 and above	59	15.4

---

---

<b>Status</b>	Married	164	42.7
	Single	190	49.5
	Others	30	7.8
<b>Race</b>	Malay	215	56
	Chinese	83	21.6
	Indian	57	14.8
	Others	29	7.6
<b>Frequency of customer visit at fast food restaurant</b>	Once a week	101	26.3
	2 – 3 times a week	89	23.2
	More than 3 times in a week	53	13.8
		141	36.7
	Once a month		

---

A total of 384 respondents were gathered for this study. From Table 2, there are 161 (41.9%) respondents representing men, and 223 (58.1%) respondents representing women. It demonstrates that there were more female respondents in this study than there were male respondents. Age is divided into 4 categories. A total of 134 (34.9%) respondents, or the majority of the sample, are

between the ages of 18 and 25. Meanwhile, there are 104 (27.1%) respondents who are under the age of 26-35 years. Next, there are 87 (22.7) respondents in the age range of 36 - 40 years. Finally, there are only 59 (15.4%) respondents in the age range of 41 and above years. Overall, 190 (49.5%) respondents are single, which represents the majority of respondents. Meanwhile, the respondents who are married are 164 (42.7%). Married respondents showed a total of 30 (7.8%) respondents who chose others not to tell their status. Next, the majority of respondents were reported to be Malay, totaling 215 (56%) respondents. For the Chinese and Indians, 83 (21.6%) respondents and 57 (14.8%) respondents respectively. Meanwhile, only 29 (7.6%) respondents reported being of a different race than Malay, Chinese or Indian. The table shows that among all the frequency groups of customers visiting fast food restaurants, respondents who visit fast food restaurants once a month are the highest, which is 141 (36.7%) respondents. A total of 101 (26.3%) respondents, or the second highest group, report eating out once every week. 2–3 times a week is the frequency of fast food restaurant visits reported by 89 respondents (23.2%). 53 (13.8%) respondents, representing a portion of the sample, reported eating at fast food establishments more than three times per week.

## Result of Descriptive Analysis

The findings of the descriptive analysis are shown in Table 3.

Table 3: Descriptive Analysis

Variables	Statement	Mean	SD
<b>Tangible</b>	Is it easy for customers to park their vehicles in the parking lot provided?	4.49	0.719
	Are the toilets provided by the restaurant well maintained?	4.32	0.782
	Does the restaurant provide a comfortable place to eat for customers?	4.44	0.614
	Do fast food restaurants provide clean food to customers?	4.41	0.684
	Is the displayed menu list easy for customers to understand to order food?	4.49	0.587
	Does the process of ordering food save the customer's time?	4.37	0.677

<b>Assurance</b>	Do customers feel comfortable dealing in fast food restaurants?	4.50	0.600
	Are customers confident to order food at a fast food restaurant?	4.37	0.608
	Do customers feel safe making payment transactions at fast food restaurants?	4.35	0.661
	Are employees at fast food restaurants always polite to customers?	4.30	0.751
	Do employees follow the correct SOP as an employee at a fast food restaurant?	4.32	0.751
	Do fast food restaurant employees have good knowledge to answer customer inquiries?	4.32	0.662

<b>Responsive</b>	Can part-time workers in fast food restaurants help maintain the speed of service to customers?	4.52	0.625
	Can part-time workers in fast food restaurants help maintain the quality of service to customers?	4.40	0.614
	Are workers in fast food restaurants sensitive to customer needs?	4.34	0.741
	Will the workers at the fast food restaurant be able to meet the demands of the customers?	4.41	0.648
	Did the customer receive the food order within the specified time?	4.40	0.734
	Are customers satisfied with the service provided by the fast food restaurant?	4.40	0.621
<b>Customer Satisfaction</b>	Are customers satisfied with the problem-solving approach made by fast food restaurant employees?	4.50	0.697
	Is the time taken by employees very efficient in solving customer problems?	4.36	0.664
	Are employees quick to respond to customer problems?	4.36	0.691
	Do employees provide good customer service?	4.38	0.630

The results of the survey with 834 respondents' mean values and standard deviations for each variable are shown in Table 3. Question 1 and Question 5 had the highest mean scores for tangible, which was the first independent variable, with  $M=4.49$  and  $SD=0.719$  and  $0.587$  respectively. Given a score of ( $M=4.32$ ,  $SD=0.728$ ), question 2 had the lowest mark. According to the assurance



score for the second independent variable, question 1 had the greatest mean score ( $M=4.50$ ,  $SD = 0.600$ ), and question 4 had the lowest mean score ( $M=4.30$ ,  $SD = 0.751$ ). The item with the highest mean score for the third independent variable, responsiveness, was question 1, which had a mean score of ( $M=4.52$ ,  $SD=0.625$ ). Responsive received the lowest mean score for this ( $M=4.34$ ,  $SD=0.741$ ), nevertheless. Finally, the greatest mean score for the dependent variable for customer satisfaction question 1 was ( $M=4.50$ ,  $SD=0.697$ ) and the lowest mean scores were ( $M=4.36$ ,  $SD=0.691$ ) and ( $M=4.36$ ,  $SD=0.664$ ) for questions 2 and 3, respectively. In a fast food restaurant in Kota Bharu, Kelantan, the respondents who agreed on the dependent variable and dependent variable were the ones who influenced customer satisfaction.

### **Result of Reliability Analysis**

The reliability analysis's findings are displayed in Table 4 below.

Table 4: Reliability Analysis

<b>Variables</b>	<b>Cronbach's</b>	<b>Alpha</b>	<b>N of Items</b>
<b>Tangible</b>	0.852		6
<b>Assurance</b>	0.861		6
<b>Responsive</b>	0.858		6
<b>Customer Satisfaction</b>	0.858		4

Results of the reliability analysis are shown in Table 4. An assurance score of 0.861, a responsive score of 0.858, and a customer happiness score of 0.858 for fast food restaurants follow Tangible, which has a Cronbach Alpha of 0.852. Because of this, the questionnaire is trustworthy and appropriate for use in research.

## Result of Pearson Correlation Analysis

The results of the Pearson correlation analysis are shown in Table 5 below.

Table 5: Pearson Correlation Analysis

Hypothesis	p-Value	Result (Support/ Not Supported)
<b>H1: There is a significant relationship between tangible service quality towards customer satisfaction in the fast food industry.</b>	0.100	H1 is supported
<b>H2: There is a significant relationship between assurance in service quality towards customer satisfaction in the fast food industry.</b>	0.669	H2 is supported
<b>H3: There is a significant relationship between responsiveness in service quality towards customer satisfaction in the fast food industry.</b>	0.531	H3 is supported

Based on Table 5, it can be seen that Pearson's correlation analysis was used to assess the customer satisfaction hypothesis with the level of service quality in the fast food industry in Kota Bharu, Kelantan. All offered hypotheses were accepted at the 0.01 level of significance. Additionally, the conclusion demonstrated that tangible, assurance, and responsiveness, three independent factors, had a very strong and high positive association with customer satisfaction, supporting the entire hypothesis.

## DISCUSSION & RECOMMENDATION

### Discussion

This study's major goal is to identify and evaluate the connection between customer happiness and service quality in the fast-food sector. It has been discovered that customers are happy when they express a desire to frequent the fast food establishment again and a readiness to order food there frequently. According to the research, optimism is significantly correlated with existence, responsiveness, assurance, and customer happiness. Additionally, clients will be pleased if they believe that the meal they purchased was worth the money they paid for it. This is because they

frequently take price into account while making great-quality purchases. Therefore, service providers must ensure that they deliver excellent service quality to ensure that customers have a better experience, which can increase customer happiness. Customers at fast food restaurants in Kota Bharu receive a similar level of service, ensuring that those who have already eaten there won't recall anything different. In order to fulfill clients' requirements and desires, it is crucial for service providers to offer them high-quality services.

### **Research implication**

The results of the study indicate that user happiness is most influenced by service quality. The study's consequence is that restaurant owners should be motivated to provide good service quality for the price of their menu items. This is due to the fact that this study's findings indicate that tangible, assured, and prompt service is the most important factor influencing customer happiness. In order for all customers to enjoy purchasing the goods, fast food businesses must uphold and provide good service to patrons. Furthermore, it could convince consumers that the item they are purchasing is worth their money. In order to compare products with those of other brands' competitors, consumers must consider excellent service.

### **Research Limitation**

There are a few restrictions on how this analysis can be done. As a result of only being done in the Kota Bharu region, the study had some limitations. Due to the extensive scope of the research, the researchers must put in more effort and use their time more effectively in order to finish the project on schedule.

Then, limited access to journals and articles related to that topic. This is because some databases must pay to approach the articles that help with this research. Although, it was beyond the capabilities of a student. Moreover, there are only a few local articles linked to this subject published so this report needs to depend more on overseas articles.

Respondents who refused to answer the questionnaire. The researcher used a Web-based survey questionnaire. The researcher spread the google form link via. But not everyone cares to answer that question. Maybe because of a busy daily schedule or maybe there are people from multiple races who don't understand Malay. This has resulted in several respondents misunderstanding or misinterpreting the survey questionnaire.

### **Research Recommendations.**

There are several research recommendations to improve this study for the benefit of future studies. First, future researchers are recommended to expand the study area where it is necessary to cover two places and maybe the researcher can make methods like face-to-face interviews that may allow respondents to be more involved and get a deeper insight from them for the study.

Moreover, future researchers need to learn technical skills to get free access to journals and articles. Future researchers must learn technical skills to gain free access such as attending seminars. Not only that, future researchers are suggested to provide language diversity in the questionnaire. The

survey instrument is available in Malaysian. In order to collect a more diverse sample, survey instruments may be designed in several languages such as English, Mandarin and Tamil. As Kelantan is a multi-racial country, a collection of responses from various ethnic groups will give more realistic results. This will help the respondents to understand all the questions carefully and provide more reliable results.

## CONCLUSION

The fast food restaurant needs to look clean, is in a strategic location, serves high quality food and operates at the right time. In addition, fast and quick service, comfortable seating facilities, reliable delivery services and fast-food operators are performing well in providing new food for children. Although these attributes are seen positively, respondents still see other attributes such as price, friendliness, variety of menu and calorie/nutrition content as moderate qualities. The choice of a fast food restaurant is determined by the cleanliness of the restaurant and the menu items.

The findings of this study are discussed extensively in this chapter. Next, this chapter summarizes the tasks completed in this research by reporting the hypothesis test, answering the research questions and achieving the objectives of the research. Additionally, this chapter also outlines some limitations and recommendations. This study concludes with the contribution of the study and some recommendations for next research.

## REFERENCES

- Akter, M., Sadekin, M. N., & Patwary, A. K. (2020). An Empirical Study on Students' Satisfaction from Mawlana Bhashani Science & Technology University, Bangladesh. *Review of Economics and Development Studies*, 6(2), 363-379.
- Al Mahmud, S. R. (2020). The effectiveness of Facebook advertisements on purchase intention of customers in Malaysia. *South Asian Journal of Social Sciences and Humanities*, 1(1), 97-104.
- Alom, S., Patwary, A. K., & Khan, M. M. H. (2019). Factors affecting the turnover intention of Bangladeshi migrants in the United Arab Emirates: An empirical study on the hotel industry. *International Journal of Innovation, Creativity and Change*, 8(3), 344-360.
- BAKSHI, P. (2021, April 28). Descriptive Statistics. Nerd for Tech. <https://medium.com/nerd-for-tech/descriptive-statistics-81c9dce06da0>
- Department of Statistics Malaysia Official Portal. (2020). [Www.dosm.gov.my. https://www.dosm.gov.my/v1\\_/](https://www.dosm.gov.my/v1_/)
- Fengmin, Z., Baijun, W., Jiangtao, B., Li, L., & Patwary, A. K. (2022). Investigating revisit intention of medical tourists in China through nutritional knowledge, perceived medical quality, and trust in the physiologist: A recommendation on health tourism policy measures. *Frontiers in Public Health*, 10, 893497.
- Fida, B. A., Ahmed, U., Al-Balushi, Y., & Singh, D. (2020). Impact of Service Quality on Customer Loyalty and Customer Satisfaction in Islamic Banks in the Sultanate of

- Oman. SAGE Open, 10(2), 215824402091951.  
<https://doi.org/10.1177/2158244020919517>
- Giofani Eka, M. (2019). The Effect Of Tangibles, Responsiveness, And Reliability On Customer Satisfaction Of Delivery Services. SSRG International Journal of Economics and Management Studies (SSRG-IJEMS), 6.  
<https://www.internationaljournalsssrg.org/IJEMS/2019/Volume6-Issue5/IJEMSV6I5P113.pdf>
- Hazbar, A. M. H., Alem Mohammed, A., & Karim, A. K. A. (2019). An Empirical Study of Factors Influencing hotel customers' online booking Intention. *مجلة العلوم التربوية و الدراسات الإنسانية*, (5), 1-17.
- KENPRO. (2012, August 25). Sample Size Determination Using Krejcie and Morgan Table | Kenya Projects Organization [KENPRO]. Kenpro.org. <http://www.kenpro.org/sample-size-determination-using-krejcie-and-morgantable/>
- Li, L., Ragavan, N. A., Patwary, A. K., & Bajjun, W. (2022). Measuring patients' satisfaction toward health tourism in Malaysia through hospital environment, nutritional advice, and perceived value: A study on Chinese exchange students. *Frontiers in public health*, 10, 893439.
- Li, L., Wu, B., & Patwary, A. K. (2022). How marine tourism promote financial development in sustainable economy: new evidences from South Asia and implications to future tourism students. *Environmental Science and Pollution Research*, 29, 1155-1172.
- Li, L., Wu, B., & Patwary, A. K. (2022). The psychosocial factors affecting chinese Outbound Exchange and mobility students' academic performance during COVID-19. *Frontiers in psychology*, 13, 872516.
- Pakurár, M., Haddad, H., Nagy, J., Popp, J., & Oláh, J. (2019). The Service Quality Dimensions that Affect Customer Satisfaction in the Jordanian Banking Sector. *Sustainability*, 11(4), 1113. <https://doi.org/10.3390/su11041113>
- Patwary, A. K., Roy, B., Hoque, R., & Khandakar, M. S. A. (2019). Process of developing a community based tourism and identifying its economic and social impacts: An Empirical study on Cox's Bazar, Bangladesh. *Pakistan Journal of Humanities and Social Sciences*, 7(1), 1-13.
- Rajput, A., & Gahfoor, R. Z. (2020). Satisfaction and revisit intentions at fast food restaurants. *Future Business Journal*, 6(1). <https://doi.org/10.1186/s43093-02000021-0>
- Razak, I., Nirwanto, N., & Triatmanto, B. (2016). *Journal of Marketing and Consumer Research* www.iiste.org ISSN. An International Peer-Reviewed Journal, 30. <https://core.ac.uk/download/pdf/234694248.pdf>
- Results/Findings Sections for Empirical Research Papers. (n.d.). [https://www.jmu.edu/uwc/files/link-library/empirical/findings-results\\_section\\_overview.pdf](https://www.jmu.edu/uwc/files/link-library/empirical/findings-results_section_overview.pdf)
- Service Quality Definition & How to Achieve Customer Satisfaction with SERVQUAL. (2021, April 29). Feriors. <https://feriors.com/service-quality-servqual-definition-customer-satisfaction/>
- Suciptawati, N. L. P., Paramita, N. L. P. S. P., & Aristayasa, I. P. (2019). Customer satisfaction analysis based on service quality: case of local credit provider in Bali. *Journal of Physics: Conference Series*, 1321, 022055. <https://doi.org/10.1088/1742-6596/1321/2/022055>
- Sumethokula, P., Patwary, A. K., Srinuanpanc, B., Srinuanpand, C., Suwandee, P., Thammathikul, A., & Phanong, W. (2020). The potential of new tour repackaging for

- creative tourism among entrepreneurs in Nakhon Si Thammarat. *International Journal of Innovation, Creativity and Change*, 13(10), 1752-1771.
- Understanding the Pearson Correlation Coefficient | Outlier. (2023, April 11). *Articles.outlier.org*.  
<https://articles.outlier.org/pearson-correlation-coefficient>
- University of Southern California. (2014). *Research Guides: Organizing Your Social Sciences Research Paper: Limitations of the Study*. Usc.edu.  
<https://libguides.usc.edu/writingguide/limitations>
- Using Quality Assurance to Improve Your Customer Service | CustomerThink. (n.d.).  
*Customerthink.com*.<https://customerthink.com/using-quality-assurance-toimproveyour-customer-service/>
- Wu, B., Liu, S., Wang, J., Tahir, S., & Patwary, A. K. (2021). Assessing the mechanism of energy efficiency and energy poverty alleviation based on environmental regulation policy measures. *Environmental Science and Pollution Research*, 28, 40858-40870.
- Wu, B., Zhai, B., Mu, H., Peng, X., Wang, C., & Patwary, A. K. (2021). Evaluating an economic application of renewable generated hydrogen: A way forward for green economic performance and policy measures. *Environmental Science and Pollution Research*, 1-15.

# STUDENT'S BEHAVIOR TOWARDS FAST FOOD RESTAURANT AT UNIVERSITI MALAYSIA KELANTAN (CITY CAMPUS)

*Nur Hidayah Nabilah Binti Zamri, Nur Husna Binti Zahari, Nur Sabrina Binti Bhogawi, Nur Sakinah Binti Khalid.*

*Faculty of Hospitality, Tourism and Wellness, Universiti Malaysia Kelantan*

*Corresponding email: hafizahm@umk.edu.my*

---

## ABSTRACT

According to the trends and changes of modern life, the needing of fast food is one of our daily habits. Although it can be seen by young people, teenagers, the elderly and especially students, fast food is an easy option for them to find food. This study aims to examine the undergraduate student's behavior towards fast food restaurant in Universiti Malaysia Kelantan (City Campus). This study used quantitative research design approaches. Questionnaires administered to collect the required information where about 385 respondents of Universiti Malaysia Kelantan participated in this study. This study beneficial to the advent of changing lifestyles, the demand fast food products as it is enhancing day by day especially among the student fraternity and the trend is immensely increasing. The findings of this study shows that attitude have significant supports ( $R = <0.762$ ). Meanwhile the result for the second hypothesis which is a subjective norm supports ( $R = <0.672$ ). The last hypothesis is a perceived behavioral control that supports ( $R = <0.724$ ). These indicated that Universiti Malaysia Kelantan students are prone to fast food of compared to other types of food.

**Keywords: Fast Food, Attitude, Subjective Norm, Perceived Behavioral Control**

---

## INTRODUCTION

Indeed, fast - food is remarkably close to them, and it has become a habit when they have no choice but to eat fast food (Syafiqah et al., 2018). Even though the students are aware that eating fast food in excess might be dangerous, fast food marketing strategies that have been quickly picked up by the media have been effective in distracting them with eye-catching advertisements and tempting deals (Brindal et al., 2011). This is also evident when the fast food has its own draw, such as visually appealing, intriguing food like MCD, which is credited with giving it variety.

Fast food has also defined mainly food from fast food chains from all over the country for examples McDonald's, Domino's Pizza, Subway, Pizza Hut, Kentucky Fried Chicken and Texas Chicken and all these fast foods can be eaten there or taken away (Janssen et al., 2018). However, takeout certainly includes many definitions and comes from many sources, including vending machines, convenience stores, fast food stores, takeaways, coffee shops, schools., etc. The concept of fast food is often used to describe food that is prepared quickly and at a reasonable price. It is also commonly referred to as an alternative to home cooked meals. In restaurants, fast food is often offered in a package that makes it easy to take home (Hamrick & Okrent, 2016). Today's fast food is a choice, especially for college students. In fact, fast food is the kind of food that you can easily buy and carry anywhere because you do not have to think about anything other than cooking it at home. Eating out such as fast food, tends to be less healthy because it has more energy and fewer nutrients than cooking at home. This is evidenced by the fact that it often contains ingredients such as fat, salt, and sugar and from these ingredients are associated with weight gain and various adverse health effects that can affect an individual's health.

Hence, the focus of this study is to find out the student's behavior towards fast food restaurant at Universiti Malaysia Kelantan (City Campus). There are three objectives of this study:

2. To identify the relationship between the attitude and student's behavior towards fast food restaurant.
3. To determine the relationship between the subjective norms and student's behavior towards fast food restaurant.
4. To identify the relationship between the perceived behavioral control and student's behavior towards fast food restaurant.

## **SIGNIFICANCE OF THE STUDY**

This research's objective is to inquire into the ways in which variables affecting student attitudes toward fast food businesses would affect respondents' perceptions. This is particularly corroborated by Benajiba (2016), who claimed that it was obvious that adults consume a lot of fast food, particularly college students. There is evidence that the same eating behavior exists in other nations.

## **LITERATURE REVIEW**

### **Attitude**

According to researchers (Ajzen, I., 1975), the nature of the relationship between beliefs and attitudes is specified by the theory of planned behaviour. Ajzen explains that an individual's evaluation or attitude toward a behaviour is determined by his or her accessible beliefs about the behaviour. In this theory, belief refers to the subjective that a given behaviour will result in a specific outcome. In particular, the evaluation of each outcome contributes to the attitude in proportion to the person's subjective probability that the behaviour produces the desired outcome.

The expectancy-value model gave rise to the concept of outcome expectancy. A belief, attitude, opinion, or expectation can all be categorised as outcome expectancy. (Fishbein, M., 1975) According to the theory of planned behaviour, a positive evaluation of one's own performance of a specific behaviour is analogous to the concept of perceived benefits. A positive evaluation is a belief in the effectiveness of the proposed behaviour in lowering the risk of negative outcomes. A negative self-evaluation, on the other hand, refers to a belief about the negative consequences of engaging in the behaviour. (Ajzen, I.,1975).

### **Subjective Norms**

Subjective norms on customer intention are defined as the influence of outside factors and refers to significant individuals or groups that indicate the chance that carrying out a behavior will be accepted or rejected (Ajzen, 1991). According to Taylor (1999), when an individual's activities have an impact on another person's benefit, a subjective standard is an effective translator of behavior. On the other hand, when only one person is involved in the selection



process, the issue of subjective norms is irrelevant, according to Lapinski, Rimal, DeVries, and Lee (2007).

In addition, with the help of subjective norm and complying motivation, subjective norm is established. Normative belief was investigated by asking students three questions regarding how they perceived their parents', teachers', and friends' attitudes on eating fast food. By posing the students with three questions about how they perceived about their parents', teachers', and friends' perspectives on eating fast food, normative belief was examined. By asking the students how much they respected and concurred with the views of persons who were significant to them, the motivation to comply was examined. Since the beliefs of children's friends regularly differed from those of their parents and teachers, the internal reliability for the subjective norm was not as high as it could have been.

Additionally, in previous research on the planning and behavior of food purchases, the subjective norm influencing by behavior was not obvious. This is because, using customer motivation, subjective norms carry out a behavior to construct the initial moments of crucial individuals like family, friend, and significant others. Customers are driven to behave in a way that complies with the subjective standard to recreate the first moments of an important individual.

### **Perceived Behavioral Control**

First and foremost, it was observed that perceived behavioral control over fast food consumption was significantly adversely linked with consumption intention and frequency. The inclusion of self-efficacy, characterized as confidence in one's ability to frequently consume functional foods, turned out to be the most important determining factor for intention (Nystrand and Olsen, 2020).

The accessibility of appropriate resources and the ability to handle behavioral challenges have an impact on behavioral performance. An individual seems to have more control over their actions and a stronger intention to carry them out the more resources they perceive and the fewer impediments they face. People who may have the intention to change and maintain certain health behaviors, but whose everyday environment may not encourage those behaviors by eating fast food frequently (Shantanam & MUELLER, 2018). Fast food's accessibility and price in community settings, as well as its convenience, have been identified as obstacles to regular, daily healthy eating.

Perceived behavioral control includes the ability to try new foods without worrying about leftovers, the ability to gradually introduce healthy foods into the family diet, and the ability to learn to use cooking utensils (Nystrand and Olsen, 2020). Food waste and food costs are major issues that adversely affect control of an individual's perception of healthy home cooking. Thus, for this reason will find it easier and more convenient to buy fast food, even if it costs money.

## Research Hypothesis

The literature analysis showed that student's behavior towards fast food restaurant at Universiti Malaysia Kelantan (City Campus) include attitude, subjective norms, and perceived behavioral control. As a result, the study intended to look at the relative importance of these variables. This study's hypothesis outlined as follows:

4. There is significance relationship between the attitude and behavior towards fast food restaurant.
5. There is a significance relationship between the subjective norms and behavior towards fast food restaurant.
6. There is a significance relationship between the perceived behavioral control and behavior towards fast food restaurant.

## Research Framework

The Figure 1 below shows the research framework use for this study.

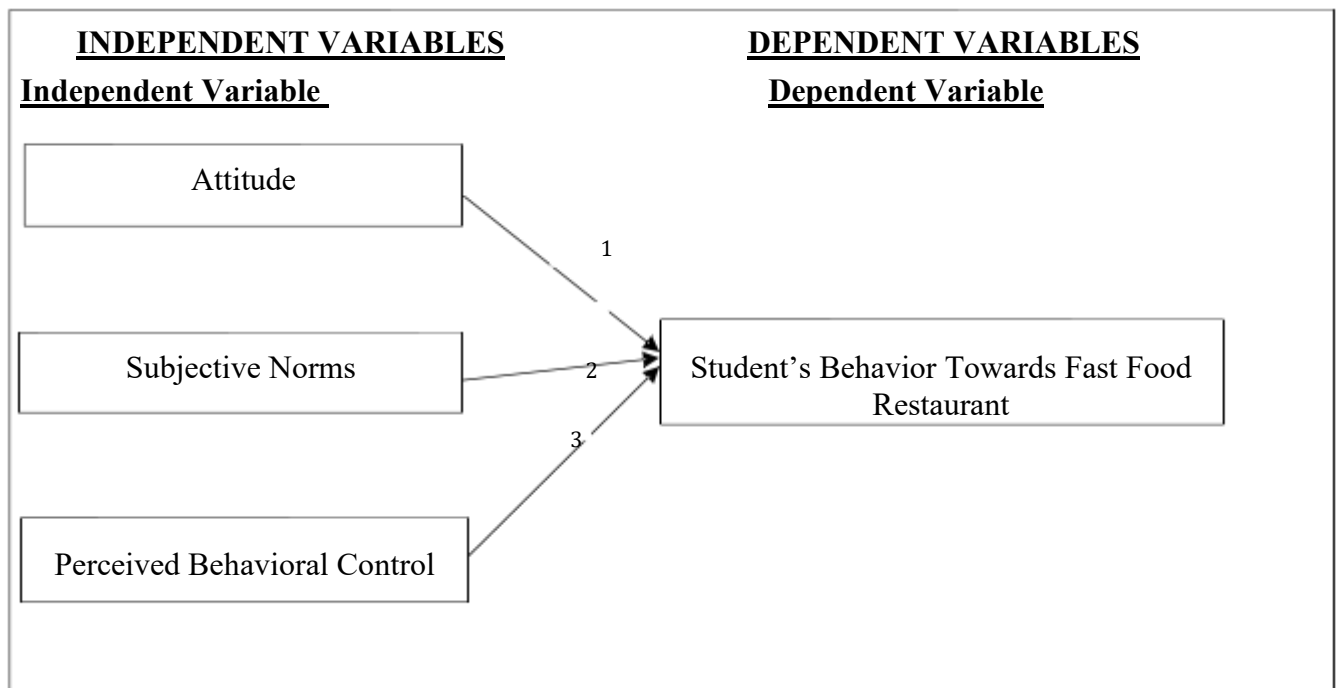

## **METHODOLOGY**

### **Research Design**

The focus of Inaam Akhtar's covert investigation is problem distribution control, and data are measured and analysed using quantitative methods. Based on Oberiri Destiny Apuke's (2017) description of this method is appropriate for analysing issues and identifying phenomena. To precisely measure and analyse target concepts, clear up ambiguities, and spot business opportunities, quantitative research especially statistics is used. The difficulties that businesses face in the digital age can be particularly effectively addressed with this strategy.

This descriptive research at Universiti Malaysia Kelantan focuses on the relationship between attitude, subjective norms, and perceived behavioural control towards fast food in restaurants. Data will be collected through self-directed questionnaires and quantitative methods, aiming to understand students' attitudes and behaviours in this context.

### **Data Collection**

Data collection is the process of gathering, measuring, and analysing precise insights for research purposes using standardised validated techniques, according to (Bhat, A, 2022). The data gathered can be used by the researcher to assess their hypothesis. The gathering of data is typically the first and most important step, regardless of the field of study. Depending on the information required, different fields of study employ different approaches to data collection.

The study used a quantitative method of data collection, gathering secondary data through surveys and questionnaires. Comparing this approach to qualitative data, it is thought to be more impartial and trustworthy. The questionnaires, which are broken up into five sections, are easier for respondents to complete because they are available in both English and Malay. The data collected using this method will be analysed and compared by the researchers to ensure a thorough understanding of the research topic.

### **Sampling**

Fleetwood (2018) emphasises the value of the sampling method, which involves gathering people at their convenience, in market action research. There are two types of sampling: non-probability sampling, which randomly selects participants without a predetermined selection procedure, and probability sampling, which chooses participants from a population at random using a set of criteria. The distribution of study participants can be understood using either type of sampling technique.

According to Pelz (2022), sampling is a statistical procedure that entails choosing a subset of a population in order to draw observations and conclusions. A given population's behavioural trends are to be inferred using this process. It is impossible to study the entire population, though, due to practical and financial constraints. In order to observe and analyse the target group, a representative sample of that group must be chosen. To achieve a reliable and valid sample for this study, researchers used the equation from Krejcie & Morgan (1970) to determine the sample size. Based on the table of Krejcie & Morgan (1970) the appropriate sample size for this research is 384 respondents. The study population comprises students at UMK City Campus, University of Kelantan, Malaysia, including FPV, FHPK, and FKP. The campus has 6,237 students, with FKP having 3,495, FHPK 2,518, and FPV having 224.

## **Data Analysis**

Zikmund (2003) analyzed statistical data using SPSS software version 20.0, focusing on detailed surveys. The study employed descriptive statistics and reliability tests, utilizing various steps to condense and restructure the data into relevant details.

Aaker, Kumar, and Day (2007) conducted descriptive analysis, identifying key characteristics of respondents' data. Frequency distribution, measures of central tendency, dispersion, and shape were discussed, as well as data transformations like skewness. Frequencies were derived from nominal factors like gender, education level, and fast food restaurant visits. Zikmund (2003) used nominal or ordinal scales for measurement. Malhotra et al. (2006) generated tables of frequency counts, percentages, and cumulative percentages for all values associated with the variable.

## FINDINGS

### Results of Frequency Analysis.

Table 1 shows the data for gender of respondents. From the total of 385 respondents, 142 respondents were male with the total percentage of 36.9 percent. For female respondents, there were 243 with the total percentage of 63.1 percent. From the 385 respondents have been collected, respondents who consists of 18 - 20 years old were 22 (5.7%) respondents followed by 21 - 23 years old were 279 respondents (72.5%), 24 - 26 years old were 73 respondents (19%), 27 - 29 years old were 11 respondents (2.9%) and other were no one. From the data, the highest age group who have been contributing to the research are from 21 - 23 years old were 279 respondents (72.5%) and the lowest age group are others.

Out of 363 respondents who are married status were 22 respondents with 5.7 % value. From 385 respondents have been collected, respondents who consist of Malay were 269 respondents followed by Indian and Chinese who have same total of respondents which is 51 (13.2%) respondents and other were 14 (3.6%) respondents. From the data, the highest race who have contributed to the research are Malay 269 (69.9%) respondents and the lowest race are other 14 respondents (3.6%) in Universiti Malaysia Kelantan (City Campus).

From the table ,272 respondents were Islam with a total percentage of 70.6 %. Next is Hindu were 51 respondents with a total percentage 13.2%, buddha were 30 respondents with a total a percentage of 7.8% and lastly where others were 32 respondents with a total percentage 8.3%, Through the data, the higher number of participants to answer the survey were from Islam 70.6 % and the lowest number of participants were from buddha 7.8%.

From the data it shows the various faculty that we have. Among these four faculties, the highest number of respondents were from the Faculty of Hospitality, Tourism and Wellness (180 respondents) with the number of percentages 46.8%. The second highest number of respondents were from the Faculty of Entrepreneurship and Business (113 respondents) with the number of percentages 29.4%. Followed by the Faculty of Data and Computer Science (48 respondents) with the number of percentages 12.5% and the lowest number of respondents were from the Faculty of Veterinary Medicine (44 respondents) with the number of percentages 11.4%.

From the data above, 234 respondents (60.8%) out of 385 respondents were from Year 3. This is because most respondents of this study were from Year 3, and they have many contacts and time to answer this survey. Hence, the respondents of years of study from Year 1 are not less high than others which is 55 respondents (14.3%), followed by Year 2 showing the number of respondents were 51 respondents (13.2%) and Year 4 showing the number of respondents were 41 respondents (10.6%). The lowest number of respondents for years of study from Year 5 were 4 respondents (1%).

The number of percentages 32.5% were from the East Region (Kelantan, Terengganu, and Pahang). The second highest respondents were from the West Region (Melaka, Perak, Selangor, and Wilayah Persekutuan) 115 respondents with the number of percentages 29.9% followed by the North Region (Perak, Kedah and Pulau Pinang) 64 respondents with the number of percentages 16.6%. Next, the state of origin from the South Region (Negeri Sembilan and Johor) were 56 respondents with the number of percentages 14.5% and the number of respondents from Borneo were 24 respondents at 6.2% while the lowest number of respondents were from overseas 1 respondent 0.3%.

Table 1 : Frequency Analysis

No	Socio -Demographic Characteristic	Frequency (n)	Percentage (%)
1.	Gender	385	100

	Male	142	36.9
	Female	243	63.1
2.	<b>Age Group</b>	<b>385</b>	<b>100</b>
	18-20 years old	22	5.7
	21-23 years old	279	72.5
	24-26 years old	73	19
	27-29 years old	11	2.9
3.	<b>Marital Status</b>	<b>385</b>	<b>100</b>
	Single	363	94.3
	Married	22	5.7
4.	<b>Race</b>	<b>385</b>	<b>100</b>
	Malay	269	69.9
	Indian	51	51
	Chinese	51	51
	Others	14	3.6
5.	<b>Religion</b>	<b>385</b>	<b>100</b>
	Islam	272	70.6
	Hindu	51	13.2
	Buddha	30	7.8
	Others	32	8.3
6.	<b>Faculty</b>	<b>385</b>	<b>100</b>
	Faculty of Hospitality, Tourism and Wellness.	180	46.8
	Faculty of Entrepreneurship and Business.	113	29.4
	Faculty of Veterinary Medicine	44	11.4
	Faculty of Data and Science Computer	48	12.5
7.	<b>Years of study</b>	<b>385</b>	<b>100</b>
	Year 1	55	14.2
	Year 2	51	13.2
	Year 3	234	60.8
	Year 4	41	10.6
	Year 5	4	1
8.	<b>State of origin</b>	<b>385</b>	<b>100</b>
	East Region (Kelantan, Terengganu & Pahang)	125	32.5
	West Region (Melaka, Perak, Selangor & Wilayah Persekutuan)	115	29.9 & 56
	South Region (Negeri Sembilan & Johor)	14.5	
	North Region (Perlis, Kedah & Pulau Pinang)	64	16.6
	Borneo (Sabah & Sarawak)	24	6.2
	Overseas	1	0.3

## Results of Descriptive Analysis.

Table 2 : Descriptive Analysis.

No	Variables	Mean Score	Standard Deviation
1.	<b>Attitude</b>		
	I think fast food is very tasty.	4.23	0.858
	I think fast food is safe to eat.	3.62	0.958
	I think fast food has a lot of calories.	4.29	0.932
	I think fast food restaurant have a fast service.	4.19	0.850
	I think fast food restaurant are easily accessible near me.	4.29	0.819
	I think that fast food restaurant provided fun environment.	4.16	0.885
2.	<b>Subjective Norms</b>		
	If I were an easy-going person, I will be more easily convinced to eat fast food.	3.72	1.199
	I would visit fast food restaurants if I helped me fit in with my social group.	3.75	1.011
	I will follow those close to me to eat fast food regularly.	3.73	1.109
	I am interested in the menu promotions that are often posted on social media.	4.15	0.926
3.	<b>Perceived Behavioral Control</b>		
	I can take the decision independently to buy fast food.	4.26	0.854
	I have the financial capability to buy fast food.	3.99	0.829
	I have time to shopping to buy fast food.	4.04	0.884
	I have complete information and awareness regarding where to buy fast food.	4.14	0.864
	Fast food is readily available in the location where I reside.	4.28	0.779
4.	<b>Behavior Toward Fast Food Restaurant</b>		
	I think fast food saves a lot of time in meal preparation.	4.31	0.787
	I prefer going to fast food restaurant due to their proximity.	3.86	0.918
	I prefer choose fast food restaurant because it is open until late at night.	4.06	0.932
	I think fast food is preferred because of its very quick preparation.	4.17	0.898
	Fast food restaurants are very practical.	4.04	0.801

**Results of Reliability Test.**

Table 3: Reliability Test.

<b>Variable association</b>	<b>Number of item</b>	<b>Cronbach alpha</b>	<b>Strength of Coefficient</b>
Attitude	6	0.862	Very good
Subjective norm	4	0.810	Very good
Perceived behavioral control	5	0.887	Very good
Behavior toward Fast food Restaurants	5	0.884	Very good

**Results of Pearson Correlation Analysis.**

Table 4 shows the result of the correlation among independent variables and dependent variables by using Pearson’s correlation coefficient. the attitude and behavior toward fast food restaurants has a high association correlation,  $r = 0.762$ .

Table 4: Result of Pearson Correlation Analysis.

Attitude	Subjective Norm	Perceived Behavioral Control	Student Behavior Toward Fast
----------	-----------------	------------------------------	------------------------------



---

				Restaurant
Attitude	1	0.651	0.754	0.762
		1	0.679	0.672
Subjective norm	0.651			
Perceived		0.679	1	0.724
Behavioral	0.754			
Control				
Student Behavior		0.672	0.724	1
Toward fast food	0.762			
Restaurant				

### Results of Hypothesis Testing.

Table 5 shows the hypothesis testing based on regression analysis. Between all hypothesis above, the attitude of the component states the highest at  $r = 0.762$ ,  $p = < 0.01$ . Then, it is followed by perceived behavioral control at  $r = 0.724$ ,  $p = < 0.01$  and the subjective norm is the moderate in strength of association which is  $r = 0.672$ ,  $p = < 0.01$  that is related to student behavior toward fast food restaurants. As a result, at a 0.01 significance level, all hypothesis states were accepted.

Table 5: Hypothesis Testing.

---

Hypothesis	Pearson correlation result
------------	----------------------------

---

---

H1	There is significance relationship between the attitude and behavior towards fast food restaurant.	$r = 0.762, p = < 0.01$	Supported
H2	There is a significance relationship between the subjective norms and behavior towards fast food restaurant.	$r = 0.672, p = < 0.01$	Supported
H3	There is a significance relationship between the perceived behavioral control and behavior towards fast food restaurants.	$r = 0.724, p = < 0.01$	Supported

---

## DISCUSSION AND RECOMMENDATION

In this section, the researcher will present some recommendations aimed at improving future research. These suggestions are intended to enhance the quality of research outcomes and assist students in the recruitment process for fast food restaurants.

In the current study, the researcher focused on three variables: attitude, subjective norms, and perceived behavioral control (independent variable), and behavior towards fast food restaurants (dependent variable). The findings revealed a moderate positive correlation between the independent and dependent variables. To advance the field, future researchers could explore the inclusion of different independent variables to generate new findings. Additionally, the study did not extensively address the design of fast food restaurant websites, which are available through various platforms such as GrabFood and Food Panda. Future research could investigate if respondents prefer booking directly from the official website, potentially yielding new insights.

For future studies, it is recommended that researchers continue using quantitative methods for data collection instead of qualitative approaches. However, the researcher suggests distributing face-to-face questionnaires to respondents. This is because the current study employed social media for questionnaire distribution, leading to biases in the results. Conducting face-to-face surveys would allow researchers to gather additional information from selected respondents and address any confusion or the use of jargon.

Lastly, the study's respondents were chosen based on their selection of a fast food restaurant. It is suggested that future studies consider including guests who have visited the restaurant and made reservations to purchase fast food. This would ensure that respondents have firsthand experience and can provide more detailed assessments. By selecting an appropriate sample of respondents, the study's results would be more accurate.

## CONCLUSION

To conclusion this chapter, all the variables examined in relation to fast food restaurants showed a significant relationship. This indicates that these variables play a role in influencing students' consumption of fast food. Through descriptive analysis, reliability testing, and correlation analysis, the variables demonstrated values above 0.7, which is considered acceptable for this study. Despite the limitation of conducting the study online, it did not hinder the acquisition of data. Lastly, the suggestions provided in this chapter will be beneficial for future studies in this field.

## REFERENCES

- Adam, A. (2016). *Knowledge , attitudes, and practices towards consumption of fast food among FSH students of Maldives National University. June.*
- Ajzen, I. (2001). Nature and Operation of Attitudes. *Annual Review of Psychology*, 52(1), 27– 58. <https://doi.org/10.1146/annurev.psych.52.1.27>

- Akter, M., Sadekin, M. N., & Patwary, A. K. (2020). An Empirical Study on Students' Satisfaction from Mawlana Bhashani Science & Technology University, Bangladesh. *Review of Economics and Development Studies*, 6(2), 363-379.
- Allport, G.W. (1935) Attitudes. In Murchison, C., Ed., *Handbook of Social Psychology*, Clark University Press, Worcester, MA, 798-844. - References - Scientific Research Publishing. (n.d.-b). <https://scirp.org/reference/referencespapers.aspx?referenceid=1955874>
- Alom, S., Patwary, A. K., & Khan, M. M. H. (2019). Factors affecting the turnover intention of Bangladeshi migrants in the United Arab Emirates: An empirical study on the hotel industry. *International Journal of Innovation, Creativity and Change*, 8(3), 344-360.
- Anshari, Z. (2019, October 12). Gambaran Pengetahuan , Sikap, dan Tindakan Pelajar Tentang Makanan Cepat Saji (Fast Food) di Mts Al-Manar Medan | Anshari | BEST Journal (Biology Education, Sains and Technology). <https://jurnal.uisu.ac.id/index.php/best/article/view/1776>
- APA Dictionary of Psychology. (n.d.2022) <https://dictionary.apa.org/>
- Bakare, K. O., & Olumakaiye, M. F. (2016). Fast food consumption pattern and body weight status among students of Obafemi Awolowo University, Ile-Ife, Nigeria. *African Journal of Food, Agriculture, Nutrition and Development*, 16(4), 11185–11198. <https://doi.org/10.18697/ajfand.76.15020>
- Bhat, A. (2022, December 26). *Data Collection: What it Is & Methods with Examples*. QuestionPro. <https://www.questionpro.com/blog/data-collection/>
- Bowman, S. A., Gortmaker, S. L., Ebbeling, C. B., Pereira, M. A., & Ludwig, D. S. (2004). Effects of Fast-Food Consumption on Energy Intake and Diet Quality among Children in a National Household Survey. *Pediatrics*, 113(1 I), 112–118. <https://doi.org/10.1542/peds.113.1.112>
- Brindal, E., Wilson, C., Mohr, P., & Wittert, G. (2011). Does meal duration predict amount consumed in lone diners? An evaluation of the time-extension hypothesis. *Appetite*, 57(1), 77–79. <https://doi.org/10.1016/j.appet.2011.03.013>
- Cronbach's Alpha: Definition, interpretation, SPSS. (2022, February 28). Statistics How To. <https://www.statisticshowto.com/probability-and-statistics/statistics-definitions/cronbachs-alpha-spss/#whatis>
- Dunn, K. I., Mohr, P. B., Wilson, C. J., & Wittert, G. A. (2008). Beliefs about fast food in Australia: A qualitative analysis. *Appetite*, 51(2), 331–334. <https://doi.org/10.1016/j.appet.2008.03.003>
- Farhana Quoquab Habib, Rozhan Abu Dardak, & Sabarudin Zakaria. (2011). Consumers' preference and consumption towards fat food: Evidences from Malaysia. *Business Management Quarterly Review*, 2(1), 14–27
- Fengmin, Z., Baijun, W., Jiangtao, B., Li, L., & Patwary, A. K. (2022). Investigating revisit intention of medical tourists in China through nutritional knowledge, perceived medical quality, and trust in the physiologist: A recommendation on health tourism policy measures. *Frontiers in Public Health*, 10, 893497.
- Hamrick, K. S., & Okrent, A. (2016). The Role of Time in Fast-Food Purchasing Behavior in the United States. *SSRN Electronic Journal*, May 2019. <https://doi.org/10.2139/ssrn.2677707>
- Hardin-Fanning, F., & Ricks, J. M. (2016). Attitudes, social norms and perceived behavioral control factors influencing participation in a cooking skills program in rural Central Appalachia. *Global Health Promotion*, 24(4), 43–52. <https://doi.org/10.1177/1757975916636792>

- Hazbar, A. M. H., Alem Mohammed, A., & Karim, A. K. A. (2019). An Empirical Study of Factors Influencing hotel customers' online booking Intention. *مجلة العلوم التربوية و الدراسات الإنسانية*, (5), 1-17.
- Head, C. S. (2016). *College of Health and Life Sciences*. 2(February), 2016.
- Islamia, J. M. (2016). Research design Research design. *Research in Social Science: Interdisciplinary Perspectives*, September, 68–84. file:///E:/Documents/dosen/buku Metodologi/[John\_W.\_Creswell]\_Research\_Design\_Qualitative,\_Q(Bookos.org).pdf
- James, E. (n.d.). *What is correlation analysis? A definition and explanation*. Blog | FlexMR. <https://blog.flexmr.net/correlation-analysis-definition-exploration>
- Janssen, H. G., Davies, I. G., Richardson, L. D., & Stevenson, L. (2018). Determinants of takeaway and fast food consumption: A narrative review. *Nutrition Research Reviews*, 31(1), 16–34. <https://doi.org/10.1017/S0954422417000178>
- Just a moment...* (n.d.). ResearchGate | Find and share research. <https://www.researchgate.net>
- Li, L., Ragavan, N. A., Patwary, A. K., & Baijun, W. (2022). Measuring patients' satisfaction toward health tourism in Malaysia through hospital environment, nutritional advice, and perceived value: A study on Chinese exchange students. *Frontiers in public health*, 10, 893439.
- Li, L., Wu, B., & Patwary, A. K. (2022). How marine tourism promote financial development in sustainable economy: new evidences from South Asia and implications to future tourism students. *Environmental Science and Pollution Research*, 29, 1155-1172.
- Li, L., Wu, B., & Patwary, A. K. (2022). The psychosocial factors affecting chinese Outbound Exchange and mobility students' academic performance during COVID-19. *Frontiers in psychology*, 13, 872516.
- Majid, U. (2018). Research Fundamentals: Study Design, Population, and Sample Size. *Undergraduate Research in Natural and Clinical Science and Technology (URNCSST) Journal*, 2(1), 1–7. <https://doi.org/10.26685/urncst.16>
- Marketplace Lifestyles in an Age of Social Media: Theory and Methods. (2012, August 28). Routledge & CRC Press. <https://www.routledge.com/Marketplace-Lifestyles-in-an-Age-of-Social-Media-Theory-and-Methods/Kahle-Valette-Florence/p/book/9780765625618>
- Mirkarimi, K., Mansourian, M., Kabir, M. J., Ozouni-Davaji, R. B., Eri, M., Hosseini, S. G., Qorbani, M., Safari, O., Mehr, B. R., Noroozi, M., Charkazi, A., & Shahnazi, H. (2016). Fast food consumption behaviors in high-school students based on the Theory of Planned Behavior (TPB). *International Journal of Pediatrics*, 4(7), 2131–2142. <https://doi.org/10.22038/ijp.2016.7011>
- Mohr, P., Wilson, C., Dunn, K., Brindal, E., & Wittert, G. (2007). Personal and lifestyle characteristics predictive of the consumption of fast foods in Australia. *Public Health Nutrition*, 10(12), 1456–1463. <https://doi.org/10.1017/S1368980007000109>
- Moran, M. (2021, August 3). *Cronbach's Alpha*. Statistics Solutions. <https://www.statisticssolutions.com/cronbachs-alpha/>
- Othman, C., & Rahman, M. S. (2014). Investigation of the relationship of brand personality, subjective norm and perceived control on consumers' purchase intention of organic fast food. *Modern Applied Science*, 8(3), 92.

- Patwary, A. K., Roy, B., Hoque, R., & Khandakar, M. S. A. (2019). Process of developing a community based tourism and identifying its economic and social impacts: An Empirical study on Cox's Bazar, Bangladesh. *Pakistan Journal of Humanities and Social Sciences*, 7(1), 1-13.
- Pelz, B. (n.d.). *Chapter 8 Sampling | Research Methods for the Social Sciences*. <https://courses.lumenlearning.com/suny-hccc-research-methods/chapter/chapter-8-sampling/>
- Perloff, R. M. (2017). *The Dynamics of Persuasion: Communication and Attitudes in the Twenty-First Century* (Routledge Communication Series) (6th ed.). Routledge.
- Seo, H. sun, Lee, S. K., & Nam, S. (2011). Factors influencing fast food consumption behavior of middle-school students in Seoul: An application of theory of planned behaviors. *Nutrition Research and Practice*, 5(2), 169–178. <https://doi.org/10.4162/nrp.2011.5.2.169>
- Souiden, N., Chaouali, W., & Baccouche, M. (2019). Consumers' attitude and adoption of location-based coupons: The case of the retail fast food sector. *Journal of Retailing and Consumer Services*, 47, 116-132.
- Sumethokula, P., Patwary, A. K., Srinuanpanc, B., Srinuanpand, C., Suwandee, P., Thammathikul, A., & Phanong, W. (2020). The potential of new tour repackaging for creative tourism among entrepreneurs in Nakhon Si Thammarat. *International Journal of Innovation, Creativity and Change*, 13(10), 1752-1771.
- Syafiqah, I., Riza, N., Chik, A., Zm, L., Syafiqah, I. N., Normala, R., Azlini, C., Lukman, Z. M., & Kamal, M. Y. (2018). Fast Food Consumption Behavior among University Students. *International Journal of Research and Innovation in Social Science (IJRISS) | Volume, II*(November 2019), 2454–6186. <https://doi.org/10.13140/RG.2.2.21347.30240>
- Tabassum, A., & Rahman, T. (2012). Differences in Consumer Attitude towards Selective Fast Food Restaurants in Bangladesh: An Implication of Multiattribute Attitude Model. *Differences in Consumer Attitude Towards Selective Fast Food Restaurants in Bangladesh: An Implication of Multiattribute Attitude Model*.
- The Theory of Planned Behavior. (2022) <https://sphweb.bumc.bu.edu/otlt/mph-modules/sb/behavioralchangetheories/BehavioralChangeTheories3.html>
- What is Attitude? Definition, Types, Components, Formation, Functions, Characteristics. (2021, April 17). Geektonight. <https://www.geektonight.com/what-is-attitude-meaning-functions-types-importance-components/>
- Wu, B., Liu, S., Wang, J., Tahir, S., & Patwary, A. K. (2021). Assessing the mechanism of energy efficiency and energy poverty alleviation based on environmental regulation policy measures. *Environmental Science and Pollution Research*, 28, 40858-40870.
- Wu, B., Zhai, B., Mu, H., Peng, X., Wang, C., & Patwary, A. K. (2021). Evaluating an economic application of renewable generated hydrogen: A way forward for green economic performance and policy measures. *Environmental Science and Pollution Research*, 1-15.

# **The Acceptance of Street Food Among University Students in Universiti Malaysia Kelantan, City Campus**

**Nur Syaheera Binti Amran, Nur Syahira Izzati Binti Shahidan, Nur Syamimi Binti Mohd Hanafi, Nur Syamsina Binti Md Sabri & Puan Harnidah Binti Samengon**

*Faculty of Hospitality, Tourism and Wellness, Universiti Malaysia Kelantan*

*Corresponding email:harnidah@umk.edu.my*

---

## **ABSTRACT**

This study aims to examine the acceptance of street food among university students at Universiti Malaysia Kelantan. Thus, the researcher wants to know the relationship between food price, attraction, and service quality with the acceptance of street food among university students in UMK City Campus. This study uses quantitative approaches. The questionnaire was administered to capture the necessary data. The evaluation has been completed on 370 total responses. The finding of this research showed that the whole hypothesis is accepted. Food price and quality of service got more responses and feedback. The two independent variables are positively associated with the acceptance of street food among university students in UMK City Campus. On the other hand, the attraction exhibited a weak link with the acceptance of street food among university students in UMK City Campus.

**Keywords:** hawker, price, attraction, service quality, food truck

---

## **INTRODUCTION OF THE STUDY**

Research is essential for success in many professions, with action planning, gathering data to support theories, and advancing knowledge. This article explores university students' attitudes toward eating fast food.

Street food consumption habits have changed due to sociocultural changes, so states in Malaysia should brand their cities and market their street food to preserve their reputation and improve their tourism business. Street food acceptance towards university students plays a significant role.

People prefer street foods because of their variety, affordability, and accessibility in many nations. Therefore, eating these meals is widespread around the world. Numerous studies have been conducted on whether eating street food is associated with an increased risk of contracting a disease. This is primarily due to the lack of understanding that street food vendors have regarding sanitation and food safety, as well as the high quantities of infectious germs that have been detected in street food samples. This research has highlighted the significance of the issue.

Today, food-borne illnesses infect millions of people, resulting in thousands of fatalities worldwide (Pilling et al., 2016). One of the elements that contribute to the spread of diseases that are brought on by food sources is the lack of awareness about food safety among those who sell food on the street. Additionally, deficiencies were discovered in numerous studies conducted in some nations regarding the use of hygiene and sanitation, food preparation,

adherence to food safety regulations, and street food vendor knowledge. A lack of sanitation, challenges in obtaining clean drinking water, the inability to remove waste, and other environmental issues, and the fact that street food is not subject to legislation all contribute to increased risks associated with preserving the integrity of food safety standards.

In addition, food tourism is a growing category in the tourist industry, with local cuisine boosting the local tourism industry and customer loyalty. However, street food has become a concern due to the growth in food-borne illnesses in developing nations, with 691 incidents of food poisoning and 49 fatalities in Malaysia.

The four aspects of food quality essential to eating are food safety, nutrition, value, and packaging. Food quality is a critical component in the eating process. Customer expectations, product or service quality, and overall cost all play a role in overall satisfaction, which is determined by customer expectations. Customer satisfaction and acceptance are also key elements. Since it satisfies the requirements of the urban population, street food is an essential component of the food supply chain. Urbanization has increased the number of street food vendors, but the recession and high inflation rates have increased food insecurity.

Street food benefits hawkers and locals economically, but it is still a health risk if not prepared hygienically. The World Health Organization (WHO) proposes using the critical hazard control approach (HACCP) as the most practical and adaptable way to increase street food quality. Penang's street food is well-known among locals and visitors, but the location of the businesses raises concerns about its hygiene and safety. If vendors don't take safety precautions, they endanger the health and safety of the public.

**There are three objectives of this study:**

- i. To determine the relationship between food price and the acceptance of street food among UMK students.
- ii. To identify the relationship between attraction and the acceptance of street food among UMK students.
- iii. To determine the relationship between service quality and street food acceptance among UMK students.

**SIGNIFICANCE OF THE STUDY**

The outcomes of this survey will assist vendors in determining the level of demand for street food among UMK students while also providing additional helpful information to others interested in the topic. Street food offers affordable, quickly accessible food to urban residents, so it is important to research it.

**1. Business operator/restaurant**

Perhaps this study can assist them in determining how university students and the general public interpret street food. Therefore, business/restaurant operators can use this study as a reference in their respective businesses to increase sales and attract customers.



## **2. Economy**

In addition to providing work for themselves, street vendors often generate jobs for others, such as porters, security personnel, transporters, and storage companies. Licensing and permit fees, fines and penalties, and taxes are common ways cities make money.

## **LITERATURE REVIEW**

### **INTRODUCTION**

A literature review is a piece of academic writing that contextualizes and evaluates the academic literature on a given subject, including university students' acceptance of street food.

### **ACCEPTANCE OF STREET FOOD**

#### **DEFINITION ACCEPTANCE OF STREET FOOD**

Street food is a popular tourist attraction in developing nations due to its affordability, convenience, and accessibility. It is typically served in vans or kiosks and is popular with the middle and lower middle classes (R. A. (2014).

Street food is a popular option among university students due to its convenience and cost-friendliness. It is often provided in convenient takeaway packages for less money, and many nations promote it in various ways.

Street food is popular in Malaysia due to its affordability and convenience, making it a popular choice for middle-class consumers. It is prepared in front of the customer, allowing them to change spices and save time (Grover, N., 2012).

#### **FOOD PRICE**

Low-income consumers are more aware of the price and worth than higher-income consumers, and street food sales among university students are cheaper and more convenient due to time savings and convenient location.

Street food sellers need to find strategic sites that are easily accessible and affordable to attract low-income consumers in developing nations. Creativity in interacting with customers can help retain customers.

#### **ATTRACTION**

Street food attracts university students due to its cultural norms, environmental protection, traditional landscapes, and economic activity.

1. Cheap and inexpensive

Price is essential in determining a consumer's intention to purchase, and street food is widely accepted due to its cost-effectiveness.

2. Represents the local cuisine

Street food is a universal language that brings people of different cultures together through the mouth, deepening their connection and spreading the message that there is nothing wrong with being different. Street food is a great way to experience the

uniqueness of the cuisine of the country where you are studying, such as Nasi Kerabu and Budu.

3. Street food has a variety of foods to choose from  
Street food is famous for university students due to its variety, peace of mind, and affordability. It offers authentic food and is prepared quickly, saving time and money.

## **QUALITY OF SERVICE**

Street food owners must use marketing skills to become more competitive and ensure the success of their business. They must also provide the best customer service, as university students buy food on the street faster than at restaurants.

Street food is widely used and can be replicated without sacrificing additional benefits. It has valuable specialties to customers, a tacit understanding of products and creative cooking techniques, uniqueness, diversity, high-quality food, and good service that make it sustainable. It is also related to the relationship factor based on mutual benefit for both parties.

### **Relationship between food price, attraction and service quality and acceptance of street food among university students**

Price is a key factor in determining customer happiness and satisfaction with dining hall services, as well as when choosing where to eat, as it can attract customers. Price has a significant influence on purchasing interest, with university students wanting food and beverages at affordable prices. Respondents compare prices of street foods before purchasing, believing that current prices are reasonable and lower-cost foods may have poorer nutritional value.

The relationship between attraction and the acceptance of street food among university students will benefit society by establishing a local culinary culture, creating employment, and boosting tourism. Street food is prepared food and beverages served by merchants on the street, which is convenient, delicious, and inexpensive. Street food is considered a meal replacement and an attractive component of night markets in Asian countries. Students' satisfaction is measured by evaluating their educational experiences in relation to available services and facilities.

The association between hawkers' focus on treating customers properly, answering their queries, and going above and beyond expectations and acceptability of street food among university students. Alexander (2006) asserts that providing services necessitates direct interaction with customer service representatives and, when done correctly, starts to develop relationships based on trust. Informing friends, family, and co-workers about a business increases consumer satisfaction.

## Research Hypothesis

H1: There is a relationship between price and the acceptance of street food among university students.

H2: There is a relationship between attraction and the acceptance of street food among university students.

H3: There is a relationship between service quality and street food acceptance among university students.

## Research Framework

Figure 1 shows the conceptual framework for this research. The three acceptance that makes up the independent variable that will be proposed are food price, attraction, and quality of service. The dependent variable is the acceptance of street food.

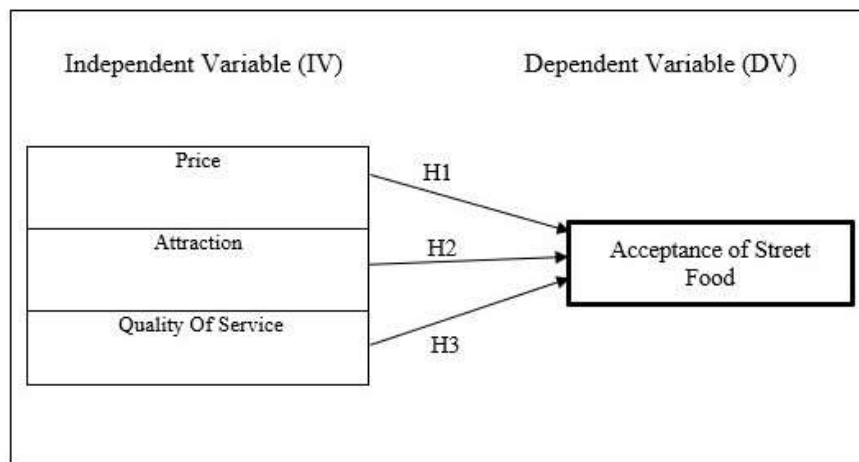

Figure 1: Conceptual Framework of the relationship between food price, service quality attraction

## METHODOLOGY

### Research Design

The research design is the framework that governs a researcher's approaches and actions in conducting a study. A descriptive study of students at the University of Malaysia Kelantan uses quantitative methodologies to solve research questions that require an explanation of patterns or the link between pricing, attraction, and quality of service. This design contributes to answering research questions and achieving research objectives.

### Population and sample size

The total number of students at City Campus is almost 10,971 students. Researchers choose university students at UMK City Campus as population researchers. This might necessitate choosing  $s$ , a sample size of only 370 students at UMK, City Campus according to the sample size from a given population (Krejcie & Morgan, 1970). The population size, or  $n$ , in this scenario is 10 000.

$N$	$S$	$N$	$S$	$N$	$S$
10	10	220	140	1200	291
15	14	230	144	1300	297
20	19	240	148	1400	302
25	24	250	152	1500	306
30	28	260	155	1600	310
35	32	270	159	1700	313
40	36	280	162	1800	317
45	40	290	165	1900	320
50	44	300	169	2000	322
55	48	320	175	2200	327
60	52	340	181	2400	331
65	56	360	186	2600	335
70	59	380	191	2800	338
75	63	400	196	3000	341
80	66	420	201	3500	346
85	70	440	205	4000	351
90	73	460	210	4500	354
95	76	480	214	5000	357
100	80	500	217	6000	361
110	86	550	226	7000	364
120	92	600	234	8000	367
130	97	650	242	9000	368
140	103	700	248	10000	370
150	108	750	254	15000	375
160	113	800	260	20000	377
170	118	850	265	30000	379
180	123	900	269	40000	380
190	127	950	274	50000	381
200	132	1000	278	75000	382
210	136	1100	285	100000	384

Note.— $N$  is population size.  
 $S$  is sample size.

Table 1: Sample size Krejcie & Morgan, 1970

The population of this study is the number of university students at Universiti Malaysia Kelantan, City Campus, who embrace street food. The total of students at City Campus is almost 10,971 students. Researchers choose university students at UMK City Campus as population researchers because street food makes it more attractive for their categories to hang out with their friends or close friends on weekends. A sample is a representative selection of a population. It is a smaller community with characteristics drawn from the population. Assumptions and observations made in relation to the sample data result are reflected in the population. The population sample size is 370 questionnaire responses from respondents. We must focus on a subset of that wider population because they would randomly accept it. This

might necessitate choosing a sample size of only 370 students at UMK, City Campus according to the sample size from a given population (Krejcie & Morgan, 1970). The population size, or  $n$ , in this scenario is 10,000.

### **Data Collection**

The method of data collecting utilized in the first step of this investigation was online surveys carried out with Google Forms. The researcher chose this collection of technological tools since it could be accessed without cost and was simple to operate. Additionally, it makes it simpler for the researcher to obtain data from students at the UMK City Campus. The questionnaire was likewise used as the primary data-gathering instrument in this study. A questionnaire is a tool used in research that consists of a series of questions to gather information from respondents through a survey. The respondents must respond to all three parts of this section. In order to obtain data from university students at the UMK City Campus, the questionnaire was made available to the general public.

The website's Google Form will contain the content of the research purpose for the respondents. There are four parts to the section that respondents need to tick for their answer, and the answer is the data that we collect for the research. The questionnaire is delivered to a number of university students in Malaysia about street food.

### **Sampling**

Sampling is a statistical approach in which researchers select a random sample of observations from a larger population. The sampling or selection of the sample used for the study is aimed to ensure that the sample is sufficiently representative to identify its characteristics and analyze the data (Shiksha, 2020). Sampling aims to acquire information from a smaller group that represents the overall population. Two significant categories of sampling methods can use, which are probability sampling and non-probability sampling. But in this study, the researchers chose cluster sampling-based probability sampling approaches. UMK students were the target population for the samples.

Using probability sampling techniques, all potential sample subjects in the target population have an equal chance of being chosen (Wretman, 2010; Moorley, 2014). This investigation selected a probability sampling strategy, such as cluster sampling, as the sample design. Form the clusters – a crucial step in ensuring the study's validity due to the meticulous analysis that ensures the elements represent the entire population in each and across the groups (Thomas, 2020).

### **Data Analysis**

The researcher gathered information from target respondents and analyzed it with the Statistical Package for Social Science (SPSS). SPSS is a data processing and analysis program that allows you to make tables and pie charts. The data analysis includes descriptive statistics, reliability tests, and Pearson correlations. All data analysis methods are discussed in the following subsection.

Descriptive statistics are used to explain the most important aspects of study data. The sample and measurements provided contain simple summaries and measures. They form the

basis for almost all quantitative data analysis and simple graphical analysis. In addition, descriptive data is used to convey information so that the research data generated can be used by others who need it. Test reliability is examined in terms of the items' general, group, and specific aspects, as well as the consistency scores in these factors, which vary from trial to trial. The degree of accuracy and reliability, or the consistency with which a test assesses a characteristic, is referred to as reliability. Moreover, according to (David Nettleton, 2014), the Pearson correlation method is the most popular technique for using numerical variables. It assigns a value between  $-1$  and  $1$ , where  $0$  is no correlation,  $1$  is positive, and  $-1$  is negative.

Pearson's correlation coefficient can be used to put to statistical test hypotheses because it is an inferential statistic. The test can also be used to determine whether or not there is a significant relationship between the two variables, which the researcher can determine.

## FINDINGS

### Result of Frequency Analysis

Table 2: Demographic Profile of Sample

Characteristics		Frequency	%
<b>Gender</b>	Male	78	21.08
	Female	292	78.92
<b>Age</b>	18 - 20	20	5.41
	21 - 23	283	76.49
	24 - 26	60	16.22
	27 and above	7	1.89
<b>Race</b>	Malay	325	87.84
	Chinese	18	4.86
	Indian	10	2.70
	Other	17	4.59
<b>Marital Status</b>	Single	362	97.84
	Married	8	2.16
<b>Educational Level</b>	Diploma	9	2.43
	Bachelor of Degree	344	92.97
	Master Degree	16	4.32
	Phd	1	0.27
<b>Faculty</b>	FKP	106	28.65
	FHPK	257	69.46
	FPV	7	1.89
<b>Programme</b>	SAB	35	9.46
	SAL	19	5.14
	SAR	25	6.76
	SAK	21	5.68
	SAE	6	1.62
	SAS	54	14.60
	SAP	69	18.65
	SAH	132	35.68
	SDV	9	2.43
<b>Year of Study</b>	Year 1	8	2.16
	Year 2	59	15.95
	Year 3	272	73.51
	Year 4	30	8.11

The age range of 21 to 23 years old had the most significant percentage of respondents, followed by the age range of 24 to 26 years old (16.22%), 18 to 20 years old (5.41%), and 27 years and older (1.89%). There were 370 respondents, with Malay people making up the majority (87.84%), followed by Chinese (4.86%), other races (4.59%), and Indians (2.70%). The most significant percentage of respondents with a Bachelor's degree was 92.97 percent, followed by 4.32 percent with a Master's degree and 0.27 percent with a PhD.

In addition, the Faculty of Hospitality, Tourism, and Wellness (FHPK) had the highest response rate (69.46%) with 257 respondents, followed by the Faculty of Entrepreneurship and Business (FKP) with 28.65 percent (106 respondents) and the Faculty of Veterinary Medicine with 1.89 percent (7 respondents). The Hospitality course had the highest percentage of respondents, followed by Islamic Banking and Finance, Logistics and Distribution, Retailing, Commercial, Wellness, Tourism, Veterinary, and Entrepreneurship. Overall, students in Year 3 had the most respondents.

### Result of Descriptive Analysis

Within the scope of this study, the mean and standard deviation were computed for the questionnaire sections B and C.

Tables 3: Descriptive Statistics

Variable	Items	Mean Score	Std. Deviation
<b>Food Price</b>	Buying street food is much cheaper than buying food at a restaurant/café	4.42	.766
	Street food prices are more reasonable	4.31	.815
	The price of street food is according to the student's income	4.33	.782
	Students can save money if they purchasing for street food and drinks	4.23	.887
	I'm willing to pay for street food and drink	4.29	.769
	With the price that is said to be reasonable, I am satisfied with the street food and drink	4.30	.720
<b>Attraction</b>	Street food is an attraction for me and my friends on weekends	3.81	1.110
	There are many types of food at street food	4.28	.897
	I'm going to tell my friend if I found a viral food place	4.24	.936
	I'm going to eat at a viral place	4.01	.979
	The variety of food is the main reason I buy the street food	4.26	.904
	I spend a lot of time at street food	3.77	1.160
	The street food service is very quick	4.10	.962



<b>Quality of Service</b>	The time it takes for the street food hawkers to prepare your food is quick	4.07	.924
	You don't have to rush to line up	3.52	1.085
	Quick food preparation makes you interested in buying street food	4.09	.905
	The street food hawkers give good service	3.98	.933
	Street food hawkers always take care of their quality service	3.77	1.022
	The hawkers behave by being kind, friendly, and fast in the service	3.95	.931
<b>Acceptance of Street Food</b>	I am satisfied buying food from the street hawkers	4.01	.865
	I am willing to buy this food again because of the taste of the food	4.13	.807
	Street food is cheaper than restaurant food	4.26	.822
	You can experience new and different foods in one place	4.24	.770
	I recommend street food to other people	4.18	.848

Food price was used as the independent variable in a mean and standard deviation analysis. At a mean of 4.42, most respondents agreed that buying meals from street food is significantly less expensive than eating out at a restaurant or cafe.

The analysis of the mean and standard deviation of the respondents' highest independent variable of attraction yielded a mean score of 4.25, indicating that students find street food appealing due to the variety of food available.

According to the analysis of respondents' means and standard deviations for the independent variable of quality of service, item 3 had the highest mean value of 4.09, suggesting that students' interest in purchasing street food is related to the quickness of its preparation.

The dependent variable is the mean and standard deviation analysis of respondents' acceptance of street food among university students at the UMK City Campus. Item 3 has the highest mean score, 4.26, indicating that respondents prefer street food because it is the cheapest and most affordable compared to restaurants and cafés.

## Result of Reliability Test

The purpose of a reliability system is to evaluate the overall stability and performance of a system over a specific time period and under various testing conditions. The result is being circulated to 370 students of UMK City Campus.

Table 4: Results of the Reliability Test

Variable	Number of items	Cronbach's Alpha coefficient	Strength of Association
Food Price	6	.920	Excellent
Attraction	7	.915	Excellent
Quality of Service	6	.922	Excellent
Acceptance of street food among university students	5	.918	Excellent

Cronbach's Alpha Coefficient values for the independent and dependent variables in this study are shown in Table 3. We may deduce from the table above that all the variables were more than 0.9. Consequently, the conclusion presented is reliable and may be accepted in this study. The food prices variable that influences university students' acceptance of street food on the UMK City Campus was measured with six items, and the Cronbach's Alpha for this section was 0.920, which is excellent. Therefore, the coefficients derived for the food price variable statement were trustworthy.

Following that, there were seven items in assessing an attraction variable that influences acceptance of street food among university students in UMK City Campus, and the result was .915, which is considered excellent. As a result, the coefficients calculated for attraction variables were reliable. In addition, the quality of service had the greatest impact on university students' acceptance of street food on the UMK City Campus, as measured by Cronbach's Alpha coefficient was .922. Consequently, the coefficients generated for the service quality variable item were reliable.

Finally, five items were utilized to assess the acceptance of street food among university students at UMK City Campus, and the Cronbach's Alpha result for this section was .918, indicating excellent. As a result, the coefficients are reliable. Since Cronbach's Alpha charge for the variables exceeded 0.7, it may be concluded that surveys are extremely trustworthy and that the study can proceed.

## Pearson Correlation

Pearson's correlation analysis was one of the most important analyses that examined the linear relationship between the two variables. This study aimed to see if there were any relationship between the independent variables (food price, attraction, and quality of service) and the dependent variables (acceptance of street food).

Tables 5: Pearson Correlation Analysis

Hypothesis	P-Value	Result (Support/Not Support)
H1: There is a relationship between food prices and acceptance of street food among university students in UMK City Campus	.556	H1 is supported
H2: There is a relationship between attraction and acceptance of street food among university students in UMK City Campus	.494	H2 is supported
H3: a relationship between service quality and acceptance of street food among university students in UMK City Campus	.540	H3 is supported

Table 5 shows the result of the Pearson Correlation Analysis. For food prices, the significant value, and the total number of respondents (370). The p-value was 0.000, which was less than the 0.01 level of significance. Food prices and the acceptance of street food among university students exhibited a moderate positive (negative) correlation value of 0.556.

Besides that, the p-value for the attraction and service quality was 0.000, which is less than the 0.01 level of significance. The correlation value of 0.494 revealed a low positive (negative) correlation between attraction and acceptance of street food. In contrast, the correlation between service quality and street food acceptance is a moderate positive (negative) correlation value of 0.540.

## DISCUSSION AND RECOMMENDATIONS

As a result of urban dietary trends, street foods are widely consumed and manufactured in practically every country across the world. Consumers, particularly students, prefer street food because of its great taste, accessibility, variety, and low cost. In one study, students like to eat street foods regularly for economical and fast service reasons, while knowing that these items are unhealthy and have little nutritional value—the study analyzed the relationship between food price, attraction and quality of service factors. This study aims to determine the relationship between food price, attraction, quality of service, and students' acceptance of street food.

According to this study, the majority of respondents between 21-23 years old consisting in Malay with a mean score of 4.42, agreed that purchasing meals from street food is much less expensive than eating out at a restaurant or café since it is the lowest and most economical option when compared to restaurants and cafés. According to consumer surveys on buying motivations, food price, flavour, and convenience are among the most important variables influencing their meal choices. This is especially true for students from low-income families. Several socio-anthropological research has found that food prices have a greater influence on student purchasing decisions. According to Tiwari and Verma (2008), the reasons for the expansion of the street food business include the low prices and convenience of producing routinely marketed food.

The analysis of the mean and standard deviation of the respondents' highest independent variable of attraction yielded a mean score of 4.25, and students enjoy street food because of the diversity of foods offered. This is because students like to choose the food they want when selecting street food according to their taste.

Students' interest in purchasing street food is also tied to the speed with which it is prepared had the highest mean value of 4.09. Understanding and defining the important features are critical to shed some light on consumer behavior (Ibáez Casanova, 2003). The quality of service's acceptance depends on how customers view and evaluate the service or product. According to Grunet (2010), quality is a criterion generated by the buyer before making the purchase and after consuming the products. The study went on to say that it is generally accepted that consumer perceptions of products. The quality of service provided is important for indoor and outdoor food, with the latter represented by street commerce. Customers' perceptions of ultimate quality are frequently the consequences of their decisions between their expectations before purchasing the goods and the performance (taste) (Tinoco & Ribeiro, 2008).

Because the study's population consisted of young consumers among university students, the findings cannot be generalized to all consumers or all ages. Conducting the study on a big sample of consumers of all ages would be beneficial. Although the reliability coefficient discovered was high, interpretation of the results is limited due to self-reported responses, which are vulnerable to subject bias. More testing and observational studies are required to validate instruments for consumers of all ages. The limitation of this research is the respondents. Even though this research collected 370 respondents, most answered the survey

by Malays, followed by Chinese, Indian, and others. Possibility factors influencing are not equally distributed to all races in Malaysia. So, it is suitable for future research to distribute the survey equally to all races. This research focuses on how exogenous variables (food price, attraction and service quality) influence street food acceptance among university students. Moreover, future research should focus only on specific groups of users.

## **CONCLUSION**

The acceptance of street food among university students at the University Malaysia Kelantan City Campus was investigated in this study. As a result, the study's contributions stem from its theoretical addition to knowledge and practical application to street food. This study looks into the elements that influence food price, attraction, and service quality in the acceptance of street food. Even though many research has been conducted, it is uncommon to find particular types of street food. From a knowledge standpoint, this study will reveal the most prevalent element in university students' acceptance of street food. The research was carried out to gather fresh understanding and additional information. This study would also contribute to the theoretical perspective from what has been learned in research.

Moreover, through this study, the vision of acceptance of street food among university student in University Malaysia Kelantan, City Campus could be identified. This study's result can reveal why students will re-patronage the same street food all over again because of food price, attraction and quality of service. Thus, street food sellers should concentrate their efforts on personal hygiene and training - both related to the service component in the research - and should depict the image of their products as healthy because healthy items are associated with product quality.

## REFERENCE

- Abd, F., Sadri, N., Qamar, N., & Yusup, B. (2021b). Customers' Perception on Malaysian Street Food Quality. *International Journal of Academic Research in Business and Social Sciences*, 1(13), 73–87. <https://doi.org/10.6007/IJARBSS/v11-i13/8503>
- Abdullah, D., Ismail, S., & Mohamed, B. (2020, July). *The Influence Of Food Quality, Service Quality, Fair Price And Customer Satisfaction On Re-Patronage Intention Towards Halal Certified Restaurants*. [https://www.researchgate.net/publication/342945333\\_The\\_Influence\\_Of\\_Food\\_Quality\\_Service\\_Quality\\_Fair\\_Price\\_And\\_Customer\\_Satisfaction\\_On\\_Re-Patronage\\_Intention\\_Towards\\_Halal\\_Certified\\_Restaurants](https://www.researchgate.net/publication/342945333_The_Influence_Of_Food_Quality_Service_Quality_Fair_Price_And_Customer_Satisfaction_On_Re-Patronage_Intention_Towards_Halal_Certified_Restaurants)
- Akter, M., Sadekin, M. N., & Patwary, A. K. (2020). An Empirical Study on Students' Satisfaction from Mawlana Bhashani Science & Technology University, Bangladesh. *Review of Economics and Development Studies*, 6(2), 363-379.
- Alom, S., Patwary, A. K., & Khan, M. M. H. (2019). Factors affecting the turnover intention of Bangladeshi migrants in the United Arab Emirates: An empirical study on the hotel industry. *International Journal of Innovation, Creativity and Change*, 8(3), 344-360.
- Fengmin, Z., Baijun, W., Jiangtao, B., Li, L., & Patwary, A. K. (2022). Investigating revisit intention of medical tourists in China through nutritional knowledge, perceived medical quality, and trust in the physiologist: A recommendation on health tourism policy measures. *Frontiers in Public Health*, 10, 893497.
- Hazbar, A. M. H., Alem Mohammed, A., & Karim, A. K. A. (2019). An Empirical Study of Factors Influencing hotel customers' online booking Intention. *مجلة العلوم التربوية و الدراسات الإنسانية*, (5), 1-17.
- Li, L., Ragavan, N. A., Patwary, A. K., & Baijun, W. (2022). Measuring patients' satisfaction toward health tourism in Malaysia through hospital environment, nutritional advice, and perceived value: A study on Chinese exchange students. *Frontiers in public health*, 10, 893439.
- Li, L., Wu, B., & Patwary, A. K. (2022). How marine tourism promote financial development in sustainable economy: new evidences from South Asia and implications to future tourism students. *Environmental Science and Pollution Research*, 29, 1155-1172.
- Li, L., Wu, B., & Patwary, A. K. (2022). The psychosocial factors affecting chinese Outbound Exchange and mobility students' academic performance during COVID-19. *Frontiers in psychology*, 13, 872516.
- Patwary, A. K., Roy, B., Hoque, R., & Khandakar, M. S. A. (2019). Process of developing a community based tourism and identifying its economic and social impacts: An Empirical study on Cox's Bazar, Bangladesh. *Pakistan Journal of Humanities and Social Sciences*, 7(1), 1-13.
- Sanlier, N. (2016, September 17). *A study about the young consumers' consumption behaviors of street foods*. TEMAS LIVRES FREE THEMES. [file:///C:/Users/USER/Downloads/A\\_study\\_about\\_the\\_young\\_consumers\\_consumpti\\_on\\_beh.pdf](file:///C:/Users/USER/Downloads/A_study_about_the_young_consumers_consumpti_on_beh.pdf)
- Sumethokula, P., Patwary, A. K., Srinuanpanc, B., Srinuanpand, C., Suwandee, P., Thammathikul, A., & Phanong, W. (2020). The potential of new tour repackaging for creative tourism among entrepreneurs in Nakhon Si Thammarat. *International Journal of Innovation, Creativity and Change*, 13(10), 1752-1771.
- Wu, B., Liu, S., Wang, J., Tahir, S., & Patwary, A. K. (2021). Assessing the mechanism of energy efficiency and energy poverty alleviation based on environmental regulation policy measures. *Environmental Science and Pollution Research*, 28, 40858-40870.

Wu, B., Zhai, B., Mu, H., Peng, X., Wang, C., & Patwary, A. K. (2021). Evaluating an economic application of renewable generated hydrogen: A way forward for green economic performance and policy measures. *Environmental Science and Pollution Research*, 1-15.

# FACTORS AFFECTING CONSUMER PREFERENCE TO USE ONLINE FOOD DELIVERY SERVICES IN MALAYSIA

**Nur Syazwina Binti Dollah , Nurain Binti Abdul Muti, Nurain Nabila Binti , Nuraina  
Nadia Binti Adnan & \*Nurul Fardila Abd Razak**

*Faculty of Hospitality, Tourism and Wellness, University Malaysia Kelantan  
Corresponding email: fardila.ar@umk.edu.my*

## **ABSTRACT**

*The food delivery service business in Malaysia and globally is experiencing significant growth, with customers increasingly seeking takeaway food delivery. The study's objective is to identify variables influencing Malaysian consumers' preferences for food delivered online. This study examines factors affecting consumer preference for online food delivery services in Malaysia. A quantitative research approach, using 384 questionnaires distributed via social media and SPSS software, revealed a positive relationship between online food delivery services with convenience motivation, perceive risk and perceive ease of use. The investigation's design, population of interest and size of the sample, method of sampling, collecting data processes, instruments for research, and data analysis was covered. The findings provide implications and recommendations for future researchers to conduct similar studies in Malaysia.*

**Keyword:** Online Food Delivery Service, Convenience Motivation, Perceive Risk, Perceive Ease of Use.

## **INTRODUCTION**

Malaysia markets for food delivery services are currently expanding and has a high potential rate. The demand for online food delivery (OFD) services has expanded by bringing customers' food to their doorstep as businesses struggle to find strategies to survive (NPD, 2020). Online food delivery (OFD), as defined by Li et al. (2020), is the practise of having customers order food online and have it delivered to them by riders. Since 2012, Foodpanda has been the first OFD app in Malaysia, followed by DeliverEat, Honestbee, Dahmakan, Grab food, and Lala food (Pang, 2017).



These applications are all competitive in offering user delivery services (Kong & Bizhive, 2018). The demand for OFD increased especially in the new norm of the Covid-19 pandemic. In recent years, the Covid-19 pandemic has changed the landscape of business operations, which are heavily dependent on transactions and the use of the internet has increased rapidly. (Alaimo & Galati, 2020). The study's objective is to identify variables influencing Malaysian consumers' preferences for food delivered online.

The research objectives in this study are as follows:

1. To determine the relationship between the perceived risk towards consumer preference to use online food delivery services.
2. To determine the association between perceived ease of use and the preference of consumers for using online meal delivery services.
3. To determine the connection between consumer desire for using online meal delivery services and the motivation of convenience.

## **Significance of the Study**

### **Consumer**

This beneficial contribution can be interpreted as arguing that the majority of customer fulfilment has a favourable impact on delivery service because it is simple and easy for them, variety of options, and time saving especially in the present context where people are required to stay inside due to the emergency. This generation of customers is more likely to order a wide selection of instantly accessible dishes through food delivery services from their preferred eateries. And delivery companies are continuously creating new ordering channels to make things simpler and easier in an effort to keep the millennials interested and enticed.

## **Researchers**

The findings of the study will benefit researchers who want to research and find more information about online food delivery (OFD) services in Malaysia because it provides knowledge and knowledge. As a result of online food delivery (OFD) is now a growing the Malaysian trend especially in the new norm of covid 19, it attracts many researchers to conduct research on this topic.

## **Online Food Delivery**

The well-known Grab Company, which delivers e-hailing services, includes Grab Food. The Grab Food Delivery service enables customers to place online orders for delivery from restaurants that are close to the delivery address. Next, Food Panda because they provide food to practically everyone in the nation, this panda is quite well-known in Malaysia. For restaurants in the vicinity of the delivery address, the business offers food delivery services

## **LITERATURE REVIEW**

### **Convenience Motivation**

Compland (1923) and Kimes (2011) both found that One of the primary motivations for users to accept electronic technology is convenience. Online takeout ordering provides several benefits, avoiding bad customer service and lowering in-store traffic are two examples. Convenience of time and effort are important factors influencing consumer adoption of OFD services, and shoppers who prioritize convenience will always take their time and try to cut costs (Collier & Kimes, 2013). Therefore, convenience motive influences online food buyers' behavior in a good way.

### **Perceive Risk**

Food safety risk perception (FSRP) is the term for the perceived danger connected to eating and is critical for customers' purchasing decisions (Nardi, Teixeira, Ladeira, & de Oliveira Santini, 2020).

Depending on the selling site, customers may have various FSRP. The food provided by OFD services can be contaminated because the delivery operation makes it difficult for this service to maintain the safety and cleanliness of the food for the consumer. Customers may therefore see a higher FSRP when utilising OFD because they cannot personally inspect the cleanliness of the restaurant and staff, which can be detrimental to CIU. The following theory is presented based on previous studies about FSRP and the characteristics of OFD services.

### **Perceive Ease of Use**

According to Pinho and Soares, perceived ease of use (PEOU) refers to how much a person expects to have psychological or physical issues when using new technology. Studies have shown that PEOU significantly affects customers' propensity to use a range of technologies. Consumers are ready to accept purchases made online., according to Ignatius and Ramayah's 2005 research, if smartphone and web interfaces are simple to use and require minimal effort. Consumers are more inclined to use OFD services if their PEOU is higher, boosting their odds of success, according to Roh and Park's 2019 research. By highlighting the crucial roles that the ordering process, order tracking, and filtering options of the interface played in establishing CIU, Ray et al. 2019 emphasize the significance of PEOU of OFD services.

### **Online Food Delivery Services**

Online food delivery is the procedure used to make and deliver the user's online-purchased meal (OFD) (Li et al., 2020). Using an OFD service platform on its website or mobile application, a customer can place meal orders from numerous restaurants. The market for OFD services is forecast to reach \$182.3 billion in 2019 and has gained greater attention since the COVID-19 outbreak due to its contactless ordering and delivery approach. OFD services' influence the ability of the food and beverage industry to expanding businesses, OFD is forecast to increase by RM599 million in 2019. This is due to the government's movement control order, the recent sickness issue, and countries opening for commercial activities. Online business has been booming, influencing customer satisfaction and experience. According to a study by the NPD Group, the number of

orders for off-road vehicles rose 67% in March 2020 compared to March 2019. Academics have studied how OFD customers make decisions and their behavioral goals (Yeo et al,2017).

### Research Hypothesis

The purpose of the study is to determine whether dependent and independent variables have any correlations or relationships:

**H1 :** There is a significant relationship between the convenience motivation towards consumer preference to use online food delivery services.

**H2 :** There is a significant relationship between the perceived risk towards consumer preference to use online food delivery services.

**H3 :** There is a significant relationship between the perceived ease of use towards consumer preference to use online food delivery services.

### Research Framework

This study highlighted a conceptual framework that examines what influences customers' preference for using online food delivery services. Three independent variables have been used in this study which are convenience motivation, perceive risk and perceived ease of use.

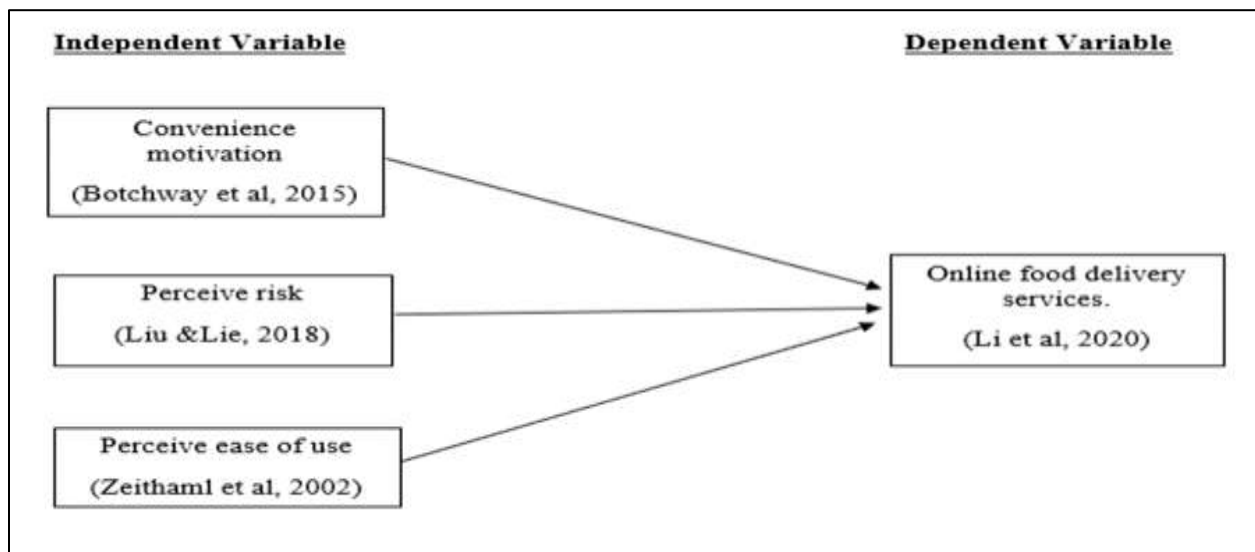

Figure 1 Conceptual Framework

## **METHODOLOGY**

### **Research design**

Data were collected for this study utilizing a quantitative method and questionnaires. 384 Malaysians in all responded to the survey. In addition, the research design gave a summary of the study and identified the data that was being examined. This approach was mostly used by the researcher to generate information through experiments, surveys, and data collection through preset instruments.

### **Data Collection**

The data were gathered through field research. The Google online form tool were used to disseminate the surveys for this research. Every social media platform, including Instagram, Facebook, WhatsApp, email, received the link to the Google form. To gather the survey's data, a series of questionnaires were given to the 384 respondents. The questionnaire made use of modified 5-Likert scales and multiple-choice formats. The questionnaire included four sections and was written in both English and Malay. The questionnaires are divided into Sections A, B, and C. Section A were demographic profiles which are gender, age, marital status, occupation, and income. Independent variables made up Section B, whereas dependent variables made up Section C.

### **Sampling**

The non-probability sampling technique was employed in this research. Since it was simple to use and included a quick research response, this kind of sampling approach was chosen. Non-probability sampling techniques like convenience sampling are affected by data collection from populations that are easily available and eager to take part in the research. The researchers calculated the sample size to obtain a representative sample that is both valid and trustworthy for this study. In a nutshell, 384 individuals would make up the sample according to the generalization made by Krejcie & Morgan (1970).

## Data Analysis

Analysis by frequency, description, reliability, and the four data analysis techniques employed in this study were Pearson's correlation analysis. The data were examined using the Statistical Package for the Social Sciences (SPSS) that had been collected. The demographic information from the respondents was analyzed using frequency. In Malaysia, descriptive analysis is used to determine and look at customer preferences for using OFDS. The reliability test was performed to determine the extent to which an evaluation procedure produces reliable findings. The association between convenience motive, perceived risk, and perceived ease of use on consumer preference to use OFDS in Malaysia was investigated using Pearson's Correlation.

## FINDINGS

### Result of Descriptive Analysis

Table 1 below shows what examination of the descriptive data showed

Table 1: Descriptive Analysis

<b>Variable</b>	<b>Items</b>	<b>Mean Score</b>	<b>Standard Deviation</b>
<b>Convenience Motivation</b>	OFDS allow me to order food panda any time.	4.25	0.768
	OFDS allow me to order food panda any place.	4.23	0.816
	OFDS make my daily life easier	4.32	0.726

	I can get my food with (OFDS) without leaving home	4.40	0.720
	I like to order food without leaving home	4.18	0.882
<b>Perceive Ease of Use</b>	I would find that it easy to use OFDS.	4.24	0.686
	I believe that using OFDS requires minimum effort.	4.21	0.734
	I believe it's easy to learn about online food ordering.	4.33	0.671
	I think that is easy to navigate through online food ordering platform.	4.32	0.715
	I found the OFDS platform is easy to use everywhere.	4.36	0.716
<b>Perceive Risk</b>	I worried of (OFDS) online purchases and concern about my credit card security.	3.62	0.894
	I wonder if the product will be as good as it is advertised to be.	3.78	0.951

I wonder if the food doesn't reach my expectation.	3.85	0.964
I am concerned of using OFDS weither my information won `t be protected.	3.72	0.942
I am worried of using OFDS if my personal information will be hacked.	3.76	0.920

Table 1 show the mean and standard deviation for the used to measure the convenience motivation, perceive ease of use and perceive risk . There were 5 question measured for all variable. For variable convenience motivation had the highest mean, 4.40 on the statement “I can get my food with (OFDS) without leaving home”. However, it was measured with the lowest mean which is 4.18 on the statement “I like to order food without leaving home”. For variable perceive ease of use had the highest mean, 4.36 on the statement “I found the OFDS platform is easy to use everywhere”. However, it was measured with the lowest mean which is 4.21 on the statement “ I believe that using OFDS requires minimum effort”. For variable perceive risk had the highest mean, 3.85 on the statement “I wonder if the food doesn't reach my expectation”. Meanwhile , it was measured with th lowest mean which is 3.62 on the statement “I worried of (OFDS) online purchases and concern about my credit card security”.

### **Result of Reliability Analysis**

Table 2 The results of the reliability analysis are shown in the section below.



Table 2 : Reliability Analysis

Variables	Number of Items	Cronbach's Alpha
Convenience Motivation	5	0.833
Perceive ease of use	5	0.893
Perceive risk	5	0.893
Online Food Delivery Services	5	0.803

According to Table 2 above, the results for the pilot test for each section of the questionnaire are acceptable because all the values are more than 0.800 Cronbach's Alpha. In this study, there were five questions used to measure the variables. The first independence variable, which Convenience motivation is 0.833 which resulted as good strength of association. The second independence variable, perceived ease of use is 0.893 which resulted in a very good strength of association. Next, perceive risk also 0.893 which is a good strength of association. Lastly, with regard to the dependent variable that is online food delivery services, is 0.803 which resulted in a good strength of association and all the variables had valid questions.

### Result of Pearson Correlation Analysis

Table 3: Pearson Correlation Analysis

Hypothesis	P-Value	Result (Supported/Not Supported)
H <sub>1</sub> : The connections between are highly significant. Convenience is a driving factor behind consumer intent to use online food delivery services.	0.459	H <sub>1</sub> is supported

---

**H<sub>2</sub>:** There is a significant relationship between perceived risk 0.535 H<sub>2</sub> is supported towards customer intention to use online food delivery services.

---

**H<sub>3</sub>:** There is a significant relationship between perceived ease of use 0.055 H<sub>3</sub> is supported towards customer intention to use online food delivery services.

---

As can be seen from Table 4, the results of hypothesis testing are reported based on a significant relationship between the convenience motivation, perceived risk and perceived ease of use. overall, these results indicate that all the hypotheses were accepted at 0.001 significance level.

## **DISCUSSION AND RECOMMENDATION**

Studies that have been implemented to some extents have presented challenges to researchers. One of the limitations of this study was that the researcher experienced problems in obtaining data from respondents. Not all residents know about OFDS, and online delivery services are usually available in cities. Consumers may show different attitudes, subjective norms, and perceptions governing their behavior compared to of purchase intent those living in urban areas. Therefore, the generalization of findings to wider populations across countries should be done with caution.

Researchers struggle with online data collection due to the fact that respondents who still have questions about the questionnaire are less likely to receive assistance. The questionnaire distributor was not physically there to assist respondents in seeking clarification if they had any questions, so many individuals will scan through the questionnaire on social media and disregard it. This is because if respondents are unsure about the questionnaire, they are unlikely to contact us or seek assistance, leading to erroneous data from respondents. Additionally, some respondents like in-person interviews with the interaction between the two parties or question-and-answer sessions.

The majority of people are not interested in responding to questions, so posting and sharing them online does not boost the response rate.

The limitation of the study was inaccurate and non-relevant data from respondents. The scope and generality of this investigation are too large. This is because the study doesn't concentrate on just one OFD platform. This makes it difficult to get data from consumers of OFDS. Some of the respondents are Foodpanda, GrabFood, and other OFD platform consumers, while others don't use any of these platforms at all. Due to issues with differing degrees of knowledge, the assessment offered by the respondents may not be correct. We still don't know how the questionnaire's questions were received by the respondents.

It is a non-random strategy that doesn't call for any fundamental ideas or a predetermined quantity of players. In short, researchers determine the information needed and then find people who can and will supply it based on their knowledge (Bernard et al., 2002).

To secure an adequate number of respondents, the researcher will advise future researchers to switch from convenience sampling to purposive selection. Purposive sampling, also known as probability sampling, is a deliberate selection of a person based on individual traits (Ilker Etikan, 2016). It is a non-random technique that does not require any fundamental principles or a specific number of participants. In summary, researchers identify the information that is required and then seek out people who can and will provide it based on their knowledge (Bernard et al., 2002). It is frequently used in quantitative research to identify and choose the most information-rich samples in order to make the best use of limited resources (Patton et al., 2002). This goal is mainly concerned with usage.

Another idea is to conduct this study over a longer period of time and to include more independent factors. This study will now concentrate on three independent variables: Convenience Motivation, Perceived Ease of Use, and Perceived Risk. better suggestions for improving the study can be made, such as having similar large organizations or those who operate online food delivery services explore rural areas to further grow this platform and make it better known to the public and those who reside outside of the city. This will aid in the collection of further data and the completion of a study on the factors influencing the adoption of online meal delivery services in Malaysia.

## CONCLUSION

To conclude, these three elements that influence a consumer's decision to utilise Malaysian online delivery of food are perceived risk, perceived ease of use and convenience motivation. Researchers will gain a better understanding of Malaysian consumers' preferences for food delivered via the internet according to the study's findings. All the variables are related to each other that will bring effects in factor of consumers preference towards online food delivery services. Future studies should prioritize using a population sample that is fairly balanced. The results of an unbalanced sample will be inconsistent and will only favor one group. After that, the sample size must be increased to produce accurate, precise, and reliable outcomes. Researchers could look into incorporating other variables to uncover additional elements influencing Malaysian consumers' preference

## REFERENCES

- Akter, M., Sadekin, M. N., & Patwary, A. K. (2020). An Empirical Study on Students' Satisfaction from Mawlana Bhashani Science & Technology University, Bangladesh. *Review of Economics and Development Studies*, 6(2), 363-379.
- Alom, S., Patwary, A. K., & Khan, M. M. H. (2019). Factors affecting the turnover intention of Bangladeshi migrants in the United Arab Emirates: An empirical study on the hotel industry. *International Journal of Innovation, Creativity and Change*, 8(3), 344-360.
- Author links open overlay panelChanmiHongPersonEnvelopeHayeon (Hailey)ChoiEnvelopeEun-Kyong (Cindy)ChoiEnvelopeHyun-Woo (David)JoungEnvelope *et al.* (2021) *Factors affecting customer intention to use online food delivery services before and during the COVID-19 pandemic*, *Journal of Hospitality and Tourism Management*. Elsevier. Available at: <https://www.sciencedirect.com/science/article/pii/S1447677021001339>
- Author links open overlay panelVincent Cheow SernYeoEnvelopeSee-KwongGohEnvelopeSajadRezaeiPersonEnvelope *et al.* (2016) *Consumer experiences, attitude and behavioral intention toward online food delivery (OFD) services*, *Journal of Retailing and Consumer Services*. Pergamon. Available at: <https://www.sciencedirect.com/science/article/abs/pii/S0969698916302855>
- Fengmin, Z., Baijun, W., Jiangtao, B., Li, L., & Patwary, A. K. (2022). Investigating revisit intention of medical tourists in China through nutritional knowledge, perceived medical quality, and trust in the physiologist: A recommendation on health tourism policy measures. *Frontiers in Public Health*, 10, 893497.

- Foodpanda.* (2022). Available at: <https://www.foodpanda.my/contents/about.htm#:~:text=foodpanda%20Malaysia%20was%20 established%20in,in%20the%20past%203%20 years>
- Grab for business – corporate food* (2022) *Grab MY.* Available at: <https://www.grab.com/my/business/food/?utm>
- Grunert, K.G. and Ramus, K. (2005) *Consumers' willingness to buy food through the internet: A review of the literature and a model for future research*, *British Food Journal*. Emerald Group Publishing Limited. Available at: <https://www.emerald.com/insight/content/doi/10.1108/00070700510602174/full/html>
- Hazbar, A. M. H., Alem Mohammed, A., & Karim, A. K. A. (2019). An Empirical Study of Factors Influencing hotel customers' online booking Intention. *مجلة العلوم التربوية و الدراسات الإنسانية*, (5), 1-17.
- Hong, C., Choi, H. H., Choi, E.-K. C., & Joung, H.-W. D. (2021). Factors affecting customer intention to use online food delivery services before and during the COVID-19 pandemic. *Journal of Hospitality and Tourism Management*, 48, 509-518. <https://www.sciencedirect.com/science/article/pii/S1447677021001339>
- How can I get foodpanda delivery* (2022) *Food and grocery delivery in Malaysia | Order online on foodpanda.* Available at: <https://www.foodpanda.my/>
- J., B. (2022) *Attitude toward food in aspect of risks and benefits related to the consumption of edible insects by Polish consumers*, *Roczniki Panstwowego Zakladu Higieny*. U.S. National Library of Medicine. Available at: <https://pubmed.ncbi.nlm.nih.gov/32227785/>
- Li, L., Ragavan, N. A., Patwary, A. K., & Baijun, W. (2022). Measuring patients' satisfaction toward health tourism in Malaysia through hospital environment, nutritional advice, and perceived value: A study on Chinese exchange students. *Frontiers in public health*, 10, 893439.
- Li, L., Wu, B., & Patwary, A. K. (2022). How marine tourism promote financial development in sustainable economy: new evidences from South Asia and implications to future tourism students. *Environmental Science and Pollution Research*, 29, 1155-1172.
- Li, L., Wu, B., & Patwary, A. K. (2022). The psychosocial factors affecting chinese Outbound Exchange and mobility students' academic performance during COVID-19. *Frontiers in psychology*, 13, 872516.
- Malaysia online food delivery market by type and region Global Forecast 2021 to 2028.* (2019) *Adroit Market Research.* Available at: <https://www.adroitmarketresearch.com/industry-reports/malaysia-online-food-delivery-market>
- Online food delivery services: Making food delivery the new normal* (2019). Available at: [https://www.researchgate.net/profile/Teck-Chai-Lau-2/publication/334050513\\_Online\\_Food\\_Delivery\\_Services\\_Making\\_Food\\_Delivery\\_the\\_New\\_Normal/links/5d148043458515c11cfb6d5e/Online-Food-Delivery-Services-Making-Food-Delivery-the-New-Normal.pdf](https://www.researchgate.net/profile/Teck-Chai-Lau-2/publication/334050513_Online_Food_Delivery_Services_Making_Food_Delivery_the_New_Normal/links/5d148043458515c11cfb6d5e/Online-Food-Delivery-Services-Making-Food-Delivery-the-New-Normal.pdf)

- panelYuyangZhaoPersonEnvelopeFernandoBacaoEnvelope, A.links open overlay *et al.* (2020) *What factors determining customer continuingly using food delivery apps during 2019 Novel coronavirus pandemic period?*, *International Journal of Hospitality Management*. Pergamon. Available at: [https://www.sciencedirect.com/science/article/pii/S0278431920302358?casa\\_token=35pq5TUzEo4AAAAA%3ApYZ0rMEbwF-vNNZ1rxDE\\_dCTQ9Lkui5oJu58ADFA5NdLVaGzX5SyXmBD2Tzbn3AjZNdMGYeS3H8j](https://www.sciencedirect.com/science/article/pii/S0278431920302358?casa_token=35pq5TUzEo4AAAAA%3ApYZ0rMEbwF-vNNZ1rxDE_dCTQ9Lkui5oJu58ADFA5NdLVaGzX5SyXmBD2Tzbn3AjZNdMGYeS3H8j)
- Patwary, A. K., Roy, B., Hoque, R., & Khandakar, M. S. A. (2019). Process of developing a community based tourism and identifying its economic and social impacts: An Empirical study on Cox's Bazar, Bangladesh. *Pakistan Journal of Humanities and Social Sciences*, 7(1), 1-13.
- Prasetyo, Y. T., Tanto, H., Mariyanto, M., Hanjaya, C., Young, M. N., Persada, S. F., Redi, A. A. N. P. (2021). Factors affecting customer satisfaction and loyalty in online food delivery service during the COVID-19 pandemic: Its relation with open innovation. *Journal of Open Innovation: Technology, Market, and Complexity*, 7(1), 76. <https://www.mdpi.com/2199-8531/7/1/76>
- Ross, I. (1975) *>perceived risk and consumer behavior: A critical review: ACR, ACR North American Advances*. Available at: <https://www.acrwebsite.org/volumes/5741/volumes/v02/NA-02>
- Sumethokula, P., Patwary, A. K., Srinuanpanc, B., Srinuanpand, C., Suwandee, P., Thammathikul, A., & Phanong, W. (2020). The potential of new tour repackaging for creative tourism among entrepreneurs in Nakhon Si Thammarat. *International Journal of Innovation, Creativity and Change*, 13(10), 1752-1771.
- Take online courses. earn college credit. Research Schools, Degrees & Careers* (2023) *Study.com* | *Take Online Courses. Earn College Credit. Research Schools, Degrees & Careers*. Available at: <https://study.com/academy/lesson/convenience-sampling>
- Tan, S. Y., Lim, S. Y., & Yeo, S. F. (2021). Online food delivery services: cross-sectional study of consumers' attitude in Malaysia during and after the COVID-19 pandemic. *F1000Research*, 10(972), 972. <https://f1000research.com/articles/10-972>
- Tan, S.Y., Lim, S.Y. and Yeo, S.F. (2021) *Online food delivery services: Cross-sectional study of consumers' attitude in Malaysia during and after the COVID-19 pandemic, F1000Research*. F1000 Research Limited. Available at: <https://f1000research.com/articles/10-972>
- Wu, B., Liu, S., Wang, J., Tahir, S., & Patwary, A. K. (2021). Assessing the mechanism of energy efficiency and energy poverty alleviation based on environmental regulation policy measures. *Environmental Science and Pollution Research*, 28, 40858-40870.
- Wu, B., Zhai, B., Mu, H., Peng, X., Wang, C., & Patwary, A. K. (2021). Evaluating an economic application of renewable generated hydrogen: A way forward for green economic performance and policy measures. *Environmental Science and Pollution Research*, 1-15.

# **The Influence of Youngster's Satisfaction Towards Hipster Food in Kota Bharu, Kelantan**

**Nurdyiana Binti Zambri, Nurhasidah Binti Wahab, Nurnadiah Binti Bahren, Nurul Ain Natasya Amirah Binti Ismail & Nurul Fardila Binti Abd Razak**

*Faculty of Hospitality, Tourism and Wellness, Universiti Malaysia Kelantan*

*Corresponding email : [fardila.ar@umk.edu.my](mailto:fardila.ar@umk.edu.my)*

---

## **ABSTRACT**

Hipster food in Malaysia is a recent invention that has been adapted from diverse concepts, distinctive flavors, and culinary traditions of western nations that are currently popular among young people. The objective of this study is to identify the variables that influence young people towards hipster food in Kota Bharu, Kelantan. This study examines the factors of consumer satisfaction with, food quality, service quality and the environment of hipster food restaurants studied in this research. A quantitative research approach, using 384 questionnaires revealed through social media and SPSS software, revealed a positive relationship between young people's satisfaction with hipster food and food quality, service quality and environment of hipster food restaurants. The research design, population of interest and sample size, sampling method, data collection process, instruments for research, and data analysis were obtained. The researcher will then be able to determine the main influence of customer satisfaction, especially among young people, towards hipster food in Kota Bharu, Kelantan, using the survey data at the end of the research. Future research ideas will be presented.

**Keywords:** Youngster's, satisfaction Hipster food, Service Quality, Food Quality, Restaurant Environment

---

## INTRODUCTION

The global food service is one of the fastest expanding markets in the world, with 167,490 food service establishments in 2015, up from 130,570 in 2010. This is due to positive socioeconomic conditions, demographic changes, alterations in consumer food preferences, and an increase in demand (Mohd Zahari et al,2011). Fast food and hipster cuisine have gained popularity due to the lack of time in the hectic, competitive, and fast-paced metropolitan life. The hipster food scene in Malaysia has given rise to a new obsession, and its influence on people's eating and lifestyle choices is not limited to food (Platania and Donatella,2003). In Kota Bharu, Kelantan, there are more than 15 hipster-themed eateries, cafes, and retail establishments that are distinctive and draw customers. Youngsters are more attracted to the development of the latest issues, especially in terms of cultural changes, food consumption, and the concept of constantly innovating the menu in order to make the dishes become popular and cool to attract customers. A study on the satisfaction of hipster food in the young generation in Kota Bharu, Kelantan was conducted, and young people who reside in and around Kota Bharu, Kelantan find it extremely rewarding and fascinating that the younger generation has accepted hipster food innovation. However, the purpose of this research is to measure the consumer satisfaction toward hipster food in Kota Bharu, Kelantan. The research objectives in this study are as follows:

1. To determine the relationship between food quality towards hipster food in Kota Bharu, Kelantan.
2. To examine the relationship between service quality towards hipster food in Kota Bharu, Kelantan.
3. To examine the relationship between restaurant environments towards hipster food in Kota Bharu, Kelantan.



## **SIGNIFICANCE OF STUDY**

### **To entrepreneurs' café**

This study provides information on the factors that motivate consumers, particularly the youngsters, to be satisfied with hipster foods. The result will enable the entrepreneurs to improve the second-rate of preparing the hipster food to the consumers. Data gathered will help the entrepreneurs to create a value for the customer in order to achieve customers' confidence and trust.

### **The consumers/customers**

The results of the study will help the consumer evaluate the quality of service, food and the restaurant environment that is provided by the hipster cafes. This study could also represent the customers on what kind of expectation that should be standardized by the entrepreneurs when preparing the foods in order to build customers loyalty towards the new food innovation, food hipster.

### **The researchers**

Through this study, the researchers were able to understand more about food innovation, food hipster. This study also helped the researchers to identify reasons on how entrepreneurship deals with consumers' preference. Besides, this study also could inspire other researchers to conduct a similar or additional research in a different geographical area.

## **LITERATURE REVIEW**

### **Food Quality**

Food quality is determined by appearance, size, shape, color, gloss and consistency, texture, and taste (Kisang, 2009). Restaurant experience depends greatly on the quality of the food (Sulek and Hensly, 2004). According to Bujisic et al. (2014) at both premium and quick-service restaurants, food quality, customer behavioral intentions, and word-of-mouth. Food quality has been viewed as the primacy criterion for guests to evaluate restaurant's performance and as the most significant aspect of restaurants (Ramanathan, 2015). Customer satisfaction is greatly influenced by food quality as well.

Shaharudin, Mansor, and Elias (2011) assert that food quality is increasingly important in determining how a consumer feels. Consumers today are well aware of the problems with food quality. In order to serve the demands and wants of their customers, all parties involved in the food industry should develop this competence, according to Whitehall et al (2006). Successfully presenting a visually beautiful meal can raise customer perceptions of quality and create a favourable impression in terms of how customers feel and behave when eating the food. (Shaharudin et.al, 2011).

### **Service quality**

The total rating of a product or service that is dependent on the customer's first impressions of the restaurant has been termed as service quality (Hooper et al, 2013). Based on the Brady and Robertson (2001) claim that staff communicate with customers through their attentiveness, assurance and empathy.

Customers in the restaurant business assess the quality of the cuisine as well as the service they experienced during their meal (Kivela et al, 2000). According to Cronin and Taylor (1994) service quality significantly influences behavioral intentions. The most important factors that influence the caliber of restaurant service must be identified specifically for this study (Tripathi and Dave, 2016). Due to the fierce rivalry in the food service sector, restaurant owners who are able to deliver exceptional service to their patrons will have a significant edge over their competitors to keep patrons and to achieve survival and growth (Ryu and Han, 2010).

## **Restaurant environment**

The atmosphere of a restaurant has emerged as one of the elements luring new customers while retaining existing ones. According to Han and Ryu (2009) when patrons eat in a restaurant, they may do it consciously before, during and after their meals. Previous research on the physical environment of the restaurant has emphasized the criteria of facility aesthetics, atmosphere, lighting, and table and pointed out that these components may affect customer satisfaction (Ryu & Jang, 2007).

The ambient aroma of a restaurant is important because it will be correlated with the emotional responses of customers, which can have an impact on how different levels of scent intensity affect shoppers' mood, behavior, and judgements in a retail space (Leeders Smidts and El Haji, 2016). As a result, the environment of a restaurant has a big impact on customers' happiness (Ryu and Jang 2008). In order to provide customers with a better experience while they are enjoying their dishes, it is crucial for the restaurateur to have a deeper awareness of what customers emphasize.

## RESEARCH HYPOTHESIS

In this study, the following three hypothesis were indicated based on the research objectives:

H1 : There is a significant relationship between service quality and consumer satisfaction among towards hipster food

H2 : There is a significant relationship between food quality and consumer satisfaction among youngsters towards hipster food

H3 : There is a significant relationship between restaurant environment and consumer satisfaction among youngsters towards hipster food.

## CONCEPTUAL FRAMEWORK

Figure 1 below has shown that the conceptual framework that was adapted from Sharee et al (2018) displays the independent variables (iv) and dependent variable (dv) of this research. The figure shows the relationship between service quality, food quality and restaurant environment influence customer satisfaction towards hipster food.

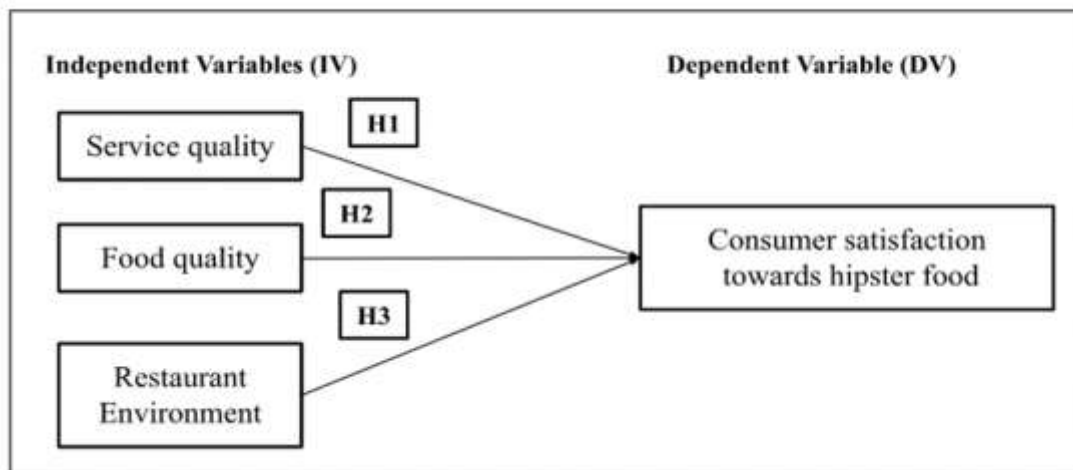

*Conceptual Framework adapted by Sharee et al., 2018.*

## **METHODOLOGY**

### **Research Design**

The term "research design" refers to the comprehensive method used to conduct research and describes a clear and logical strategy for addressing a predetermined research question through the collection, interpretation, analysis, and presentation of data. Descriptive studies are emphasized in this study. Data on perceived customer satisfaction among youngsters towards Hipster Food around Kota Bharu, as well as service quality, food quality, and restaurant environment have been collected through quantitative research in this study. Quantitative research is the process of collecting and evaluating numerical data. Patterns and averages can be found, predictions made, connections between variables verified, and results extended to larger groups. This is so that continuous and distinct numerical data can be generated using quantitative research techniques.

### **Data Collection**

Data collecting is a technique for compiling and analyzing data from multiple sources to obtain thorough and accurate data. Answering pertinent questions, assessing findings, and speculating about possibilities and current trends are all made possible by data collection for people or organizations. Youngsters, locals or hipster food enthusiasts in Kota Bharu, Kelantan, between the ages of 18 and 30 will be asked to complete questionnaires that will be conducted and distributed online by researchers utilizing the "google form" technique.

### **Sampling**

The sampling method was a statistical strategy in which a selection of observations was chosen from a broader population. Sample analysis and knowledge of its qualities or explanation would simplify the properties or characteristics of the population's rudiment for researchers. Due to the existing situation, a non-probability sampling technique called convenience sampling was chosen for this investigation. The questionnaire was created with Google Forms and distributed over social media platforms such as WhatsApp, Instagram and Twitter. Researchers could increase the number of respondents by using social media and google forms.

## Data Analysis

A statistical tool, often known as the computer programmer Statistical Package for Social Science (SPSS), version 27 is used to analyze the data. The researcher can choose the most appropriate statistical method with the aid of the SPSS programmer. The statistics generated by SPSS include good percentage and cumulative percentage.

## FINDINGS

### Result of Frequency Analysis

**Table 1**

Characteristics	Frequency	Percentage (%)
<b>Gender:</b>		
Male	117	46.1
Female	207	53.9
<b>Age:</b>		
Below 18	44	11.5
19 - 24	161	41.9
25 - 29	112	29.2
30 above	67	17.4
<b>Marital Status:</b>		
Single	246	64.1
Married	138	35.9
<b>Education Level:</b>		
Non-Formal Education	4	1.0
High School	86	22.4
Collage	81	21.1
University	200	52.1
Doctorate	13	3.4
<b>Source of Income:</b>		
Pocket Money	133	34.6

Spare-Time Job	89	23.2
Saving	69	18.0
Scholarship	78	20.3
Other	15	3.9
<b>Have visited a hipster food before this:</b>		
Yes	318	82.8
No	66	17.2
<b>I have been visited hipster food:</b>		
Less than 1 month ago	104	27.1
Less than 2 months ago	92	24.0
Less than 5 months ago	74	19.3
More than 5 months ago	56	14.6
Never visited	58	15.1
<b>I like take pictures of the food and design of the shop:</b>		
Yes	262	68.2
No	122	31.8

---

*Elaboration: The characteristics of respondents are gender, age, marital status, education level, source of income and other screening questions.*

Table 1 of frequency analysis shows the 384 respondents' genders. Male respondents made up (177 respondents with 46.1%) of the total respondents, while female respondents made up (207 respondents with 53.9 %). Next, according to age, people under the age of 18 (44 respondents with 11.5% ), respondents aged 19 to 24 years, (161 respondents with 16.1%) , while respondents aged 25 years to 29 years are (112 respondents with 29.2%) and finally, 30 and above are only ( 67 respondents with 17.4%). For marital status, the majority of the number of respondents that we got consisted of single status with a percentage of 64.1 percent (247 respondents) and for marital status, 35.9 percent with (138 respondents). Respondents with different levels of education, University education level is the highest number of respondents which is (200 respondents) with 52.1 percent. followed by high school which has respondents as many as (86 respondents) equal to 22.4 percent. The level of education for college is as many as 81 respondents with 21.1 percent.

The respondents for doctorate are as many as 13 respondents only. The very low level of education is no formal education which is as many as 4 respondents with 1.0 percent. Then, the percentages respondents by source of income are pocket money with 34.6 percent (133 respondents), spare-time job of 23.2 percent (89 respondents), scholarship as much as 20.3 percent (78 respondents), saving is as much as 18.0 percent (69 respondents) and lastly, other sources of income as much as 3.9 percent with (15 respondents). For example, salaries and PTPTN.

In addition, the screening question shows that most young people have been to hipster cafes, according to 82.8 percent (318 respondents) and only 17.2 percent (66 respondents) of young people had never been to a hipster cafe. The highest frequency of youngster's coming to Hipster Cafe is less than 1 month ago by 27.1 percent (104 respondents) followed by less than 2 months ago by 24.0 percent (92 respondents). Next, less than 5 months ago as much as 19.3 percent (74 respondents). The frequency of youngster's coming to Hipster Cafe, more than 5 months ago is as much as 14.6 percent (56 respondents) and lastly the frequency of youngster's coming to Hipster Cafe is never visited by 15.1 percent (58 respondents). Lastly, the majority of young people who like taking pictures and designs at Hipster Cafe are 68.2 percent (262 respondents) while 31.8 percent (122 respondents) who don't enjoy taking photos and designs when it comes to Hipster Cafe.



## Result of Descriptive Analysis

Table 2

Variable	Items	Mean Score	Standard Deviation
<b>Service</b>	Hipster café provides good service.	4.31	0.682
<b>Quality</b>	I think hipster café workers usually provide a friendly customer service that suits my preference.	4.24	0.714
	I prefer hipster café due to decent offers such as free WIFI, good music and air conditioning.	4.31	0.729
	I am willing to spend my time in a hipster café even though the price offered is expensive as it is reasonable with my expectations.	4.22	0.864
	The hipster café provides the service on time.	4.25	0.757
<b>Food</b>	The hipster café has a variety of menu items.	4.39	0.695
<b>Quality</b>	The freshness of food in hipster café is good.	4.28	
	The food presentation in the hipster café is attractive.	4.35	0.664
	I think the food provided is sufficient and filling.	4.30	0.748
	Food is served at the appropriate temperature in a hipster café.	4.30	0.717
<b>Restaurant Environment</b>	The facility layout in the hipster café allows me to move around easily.	4.40	0.719
	The interior design hipster café is visually appealing.	4.25	0.736
	Colors used in hipster café create a pleasant atmosphere.	4.32	0.707
	Lighting in hipster café creates comfortable atmosphere.	4.45	0.706
	Background music in the hipster café is pleasing.	4.40	0.666
<b>Youngster's Satisfaction Towards</b>	The night time service rendered by the café employees is respectful.	4.35	0.711
	The service provider, the staff is friendly and very polite.	4.33	0.656

<b>Hipster</b>	I'm tempted by some of my favorite dishes.	4.38	0.663
<b>Food</b>	I am satisfied with the quality of the taste of hipster food.	4.37	0.685
	The price listed each meal are very cheap and satisfying.	4.29	0.773

---

*Elaboration: The descriptive analysis of respondents are service quality, food quality, restaurant environment and the youngsters satisfaction towards hipster food.*

Table 2 shows the descriptive analysis of the influence of youngster's satisfaction towards hipster food in Kota Bharu, Kelantan. The highest mean of 4.31 for two items of service quality SQ1 and SQ3 on the statement "Hipster café provides good service" with "I prefer hipster café due to decent offers" has strongly agreed as to its agreement level. Otherwise, the lowest mean with 4.22 was for item SQ4 on the statement "I am willing to spend my time in a hipster café even though the price offered is expensive as it is reasonable with my expectations". The mean values for the other two items for SQ2 "I think hipster café workers usually provide a friendly customer service that suits my preference" and SQ5 "The hipster café provides the service on time" were 4.24 and 4.25 respectively and strongly agree as to its agreement level. While the average mean for service quality is 4.27, the respondents strongly agree that service quality plays a significant role for hipster cafes to attract more customers.

Beside the mean values for food quality, one of the independent variables. The highest mean value of 4.39 for the item FQ1, "The hipster café has a variety of menu items" has a strong agreement as its level of agreement followed by the item FQ3 "The food presentation in the hipster café is attractive" with the mean value of 4.35. Both item of FQ4 (I think the food provided is sufficient and filling) and FQ5 (Food is served at the appropriate temperature in a hipster café) shared same mean value 4.30 meanwhile the lowest mean value of 4.28 for the item FQ2 "The freshness of food in hipster café is good".

Next, the highest mean of restaurant environment value was 4.45 for the item of RE4 (Lighting in a hipster café creates a comfortable atmosphere) which strongly agree as the level of agreement. Followed by that, both items of RE1 (The facility layout in the hipster café allows me to move around easily) and RE5 (Background music in the hipster café is pleasing) shared the same mean value 4.40 with strong agreement as the level of agreement. The item of RE3 (Colors used in hipster café create a pleasant atmosphere) and item of RE2 (The interior design hipster

café is visually appealing) was 4.32 and 4.25 respectively, which strongly agree as the level of agreement.

Lastly, the highest mean of youngster’s satisfaction towards hipster food value was 4.38 for the item YS3 “I’m tempted by some of my favorite dishes” has strongly agree, the following was 4.37 and 4.35 which is the item of YS4 and YS1 “I am satisfied with the quality of the taste of hipster food” and “The night time service rendered by the café employees is respectful” has strongly agree respectively. Next, the mean value of 4.33 and 4.29 for the items of YS2 and YS5 “The service provider by the staff is friendly and very polite” and “The price listed on each meal are very cheap and satisfying” has strongly agree respectively.

### Result of Reliability Analysis

**Table 3**

Variable	Number of Items	Cronbach’s Alpha
Food Quality	5	0.837
Service Quality	5	0.834
Restaurant Environment	5	0.830
The influence youngster satisfaction towards hipster food	5	0.800

*Elaboration: The influence of youngster satisfaction is lower than restaurant environment, service quality and the highest is food quality according to Cronbach Alpha.*

The result of the reliability analysis by croncbach’s alpha, there are a total of three independent variables and the first one is food quality. This variable had a total of 5 items under it with Cronbach's alpha value of 0.837 with the reliability level of excellent (> 0.80). The second independent variable is service quality with 5 items used to test its reliability and validity. The Cronbach's alpha value for this variable is 0.834. This value falls under the reliability level of excellent (>0.80). The third independent variable used in this study is the restaurant environment with 5 items to test and Cronbach's alpha value is 0.830. This value is under the reliability level of excellent (>0.80).

## Result of Pearson Correlation Analysis

**Table 4**

Pearson's Correlation between service quality, food quality and restaurant environment for youngster satisfaction towards hipster food.

---

<b>Hypothesis</b>	<b>P-Value</b>	<b>Result</b> (Supported/Not Supported)
<b>H1:</b> There is a poor positive relationship between service quality and consumer satisfaction among youngsters towards hipster food.	0.477	H1 is supported
<b>H2:</b> There is a poor positive relationship between food quality and consumer satisfaction among youngsters towards hipster food.	0.467	H2 is supported
<b>H3:</b> There is a poor positive relationship between restaurant environment and consumer satisfaction among youngsters towards hipster food.	0.513	H3 is supported

---

*Elaboration: All three hypotheses are supported for the P-Value.*

The table shows the Pearson correlation coefficient, significant value, and number of respondents (384). The P-value was 0.001, which was less than a significant level of 0.01. The correlation coefficient of 0.477 suggested a poor positive correlation between service quality and consumer satisfaction toward hipster food for hypothesis 1. Next for hypothesis 2, the correlation coefficient of 0.467 suggested a poor positive correlation between food quality and consumer satisfaction toward hipster food and 0.513 of hypothesis 3 suggested a poor positive correlation between restaurant environment and consumer satisfaction toward hipster food.

## **DISCUSSION AND RECOMMENDATION**

The study's primary shortcoming is the large sample size of 384 respondents, particularly among young Kota Bharu hipster food-influenced individuals. Most participants ignored the survey or watched it, and some felt it was unimportant or helpful. The questionnaire was sent via social media, making it difficult for respondents to respond privately.

The study's limitations in independent variables, including environment, food, and service quality, hinder its effectiveness. The study's drawback is limited data collection due to the lack of knowledge about hipster food in Kota Bharu, Kelantan and the lack of information in previous publications. This situation makes it difficult to speak with young people who have a significant influence over hipster cuisine.

The study's limitations in getting data on hipster food in Kota Bharu, Kelantan due to limited knowledge and lack of information in previous publications. This makes it difficult to speak with young people who influence hipster cuisine.

This study used a quantitative approach to gather information from respondents, using a google form as a data collecting medium. However, face-to-face interviews can also be used to strengthen the result of the study. Google form allows respondents to answer questions with an unsure understanding of the question, while face-to-face interviews can help to enhance the respondents if they have any questions.

The researcher suggests that future studies should enhance data collection by giving respondents more time to complete a survey, making it easier for the researcher to complete the questionnaire and discover more responders. This will enable the researcher to obtain more accurate data.

Besides, the researchers suggest that the future researchers should conduct a study using observation surveys, which is the act of recognizing and noting facts or occurrences without asking questions. This approach can be used to study customers' motivation towards hipster food without the need for a large number of respondents.

## CONCLUSION

The results of this study showed a relationship between customer satisfaction with hipster cuisine and the quality of the food, the quality of the service, and the atmosphere of the restaurant. Food quality was the most effective element influencing consumers' satisfaction with hipster food. This study may be applied to the food and beverage business in the tourist sector to improve the quality of its goods and as a reference for future research.

Furthermore, it can be inferred from the data from chapter 4's statistical package for the social sciences (spss) version 26 that there is a strong correlation between the quality of the food, the standard of the service, and the atmosphere of the restaurant—all of which have an effect on young people's satisfaction with hipster food. The information gathered from this study will enable related businesses and industries to generate income and profits, which will contribute to the expansion of the Malaysian economy.

## REFERENCES

- Akter, M., Sadekin, M. N., & Patwary, A. K. (2020). An Empirical Study on Students' Satisfaction from Mawlana Bhashani Science & Technology University, Bangladesh. *Review of Economics and Development Studies*, 6(2), 363-379.
- Al Mahmud, S. R. (2020). The effectiveness of Facebook advertisements on purchase intention of customers in Malaysia. *South Asian Journal of Social Sciences and Humanities*, 1(1), 97-104.
- Alom, S., Patwary, A. K., & Khan, M. M. H. (2019). Factors affecting the turnover intention of Bangladeshi migrants in the United Arab Emirates: An empirical study on the hotel industry. *International Journal of Innovation, Creativity and Change*, 8(3), 344-360.
- Brady, M. K., & Robertson, C. J. (2001). Searching for a consensus on the antecedent role of Service Quality and satisfaction: An exploratory cross-national study. *Journal of Business Research*, 51(1), 53–60.
- Fengmin, Z., Baijun, W., Jiangtao, B., Li, L., & Patwary, A. K. (2022). Investigating revisit intention of medical tourists in China through nutritional knowledge, perceived medical quality, and trust in the physiologist: A recommendation on health tourism policy measures. *Frontiers in Public Health*, 10, 893497.
- Hazbar, A. M. H., Alem Mohammed, A., & Karim, A. K. A. (2019). An Empirical Study of Factors Influencing hotel customers' online booking Intention. *مجلة العلوم التربوية و الدراسات الإنسانية*, 5(5), 1-17.

- Hooper, D., Coughlan, J., & R. Mullen, M. (2013). The servicescape as an antecedent to service quality and behavioral intentions. *Journal of Services Marketing*, 27(4), 271–280.
- Kivela, J., Inbakaran, R., & Reece, J. (2000). Consumer research in the restaurant environment. Analysis, findings and conclusions. *International Journal of Contemporary Hospitality Management*, 12 (1), 13 – 30.
- Leenders, M. A. A. M., Smidts, A., & Haji, A. E. (2019). Ambient scent as a mood inducer in supermarkets: The role of scent intensity and time-pressure of shoppers. *Journal of Retailing and Consumer Services*, 48, 270–280.
- Li, L., Ragavan, N. A., Patwary, A. K., & Baijun, W. (2022). Measuring patients' satisfaction toward health tourism in Malaysia through hospital environment, nutritional advice, and perceived value: A study on Chinese exchange students. *Frontiers in public health*, 10, 893439.
- Li, L., Wu, B., & Patwary, A. K. (2022). How marine tourism promote financial development in sustainable economy: new evidences from South Asia and implications to future tourism students. *Environmental Science and Pollution Research*, 29, 1155-1172.
- Li, L., Wu, B., & Patwary, A. K. (2022). The psychosocial factors affecting chinese Outbound Exchange and mobility students' academic performance during COVID-19. *Frontiers in psychology*, 13, 872516.
- Mohd. Zahari, M. S., Kamaruddin, M. S. Y., Muhammad, R., & Kutut, M. Z. (2011). Modernization, Malay matrimonial foodways and the community social bonding. *International Journal of Human and Social Sciences*, 6(3), 10
- Patwary, A. K., Roy, B., Hoque, R., & Khandakar, M. S. A. (2019). Process of developing a community based tourism and identifying its economic and social impacts: An Empirical study on Cox's Bazar, Bangladesh. *Pakistan Journal of Humanities and Social Sciences*, 7(1), 1-13.
- Platania, M., & Privitera, D. (2003). Typical products and consumer preference: The Soppresata case. *British Food Journal*, 108(5), 385-395.
- Ramanathan, M., Chandra, P., & Deshpande, S. D. (2015). Studies on millet idli batter and its quality evaluation.
- Ryu, K., & Jang, S. (2008). DINESCAPE: A scale for customers' perception of dining environments. *Journal of Foodservice Business Research*, 11(1), 2-22.
- Ryu, K., & Jang, S. S. (2007). The effect of environmental perceptions on behavioral intentions through emotions: The case of upscale restaurants. *Journal of Hospitality & Tourism Research*, 31(1), 56-72.
- Shaharudin, M. R., Mansor, S., & Elias, S. J. (2011). Food quality attributes among Malaysia's fast-food customers, 2., 198 – 208.

- Sharee, Asyraf, and Nur Shahrulliza Muhammad. "Young Adults' Satisfaction towards Hipster Cafes: The Brewing Factors." *Advances in Business Research International Journal (ABRIJ)* 4.2 (2018): 41-52.
- Sulek, J. M., & Hensley, R. L. (2004). The relative importance of food, atmosphere, and fairness of wait: The case of a full-service restaurant. *The Cornell Hotel and Restaurant Administration Quarterly*, 45(3), 235–247.
- Sumethokula, P., Patwary, A. K., Srinuanpanc, B., Srinuanpand, C., Suwandee, P., Thammathikulf, A., & Phanong, W. (2020). The potential of new tour repackaging for creative tourism among entrepreneurs in Nakhon Si Thammarat. *International Journal of Innovation, Creativity and Change*, 13(10), 1752-1771.
- Tripathi, G., & Dave, K. (2016). Assessing the impact of restaurant service quality dimensions on customer satisfaction and behavioural intentions. *Journal of Services Research*, 16(1), 13.
- Wu, B., Liu, S., Wang, J., Tahir, S., & Patwary, A. K. (2021). Assessing the mechanism of energy efficiency and energy poverty alleviation based on environmental regulation policy measures. *Environmental Science and Pollution Research*, 28, 40858-40870.
- Wu, B., Zhai, B., Mu, H., Peng, X., Wang, C., & Patwary, A. K. (2021). Evaluating an economic application of renewable generated hydrogen: A way forward for green economic performance and policy measures. *Environmental Science and Pollution Research*, 1-15.



# **Factors Influencing Visitors Motivations in Attending Food Festival in Malaysia**

**Nurul Ain Nazihah Binti Kamaruddin, Nurul Ain Syafiqah Bt Mat Said, Nurul Akmal Hayati Binti Abu Bakar, Nurul Asyira Binti Rustam &\*Nurul Fardila Binti Abd Razak**

**Faculty of Hospitality, Tourism and Wellness, Universiti Malaysia Kelantan**

**Corresponding email: [fardila.ar@umk.edu.my](mailto:fardila.ar@umk.edu.my)**

---

## **ABSTRACT**

This study discusses the factors influencing visitors motivations in attending food festival in Malaysia. Therefore, this study empirically also aims to identify perceived value, service quality, food and can identify visitors motivations in attending food festival. The research objectives is to determine the relationship between perceive value, service quality, food and visitors motivations in attending food festival in Malaysia. In addition, the method used to complete this report is through questionnaires. Google forms were distributed to 384 respondents. Using SPSS, the data from 384 respondents were analysed using descriptive, frequency, and inferential statistics. Results demonstrate a significant correlation between perceived value, service quality and food. The findings demonstrate that foods, with a mean score of 4.08, have a significant association with visitors motivations in attending food festival, but service quality, with a mean score of 4.00, has the least significant relationship with visitors motivations in attending food festival. Finally, implications and recommendations for more research in accordance with the findings were offered.

**Keywords: food festival, visitors motivations, perceived value, service quality & food**

---

## **INTRODUCTION**

Typically, these events draw a sizable number of food-related exhibitors who are engaged in the creation and marketing of distinctive, frequently traditional products. Festivals give exhibitors the chance to market their goods, impart knowledge, and trade stories (De & Varley 2018). Some vendors sell their goods exclusively (or even exclusively) at the food festival. It's important to note that vendors at food festivals frequently represent tiny local businesses, such as tiny rural agribusinesses, that support widely acknowledged local development (Folado et.al, 2019)

Prioritise the experiential and environmental aspects of food festivals. However, few studies have examined the correlation between food festival attendance and food-centric tourist behaviour. The majority of research on food festivals has concentrated on event-related factors and outcomes such as service quality, customer's happiness, and loyalty intentions (Lee, Sung, Suh, & Zhao, 2017). Furthermore, recent study focuses on the quality and worth of festivals, which will improve the perception of destinations and strengthen travellers' commitment to certain destinations.

This study consists of three objectives:

1. To determine the relationship between perceived value and visitors motivations in attending food festival in Malaysia

2. To determine the relationship between service quality and visitors motivations in attending food festival in Malaysia
3. To determine the relationship between food and visitors motivations in attending food festival in Malaysia

## **Significance of the Study**

### **Consumers**

Future readers of this research paper will be able to learn more about the aspects of food festivals that draw tourists. In essence, food festivals can expose a lot of people to different countries and their culinary traditions. As a result, this study will demonstrate how well-liked the various delicacies present at the food festival are among the tourists. The qualities and properties of food that have evolved over time and with the rise in living standards in current contemporary era can also be shown to future consumers by this research report.

### **Industry of Tourism**

The tourism industry could benefit from a better understanding of the types of reasons why tourists opt for local fare by learning more about the factors influencing local food consumption. The travel industry should be able to better serve both domestic and international visitors as a result.

### **Researchers**

This study is significant for the tourism sector since local food intake has become one of the reasons why visitors go. This study will aid scholars in understanding what draws people to food festivals, what keeps them coming back, and how the local population generally feels about trying new types of food. Following that, this study will enable researchers to pinpoint significant visitor-influencing factors and previously unresearched reasons why people attend food festivals. The subject of this journal article might be useful to future scholars.

### **Food vendor**

This research paper can provide future sellers with information about the factors that attract buyers to food festivals.. Basically, food festivals can give vendors a chance to showcase the variety of cuisine styles and tastes from different nations. The qualities and properties of food have changed throughout time as a result of the advancement of living standards in the modern era, and this research article can help future vendors understand these changes.

## **LITERATURE REVIEW**

### **Perceived Value**

Perceived value, according to the definition, is the individual's appraisal of the difference between the benefits and the expenses. Four factors may be used to determine value: "Value is (1) cheap price, (2) having what one wants in a product, (3) the quality one obtains for the money one spends, and (4) what one receives in return for what one contributes. According to the equity theory, a consumer considers what is fair, acceptable, or warranted for the perceived cost of the service, which includes monetary payments as well as non monetary sacrifices such as time, energy, and stress borne by consumers (Akhoondnejad, 2016). Perceived value is a

crucial aspect in developing long-term client connections and achieving a competitive advantage. In the case of festivals, participants weigh the advantages they get against the sacrifice they make in terms of time, money, and effort (Akhoondnejad, 2016). However, if you're only interested in the food, these festivals are rarely worth the money or time (Dai serena, 2017) .

## **Service Quality**

Service quality is frequently the kind of customer perception throughout the purchasing process when the good or service being delivered is characterised as a gap model, which is a difference between the customer's view of the service and their expectations (Parasurama et.al, 1998). In addition, service quality measures how well the level of service provided fulfils consumers' expectations (Lewis & Boom, 1983). The degree of service quality that goes along with a company's offers may be a key element for differentiating between performing and non- performing business establishments, according to Eresia-Eke et.al, (2018). The contact between a client and components in the service organisations also produces service quality, according to Lethinen & Lethinen's, (1982). It could result in an emotional response that shows up as happiness or discontent with the goods or services bought (Woodruff. et al, 1983). In order to keep their consumers, internet meal delivery businesses need pay attention to the quality of their services. If the value of the services they receive is perceived to be significantly superior than what is anticipated from competitors, customers may continue to be loyal to a service provider (Zeithaml & Bitner, 1996). Customers frequently want deep, individualised ties with service providers and value the advantages of sustaining relationships (Zeithaml et.al, 1996). As a result, service clients are crucial to preserving clients' loyalty (Parasuraman et.al, 1991).

## **Food**

Based Sharina Osman & Norwani Nazari (2020), one of the reasons people now travel is for the food, which has a significant multiplier impact in tourist places. food has always been a major draw to any location and is frequently highlighted in marketing materials by numerous locations. This occurrence is one of the indications that food has to offer as a travel item.

Food consumption becomes a crucial component of tourism as it becomes an essential component of the tourist experience Hall & Mitchell (2000). For some people, food means different things. According to Ab Karim (2010), a destination's food reputation and the nature of its information sources have a significant role in influencing tourists' desire to visit that location. According to this perspective, Malaysia conjures up ideas of Malaysian cuisine and tourism. Although tourists are pleased with the food photos, there is certainly room for improvement. Additionally, they stated that eating contributes to overall pleasure, which will also impact their behavioural intentions.

## **Dependent Variable**

### **Visitors Motivations in Attending Food Festival**

Many authors have characterized motivation in many ways Inkson & Minnaert (2018). As the main cause and driving force underlying all human behavior, for example (IsoAloha, 1982) an awakening, guiding, and integrating physiological and psychological desire that awakens, directs, and integrates a person's conduct and activities (Pearce & Lee, 2005).

Their attitudes, perceptions, and motivations have a big impact on the decisions they make about their journey. In addition to more basic tourism-related motivations, research has been done to identify what motivates people to attend festivals.

The three factors that influence motivation are perceived value, food, and service quality. On the other hand, perceived value is essential for building strong relationships with customers and gaining a competitive advantage. When evaluating the value of a festival, attendees compare the benefits they receive with the time, money, and effort requirements (Akhoondnejad, 2016). Next, service quality, which is polygonally organized and emphasizes tangibles in addition to efficacy, responsiveness, assurance, and empathy. When the product or service being provided is categorised as a gap model, which is a discrepancy between the customer's perception of the service and their expectations (Parasuraman & Berry, 1998), service quality is frequently the type of client impression during the purchasing process. The last is location's food has a big impact on its reputation and desirability. Eating has become a significant part of tourism due to how crucial it is to the overall tourist experience (Mitchell & Hall, 2000).

### **Research Hypothesis**

The hypothesis of this research is to determine if there are any correlations or relationships between dependent variables and independent variable:

H1: There is a strong correlation between perceived value and visitors motivations in attending food festival in Malaysia.

H2: There is a connection between service quality and visitors motivations in attending food festival in Malaysia.

H3: There is significant relationship between food and visitors motivations in attending food festival in Malaysia.

## Research Framework

For the purpose of investigating the connection between visitors motivations in attending food festivals in Malaysia, a research framework has been given. Then, the food, the perceived value, and the service quality influence the visitor's motivation in attending food festival in Malaysia, which was used to put the hypothesis to the test.

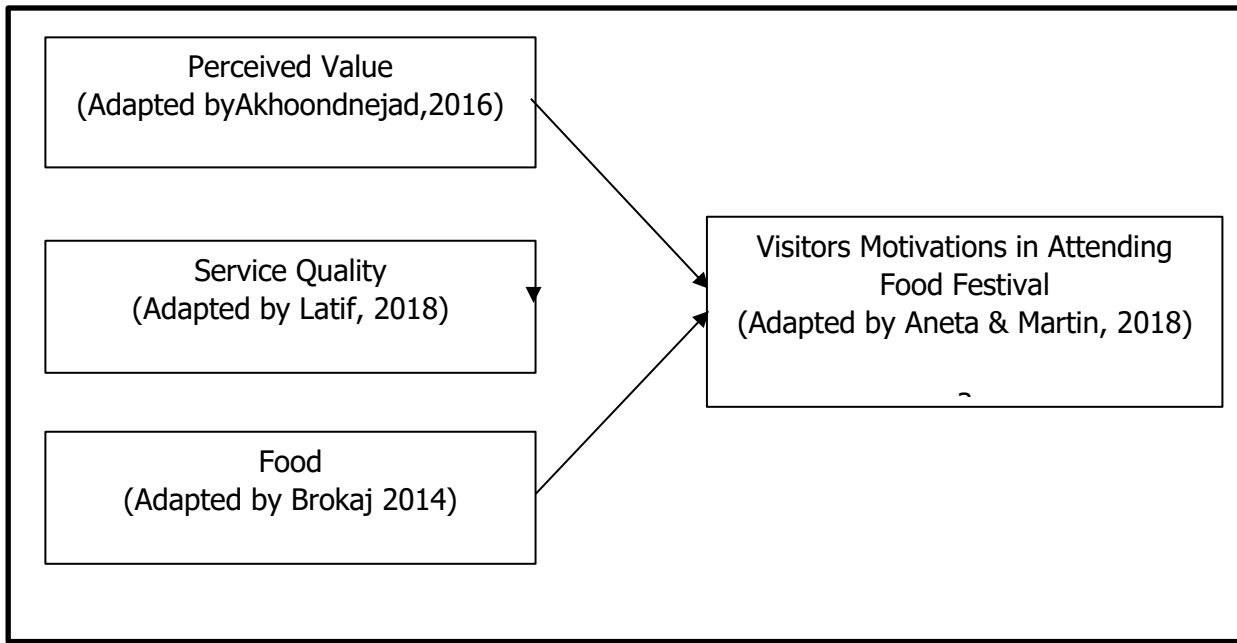

Figure 1: Conceptual Framework

## METHODOLOGY

### Research Design

In this quantitative study, 384 customers who attended a Malaysian food festival were given questionnaires. The people of Malaysia will serve as the subjects for this study. The questionnaire was split into three parts by the researcher: sections A, B, and C. The demographics of the respondents are presented in Section A. In Sections B and C on independent factors and dependent variables, five items using a five-point Likert scale ranging from 1 (Strongly Disagree), 2 (Disagree), 3 (Neutral), 4 (Agree), and 5 (Strongly Agree) were utilised. The purpose of the study design is to identify the variables that affect why people choose to attend the food festival and to ensure that the evidence derived from the data can address the issue under investigation. To understand perceived value, service quality, and food for food festivals in Malaysia, it is crucial to use a quantitative approach.

### Data Collection

Primary data is collected using suitable methods for current study challenges, while secondary data is obtained from other researchers. Data can be used for comparative research, replication, data reanalysis, research design, methodological advancement, learning, teaching, and describing current and historical traits. This study employs quantitative data gathering through surveys and questionnaires, utilizing mathematical computations for objective and trustworthy data. The data includes 384 participants, divided into sections A, B, and C, in both English and

Malay. This approach simplifies participant completion and enables researchers to compare and analyze collected data.

### Sampling

This research utilised a non-probability sampling method known as convenience sampling. Convenience sampling is the practise of collecting samples based on the availability of elements and their ease of acquisition. This sample was chosen because it occurred at the appropriate location and time. The benefit of convenience sampling is that it is quick and simple. Because the researcher can select respondents at random, he or she has the freedom to determine the sample, select it, and produce accurate data using this method. The survey is created with Google Forms and distributed via social media. Using Google Forms and social media, WhatsApp and Telegram researchers can attract more participants.

### Data Analysis

Data analysis involves organizing, describing, representing, evaluating, and interpreting data using statistics. SPSS, version 24, is used in this study to analyze data using descriptive analysis and correlation. It allows researchers to conduct intricate statistical analysis on large datasets, aiding in reliability analysis, descriptive analysis, and Pearson's correlation coefficient.

## FINDINGS

### Demographic Analysis

Table 1: Demographic Analysis

Characteristics	Frequency	Percentage(%)
<b>Gender:</b>		
Male	96	25.0
Female	288	75.0
<b>Age:</b>		
Below 18	41	10.7
18 - 23	240	62.5
24 - 29	58	15.1
30 above	45	11.7
<b>Marital Status:</b>		
Single	290	75.5
Married	68	17.7
Others	26	6.8
<b>Occupation:</b>		
Student	257	66.9

Employee	74	19.3
Unemployed	79	7.6
Others	29	6.3
<b>Do you familiar with food festival ?:</b>		
Yes	339	88.3
No	45	11.7
<b>Why do you choose to buy food at food festival?:</b>		
Reasonable price	91	23.4
Fast service	81	21.1
Many options	141	36.7
Others	72	18.8
<b>How many times do you visit food festival in a year:</b>		
Once a month	49	12.8
Once every 3 months	71	18.5
Once every 5 months	130	33.9
Others	134	34.9

---

Table 1 showing the summarize of demographic analysis totalling the male respondent was 96 respondents with the percentage 25.0% while the female respondent is 288 respondents with the percentage 75.0%. Meanwhile the highest range of the age respondent participating was 18 to 23 years old 240(62.5%) follow for the second highest was 24 to 29 years old 58 (15.1%) , third is range for 30 and above 45(11.7%) and the slightest range is below 18 years old 41(10.7%). Other than that, the majority of respondents marital status is single that consist of 290 respondents with the percentage 75.5% and the second highest is married respondent which is 68 respondents equal to 17.7% while the minor respondent who answering is other 26 respondent with 6.8%.

Next, the total number of students was 257 respondents and 66.9% for employed was 74 respondent and 19.3% followed by Unemployed 29 respondent with 7.6% and others 24 respondent and 6.3%. As for the screening question the respondent who is familiar with food festival was 339 respondent and 88.3% while 45 respondents equal to 11.7% were not familiar with food festival. Therefore, respondents who choose to buy food at a food festival found that it had many option was 141 respondent and 36.7% and as for the reasonable price was 90 respondent with 23.4% , fast service fall to third highest why visitor choose to buy at food festival which was 81 respondent and 21.1% and least was others with 72 respondent with the percentage of 18.8%.

Furthermore, the highest respondents visiting food festival was others where 134 respondent and 34.9% and for once for every 5-month respondent that visit food festival was 130 and 33.9% followed by once every 3-month 71 respondent and 28.5% followed by once a month 49 respondent and 12.8%.

## Descriptive Analysis

This study has analysed the mean and standard deviation for section B and C of the questionnaires.

### Result of Descriptive Analysis

**Table 2**

Table 2: Descriptive analysis

<b>Variable</b>	<b>Items</b>	<b>Mean Score</b>	<b>Standard Deviation</b>
<b>Perceived Value</b>	The prices at the food festival are reasonable	3.77	1.170
	I believe the food at the food festival is good quality	3.55	0.803
	I acknowledge that various foods that I want to buy are available at food festivals	3.99	0.978
	I believe the vendors at the food fair are keeping clean	3.83	1.002
	Food festival provides a lot of convenience	3.85	1.037
<b>Service Quality</b>	The sellers at the food festival have friendly treatment for visitors	3.94	0.972
	The seller is aware of food hygiene when serving, wearing gloves, mesh, and apron	3.80	1.027
	I think the food at the food festival are served quickly	4.01	0.930
	The seller makes a detailed menu of each dish available or visible to the visitors	4.02	0.927



	I believe the seller at the food festival takes the order by following the correct order to the visitors	4.01	0.928
<b>Food</b>	I believe food involvement play a crucial part in food festival	4.07	0.950
	foods that serve in food festival come from different culture	4.11	0.928
	Enjoying food in food festival giving a pleasurable experience	4.10	0.917
	visitor satisfaction will be accomplished with the food taste in food festival	4.07	0.948
	Going to food festival allow to have a good meal and beverage	4.16	0.885
<b>Visitors motivations in attending food festival</b>	Going to food festival can satisfy my curiosity about viral food	4.31	0.959
	Going to food festival can support the local community	4.33	0.889
	I go to the food festival to escape daily routine	3.84	1.082
	I think going to food festival can spend time with family or partner	4.00	0.930
	I go to food festival to gain new experiences	3.92	1.031

The mean and standard deviation analyses on the independent variable, perceived value. The maximum mean value was 3.99, where respondents thought that acknowledge that various foods that want to buy are available at food festival.

The mean and standard deviation analyses of respondents on the independent variable, service quality where it had the highest mean score of 4.02, indicating the seller makes a detailed menu of each dish available or visible to the visitors.

The mean and standard deviation analysis of respondents on the independent variable, food, where item 1 had the highest mean value of 4.16, indicating that respondents consented to going to food festival allow to have a good meal and beverage.

The mean and standard deviation analysis of respondents on the dependent variable, is Visitor motivation in attending food festival service where the item 5 shows the highest mean value of 4.33, indicating that respondents Going to food festival can support the local community.

### Reliability Analysis

It was decided that reliability analysis would be utilised to assess the questionnaires' dependability. It was also utilised to gauge how steady and reliable the produced assessment tools were. When measuring internal consistency and reliability scales, Cronbach's Alpha analysis was used to determine the instrument's reliability based on the data. The table below displays the size of the Rules of Thumb Cronbach's Alpha coefficient, according to George & Mallery (2016).

Table 3 : Cronbach's Alpha Coefficient Range. Sources: Adopted from George & Mallery (2016).

Cronbach's Alpha Range	Level of Reliability
$\alpha > 0.9$	Excellent
$\alpha > 0.8$	Good
$\alpha > 0.7$	Acceptable
$\alpha > 0.6$	Questionable
$\alpha > 0.5$	Poor
$\alpha < 0.4$	Unacceptable

The range of Cronbach's Alpha coefficient values was displayed in table 3. Internal consistency is deemed excellent when the value is greater than or equal to 0.90, with a maximum value of 1. Moreover, a Cronbach's Alpha value of less than 0.4 is deemed unacceptable.

Table 4 : Result of Reliability Coefficient Alpha for the Independent Variable and Dependent Variable

Variable	Number of items	Reliability Cronbach's Alpha	Level of reliability
Perceived value	5	0.913	Excellent
Service quality	5	0.940	Excellent
Food	5	0.959	Excellent
Visitors motivation in attending food festival	5	0.906	Excellent

Table 4 displays the results of the reliability analysis using Cronbach's Alpha for each independent and dependent variable. The first item, perceived value, had a Cronbach's Alpha score of 0.913 and an outstanding reliability level ( $> 0.9$ ) out of a total of five. The following independent variable is service quality, which consists of five elements. Cronbach's Alpha is 0.940 for this variable. This rating corresponds to an extremely high degree of dependability (0.9). The dependent variable, which measured visitors' motivations for attending a food festival, contained five items. This variable's Cronbach's Alpha score is 0.906, which is below the level of excellent reliability. The Cronbach's Alpha for the three-food test utilised in this study is 0.959. This is below what we consider to be an excellent level of dependability (0.9).

## Pearson Correlation Analysis

Pearson's correlation analysis was one of the most important analyses that looked at the linear relationship between the two variables. The purpose of this study was to examine if there were any links between the independent factors (perceived value, service quality and food) and the dependent variable (visitors motivations in attending food festival). If the relationship is significant, the researchers must decide the acceptable level of association strength.

## Result of Pearson Correlation Analysis

Table 3: Pearson Correlation Analysis

Hypothesis	P-Value	Result (Supported/Not Supported)
<b>H<sub>1</sub>: There is strong correlation between perceived value and visitors motivations in attending food festival in Malaysia</b>	0.583	H <sub>1</sub> is supported.
<b>H<sub>2</sub>: There is a connection between service quality and visitors motivations in attending food festival in Malaysia</b>	0.664	H <sub>2</sub> is supported.
<b>H<sub>3</sub>: There is significant relationship between food and visitors motivations in attending food festival in Malaysia</b>	0.722	H <sub>3</sub> is supported

Table 3 displays the results of the Pearson Correlation Analysis. For the statistically significant value, the total number of respondents (384), and the perceived value. The p-value was 0.000, which was less than the threshold for statistical significance of 0.01. The correlation between perceived value and visitors motivations to attend a food festival was moderately positive, with a value of 0.583.

In addition, for the service quality level, the significance, and the total (384) respondents. The p-value was 0.000, which was less than the threshold for statistical significance of 0.01. The correlation coefficient of 0.664 indicates a moderately positive relationship between service quality provided and visitors motivations to attend a food festival.

Next, the food's significant value and total of 384 are presented. The p-value was 0.000, which was less than the threshold for statistical significance of 0.01. The correlation between food and visitors motivations to attend a food festival was moderately positive, with a value of 0.722.

## **DISCUSSION & RECOMMENDATION**

The study analysing the relationship between perceived value, service quality, food and visitors motivations in attending food festival. The purpose of this study is to determine the relationship between perceived value, service quality, food and visitors motivations in attending food festival.

Recommendations are ideas for upcoming research projects that address the shortcomings of the current study. The results of this study could therefore be applied to future research to enhance data collection techniques. Formal interviews are highly recommended. In a structured interview, each respondent is asked the same questions in the same order from a well-crafted, pre-planned list of questions. Due to the fact that a primary focus of quantitative research is the statistical analysis of numerical data collected through general survey research techniques such as questionnaires or structured interviews, this is the case. While questionnaires are useful for acquiring data, face-to-face interviews give the researcher clear, accurate information.

To confirm that the data obtained is accurate and legitimate, it is also advised to choose local communities close to the research area. The information provided by the community as a respondent may not be accurate because of limited exposure to the particular research area selected.

## **CONCLUSION**

In conclusion, the researcher clarifies whether all the research findings implemented can address the chapter's research objectives. This study aims to determine the relationship between the independent and dependent variables. The three independent variables are perceived value, service quality, and food, while the dependent variable is visitors motivation in attending food festival Utilising Pearson's Correlation Analysis, the relationship between the independent and dependent variables was determined. This demonstrates the effect of the independent variable on the dependent variable. Three independent variables, namely perceived value, service quality, and food, have a significant relationship with visitors motivations in attending food festivals in Malaysia, according to the findings of researchers. A total of 384 respondents were selected from the country on the east cost Malaysian states for this study. This study concludes that there is a positive correlation between the independent variables perceived value, service quality, and food. The data reveals the three factors influencing visitors motivations in attending food festivals in Malaysia.

## **REFERENCE**

- Ab Karim, S., & Chi, C. G.-Q. (2010). Culinary tourism as a destination attraction: An empirical examination of destinations' food image. *Journal of Hospitality Marketing & Management*, 19(6), 531-555. Parasuraman, A.; Zeithaml, V.A.; Berry, L.L. Communication and Control Processes in the Delivery of Service Quality. *J. Mark.* 1988, 52, 35-48.
- Akhoondnejad, A. (2016). Tourist loyalty to a local cultural event: The case of turkmen handicrafts festival. *Tourism Management*, 52, 468-477.

- Akter, M., Sadekin, M. N., & Patwary, A. K. (2020). An Empirical Study on Students' Satisfaction from Mawlana Bhashani Science & Technology University, Bangladesh. *Review of Economics and Development Studies*, 6(2), 363-379.
- Alom, S., Patwary, A. K., & Khan, M. M. H. (2019). Factors affecting the turnover intention of Bangladeshi migrants in the United Arab Emirates: An empirical study on the hotel industry. *International Journal of Innovation, Creativity and Change*, 8(3), 344-360.
- De Jong, A.; Varley, P. Food tourism and events as tools for social sustainability? *J. Place Manag. Dev.* 2018, 11, 277–295.
- Fengmin, Z., Baijun, W., Jiangtao, B., Li, L., & Patwary, A. K. (2022). Investigating revisit intention of medical tourists in China through nutritional knowledge, perceived medical quality, and trust in the physiologist: A recommendation on health tourism policy measures. *Frontiers in Public Health*, 10, 893497.
- Folgado-Fernández, J.A.; Di-Clemente, E.; Hernández-Mogollón, J.M. Food Festivals and the Development of Sustainable Destinations. The Case of the Cheese Fair in Trujillo (Spain). *Sustainability* 2019, 11, 2922.
- Hall, C. M., & Mitchell, R. (2000). We are what we eat: The host community perspective. *Journal of Sustainable Food, Tourism, and Globalization. Tourism, Culture, & Able Tourism*, 14(5), 425–448. *Communication*, 2, 29–37.
- Hazbar, A. M. H., Alem Mohammed, A., & Karim, A. K. A. (2019). An Empirical Study of Factors Influencing hotel customers' online booking Intention. *مجلة العلوم التربوية و الدراسات الإنسانية*, (5), 1-17.
- Hsu, F. C., Agyeiwaah, E., Lynn, I., & Chen, L. (2021). Examining food festival attendees' existential authenticity and experiential value on affective factors and loyalty: An application of stimulus-organism-response paradigm. *Journal of Hospitality and Tourism Management*, 48, 264-274.
- Iso-Ahola, S.E. (1982). Toward a social psychological theory of tourism motivation: A rejoinder. *Annals of Tourism Research*, 9(2), 256-262. doi:10.1016/0160-7383(82)90049-4
- Krajíčková, A., & Šauer, M. (2018). Differences in motivation of food festivals visitors—A view from the Czech Republic. *Geographica Pannonica*, 22(3).
- Latif, K. F. (2017). The development and validation of stakeholder-based scale for Measuring University Social Responsibility (USR). *Social Indicators Research*, 140(2), 511–547.
- Lee, W., Sung, H., Suh, E., & Zhao, J. (2017). The effects of festival attendees' experiential values and satisfaction on re-visit intention to the destination: The case of a food and wine festival. *International Journal of Contemporary Hospitality Management*, 29(3), 1005-1027.
- Li, L., Ragavan, N. A., Patwary, A. K., & Baijun, W. (2022). Measuring patients' satisfaction toward health tourism in Malaysia through hospital environment, nutritional advice, and perceived value: A study on Chinese exchange students. *Frontiers in public health*, 10, 893439.
- Li, L., Wu, B., & Patwary, A. K. (2022). How marine tourism promote financial development in sustainable economy: new evidences from South Asia and implications to future tourism students. *Environmental Science and Pollution Research*, 29, 1155-1172.

- Li, L., Wu, B., & Patwary, A. K. (2022). The psychosocial factors affecting chinese Outbound Exchange and mobility students' academic performance during COVID-19. *Frontiers in psychology*, 13, 872516.
- Osman, S., & Nazari, N. (2020). Reviewing Food as a Tourism Product. *International Journal of Innovation, Creativity and Change*, 10(8).
- Patwary, A. K., Roy, B., Hoque, R., & Khandakar, M. S. A. (2019). Process of developing a community based tourism and identifying its economic and social impacts: An Empirical study on Cox's Bazar, Bangladesh. *Pakistan Journal of Humanities and Social Sciences*, 7(1), 1-13.
- Pearce, P. L. & Lee, U. (2005). Developing the Career Approach to Tourist motivation. *Journal of Travel Research*, 43(3), 226-237. doi: 10.1177/0047287504272020.
- Sumethokula, P., Patwary, A. K., Srinuanpanc, B., Srinuanpand, C., Suwandeee, P., Thammathikulf, A., & Phanong, W. (2020). The potential of new tour repackaging for creative tourism among entrepreneurs in Nakhon Si Thammarat. *International Journal of Innovation, Creativity and Change*, 13(10), 1752-1771.
- Wu, B., Liu, S., Wang, J., Tahir, S., & Patwary, A. K. (2021). Assessing the mechanism of energy efficiency and energy poverty alleviation based on environmental regulation policy measures. *Environmental Science and Pollution Research*, 28, 40858-40870.
- Wu, B., Zhai, B., Mu, H., Peng, X., Wang, C., & Patwary, A. K. (2021). Evaluating an economic application of renewable generated hydrogen: A way forward for green economic performance and policy measures. *Environmental Science and Pollution Research*, 1-15.

# Factors That Influencing Customer's Satisfaction Toward Food Trucks in Kota Bharu, Kelantan

Nurul Huda Binti Sulaiman, Nurul Jannah Binti Mohd, Nurul Rodziah Binti Mohd Rodhi, Nurul Zakirah Binti Muhamad Norrizan  
\* Nor Amira Binti Mohd Razali, Nurul Fardila Binti Abd Razak.

*Faculty of Hospitality, Tourism and Wellness, University Malaysia Kelantan*  
Email: [h20a1673@siswa.umk.edu.my](mailto:h20a1673@siswa.umk.edu.my), [h20a1679@siswa.umk.edu.my](mailto:h20a1679@siswa.umk.edu.my), [h20a1694@siswa.umk.edu.my](mailto:h20a1694@siswa.umk.edu.my), [h20a1707@siswa.umk.edu.my](mailto:h20a1707@siswa.umk.edu.my)

## ABSTRACT

*This empirical study investigates the relationship between customer satisfaction and critical factors such as food quality, service quality, and price and value within the food truck industry in Kota Bharu, Kelantan. The emergence of a new food truck in Malaysia in 2014, offering menu items from restaurants at a lower and more affordable price, gained significant attention and popularity among the public. This research examines the drivers of customer satisfaction in this context. A quantitative research approach was employed, utilizing an online questionnaire to collect data from a sample of 384 respondents. The collected data was then analyzed using SPSS software. The study's findings revealed that customer satisfaction is influenced by three key factors: service quality, food quality, and the price and value of the food trucks offer. This research contributes to existing theory and practice by providing a comprehensive understanding of the factors that impact customer satisfaction regarding service quality, food quality, and price and value within the food truck industry in Kota Bharu, Kelantan.*

**Keywords:** Customer Satisfaction, Food Quality, Service Quality, Price and Value, Food Truck

## INTRODUCTION

This study examines the phenomenon of customer satisfaction within the context of food trucks. By the end of 2016, the number of food trucks in Malaysia had reached approximately 500, encompassing both government-affiliated agencies and independent operators (Ishak, 2016). Food Trucks (2014) defines the food truck business model as a mobile operation that moves from one location to another, preparing and selling meals from a specially equipped van. The growth of the food truck sector can be attributed, in part, to consumer demand for diverse food options at affordable prices (Yoon & Chung, 2018). Notably, Ibrahim (2011) asserts that food trucks offer advantages such as reduced hassle and costs compared to traditional dining establishments, as customers no longer need to worry about reservations or parking.

The advent of a new food truck in Malaysia in 2014, featuring menu items from established restaurants at lower prices (Durai, 2016), has significantly contributed to the rise in popularity of contemporary food trucks among customers in Kota Bharu, Kelantan. Consequently, this popularity has generated various effects and elicited feedback regarding customer satisfaction. Customer satisfaction, defined as the extent to which a product or service meets and exceeds customers' expectations (Homburg & Stock, 2004), is a crucial factor in assessing the performance of food trucks in meeting customer needs and preferences.

In this empirical paper, the researchers aim to explore and analyze the factors

influencing customer satisfaction within the food truck industry, focusing specifically on the context of Kota Bharu, Kelantan. By gaining insights into customer perceptions of food quality, service quality, and pricing and value, the researchers seek to enhance understanding of the

drivers of customer satisfaction and contribute to the existing body of knowledge in this area. The specific objectives for this study as listed below:

1. To identify the relationship between service quality and customer satisfaction towards the food trucks in Kota Bharu, Kelantan.
2. To examine the relationship between food quality and customer satisfaction towards the food trucks in Kota Bharu, Kelantan.
3. To identify the relationship between price and value and customer satisfaction towards the food trucks in Kota Bharu, Kelantan.

### **Significance of the Study**

This study holds significant value for various stakeholders involved in the food truck industry. Firstly, it serves as a valuable resource for academic researchers seeking a comprehensive understanding of the intricacies of the food truck industry. This study offers a detailed overview of the sector by compiling and presenting available data, enabling researchers to delve into food truck-related research with greater insight.

For the food truck industry, this study's findings hold multiple benefits. Firstly, it sheds light on five key advantages the industry offers food truck entrepreneurs and consumers. By identifying these benefits, the study provides entrepreneurs with valuable insights to establish, develop, and sustain customer satisfaction. Additionally, the research findings can assist entrepreneurs and stakeholders in formulating effective marketing strategies that cater to the evolving needs of consumers.

From the consumer's perspective, this study is crucial in enhancing consumer understanding of the food truck industry. It is a guiding resource for prospective consumers, enabling them to make informed decisions and judgments when engaging with the food and beverage sector. Particularly for consumers in Kota Bharu, the study provides accurate and relevant data about food trucks, thus enabling them to assess and select options that align with their preferences.

In conclusion, this study contributes to the body of knowledge regarding the food truck industry and its impact on entrepreneurs, consumers, and researchers. By exploring the factors influencing consumer satisfaction within the food truck sector, the research provides valuable insights for entrepreneurs and assists consumers in making informed choices.

## **LITERATURE REVIEW**

### **Food Quality**

Food quality is a multifaceted aspect subject to individual preferences, evolving consumer demands, regulatory requirements, and advancements in quantitative measurement (Margherita, 2010). It encompasses various attributes or characteristics of a product that significantly influence its appeal to consumers. Seladorai and Zainol (2016) assert that internal and external factors influence food quality. External factors encompass size, color, texture, and flavor, whereas internal factors predominantly pertain to nutrition, chemical composition, and physical attributes.

Radzuan (2020) identifies these factors as the most influential in consumers' food selection and quality evaluation. Additionally, Ibrahim and Mustapha (2018) emphasize the importance of cleanliness, price, and value as essential determinants of food quality. Consequently, prioritizing quality becomes imperative to enhance customer satisfaction. Previous studies have explored numerous attributes associated with food quality, including flavor, healthiness, freshness, presentation, ingredient quality, safety, portion control, halal compliance, nutritional



value, menu variety, aroma, temperature, the introduction of new menu items, hygiene, authenticity, and texture (Zainol & Seladorai, 2016).

In summary, the concept of food quality encompasses a range of characteristics that influence consumers' perceptions and evaluations of food products. It requires consideration of external factors such as appearance and taste and internal factors such as nutritional content. Other essential elements, including cleanliness, price, and value, contribute significantly to overall food quality. Previous research has examined various attributes associated with food quality, revealing the multifaceted nature of this concept in the eyes of consumers.

### **Service Quality**

The alignment between customer expectations and perceived performance influences client satisfaction. In the context of food trucks, service quality plays a crucial role in shaping customer reactions and overall satisfaction. It involves the processes of packaging, product creation, and the mechanisms employed in selling food items. Service quality refers to the ability of a business to meet the high standards set by its customers. Effective management and continuous improvement of service quality led to increased profitability and ensure customer happiness (Indeed Editorial Team, 2021).

Previous studies have highlighted the priority given by customers to the level of service provided by food truck vendors, as opposed to solely evaluating the visual presentation of the meal. The emphasis on high-quality service has become increasingly significant as it is vital in attracting new customers and retaining existing ones, resulting in profitability. It is through addressing customers' unique needs that food truck services can foster customer loyalty and enhance their overall experience.

In summary, customer satisfaction within the food truck industry depends on the congruence between customer expectations and perceived performance. Service quality, encompassing various aspects of packaging, product creation, and sales mechanisms, is pivotal in shaping customer reactions and overall satisfaction. The management and improvement of service quality contribute to business profitability and ensure customer happiness. Recognizing the importance of service quality over the mere visual appeal, food truck vendors can foster customer loyalty and drive success by addressing the specific needs of their clientele.

### **Price and value**

Value-based pricing is a pricing approach that determines fees based on the consumer's perceived value of a product. This method prioritizes the needs and preferences of the consumer, leading businesses to set their prices based on what they believe customers should pay for a particular product (Bloomenthal, 2022). In the context of food service providers in cafeterias, students often seek affordable pricing due to their limited financial resources, which significantly influences their decision-making process. Nadzirah et al. (2013) similarly identified budget considerations as a crucial factor in the day-to-day operations of academic dining services, given the limited opportunities available to students. The provision of affordable pricing satisfies consumers in terms of the value they receive for their money and facilitates cost adjustments when necessary.

As defined by Kotler and Armstrong (2012), price refers to the charges associated with a product or service. It represents the total amount exchanged for the benefits derived from using or consuming the product or service. Ensuring an adequate pricing policy increases customer satisfaction and facilitates the flexibility to adjust costs as needed. In summary, value-based pricing considers consumers' perceived value of a product or service when determining fees. Students' limited financial resources drive their preference for affordable pricing in the context of cafeteria food service providers. This consideration significantly influences their decision-making process. By offering affordable prices, businesses can satisfy consumers in terms of the perceived value they receive, and it also allows for greater flexibility in cost adjustments. Price, as a concept, represents the total amount exchanged for the benefits derived from a product or service.

## Customer Satisfaction

Client satisfaction evaluates whether a product or service meets or exceeds a customer's expectations (Homburg & Stock, 2004). In order to achieve the potential for customer satisfaction, service providers must deliver outstanding service quality, as emphasized by Rahim et al. (2015). Customer satisfaction plays a crucial role in the success of businesses, enabling them to maintain a competitive advantage in the market. It also significantly impacts repeat business, word-of-mouth advertising, and purchasing intentions (Zhang et al., 2013). Previous research has consistently highlighted the importance of high-quality products and services in satisfying customers (Padma & Austuti, 2016). Consequently, when consumers derive satisfaction from products and services, and a company's performance aligns with their expectations, both parties' benefit (Santouridis & Trivellas, 2010).

## Hypothesis

The research hypothesis of this study focuses on the factors that contribute to customer satisfaction in the context of food trucks in Kota Bharu, Kelantan. Specifically, the hypothesis looks at how customer satisfaction is affected by the quality of the food, the quality of the service, the quality of the physical environment, and the pricing and value. In light of the research objectives, the formulated hypothesis is as follows:

**H1:** There is a relationship between food quality and customer satisfaction toward food trucks in Kota Bharu, Kelantan.

**H2:** There is a relationship between service quality and customer satisfaction toward food trucks in Kota Bharu, Kelantan.

**H3:** There is a relationship between pricing and value and the customer satisfaction toward food trucks in Kota Bharu, Kelantan.

## Conceptual Framework

A research framework has been developed to identify the relationship between the food quality and service quality, price, and value with customer satisfactions toward food trucks in Kota Bharu, Kelantan.

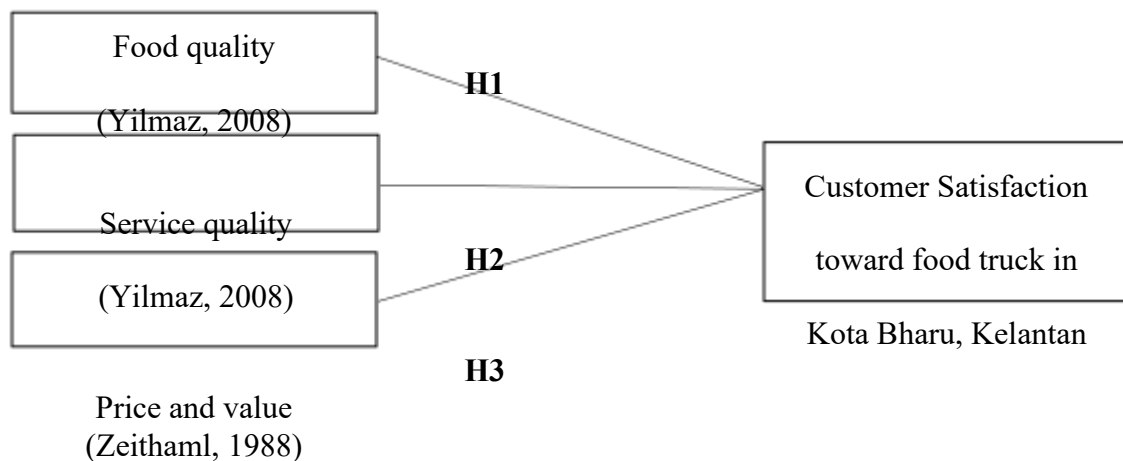

## METHODOLOGY

### Research Design

To effectively meet the research objectives, this study used a quantitative research technique that focuses on gathering precise and quantifiable data. A questionnaire approach was used as part of the study procedure to gather primary data. A preset series of questions intended to collect information from respondents made up the questionnaire, which was used as a research instrument. Respondents could choose between agreeing or disagreeing with statements pertaining to the survey's study goals using a Likert scale with five response possibilities. The researchers wanted to learn more about the dynamics of the food truck market, therefore they investigated the correlations between these factors.

### Data Collection

The researchers focused on collecting primary data for this empirical study. Primary data refers to original and firsthand information gathered by the investigator to meet the research requirements. The data was sourced from authentic and reliable sources, including the study participants' and the researchers' perspectives. In order to collect the necessary data, The researchers employed survey and questionnaire methods. Specifically, this project used a Google Form as the data collection tool. The Google Form link was disseminated through various online platforms such as WhatsApp, Instagram, and Facebook to ensure a broad range of respondents. Additionally, the questionnaire was posted on survey websites to attract a broader range of participants.

### Sampling

A non-probability sampling method was employed for the empirical study on consumer satisfaction with food trucks in Kota Bharu, Kelantan. Specifically, convenience sampling was emphasized as the chosen approach for data collection. Convenience sampling is selected for its efficiency and simplicity, offering various options for participant selection (Etikan, 2016). The study focuses on customers using food truck services to purchase meals in Kota Bharu, Kelantan, making convenience sampling an appropriate sampling technique.

### Data Analysis

Statistical Package for Social Sciences (SPSS) version 26.0 was used to analyze the data acquired from the Google Form. Descriptive statistics including mean, median, mode, and frequencies were used to analyze the data. Using Pearson correlation analysis, the relationships between the variables in the dataset were also looked at.

## FINDINGS

The demographic profile of the respondent was summarized in the Table 1 below.

**Table 1: The Demographic Characteristics of the Respondents**

Demographic/ Characteristic	Category	Frequency	Percentage (%)
Gender	Male	178	46.4
	Female	206	53.6
Age	< 20 years	26	6.8
	31 – 30 years	346	90.1
	31 – 40 years	2	0.5
	> 41 years	10	2.6
Income	< RM 600	299	77.9
	RM 600 – RM 1000	29	7.6
	RM 1001 – RM 2000	32	8.3
	RM 2001 – RM 3000	11	2.9
	RM 3001 – RM 4000	4	1.0
	> RM4000	9	2.3

Level of Education	SPM	25	6.5
	STPM	14	3.6
	DIPLOMA	45	11.7
	BACHELOR DEGREE	299	77.9
	POSTGRADUATE	1	0.3
Do you have any experience buying food at food truck	YES	382	99.5
	NO	2	0.5

Table 1 presents the demographic characteristics of the respondents in this empirical study. Most of the respondents, constituting 91% of the total, fell within the age range of 21 to 30 years. Among the respondents, 53.6% identified as female, while 46.4% identified as male. Furthermore, a significant proportion of the respondents (77.9%) reported earning less than RM600 monthly. Regarding educational attainment, 77.9% of the respondents held bachelor's degrees. Notably, only a small percentage (2%) of the respondents reported did not having any experience purchasing food from a food truck, thus was discarded from the study. Next, the descriptive analysis was presented in the Table 2.

**Table 2: The Descriptive Statistics of Independent Variables and Dependent Variable.**

Item	Mean score	Standard deviation
<b>IV 1: Service Quality</b>		
7. Knowledge and attentive food truck staff is a valuable asset for one's success.	4.31	
8. Immediate responses to customer needs are paid attention to by the entrepreneur's food truck.	4.24	
9. The employees are able and willing to give the detailed information about the menu, ingredients and method of preparation.	4.31	0.682 0.714 0.729
10. The friendly and welcoming service is essential to attract more customers.	4.22	
	4.25	0.864 0.727
<b>IV 2: Food Quality</b>		
2. The freshness of food truck is nice.	4.40	
3. The food presentation in the food truck is attractive.	4.25	
4. Tasty and delicious food is factor that is very important for food truck customers.	4.32	0.719 0.736
5. The freshness of ingredients and ingredients is concerns	4.45	0.707 0.706
<b>IV 3: Price and Value</b>		
3. The food provided must be worth the value of money paid.	4.31	
4. The cost in the food truck seems appropriate for what I get.	4.24	
5. Cheap prices for food are important even if it doesn't taste good.	4.24	0.682 0.714 0.729 0.864 0.729
6. Menu in food trucks must be easily readable and detailed.	4.22	
7. Possible and affordable prices enable us to meet customer's expectations and needs.	4.22	
	4.25	

Table 2 presented the mean scores and standard deviations of each variable in the study. The variable "Service Quality" obtained a mean score of 4.266. The highest mean score within this variable was attributed to knowledgeable and attentive food truck staff, regarded as a valuable asset for success. The employees' ability and willingness to provide detailed information about the menu, ingredients, and preparation methods also received a high mean

score of 4.31. As opposed to that, the item "The friendly and welcoming service is essential to attract more customers" obtained the lowest mean score of 4.22. Most respondents emphasized the importance of attitude in determining consumer acceptance of changes in food trucks. Respondents believe that creatively prepared food from food trucks saves time and provides a sense of familiarity.

The mean score for the variable "food quality" was higher at 4.355. The freshness of ingredients emerged as a significant concern among respondents when considering food truck options, with a mean score of 4.45. Conversely, the attractiveness of food presentation in food trucks obtained the lowest mean score of 4.25. When evaluating food quality, various material and immaterial product aspects, including the product itself, production environment, product-packaging system, and product market system, need to be considered (Margherita, 2010).

Lastly, the variable "Price and Value" obtained a mean score of 4.252. The highest mean score of 4.31 was associated with the perception that the food provided by food trucks must be worth the value of the money paid. As opposed to that, the lowest mean score of 4.22 was linked to the expectation that menus in food trucks should be easily readable and detailed. Value pricing, which prioritizes consumer needs, allows businesses to set prices based on what they believe customers should pay for a product (Bloomenthal, 2022). When the price is reasonable, customers are satisfied with the quality of the product and the value of their purchase. Additionally, a fair pricing strategy facilitates adjustments to prices when necessary. Customers experience satisfaction when the value-to-price ratio meets or exceeds their expectations.

The result for reliability test was summarized in the Table 3 as below.

**Table 3: Reliability of statistics of the Independent Variable (IV) and Dependent Variable (DV).**

<b>Item</b>	<b>Number of Item</b>	<b>Cronbach's Alpha Coefficient</b>	<b>Strength of Association</b>
<b>Service Quality</b>	5	0.832	Very good
<b>Food Quality</b>	4	0.797	Good
<b>Price and Value</b>	5	0.832	Very Good
<b>Customer Satisfaction</b>	4	0.758	Good

Table 3 provides the reliability and validity of the questionnaire used in the study. The Cronbach's Alpha coefficient was calculated to assess the internal consistency of the items. For the Service Quality and Price and Value items, Cronbach's Alpha coefficient yielded a value of 0.832, indicating an excellent and outstanding result. Similarly, for the item of Food Quality, the Cronbach's Alpha coefficient was 0.797, and for Customer Satisfaction, it was 0.758. Both coefficients indicate a "good" level of strength of association. The different number of items in each variable should be noted, with Service Quality and Price and Value comprising five items, while Food Quality and Customer Satisfaction have four items.

Overall, the coefficients obtained for the variables demonstrate acceptable and reliable results. The high Cronbach's Alpha values suggest the questionnaire consistently measured the constructs under investigation. Consequently, the questionnaire administered to the 384 respondents can be deemed trustworthy and suitable for conducting the research. These findings indicate that respondents understood the questions and responded acceptably, confirming the questionnaire's reliability.

Pearson correlation analysis was employed to examine the statistical significance or

strength of the relationship between the independent variable (IV) and dependent variable (DV). The results of the Pearson correlation analysis are presented in Table 4.

**Table 4: Pearson's correlation between Service Quality, Food Quality and Price and Value on Customer Satisfaction.**

		<b>Customer Satisfaction</b>
<b>Service Quality</b>	Pearson Correlation	.519**
	Sig. (2-tailed)	<.001
	N	384
<b>Food Quality</b>	Pearson Correlation	.584**
	Sig. (2-tailed)	<.001
	N	384
<b>Price and Value</b>	Pearson Correlation	.584**
	Sig. (2-tailed)	<.001
	N	384

\*\* . Correlation is significant at the 0.01 level (2-tailed).

Table 4 presents the Pearson correlation coefficients for the variables under investigation. All correlation coefficients reported in the table are statistically significant at the  $p < .001$  level, indicating a high confidence level in the observed relationships. The results reveal that Food Quality and Price and Value share a Pearson correlation coefficient of .584\*\*, while Service Quality has a correlation coefficient of .519\*\* with the other variables. These findings suggest a positive association between the variables, with moderate positive correlations observed. The positive values indicate that the other variables also tend to increase as one variable increases. The magnitude of the correlation coefficients implies a moderate strength of the relationships between the variables. Overall, the analysis highlights significant positive correlations among the variables, underscoring the interconnectedness and interdependence of Food Quality, Price and Value, and Service Quality in the study context.

## DISCUSSION AND RECOMMENDATIONS

According to the study's results, a moderate strength of the relationship was found between customer satisfaction and service quality ( $r = 0.519$ ,  $n = 384$ ,  $p 0.001$ ). This finding indicates that employing food trucks, service quality and customer satisfaction have a positive and substantial link in Kota Bharu, Kelantan. When the performance of the food truck meets or exceeds customer expectations, it leads to customer satisfaction. This findings is supported the previous study by Kataria and V.Saini (2019). Furthermore, the study also found evidence supporting H2, it suggests a connection between the calibre of the cuisine and client happiness. The findings showed a moderately strong correlation between customer satisfaction and meal quality ( $r = 0.584$ ,  $n = 384$ ,  $p 0.001$ ). This finding suggests that there is a significant and positive relationship between customer satisfaction and the caliber of food served by food trucks in Kota Bharu, Kelantan. This finding validated from the previous scholar research by M. Henchion et al. (2014).

Additionally, the study examined the relationship between price and value of food and customer satisfaction, as suggested by H3. The analysis revealed a similar strength of the relationship between price and value and customer satisfaction as the service quality relationship ( $r = 0.519$ ,  $n = 384$ ,  $p < 0.001$ ). This result indicates that the price and value of food served by food trucks also significantly influence customer satisfaction. This finding is supported by the previous study by Shin et al. (2018). Overall, the findings support the hypotheses and demonstrate the importance of service quality, food quality, and price and value in determining customer satisfaction when using food trucks in Kota Bharu, Kelantan.

This study has certain limitations that should be acknowledged. Firstly, the research was limited to respondents residing in Kota Bharu, Kelantan, which may restrict the generalizability of the findings to a broader population. Therefore, it is recommended to include participants from various locations across Malaysia rather than focusing solely on one specific region as to enhance the comprehensiveness and representativeness of future studies. This strategy would provide a more comprehensive understanding of consumer satisfaction with food trucks in the country.

Secondly, data was collected through a Google Form distributed via social media platforms. While this method offers convenience and wide accessibility, it poses potential challenges regarding respondent comprehension of the survey questions. Respondents may need help navigating the lengthy questionnaire, leading to potential response biases or incomplete data. In order to mitigate these limitations, future studies could consider conducting face-to-face interviews or surveys in an actual setting. This method would allow respondents to seek clarification or ask questions in real time, ensuring a better understanding of the questionnaire and improving the quality of the collected data.

By addressing these limitations in future research, a more comprehensive and robust understanding of consumer satisfaction with food trucks can be achieved, encompassing a broader population and employing data collection methods that promote more transparent comprehension and greater respondent engagement.

## CONCLUSION

In conclusion, this study explored the factors influencing consumer satisfaction with food trucks in Kota Bharu, Kelantan. The findings revealed valuable insights into the key determinants of customer satisfaction in this context. The results demonstrated that service quality, food quality, price, and value significantly influence customer satisfaction. Specifically, factors such as knowledgeable and attentive staff, detailed information about the menu and ingredients, freshness of ingredients, and reasonable pricing were found to impact customer satisfaction positively.

The study's findings add to the body of research by offering concrete proof of the elements that influence consumer happiness in the food truck sector. The results emphasize the importance of delivering high-quality services, ensuring the freshness and presentation of food, and offering competitive pricing to meet customer expectations. These findings can guide food truck operators, policymakers, and industry stakeholders in enhancing their strategies and practices to maximize customer satisfaction and loyalty. Overall, this study contributes to the body of knowledge on customer satisfaction in the food truck industry and provides practical implications for food truck operators and policymakers to enhance the overall dining experience and meet customers' evolving expectations.

## REFERENCE

- Ahmad, M. et al. (2016) - *researchgate*, *Genetic variability in Cirsium arvense under different environmental conditions*. Available at: [https://www.researchgate.net/publication/329885161\\_Ahmad\\_et\\_al](https://www.researchgate.net/publication/329885161_Ahmad_et_al) (Accessed: 01 July 2023).
- Akter, M., Sadekin, M. N., & Patwary, A. K. (2020). An Empirical Study on Students' Satisfaction from Mawlana Bhashani Science & Technology University, Bangladesh. *Review of Economics and Development Studies*, 6(2), 363-379.
- Al Mahmud, S. R. (2020). The effectiveness of Facebook advertisements on purchase intention of customers in Malaysia. *South Asian Journal of Social Sciences and Humanities*, 1(1), 97-104.

- Alom, S., Patwary, A. K., & Khan, M. M. H. (2019). Factors affecting the turnover intention of Bangladeshi migrants in the United Arab Emirates: An empirical study on the hotel industry. *International Journal of Innovation, Creativity and Change*, 8(3), 344-360.
- Fengmin, Z., Baijun, W., Jiangtao, B., Li, L., & Patwary, A. K. (2022). Investigating revisit intention of medical tourists in China through nutritional knowledge, perceived medical quality, and trust in the physiologist: A recommendation on health tourism policy measures. *Frontiers in Public Health*, 10, 893497.
- GMA News Online (1970) *Food Trucks among the small business hits-to-be of 2014*, *GMA News Online*. Available at: <https://www.gmanetwork.com/news/lifestyle/food/342221/food-trucks-among-the-small-business-hits-to-be-of-2014/story/> (Accessed: 02 July 2023).
- Hazbar, A. M. H., Alem Mohammed, A., & Karim, A. K. A. (2019). An Empirical Study of Factors Influencing hotel customers' online booking Intention. *مجلة العلوم التربوية و الدراسات الإنسانية*, (5), 1-17.
- Henchion, M. *et al.* (2014) 'Meat consumption: Trends and quality matters', *Meat Science*, 98(3), pp. 561–568. doi:10.1016/j.meatsci.2014.06.007.
- Hidayat. *et al* (2021) *A study of service quality on customer satisfaction and its impact on ...*, *A Study of Service Quality on Customer Satisfaction and its Impact on Customer*
- Homburg, C. and M. Stock, R. (2004) *The Link Between Salespeople's Job Satisfaction and Customer Satisfaction in a Business-to-Business Context: A Dyadic Analysis*. Available at: [https://www.scirp.org/\(S\(czeh2tfqyw2orz553k1w0r45\)\)/reference/ReferencesPapers.aspx?ReferenceID=1162884](https://www.scirp.org/(S(czeh2tfqyw2orz553k1w0r45))/reference/ReferencesPapers.aspx?ReferenceID=1162884) (Accessed: 02 July 2023).
- Ibrahim, A. *et al.* (2019) (PDF) *ibrahim et al 2018 J hyp mgt - researchgate*, *Nigerian Citrullus Lanatus Fruit and Seed Juice Reduces Cardio-vascular Diseases Modifiable Risk Biomarkers in Normal Experimental Rats*. Available at: [https://www.researchgate.net/publication/331011242\\_Ibrahim\\_et\\_al\\_2018\\_J\\_Hyp\\_Mgt](https://www.researchgate.net/publication/331011242_Ibrahim_et_al_2018_J_Hyp_Mgt) (Accessed: 01 July 2023).
- Ishak, S. *et al.* (2016) *Journal of Islamic Marketing - Researchgate*, *Journal of Islamic Marketing A study on the mediating role of halal perception: determinants and consequence reflections Article information*: Available at: [https://www.researchgate.net/profile/Suraiya-Ishak/publication/308260116\\_Journal\\_of\\_Islamic\\_Marketing\\_A\\_study\\_on\\_the\\_mediating\\_role\\_of\\_halal\\_perception\\_determinants\\_and\\_consequence\\_reflections\\_Article\\_information\\_For\\_Authors/links/5a80e4af4585154d57d90d9d/Journal-of-Islamic-Marketing-A-study-on-the-mediating-role-of-halal-perception-determinants-and-consequence-reflections-Article-information-For-Authors.pdf?\\_sg%5B0%5D=started\\_experiment\\_milestone&origin=journalDetail](https://www.researchgate.net/profile/Suraiya-Ishak/publication/308260116_Journal_of_Islamic_Marketing_A_study_on_the_mediating_role_of_halal_perception_determinants_and_consequence_reflections_Article_information_For_Authors/links/5a80e4af4585154d57d90d9d/Journal-of-Islamic-Marketing-A-study-on-the-mediating-role-of-halal-perception-determinants-and-consequence-reflections-Article-information-For-Authors.pdf?_sg%5B0%5D=started_experiment_milestone&origin=journalDetail) (Accessed: 01 July 2023).
- Kataria, S. and Saini, V. (2019) *The mediating impact of customer satisfaction in relation of Brand Equity and brand loyalty: An empirical synthesis and re-examination*, *South Asian Journal of Business Studies*. Available at: <https://www.emerald.com/insight/content/doi/10.1108/SAJBS-03-2019-0046/full/html> (Accessed: 02 July 2023).
- Li, L., Ragavan, N. A., Patwary, A. K., & Baijun, W. (2022). Measuring patients' satisfaction toward health tourism in Malaysia through hospital environment, nutritional advice, and perceived value: A study on Chinese exchange students. *Frontiers in public health*, 10, 893439.



- Li, L., Wu, B., & Patwary, A. K. (2022). How marine tourism promote financial development in sustainable economy: new evidences from South Asia and implications to future tourism students. *Environmental Science and Pollution Research*, 29, 1155-1172.
- Li, L., Wu, B., & Patwary, A. K. (2022). The psychosocial factors affecting chinese Outbound Exchange and mobility students' academic performance during COVID-19. *Frontiers in psychology*, 13, 872516.
- Loyalty: The Case of Food and Beverage Industry in Bandung*. Available at: <https://bircu-journal.com/index.php/birci/article/download/2910/pdf> (Accessed: 01 July 2023).
- Mayliza, R. (2019) *Analisis customer satisfaction dan behavioral intention Dilihat Dari Dari*
- Mokhtar, R. et al. (2018) *Dimensions of brand equity in the Food Truck Business, International Journal of Academic Research in Business and Social Sciences*. Available at: <https://hrmars.com/index.php/IJARPED/article/view/5223/Dimensions-of-Brand-Equity-in-the-Food-Truck-Business> (Accessed: 02 July 2023).
- Nadzirah, S. et al. (2013) *University foodservice: An overview of factors influencing the customers' dining choices* [Preprint]. doi: [https://www.researchgate.net/publication/288568879\\_University\\_foodservice\\_An\\_overview\\_of\\_factors\\_influencing\\_the\\_customers'\\_dining\\_choice](https://www.researchgate.net/publication/288568879_University_foodservice_An_overview_of_factors_influencing_the_customers'_dining_choice).
- Patwary, A. K., Roy, B., Hoque, R., & Khandakar, M. S. A. (2019). Process of developing a community based tourism and identifying its economic and social impacts: An Empirical study on Cox's Bazar, Bangladesh. *Pakistan Journal of Humanities and Social Sciences*, 7(1), 1-13.
- Service Qaulity, Food Quality dan Price/Value di Restoran McDonald's Depok* at: [https://www.researchgate.net/publication/331964357\\_](https://www.researchgate.net/publication/331964357_) (Accessed: 01 July 2023).
- Mokhtar, R. et al. (2017) *Brand equity and customer behavioural intention: A case of food truck business*, 9. doi:[https://www.researchgate.net/publication/329698378\\_Brand\\_equity\\_and\\_customer\\_behavioural\\_intention\\_A\\_case\\_of\\_food\\_truck\\_business](https://www.researchgate.net/publication/329698378_Brand_equity_and_customer_behavioural_intention_A_case_of_food_truck_business).
- Shin, Y.H., Kim, H. and Severt, K. (2019) 'Consumer values and service quality perceptions of food truck experiences', *International Journal of Hospitality Management*, 79, pp. 11–20. doi: 10.1016/j.ijhm.2018.12.008.
- Students in Entrepreneurship Education*, pp. 1–8. doi: <https://ir.uitm.edu.my/id/eprint/42465/1/42465.pdf>.
- Studocu, S. (2023) *YGL Malaysia- Financial Ratio*. Available at: <https://www.studocu.com/my/document/open-university-malaysia/business-and-management/ygl-malaysia-financial-ratio-intan/45712415> (Accessed: 02 July 2023).
- Syed Annuar, S.N. et al. (2016) *Comparing Performance of Business and Non-business*
- Sumethokula, P., Patwary, A. K., Srinuanpanc, B., Srinuanpand, C., Suwandee, P., Thammathikul, A., & Phanong, W. (2020). The potential of new tour repackaging for creative tourism among entrepreneurs in Nakhon Si Thammarat. *International Journal of Innovation, Creativity and Change*, 13(10), 1752-1771.
- Wu, B., Liu, S., Wang, J., Tahir, S., & Patwary, A. K. (2021). Assessing the mechanism of energy efficiency and energy poverty alleviation based on environmental regulation policy measures. *Environmental Science and Pollution Research*, 28, 40858-40870.
- Wu, B., Zhai, B., Mu, H., Peng, X., Wang, C., & Patwary, A. K. (2021). Evaluating an economic application of renewable generated hydrogen: A way forward for green economic performance and policy measures. *Environmental Science and Pollution Research*, 1-15.

Yoon, B. and Chung, Y.K. (2017) *Consumer attitude and visit intention toward food-trucks: Targeting ...*, *Consumer Attitude and Visit Intention toward Food-Trucks: Targeting Millennials*. Available at: [https://www.researchgate.net/publication/321328002\\_Consumer\\_Attitude\\_and\\_Visit\\_Intention\\_toward\\_Food-Trucks\\_Targeting\\_Millennials](https://www.researchgate.net/publication/321328002_Consumer_Attitude_and_Visit_Intention_toward_Food-Trucks_Targeting_Millennials) (Accessed: 01 July 2023).

# Consumer Perception of Food Safety at Restaurant in Kota Bharu, Kelantan

Nurulhuda binti Saidon, Prinah A/P Balakrishnan, Raihan  
Hanis binti Rusman, Rohaizie Azieyra binti Ibrahim &  
\*Abdullah Muhammad Yusoff

*Faculty of Hospitality, Tourism and Wellness, University Malaysia Kelantan  
Corresponding email: abdullah.my@umk.edu.my*

---

## ABSTRACT

*Food safety is a great concern to consumers in terms of the nature of the food that allows consumers to have negative health effects. There are many cases related to food poisoning that happen due to poor hygiene practice and lack of understanding about food safety. The goal of this study is to examine the relationship between the food quality, service quality and restaurant ambience among consumer perception of food safety. The questionnaire is distributed to the 384 respondents at Kota Bharu, Kelantan. The analysis for this study is using SPSS software version 2.4. This study analyzed the descriptive analysis, reliability test, and Pearson's correlation analysis. This empirically finding service quality and consumer perception is good to support the hypotheses for this study. Therefore, food quality, service quality, and restaurant ambience can influence the customer perception of the casual dining restaurant.*

**Keywords:** Food Safety, Consumer Perception, Food Quality, Service Quality, Restaurant Ambience, Kota Bharu, Casual Dining Restaurant

---

## INTRODUCTION

Food safety is of great concern to consumers in terms of the nature of the food that allows consumers to have negative health effects. Therefore, food safety is an important consideration while handling it, especially in settings where it is served, such as street food. To avoid exposing consumers to foodborne pathogens that can cause food poisoning and negatively impact human health, food safety is a crucial issue that must be treated carefully (Fatin et al,2021). This study intends to investigate the consumers' perception of food safety at restaurants in Kota Bharu, Kelantan. In addition, consumers care about how well they grasp hygienic procedures and food safety. Furthermore, food safety not practiced correctly when food handlers do not comply with personal hygiene such as washing hands before preparing food will cause-contamination through direct contact between raw materials and cooked food, and unsanitary food preparations place (Chang et al., 2014). During the Covid-19 pandemic, the number of incidents of food poisoning decreased by 31.6%, from 288 cases in 2020 to 197 cases in 2021. But the number of food poisoning cases during Ramadan increased from 22 cases in 2020 to 39 cases in 2021 because them not washing their hands before and after preparing food, using the same utensils for raw food, and not following standard operating procedures and adopt a new norm in the bazaar (Abdullah, 2022).

There are three objectives of this research:

1. To examine the relationship between food quality and the consumer perception of food safety.
2. To examine the relationship between service quality and consumer perception of food safety.
3. To examine the relationship between restaurant ambience and consumer perception of food safety.

## **Significant of the Study**

### **Community**

Information on consumer perception about food safety can bring benefits for the surrounding community and will continue to be aware of food safety in the future.

### **Restaurant Industry**

The benefits and disadvantages of the emerging industry must be evaluated against potential difficulties, one of which is identifying potential food safety issues that can affect consumer health.

### **Food Handling Practice**

The cleanliness of the food prepared in restaurants nowadays and how to handle the food is important. Poor personal cleanliness among food handlers, incorrect refrigerator temperatures, lack of understanding about food safety, and faulty cooking all increase the risk of foodborne illness in restaurants (Collins, 1997).

## **LITERATURE REVIEW**

### **Food Quality**

Food quality must be consistent and reliable when providing to consumers in terms of freshness, temperature, taste, and presentation (Namkung & Jang, 2007). When choosing a restaurant to eat, consumers are more likely to think about the food's quality because it will help them form a favorable impression.

Based on a study conducted by (Sulek & Hensley, 2004), the most crucial element that might affect consumer impression and the reason why people choose a restaurant, they discovered is the food quality. Additionally, it is backed by (Ha & Jang, 2010), which found a connection between customer loyalty and food quality.

## **Service Quality**

Service is an intangible or performance that one party offered to consumers. Service quality is a valuable characteristic and features which are important such as reliability, responsiveness, and empathy. For example, for tangibility it can provide a physical facility and facilitating goods. Consumers who always look in a product such as food to know how the service that will provide in restaurant.

Therefore, a restaurant who given a good service quality in terms of food safety will be able to maintain a loyal consumer. While poor service quality can lead the consumers to choose the other restaurant.

## **Restaurant Ambience**

Restaurant ambience plays an important role in creating a restaurant's reputation and luring diners in. Customers will visit restaurants if the exterior and interior are appealing. (Omar et al., 2015). A clean and safe ambience will guarantee food safety in the restaurant.

Customers might not come to a restaurant just for the cuisine on their first visit, but additional elements like an appealing exterior design, favorable media coverage, or word-of-mouth recommendations. The customer's view of the eating experience must be influenced by the decor, atmosphere, and service standards. The environment affects how diners react and judge a restaurant (Lim, 2010).

## **Consumers Perception of Food Safety**

Perception is a major psychological factor influencing people's purchase decision (Kotler & Armstrong, 2011). It is described as the act of seeing and understanding environmental information via the use of the four senses of vision, listening, tasting, and touching. Consumers' perception of food safety and their inclinations to purchase as well as their understanding of how high food hygiene standards affect the environment and society.

## **Research Hypothesis**

In this study, there are three hypotheses that have been tested:

H1: There is a significant relationship between food quality and consumers perception of food safety at restaurants in Kota Bharu, Kelantan.

H2: There is a significant relationship between service quality and consumers perception of food safety at restaurants in Kota Bharu, Kelantan.

H3: There is a significant relationship between restaurant ambience and consumers perception of food safety at restaurants in Kota Bharu, Kelantan.

## **Research Framework**

The relationship between the study's variables has been investigated using a research framework. The independent variables that have been proposed

consist of three which are food quality (Huang et al., 2004; Mohi, 2012; Shaharudin et al., 2011), service quality (Parasuraman et al., 1985 & 1988), and restaurant ambience (Heung & Gu, 2012; Jalil et al., 2016; Kement et al., 2021; Stroebele & De Castro, 2004; Wu & Mohi, 2015). On the other hand, a dependent variable is consumer perception of food safety.

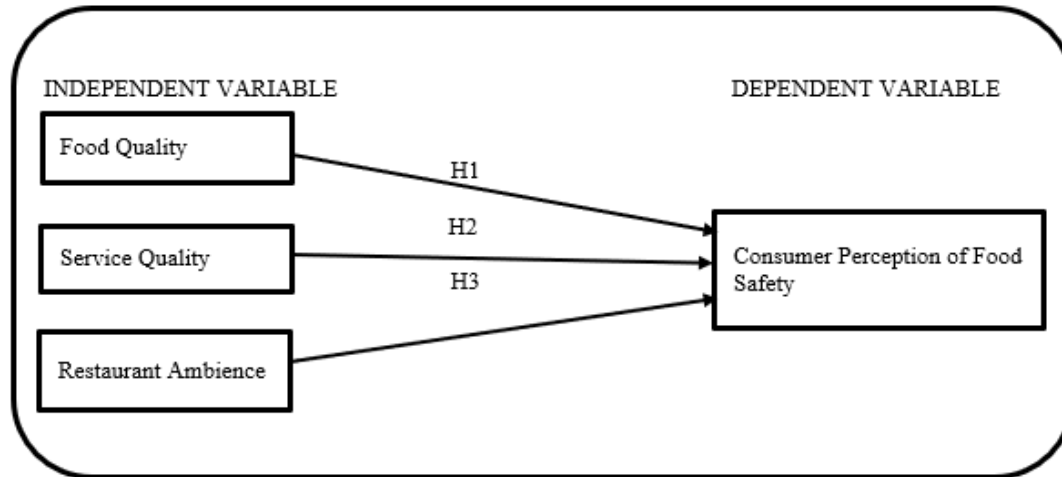

Figure 1: Conceptual Framework Consumer Perception of Food Safety at Restaurant in Kota Bharu, Kelantan

## METHODOLOGY

### Research Design

The quantitative research method will be used in this study. This research utilized a questionnaire to perform the survey. The questionnaire was created to elicit all data relevant to the objectives of the study. The survey was divided into six sections: section A covered demographic background; section B covered frequency and reasons for dining at casual dining establishments; section C covered food quality; section D covered service quality; section E covered restaurant ambience; and section F covered consumer perceptions of food safety. In the section, the Likert Scale was used to calculated on a 5-point scale (1 strongly disagreed to 5 strongly agreed).

### Data Collection

Primary data is the use for this research. Primary data are those gathered by the researcher directly from sources like questionnaires. The questionnaire will be conducted online for respondents. In addition, this research provides 20 questionnaires. The pilot study was also used for testing the questionnaire to get useful feedback from respondents and the researcher can revise and improve the questions before publication.

## Sampling

In this study, convenience sampling was used. Because not everyone has an equal chance of getting chosen, it will be chosen using non-random criteria in a convenience sample. The targeted population are the consumers who eat at casual dining restaurants around Kota Bharu, Kelantan. Sample size is a subset of the population needed to ensure that information is sufficient. Due to the large number of people in Kota Bharu, Kelantan which are 363,000 persons (DOSM, 2023). Therefore, 384 participants from the table in (Krejcie & Morgan's, 1970) constitute the proper sample size for this investigation. Convenience sampling is a technique used to collect data from a group of readily accessible respondents. Due to its speed, simplicity, and low cost, it is the most popular sampling technique (Sukhtatme, 2008).

## Data Analysis

In this study, three different forms of data analysis were used: descriptive analysis, reliability analysis, and Pearson correlation. The results were examined using SPSS version 24, a Statistical Programme for Social Science, to analyze the information collected from the questionnaire.

The descriptive analysis includes the central tendencies and the measure of variability. Standard deviation, variance, minimum and maximum variation, kurtosis, and skewness are among the measurements of variability, whereas mean, median, and mode are among the indicators of central tendency. Researchers can understand the data more efficiently by using descriptive analysis. The average was evaluated as Strongly Disagree 1.00–1.80, Disagree 1.8–2.60, Neutral 2.6–3.40, Agree 3.4–4.20, and Strongly Agree 4.21–5.00.

Reliability analysis means the verifying the general, group and specific factors among the items, as the consistency of the result in the factors from test to test. In this study, Cronbach's Alpha was utilised to evaluate the questionnaire's reliability. The association's strength is classified as follows: <0.6 poor, 0.6 to <0.7 moderate, 0.7 to <0.8 good, 0.8 to <0.9 very good, and 0.9 excellent.

The Pearson Correlation method, which was the most widely used method for analyzing numerical variables, was given values between 0 and 1, with 1 signifying total positive correlation and 0 denoting total negative correlation (Boslaugh et al., 2008). In the following interpretation, a correlation value of 0.7 between two variables indicates a significant and positive relationship between them (Steven Nickolas, 2021).

## FINDINGS

Table 1: Demographic Analysis

Demographic	Categories	Frequency (N)	Percentage (%)
Gender	Male	156	40.6
	Female	228	59.4
Age	Below 18	16	4.2
	18-24	267	69.5
	25-34	70	18.2
	35-44	21	5.5
	45 and above	10	2.6
Race	Malay	269	70.1
	Chinese	55	14.3
	India	58	15.1
	Others	2	0.5
Marital Status	Married	52	13.5
	Single	332	86.5
	Others	0	0
Education Level	Primary School	5	1.3
	Secondary School	57	14.8
	Diploma	66	17.2
	Degree	243	63.3
	Masters	8	2.1
	PhD	5	1.3
Occupation Level	Students	169	44.0
	Employed Part Time	105	27.3
	Employed	93	24.2
	Unemployed	16	4.2
	Retired	1	0.3
Income Level	Below RM2000	176	45.8
	RM2001-RM3000	145	37.8
	RM3001-RM4000	42	10.9
	Above RM4000	21	5.5

The demographic analysis of the respondents is shown in Table 1. That show that out of 384 respondents, there were 59.4% more female respondents than male respondents 40.6%. The age group with the greatest percentage, 18 to 24 years old, had a rate of 69.5%. The second largest percentage, 18.2%, was among those between the ages of 25 and 34. The third age group, 35 to 44, has 5.5%. 4.2% of people are below 18 in the fourth age group. The lowest percentage, 2.6%, was found in people over the 45 and above. Most of the respondents that were involved were Malay, which consists of 70.1%. The second highest was Indian, which made up 15.1%. The remaining respondents were Chinese and other races, which consists of 14.3% and 0.5% respectively. For marital status, 86.5% were single. 13.5% were married, and 0% were others. For education level, the highest 63.3% degree. Diploma 17.2%. Secondary school which is 14.8%. Master which is 2.1%. Primary school and PhD have the same percentage which is 1.3%. Meanwhile, for occupation level, the largest percentage with 44.0% which is students compared to retired which the lowest with 0.3%. In between, employed part time is 27.3% and employed is 24.2%. The unemployed, which is next lowest with 4.2%. For income level, 45.8% of



the respondents gain salary below RM2000. 37.8% gain salary between RM2001-RM3000. 10.9% gain salary between RM 3001-RM4000. While only 5.5% gain salary above RM4000. This statistic represents the actual demographic consumer perception of food safety at casual dining restaurants in Kota Bharu, Kelantan.

Table 2: Descriptive Analysis

<b>Variables</b>	<b>N</b>	<b>Mean</b>	<b>Standard Deviation</b>
Food Quality	384	4.39	0.602
Service Quality	384	4.14	0.495
Restaurant Ambience (Casual Dining)	384	4.34	1.488
Consumers Perception of Food Safety	384	4.25	0.474

Table 2 displayed the total number of respondents, the mean and standard deviation of the independent and dependent variables, respectively. Food quality had the highest mean among the independent (4.39), followed by service quality (4.14), and restaurant ambience (4.34; casual dining). Furthermore, 4.25 was the dependent variable's mean.

Table 3: Reliability Analysis

<b>Variable</b>	<b>Number of Item</b>	<b>Cronbach's Alpha Coefficient</b>	<b>Strength of Association</b>
Food Quality	5	0.700	Moderate
Service Quality	5	0.730	Good

Restaurant Ambience (Casual Dining)	4	0.651	Moderate
Consumers Perception of Food Safety	4	0.704	Good

Table 3 demonstrates that the food quality Cronbach's Alpha coefficient was 0.700, indicating a moderate strength of association. The coefficient found for the questions relating to the food quality variable is thus valid. Second, there is a good strength of association between service quality and the Cronbach's Alpha coefficient of 0.730. The coefficient found for the questions relating to the service quality variable is valid. Thirdly, the Cronbach's Alpha coefficient of restaurant ambience (casual dining) is 0.651 which resulted as moderate strength of association. Thus, the coefficient obtained for the questions of the restaurant ambience (casual dining) variable is valid. Finally, four questions were employed in this study to assess the consumer perception of food safety. With a Cronbach's Alpha coefficient of 0.704 and a good strength of association, consumers' perceptions of food safety are generally positive. The coefficient found for the consumer perception of food safety variable questions is therefore valid.

Table 4: Pearson Correlation Analysis

Variable		R- Value	N	Level
Food Quality	Pearson Correlation	0.416	384	Moderate
Service Quality	Pearson Correlation	0.643	384	Moderate
Restaurant Ambience (Casual Dining)	Pearson Correlation	0.561	384	Moderate

This research aims to identify relationships between the independent variables (food quality, service quality, and restaurant ambience) and the dependent variables (consumers' perception of food safety). Table 4 displays the significant value, number of responses which is 384, and Pearson correlation coefficient. The p-value was 0.000, which was below than the significance

threshold of 0.01. The association between food quality and consumer perceptions of food safety is moderate, with a correlation value of 0.416. The p-value was 0.000, which was below than the significance threshold of 0.01. A moderate association between service quality and consumers' perceptions of food safety was suggested by the correlation value of 0.643. The p-value was 0.000, below the threshold of significance of 0.01. The moderate association between restaurant ambience (casual dining) and consumers perceptions of food safety was shown by the correlation coefficient of 0.561.

## **DISCUSSION AND RECOMMENDATION**

According to the findings, relationship between food quality and consumers perception is moderate ( $r=0.416$ ,  $n=384$ ,  $p<0.01$ ). As a result, food quality plays an important role in consumer perception of food safety at restaurants in Kota Bharu, Kelantan. A study conducted in a restaurant in Spain demonstrates that the people agree that food quality is the most crucial factor in ensuring the safety of food for consumers (Authors, 2012). Second, the finding shows a moderate significant relationship ( $r=0.643$ ,  $n=384$ ,  $p 0.01$ ) between the service quality and consumers perception of food safety in Kota Bharu, Kelantan. In influencing consumer purchase decisions, service quality is a major factor. This is reinforced by a study conducted in an eating area on the island of Mauritius, which found that consumers in Mauritius value this component of service quality more than others, making it the primary factor in determining whether or not they are satisfied with their purchases (Ramseook-Munhurrin, 2012).

The results also show a moderate significant correlation ( $r=0.561$ ,  $n=384$ ,  $p 0.01$ ) between restaurant ambience (casual dining) and consumers' perceptions of food safety. The ambience of a restaurant is crucial to creating a positive first impression and luring diners into impression (Mehrabian et al., 1974). An international study that supports restaurant ambience was conducted in a restaurant in Hong Kong and states that the restaurant's marketing strategies depend not only on the quality and style of the food but also on other attributes like the restaurant ambience created by that restaurant (Chow et al., 2007). This is supported by the fact that the restaurant's marketing strategies depend on these other attributes as well. Based on the results of the data analysis and the preceding case study, it can be said that all the independent variables in Kota Bharu, Kelantan, have a moderate impact on consumers' perceptions of food safety, but the service quality has the greatest impact.

In this study also has its own limitations. The first limitation that had been discovered was the lack of study in this especially in Kota Bharu, Kelantan. Even though there were a lot of restaurants that had been open, it was still hard for this research to be conducted. It was hard for the researcher to collect the data and not all of them were concerned about answering the questionnaire.

In any researcher has their own limitations. Therefore, this study is essential for continuation in future research. The findings reveal that the

independent variable which is service quality was one of the most reasons the respondent goes to the restaurant. Therefore, it is recommended the theoretical for the restaurant to improve the service quality to attract more customers. Furthermore, it is recommended methodologies for future researchers to conduct a systematic review to identify and evaluate the methodological tactics utilized in training programs. Additionally, it is also recommended the practical for the future researchers to develop a safe food handling which is include maintaining personnel cleanliness, preventing cross-contamination, heating the food properly, maintaining food at proper temperature and avoiding consumption of risky food.

## CONCLUSION

The purpose of this study is to find out about consumers perception of food safety in Kota Bharu, Kelantan and to see if these variables (food quality, service quality and restaurant ambience) can influence the consumers perception. This finding provides extension information to some antecedent predictions that related to consumer perception of food safety in restaurants. Considering this finding, all independent factors have a marginal impact on the dependent variable, with service quality having the largest impact. To secure the long-term viability of the food industry, knowledge is crucial in the decision-making process.

## REFERENCES

- Abdullah, S. M. (2022). "Kelantan Logs 64 Food Poisoning Cases." Retrieved 30 March 2023, from <https://www.nst.com.my/news/nation/2022/04/786161/kelantan-logs-64-food-poisoning-cases>.
- Akter, M., Sadekin, M. N., & Patwary, A. K. (2020). An Empirical Study on Students' Satisfaction from Mawlana Bhashani Science & Technology University, Bangladesh. *Review of Economics and Development Studies*, 6(2), 363-379.
- Alom, S., Patwary, A. K., & Khan, M. M. H. (2019). Factors affecting the turnover intention of Bangladeshi migrants in the United Arab Emirates: An empirical study on the hotel industry. *International Journal of Innovation, Creativity and Change*, 8(3), 344-360.
- Authors, F. (2012). Customers' Expectations Factors in Restaurants the Situation in Spain. <https://doi.org/10.1108/02656710210438122>
- Boslaugh, Sarah, Watters, Paul Andrew, Dr. (2008). *Statistics in a Nutshell: A Dekstop Quick Reference (In a Nutshell (O'Reilly))*.
- Chang, M.L.D.; Suki, N.M.; Nalini, A. (2014). A Structural Approach to Students' Satisfaction Level with University Cafeteria. *Asian Soc. Sci.* 10, 202–209.
- Chow, I. H., Lau, V. P., & Lo, T. W. (2007). Service Quality in Restaurant Operations in China: Decision- and Experiential-Oriented Perspectives. 26, 698–710. <https://doi.org/10.1016/j.ijhm.2006.07.001>
- Collins, J. E. (1997). Impact of Changing Consumer Lifestyles on the Emergence/Reemergence of Food Pathogens. *Emerging Infectious*

- Diseases, 3(4), 471–479. <https://doi.org/10.3201/eid0304.970409>
- Fatin, N., Rasol, S. M., Mohd, R., Helmy, F., Ismail, R., & Rohiat, A. (2021). Customers' Perception on Food Hygiene and Safety at Pasar Siti Khadijah, Kota Bharu. *I(2)*, 210–217. <http://publisher.uthm.edu.my/periodicals/index.php/ritvet>
- Fengmin, Z., Baijun, W., Jiangtao, B., Li, L., & Patwary, A. K. (2022). Investigating revisit intention of medical tourists in China through nutritional knowledge, perceived medical quality, and trust in the physiologist: A recommendation on health tourism policy measures. *Frontiers in Public Health*, 10, 893497.
- Ha, J., & Jang, S.C. (2010). Effects of Service Quality and Food Quality: The Moderating Role of Atmosphere in an Ethnic Restaurant Segment. *International Journal of Hospitality Management*, 29, 520-529.
- Hazbar, A. M. H., Alem Mohammed, A., & Karim, A. K. A. (2019). An Empirical Study of Factors Influencing hotel customers' online booking Intention. *مجلة العلوم التربوية و الدراسات الإنسانية*, (5), 1-17.
- Heung, V. C., & Gu, T. (2012). Influence of Restaurant Atmospherics on Patron Satisfaction and Behavioral Intentions. *International Journal of Hospitality Management*, 31(4), 1167-1177. <https://doi.org/10.1016/j.ijhm.2012.02.004>
- Huang, Y.-b., Lan, Y.-b., & Lacey, R. (2004). Artificial Senses for Characterization of Food Quality. *Journal of Bionic Engineering*, 1(4), 159-173. <https://doi.org/10.1007/BF03399472>
- Jalil, Amily Fikry, Anizah Zainuddin. (2016). The Impact of Store Atmospherics, Perceived Value, and Customer Satisfaction on Behavioural Intention, *Procedia Economics and Finance*, 37, 538-544. [https://doi.org/10.1016/S2212-5671\(16\)30162-9](https://doi.org/10.1016/S2212-5671(16)30162-9).
- Kement, Ü., Çavuşoğlu, S., Bükey, A., Göral, M., & Uslu, A. (2021). Investigation of the Effect of Restaurant Atmosphere on Behavioral Intention. *Journal of Tourism and Services. Journal of Tourism and Services*, 12(22), 222-242. <https://doi.org/10.29036/jots.v12i22.245>
- Kotler, P., & Armstrong, G. (2011). *Principles of Marketing* (14. rd. ed.). New Jersey: Prentice Hall
- Krejcie, R.V. and Morgan, D.W. (1970) Determining Sample Size for Research Activities. *Educational and Psychological Measurement*, 30, 607-610.
- Li, L., Ragavan, N. A., Patwary, A. K., & Baijun, W. (2022). Measuring patients' satisfaction toward health tourism in Malaysia through hospital environment, nutritional advice, and perceived value: A study on Chinese exchange students. *Frontiers in public health*, 10, 893439.
- Li, L., Wu, B., & Patwary, A. K. (2022). How marine tourism promote financial development in sustainable economy: new evidences from South Asia and implications to future tourism students. *Environmental Science and Pollution Research*, 29, 1155-1172.
- Li, L., Wu, B., & Patwary, A. K. (2022). The psychosocial factors affecting chinese Outbound Exchange and mobility students' academic performance during COVID-19. *Frontiers in psychology*, 13, 872516.

- Lim, H. (2010). Understanding American Customer Perceptions on Japanese Food and Services in the U.S Part of the Food and Beverage Management Commons, and the Marketing Commons. <https://digitalscholarship.unlv.edu/thesesdissertations/654%>
- Mehrabian, Albert and R. James. (1974). An Approach to Environment Psychology.
- Mohi, Z. B. (2012). An Analysis of Restaurant Patrons' Experiences in Malaysia: a Comprehensive Hierarchical Modelling Approach [PhD Thesis, Lincoln University]. <http://dspace.lincoln.ac.nz/bitstream/handle/10182/4996/>
- Namkung, Y. & Jang, S., (2007). Does Food Quality Really Matter in Restaurants? Its Impact on Customer Satisfaction and Behavioral Intentions. *Journal of Hospitality and Tourism Research*, 31 (3), 387-409.
- Omar, S., Ariffin, H. F., & Ahmad, R. (2015). The Relationship between Restaurant Ambience and Customers' Satisfaction in Shah Alam Arabic Restaurants, Selangor. *International Journal of Administration and Governance*, 1(4), 1–8.
- Parasuraman, A., Zeithaml, V. A., & Berry, L. (1988). SERVQUAL: A Multiple-Item Scale
- Parasuraman, A., Zeithaml, V. A., & Berry, L. L. (1985). A Conceptual Model of Service
- Patwary, A. K., Roy, B., Hoque, R., & Khandakar, M. S. A. (2019). Process of developing a community based tourism and identifying its economic and social impacts: An Empirical study on Cox's Bazar, Bangladesh. *Pakistan Journal of Humanities and Social Sciences*, 7(1), 1-13.
- Ramseook-Munhurrun, P. (2012). Perceived Service Quality in Restaurant. 5(3), 1–14.
- Shaharudin, M. R., Ismail, A. S. B., Mansor, S. W., Elias, S. J., Jalil, M. A., & Omar, M. W. (2011). Innovative Food and its Effects toward Consumers' Purchase Intention of Fast-Food Product. *Canadian Social Science*, 7(1), 110-118. <https://doi.org/10.3968/j.css.1923669720110701.011>
- Steven Nickolas. (2021). Correlation Coefficients: Positive, Negative, Zero. <https://www.investopedia.com/ask/answers/032515/what-does-it-mean-if-correlation-coefficient-positive-negative-or-zero.asp>
- Stroebele, N., & De Castro, J. M. (2004). Effect of Ambience on Food Intake and Food Choice. *Nutrition*, 20(9), 821-838. <https://doi.org/10.1016/j.nut.2004.05.012>
- Sukhatme, P. V. (2008). Sampling Theory of Surveys with Applications. Indian Society of Agricultural Statistics, New Delhi, India and the Iowa State University Press, Ames, Iowa, U.S.A.
- Sulek, J. M., & Hensley, R. L. (2004). The Relative Importance of Food, Atmosphere, and Fairness of Wait: The Case of a Full-Service Restaurant. *Cornell Hotel and Restaurant Administration Quarterly*,

- 45, 235-247. <https://doi.org/10.1177/0010880404265345>
- Sumethokula, P., Patwary, A. K., Srinuanpanc, B., Srinuanpand, C., Suwandee, P., Thammathikulf, A., & Phanong, W. (2020). The potential of new tour repackaging for creative tourism among entrepreneurs in Nakhon Si Thammarat. *International Journal of Innovation, Creativity and Change*, 13(10), 1752-1771.
- Wu, B., Liu, S., Wang, J., Tahir, S., & Patwary, A. K. (2021). Assessing the mechanism of energy efficiency and energy poverty alleviation based on environmental regulation policy measures. *Environmental Science and Pollution Research*, 28, 40858-40870.
- Wu, B., Zhai, B., Mu, H., Peng, X., Wang, C., & Patwary, A. K. (2021). Evaluating an economic application of renewable generated hydrogen: A way forward for green economic performance and policy measures. *Environmental Science and Pollution Research*, 1-15.
- Wu, H.-C., & Mohi, Z. (2015). Assessment of Service Quality in the Fast-Food Restaurant. *Journal of Foodservice Business Research*, 18(4), 358-388. <https://doi.org/10.1080/15378020.2015.1068673>

# CONSUMER KNOWLEDGE, PERCEPTION OF FOOD IMAGE AND ACCEPTANCE TOWARDS KELANTAN TRADITIONAL FOOD

*SHATHEES A/L MANIAM (H20A1752), ROSYAZLEEN BINTI RAHIM (H20A1737),  
ROSZIEANA AZWATI BINTI MOHD LUDIN (H20A1738), SHARIFAH NUR AFIQAH  
BINTI SY.MD.ZARRUL AZMY (H20A1749) & \* MR. ABDULLAH BIN MUHAMED  
YUSOFF*

*Faculty of Hospitality, Tourism and Wellness, Universiti Malaysia Kelantan*

*Corresponding email: Abdullah@umk.edu.my*

---

## ABSTRACT

---

Universiti Malaysia Kelantan gave us the opportunity to conduct research, which satisfies a subject requirement for the Bachelor of Entrepreneurship (Hospitality). Our manager, Mr. Abdullah Bin Muhamed Yusoff, and everyone in our group collaborated to complete the research, and our family was our biggest asset. The data collection has been done through a structured questionnaire and analyzed with SPSS data analysis software.

---

**Keywords: Consumer Knowledge, Perception of Food Image, Acceptance, Traditional Food**

---

## INTRODUCTION

Food-related consumer behavior is influenced by personal, cultural, and religious values, and is seen as a symbol of social personality. Malaysia is a multicultural and multiracial country, with over half of the population being Malay. By presenting regional cuisine, it helps to preserve dishes' heritage. Malay cultures adhere to traditional cultural customs, and food neophobia is the inability to ingest or reject novel foods. Fear of having inferior taste may also be related to psychological resistance to change, which has an impact on food availability. Traditional foods are food varieties



enjoyed over a long period of time and by many generations. By preserving cultural legacy, traditional food knowledge transfer (TFKT) could bolster national integrity. Our senses are roused by food, from the flavor to the aroma, presentation, sensation, and crunch. Food follows us everywhere we go, and our memories and digestive systems are affected by our lives. The human senses of taste and smell are intertwined. Traditional food knowledge is the sharing of information, expertise, and culinary skills among family members. Cultural awareness has a big impact on a community's quality of life by boosting a sense of identity, fostering positive relationships, and fostering a stable, peaceful environment. Food literacy is essential to maintaining the unique identity of our food heritage. Perception is the process through which people identify and interpret sensory stimuli. Customers who consumed traditional food in this study were the ones who determined how people perceived the dish's image. Karim and Chi (2010) and Chi et al. (2013) have produced research in this specific area. Malaysian cuisine is varied and influenced by culture, values, and beliefs. Consumers favor high-quality food and are taught about nutrition from a young age. Information about traditional foods is passed down from generation to generation.

There are three objectives in this research:

1. To determine the consumer knowledge towards Kelantan traditional food image.
2. To identify the consumer perception towards Kelantan traditional food image.
3. To analyze the consumer acceptance of Kelantan traditional food image.

## **SIGNIFICANCE OF STUDY**

This study aimed to understand the customer knowledge, food image perceptions and acceptance of traditional Kelantan food. This study provided all communities with useful knowledge of how important traditional food is in each state, as the uniqueness of traditional foods differs from other states. Consumers have learned more about the uniqueness of Kelantan's traditional food. They also learn about introducing food to taste, use of ingredients and how to cook it. This consumer has been known and has an attempt to try the food even if it is not their normal food. Next, the results of this study have helped universities improve their literature on expected outcomes. It helps consumers learn more about traditional foods in terms of taste, types of foods,

cooking methods, etc. This is because different states have different tastes and peculiarities of food. Finally, the study has also informed other researchers on the taste, novelty and consumer attitudes of traditional foods. The results of this study are of particular interest to researchers studying the traditional foods of Kelantan.

## **LITERATURE REVIEW**

### **PERCEPTION OF TRADITIONAL FOOD**

Perceptions characterized as the interaction by which consumers perceive and decipher tangible upgrades. The picture of Kelantan is as yet that of an eco the travel industry objective, not standing endeavors to elevate and draw in individuals to visit Kelantan to advance social the travel industry, including food the travel industry. The perception of traditional food picture not entirely settled by purchasers who devoured food legacy in this review. These consumers perceptions were connected to both worth and quality. Basically, consumers have been more disposed to buy and devour food that is great, solid, and protected to eat. Consumers are more positive about purchasing and devouring solid and great foods. Therefore, the food picture is basically attempting buyers to eat the food.

### **ACCEPTANCE OF TRADITIONAL FOOD**

Malaysia's traditional foods reflect its rich culture, and Kelantan's food is better than Terengganu's. Traditional food data is passed down from one age to another, and past feast encounters familiarize consumers with the food available at an objective. Health conscious consumers are changing their purchasing propensities and looking for items with medical advantages.

### **KNOWLEDGE OF TRADITIONAL FOOD**

The capacity to understand consumer conduct, for example, data search was basic. Information additionally impacts food inclinations on the grounds that social qualities impact information. Traditional food information as trading information, experience, and food abilities between relatives. Traditional food instruction should start from adolescence and go on over the course of life, as it has a critical connection between generations and food legacy. It helps

consumers learn and arrange their social distinctions, and is essential in safeguarding our food's traditional character.

## **KELANTAN TRADITIONAL FOOD**

Kelantan is known as the "Cradle of Malay Culture," on account of its unmistakable social traditional, indigenous habitats, the unmatched neighborliness of local people, as well as its unique foods, all of which impact the state's travel industry improvement. Among popular dishes in Kelantan, for example, are Nasi Kerabu, Laksam Kelantan, Ayam Percik, Kerabu Sare, Kuih Akok, Bahulu, and many others. Besides, a few foods have been assigned as legacy foods by the Jabatan Warisan Negara gateway, including Nasi Kerabu, Nasi Tumpang, Kuih Lompat.

### **Research Hypothesis**

Three hypothesis have been tested in this study, namely:

1. H1: There is a significant relationship between consumer acceptance and traditional food image among consumers in Kota Bharu.
2. H2: There is a significant between relationship between consumer perception and traditional food image among consumer
3. H3: There is significant between consumer knowledge and traditional food image among consumer in Kota Bharu

### **Research Framework**

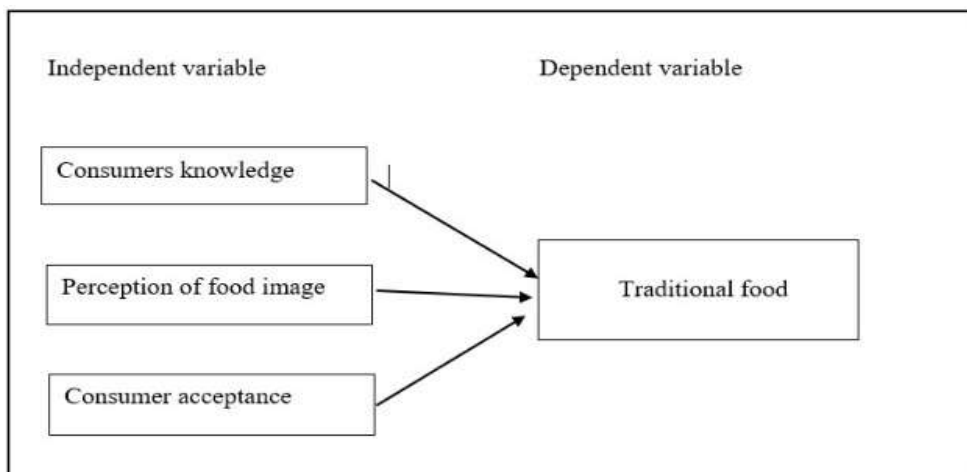

Figure 1: Consumer knowledge, perception of food image and acceptance towards Kelantan Traditional food

The conceptual framework of the study. This conceptual framework presents the independent variables (IV) and dependent variables (DV) of this study. The independent variables were consumer knowledge, perceptions and acceptance of Kelantan traditional foods. On the other hand, the dependent variable (DV) is traditional food. There are three independent variables (IV): consumer knowledge, food image perception, and consumer acceptance, and the dependent variable (DV) is the ratio of Kelantan traditional food to consumers.

## **METHODOLOGY**

Research technique is defined as a highly intelligent movement used to examine nature and matter that controls how information is obtained, analysed, and described (Hernandez, Rangel, & Arandia, 2016). This study aims to better understand consumer knowledge, culinary perception, and acceptability of traditional foods from Kelantan. It is the study of using unbiased and accurate analysis to find solutions to scientific and societal problems. This chapter will address the study's research design, target population, sample size, sampling strategy, data collecting, research instrument, data analysis, and chapter summary.

### **Research Design**

This study design has been carried out to give researchers the proper recommendations for achieving the research objectives or testing the made hypothesis. It is important to certify that the sources used to collect the data are capable of fully answering the study questions. Quantitative research approaches collect data in numerical form and analyze it using mathematical structures, particularly statistics, to shed light on a problem or phenomenon. Quantitative mining uses research methods and uses numeric models as an information retrieval system.

### **Data Collection**

Primary data is gathered from real resources, such as users or other respondents, on the people who make up the target audience for the given review. Data collecting methods include using surveys, one-on-one meetings, Google forms, and review techniques to collect data. In the

interim, all secondary data can be checked from public sources or internal documents, such as books, papers, magazines, and so forth. In addition, it is possible to use review forms, Google forms, and questionnaires for secondary data collecting. This study uses a questionnaire as its primary method of data collection. The researcher used the web (online platform) to adapt the questionnaire and for the data gathering method.

## Sampling

Population Size	Variance of the population P=50%					
	Confidence level=95% Margin of error			Confidence level=99% Margin of error		
	5	3	1	5	3	1
50	44	48	50	46	49	50
75	63	70	74	67	72	75
100	79	91	99	87	95	99
150	108	132	148	122	139	149
200	132	168	196	154	180	198
250	151	203	244	181	220	246
300	168	234	291	206	258	295
400	196	291	384	249	328	391
500	217	340	475	285	393	485
600	234	384	565	314	452	579
700	248	423	652	340	507	672
800	260	457	738	362	557	763
1000	278	516	906	398	647	943
1500	306	624	1297	459	825	1375
2000	322	696	1655	497	957	1784
3000	341	787	2286	541	1138	2539
5000	357	879	3288	583	1342	3838
10000	370	964	4899	620	1550	6228
25000	378	1023	6939	643	1709	9944
50000	381	1045	8057	652	1770	12413
100000	383	1056	8762	656	1802	14172
250000	384	1063	9249	659	1821	15489
500000	384	1065	9423	660	1828	15984
1000000	384	1066	9513	660	1831	16244

The researcher is applying the convenience sampling for this study to select respondents for this survey. Convenience sampling is a non-probability sampling technique in which subjects are chosen based on their ease of access and proximity to the researcher. Using this sampling technique, every person in the selected areas of Kelantan had a chance to be chosen for this study. This type of sampling made it easier for the researcher to collect data, and the data was more reliable. This study's data was gathered from respondents in three different areas of Kelantan. The data was gathered using a questionnaire form. During the sampling procedure, the researcher stayed near the respondents to ask if they had any queries about the questionnaire. The respondent must be familiar with Kelantan's traditional food.

## Data Analysis

This survey is analyzed by the Social Science Statistics Package (SPSS) version 23.0. Reliability and validity tests are used in research to measure the strength of questionnaires. Descriptive analysis helps measure the results of this study and answer the research objectives and research questions for which hypothesis testing is performed in this study.

Descriptive tests were used to determine consumers' level of knowledge of Kelantan food heritage, perception of food images, and acceptance of Kelantan food heritage. The data obtained in this study were not normal after analysis by normality test. Users can make tables and pie charts using the program-based data processing and analysis windows known as SPSS. Researchers' use of computers helped them reduce the amount of time and effort needed to gather data and perform quantitative analysis swiftly and simply. To assess quantitative data, the researcher uses Pearson's Correlation, regression, the descriptive statistic, reliability statistic, and more.

## FINDINGS

**Table 1: Demographic Analysis**

<b>Demographic</b>	<b>Categories</b>	<b>Frequency (N)</b>	<b>Percentage (%)</b>
<b>Gender</b>	<b>Male</b>	<b>239</b>	<b>59.8</b>
	<b>Female</b>	<b>163</b>	<b>40.3</b>
<b>Age</b>	<b>Under 20</b>	<b>39</b>	<b>9.7</b>
	<b>20-35</b>	<b>288</b>	<b>71.5</b>
	<b>36-50</b>	<b>68</b>	<b>15.9</b>
	<b>50-65</b>	<b>10</b>	<b>2.5</b>
	<b>Over 65</b>	<b>2</b>	<b>0.5</b>

<b>Race</b>	<b>Malay</b>	<b>222</b>	<b>55.1</b>
	<b>Chinese</b>	<b>43</b>	<b>10.7</b>
	<b>Indian</b>	<b>112</b>	<b>27.8</b>
	<b>Other</b>	<b>26</b>	<b>6.5</b>
<b>Level of Educations</b>	<b>SPM</b>	<b>47</b>	<b>11.7</b>
	<b>STPM</b>	<b>45</b>	<b>11.2</b>
	<b>DIPLOMA</b>	<b>54</b>	<b>13.4</b>
	<b>DEGREE</b>	<b>241</b>	<b>59.8</b>
	<b>MASTER/PHD</b>	<b>11</b>	<b>2.7</b>
	<b>OTHER</b>	<b>5</b>	<b>1.2</b>
<b>Working Status</b>	<b>Full Time</b>	<b>63</b>	<b>15.6</b>
	<b>Part Time</b>	<b>42</b>	<b>10.4</b>
	<b>Self Employed</b>	<b>49</b>	<b>12.2</b>
	<b>Student</b>	<b>249</b>	<b>61.8</b>
<b>Monthly Income</b>	<b>Below RM 1000</b>	<b>279</b>	<b>69.2</b>
	<b>RM 1000-RM 2999</b>	<b>77</b>	<b>19.1</b>
	<b>RM 3000- RM 4999</b>	<b>33</b>	<b>8.2</b>
	<b>ABOVE RM 5000</b>	<b>14</b>	<b>3.5</b>

Table 1 portrays the profile of the respondents. Out of 403 respondents, most of respondents were male which represented 59.8% of the complete example. As far as the respondents age, 9.7% were under 20 years of age, 71.5% were 20-35 years of age, 15.9% were 36-50 years of age, 2.5% were 50-65 years of age and 0.5% were north of 65 years of age. In the mean time, as far as race, the larger part were Malay which is 55.1% trailed by Indian which is

27.8%, Chinese which is 10.7%, and different races which is 6.5%. In terms of respondents by level of education, out of 11.7% were SPM, 11.2% were STPM, 13.4% were DIPLOMA, 59.8% where DEGREE is the highest level. 2.7% were MASTER/PHD, and 1.2% were others of education level. In terms of working status, 15.6% were Full time, 10.4% were Part time, 12.2% were Self employed and 61.8% is the highest working status by Student. In terms of monthly income, 69.2% is the highest by below RM1000, 19.1% were RM1000-RM2999, 8.2% were RM 3000-RM4999 and 3.5% were above RM5000. This statistics nearly represents the actual demographic consumer knowledge, perception of food image and acceptance towards Kelantan Traditional Food.

## **RESULT OF RELIABILITY TEST**

Reliability analysis was utilized to gauge the unwavering quality of the survey. The pilot test has been finished with 30 respondents before the poll was circulated to the 384 respondents through an internet based overview strategy.

**Table 2: Result of Reliability Test**

<b>Variables</b>	<b>Number of items</b>	<b>Cronbach's Alpha</b>
<b>Consumers knowledge</b>	<b>4</b>	<b>0.619</b>
<b>Perception of food image</b>	<b>4</b>	<b>0.859</b>
<b>Consumers acceptance</b>	<b>4</b>	<b>0.880</b>

Table above shows the general worth of Cronbach's Alpha for the autonomous and subordinate variable in this review. It shows the worth of the survey in the middle of between the



scope of low acknowledgment level (0.619) to extremely high acknowledgment level (0.880). A complete number of three free factors and one ward variable has been tried utilizing Cronbach's Alpha. The primary free factor is consumer knowledge viewed as in moderate stage (4 things;  $\alpha = 0.619$ ). In view of a review that has been finished by Williamson and Hassanli (2020), the examination results on consumer knowledge have viewed as in moderate strength connection ( $\alpha = 0.469$ ).

### **Pearson Correlation**

Pearson's Connection Coefficient is a technique to distinguish the force of affiliation and critical connection between the IVs, middle person, and DV. Pearson's relationship coefficient is the two factors that are partitioned by the result of their standard deviations. Finding the straight connection between two constant variables is utilized.

**Table 3: Pearson's Correlation Coefficient**

<b>SIZE OF CORRELATION</b>	<b>INTERPRETATION</b>
<b>0.90 to 1.0 (-0.90 to -1.0)</b>	<b>Very high positive (negative) correlation</b>
<b>0.70 to 0.90 (-0.70 to -0.90)</b>	<b>High positive (negative) correlation</b>
<b>0.50 to 0.70 (0.5 to -0.70)</b>	<b>Moderate positive (negative) correlation</b>
<b>0.30 to 0.50 (-0.30 to -0.50)</b>	<b>Low positive (negative) correlation</b>

0.00 to 0.30 (-0.0 to -0.30)	Little if any correlation
------------------------------	---------------------------

Source: Hinkle, Wiersma, & Jurs (2003).

**Table 4 : Results of Pearson Correlation Analysis.**

	Traditional Food	Consumers Knowledge	Perception of food image	Consumers Acceptance
Traditional Food	1			
Consumers Knowledge		1 0.569**		
Perception of food image			1 0.683**	
Consumers Acceptance				1 0.735* *

**\*\*Correlation is significant at the 0.01 level (2-tailed).**

By utilizing Pearson's Relationship examination, it likewise can test the multicollinearity issue between the factors. It typically happens when the connection between's IVs is high. Thus, to keep away from this issue, the coefficient worth shouldn't surpass 0.90. In the event that r is more prominent than 0.00 however under 1.00, there is a positive connection between two factors. The greater the number, the more grounded the relationship. It implies the greater the number can

get the better expectations. Because of the assessment of the strength of straight by utilizing a solitary number that falls inside the scope of  $\pm 1$ , Pearson Relationship was liked.

## **DISCUSSION & RECOMMENDATION**

This study discussed consumer knowledge, food image perception, and acceptance of traditional Kelantan food. All data was collected through an online survey using Google Forms, as this study is based on quantitative methods and is more practical in today's context. Google Forms were distributed to her 384 respondents to fill out the Google Forms and collect data for analysis. During the data collection process, researchers faced several challenges.

Most consumers are unaware of the special importance of traditional Malaysian food. Today, the majority of people are turning their attention to viral cuisine, which is growing in popularity. Fast food is preferred over traditional Malay food, especially in Kelantan. Some consumers ignore this Google Form because Malaysians do not know the value of preserving traditional foods. They are more focused on foods that are currently popular and include a variety of viral foods. Therefore, they do not care about the peculiarities of traditional foods, especially Kelantan. Examples of traditional Kelantan dishes include budu, kuih akok, nasi kerabu, and laksam.

The majority of today's young people are unaware of historical and traditional foods. It is due to lack of information about local Kelantan cuisine. They are reluctant to eat this traditional meal until they learn its specialties. Most of them can only appreciate the taste of traditional Kelantan food after trying it for themselves. Nevertheless, the researchers were able to gather his 384 respondents to complete the questionnaire.

Future studies may use this work as a guide and improvement. The study should be strengthened and more useful information should be obtained, according to several recommendations. The

investigation could be carried out utilizing qualitative techniques on certain of them. This will make it simpler for researchers to get information that is more precise and accurate. The respondents are more likely to provide a clear and accurate response during a structured face-to-face interview.

The researcher must next clearly identify the intended target respondent. The targeted target should correspond to the study's title since if the responder is familiar with the topic, it may be easier and faster to find relevant material. If the respondents are still unaware of the sophisticated nature of the study's topic, the researcher would be advised to select a suitable target responder for the study.

Additionally, initial measures include attempting to join active groups associated with the study's subject. In order to help with the search for accurate information, groups can be handed questionnaires and questions pertaining to the research topic can be posed in the 70 group. This is because group members are already aware of the study and could potentially assist in filling out the necessary information.

Finally, the researchers could take into account more factors for future research. The three variables that this study focuses on: customer acceptance, perception of food image and consumer knowledge have only a moderately positive connection with the dependent variables.

Future studies should use this work as a guide and improvement. Qualitative techniques should be used to obtain more precise and accurate information. Target responders should be familiar with the study's topic. Groups should be given questionnaires and questions pertaining to the research topic. Finally, more factors should be taken into account, such as customer acceptance, perception of food image and consumer knowledge.

## CONCLUSION

This chapter summarizes the findings of the previous analysis, focusing on the research objectives of determining consumer knowledge towards Kelantan traditional food, identifying consumer perception towards traditional food, and analyzing consumer acceptance of Kelantan traditional food. The study found a moderately positive correlation between consumer knowledge and traditional food in Kelantan, with knowledge influencing food preferences and exchanging knowledge about foods, experiences, and tastes. The perception of food image also showed a positive relationship with traditional food in Kelantan, with sensory evaluation being a crucial parameter. The study also answered the research questions of "What is the consumer perception toward Kelantan traditional food?" and "Does the Kelantan traditional food is accepted among the consumer?". The conclusion of the study is that the perception of Kelantan traditional food is positively correlated with consumer knowledge, perception of food image, and acceptance of traditional food.

## REFERENCES

- Akter, M., Sadekin, M. N., & Patwary, A. K. (2020). An Empirical Study on Students' Satisfaction from Mawlana Bhashani Science & Technology University, Bangladesh. *Review of Economics and Development Studies*, 6(2), 363-379.
- Al Mahmud, S. R. (2020). The effectiveness of Facebook advertisements on purchase intention of customers in Malaysia. *South Asian Journal of Social Sciences and Humanities*, 1(1), 97-104.
- Alimentarium, R. (2017, January 6). Food neophobia. Retrieved November 15, 2020, from <https://www.alimentarium.org/en/knowledge/food-neophobia-0>
- Alom, S., Patwary, A. K., & Khan, M. M. H. (2019). Factors affecting the turnover intention of Bangladeshi migrants in the United Arab Emirates: An empirical study on the hotel industry. *International Journal of Innovation, Creativity and Change*, 8(3), 344-360.
- Barker, L. M. (1982). 'Building memories for foods'. *The Psychobiology of Human Food Selection*. Westport, CT: AVI Publishing.
- Bertella, G. (2011). *Knowledge in Food Tourism: The Case of Lofoten and Maremma Toscana*. Westport, CT: AVI Publishing.
- Bowen, R. L. & Devine, C. D. (2011). Watching a person who knows how to cook, you'll learn a lot. Linked lives, cultural transmission and the food choices of Puerto Rican girls. *Journal of Appetite*, 56(2), 290-298.

- Dalilah, M. D. (2012). An Empirical Study On Innovative Traditional Food Products And Customer Acceptance Using Theory Planned Behavior. [Final year project report, Faculty of Technology Management and Technopreneurship, Universiti Teknikal Malaysia Melaka, Melaka].
- Darko Dimitrovski & Montserrat Crespi-Vallbona (2016): Role of food neophilia in food market tourists' motivational construct: The case of La Boqueria in Barcelona, Spain, *Journal of Travel & Tourism Marketing*, DOI:10.1080/10548408.2016.1193100
- Etikan, I., & Bala, K. (2017). Sampling and Sampling Methods. *Biometrics & Biostatistics International Journal*, 5(6).
- Fengmin, Z., Baijun, W., Jiangtao, B., Li, L., & Patwary, A. K. (2022). Investigating revisit intention of medical tourists in China through nutritional knowledge, perceived medical quality, and trust in the physiologist: A recommendation on health tourism policy measures. *Frontiers in Public Health*, 10, 893497.
- Hamzah, H., Karim, M. S. A., Othman, M., Hamzah, A. & Muhammad, N. H. (2015). Challenges in sustaining the Malay traditional kuih among youth. *International of Social Science and Humanity*, 5(5), 472-478.
- Hazbar, A. M. H., Alem Mohammed, A., & Karim, A. K. A. (2019). An Empirical Study of Factors Influencing hotel customers' online booking Intention. *مجلة العلوم التربوية و الدراسات الإنسانية*, (5), 1-17.
- Huh, J. (2002). Tourist Satisfaction with Cultural / Heritage Sites: The Virginia Historic Triangle. [Final year project report, Faculty of the Virginia Polytechnic Institute and State University, Blacksburg, Virginia].
- Karim, M. & Chi, C. (2010). Culinary tourism as destination attraction: An empirical examination of destinations' food image. *Journal of Hospitality Marketing & Management*, 19(6), 531-555.
- Kokkoris, M. D., & Stavrova, O. (2021). Meaning of food and consumer eating behaviors. *Food Quality and Preference*, 94, 104343.
- Li, L., Ragavan, N. A., Patwary, A. K., & Baijun, W. (2022). Measuring patients' satisfaction toward health tourism in Malaysia through hospital environment, nutritional advice, and perceived value: A study on Chinese exchange students. *Frontiers in public health*, 10, 893439.
- Li, L., Wu, B., & Patwary, A. K. (2022). How marine tourism promote financial development in sustainable economy: new evidences from South Asia and implications to future tourism students. *Environmental Science and Pollution Research*, 29, 1155-1172.

- Li, L., Wu, B., & Patwary, A. K. (2022). The psychosocial factors affecting chinese Outbound Exchange and mobility students' academic performance during COVID-19. *Frontiers in psychology*, 13, 872516.
- Md. Nor, N., Md. Sharif, M. S., Mohd. Zahari, M. S., Mohd. Salleh, H., Ishak, N. & Muhammad, R. (2012). The transmission modes of Malay traditional food knowledge within generations. *Journal of Social and Behavioural Sciences*, 50, 79-88.
- Nelson, V. 2016. Food and image on the official visitors site of Houston, Texas. *Journal of Destination Marketing and Management*, 5, 231-238.
- Nor, N. M., Sharif, M. S. M., Zahari, M. S. M., Salleh, H. M., Isha, N., & Muhammad, R. (2012). The transmission modes of Malay traditional food knowledge within generations. *Procedia-Social and Behavioral Sciences*, 50, 79-88.
- Omar, S., Ab Karim, S. & Omar, S. (2015). Exploring international tourists attitudes and perceptions: in characterizing Malaysian Heritage Food (MHF) as a tourism attraction in Malaysia. *International Journal of Social Science and Humanity*, 5, 474-489.
- Patwary, A. K., Roy, B., Hoque, R., & Khandakar, M. S. A. (2019). Process of developing a community based tourism and identifying its economic and social impacts: An Empirical study on Cox's Bazar, Bangladesh. *Pakistan Journal of Humanities and Social Sciences*, 7(1), 1-13.
- Perry, M. S. (2017). Feasting on Culture and Identity: Food Functions in a Multicultural and Transcultural Malaysia. *The Southeast Asian Journal of English Language Studies*, 23(4), 184-199. <http://doi.org/10.17576/3L-2017-2304-14>
- Pliner, P., & Hobden, K. (1992), "Development of a scale to measure the trait of food neophobia in humans", *Appetite*, Vol. 19 No. 2, pp. 105-20.
- Raji, M. N. A., Karim, S. A., Ishak, F. A. C., & Arshad, M. M. (2017). Past and present practices of the Malay food heritage and culture in Malaysia. *Ethnic Foods*, 4(4), 221-231.
- Ramli, M. A., Zahari, M. S. M., Halim, N. A. & Aris, M. H. M. (2016). The knowledge of food heritage identity in Klang Valley, Malaysia. *Procedia Social and Behavioral Sciences*, 105, 518-527. Sawe, B. E. (2019). Ethnic groups of Malaysia. Retrieved from <https://www.worldatlas.com/articles/ethnic-groups-of-malaysia.html>
- Saad, M., Kamarizzaman, N. A., Ishak, N. & Pratt, T. J. (2021). The influence of Pahang heritage food on behavioral intentions among Malaysian domestic tourists. *EnvironmentBehaviour Proceedings Journal*, 6(16), 163-169.
- Schacter, D. (2011). *Psychology*. Fifth Avenue New York: Worth Publishers.

- Sharif, M. S., Supardi, A., Ishak, N. & Ahmad, R. (2008). Malaysian Food as Tourist Attraction Paper presented at The 1st Malaysian Gastronomic - Tourism Conference.
- Steinmetz, R. (2010). Food, tourism and destination differentiation: The case of Rotorua, PhD Thesis, Auckland University of Technology, New Zealand
- Sumethokula, P., Patwary, A. K., Srinuanpanc, B., Srinuanpand, C., Suwandee, P., Thammathikul, A., & Phanong, W. (2020). The potential of new tour repackaging for creative tourism among entrepreneurs in Nakhon Si Thammarat. *International Journal of Innovation, Creativity and Change*, 13(10), 1752-1771.
- Taherdoost, H. (2016). Sampling Methods in Research Methodology; How to Choose a Sampling Technique for Research. *Academic Research in Management (IJARM)*, 5(2), 18-27.
- Vanhonacker, F., Kühne, B., Gellynck, X., Guerrero, L., Hersleth, M., & Verbeke, W. (2013). Innovations in traditional foods: Impact on perceived traditional character and consumer acceptance. *Food research international*, 54(2), 1828-1835.
- Wim Verbeke, & Lopez, G. P. (2005). Ethnic food attitude and behaviour among Belgians and Hispanics living in Belgium. *British Food*, 107(11), 823-840
- Wu, B., Liu, S., Wang, J., Tahir, S., & Patwary, A. K. (2021). Assessing the mechanism of energy efficiency and energy poverty alleviation based on environmental regulation policy measures. *Environmental Science and Pollution Research*, 28, 40858-40870.
- Wu, B., Zhai, B., Mu, H., Peng, X., Wang, C., & Patwary, A. K. (2021). Evaluating an economic application of renewable generated hydrogen: A way forward for green economic performance and policy measures. *Environmental Science and Pollution Research*, 1-15.
- Zhang, T., Chen, J., & Hu, B. (2019). Authenticity, quality, and loyalty: Local food and sustainable tourism experience. *Sustainability*, 11 (12), 3437.
- Zubaidah, S., & Arsih, F. (2021, March). Indonesian culture as a means to study science. *AIP Conference Proceedings*, 2330(1), 030037).



# FACTOR INFLUENCING CUSTOMER SATISFACTION AMONG MILLENNIALS TOWARD HOMETGROWN CAFE IN KOTA BHARU

*Shaza Shahirah, Siti Ainsyah, Siti Mas Ayuni & Siti Nabihah*

*Faculty of Hospitality, Tourism, and Wellness, Universiti Malaysia Kelantan*

*Corresponding email:abdullah.my@umk.edu.my*

---

## ABSTRACT

---

A cafe is considered a "third space" in urban life, distinct from work and home, offering a location for individuals to socialize, unwind, and form relationships. However, as coffee shops become more prevalent in metropolitan areas, they are increasingly playing a more comprehensive range of responsibilities and serving as places of business and pleasure, providing social spaces where people may connect and form communities. This study aims to look at the effect of the physical environment, fair pricing, and service quality on millennial customer satisfaction. This study was conducted at a homegrown café in Kota Bharu, Kelantan. Data for this study was gathered online via a Google form. The data gathered from this study was analysed using SPSS software version 26. This study analysis carried out for this study. By using descriptive analysis, reliability testing, and Pearson correlation. The finding of this research showed that all the hypothesis is accepted.

**Keywords:** Homegrown café, service quality, fair price, physical environment, customer satisfaction

---

## INTRODUCTION

Restaurants are establishments where food is made and provided to patrons. Additionally, the food service facility comprises the location where individual portions are served, whether consumption takes place on or off the premises, and where food is made and intended for individual portion service. A cafe is a small business that offers drinks as well as small meals or snacks. Cafe is a charming establishment that offers quick service and simple cuisine (Andrews, 2009). Nowadays, there is a rapidly expanding interest in and demand for cafes from various groups, including businesses holding meetings, families enjoying valuable time together, and the millennium generation, particularly university students working on assignments and participating in group discussions. In the present, a cafe is seen as a welcoming environment for people to meet and socialize as well as a place that sells hot drinks, snacks, and meals.

At the moment, the millennial generation determines customer volume. According to Kueh and Boo (2009), young adults regularly eat out and order takeaways, making millennials the key target in the food service industry (Gale, 2007; Hume, 2007). Furthermore, millennials have shown to be more adventurous when it comes to trying new foods and restaurants. Millennials tend to be more neophile than previous generations, as well as searching for goods and services that could satisfy their demands (Gale, 2007; Hume, 2007). Moreover, due to the technology-driven society of millennials, they tend to rely heavily on digital information for reviews of restaurants and food items (Kueh and Boo, 2009). As a result, they are likely to be influenced by the content published online and the recommendations of their peerpublished online and their peers when deciding where to dine or what food items to purchase. Therefore, restaurant owners and food companies restaurant owners and food companies need to keep up with the latest trends and technologiesto ensure that their products and services remain

attractive to millennials. In this sense, the locally owned cafe in Kota Bharu pays closer attention to customer satisfaction to build strong customer loyalty.

This study investigates the factor influencing millennials' customer satisfaction toward homegrown cafes in Kota Bharu. This research has targeted millennials who have already come homegrown at Kota Bharu. This research precisely aimed at the responses from millennials about their customer satisfaction at Kota Bharu.

Hence, there are three (3) objectives to investigate the customer satisfaction towards homegrown café among the millennial generation.

1. To examine the physical environment of the Homegrown Café at Kota Bharu, Kelantan affecting customer satisfaction.
2. To examine the relationship between satisfaction service quality toward customer satisfaction
3. To examine the relationship between satisfaction fair price toward customer satisfaction.

### **Significance of the Study**

#### **Customer**

As a customer, they need satisfaction toward the food and beverage establishment. Hence, this study can help the customer to become more alert about eating food and concerned about the condition of the dining area and its environment.

#### **Foodservice**

Cafés offer various services and matters, affecting patrons' preferences and actions differently. The story of the café, including its lower, middle, and upscale parts, may impact several aspects of young people's intentions.

#### **Future researcher**

This study can help the future researcher in comprehending and overcoming the challenges that patrons of food and beverage (F&B) enterprises will confront. They can utilise it as important information as well. As a result, the client may appreciate the value of food, which can also help them appreciate the significance of understanding food quality. Additionally, anyone who desire to launch a food and beverage business will benefit from this study's expertise and recommendations. This research compares cultural variations in consumer intents, values, reasons, and may also include other areas.

## **LITERATURE REVIEW**

### **Physical environmental**

To make structures more environmentally friendly the physical environmental variables have always been significant in building design (Esin & Yüksek, 2008). Despite countless research on how the physical environment of contemporary commercial places influences consumers' perceptual-behavioral performance, it is still a crucial issue (Sun & Yazdanifard, 2015; Yldrm et al., 2020a, 2020b; Wang et al., 2020). According to a study by Yldrm et al. (2019), customer behaviour and perceptual evaluations are directly correlated. This study is study demonstrates the significance of purposeful design employing proper space design concepts demonstrates the significance of purposeful design employing proper space

design concepts. Studies by Mihi et al. (2018), Sun and Yazdanifard (2015), and Yldrm et al. (2015) have found that when the physical environmental characteristics of interior spaces are regarded and valued favourably, individuals may stay in the same place for a longer time. The study by Wang et al. (2020) also focused on a number of physical environmental aspects, including the size and form of the space, the colour, materials, and texture utilised, as well as their impact on people's behaviours and the level of their physical, emotional, and mental well-being.

### **Service quality**

According to a recent study, there is a link between satisfied customers and high-quality services. Orel and Kara (2014) looked into the effect of Turkish customers' loyalty to a supermarket chain in addition to the discussion highlighted above. We utilised functionality, fun, security/privacy, assurance, design, simplicity of use, and personalisation as metrics for evaluating the quality of the services. These researchers discovered that customer happiness and loyalty are both highly impacted by service quality was validated by earlier research from Djabatiko et al. (2015). According to reports, service quality significantly affects price, reputation, customer satisfaction, switch intention, and product quality (Peng et al., 2014).

### **Fair price**

Numerous aspects must be considered when determining how prices impact consumer satisfaction. For instance, studies have looked at how elements like fair pricing, price knowledge, and perceived price impact consumer satisfaction. Consumer satisfaction may be influenced by various variables, including product and service quality, price, and personal and environmental situations, according to a study by Wilson, Zeithaml, Bitner, and Gremler (2008). The study's authors place a strong emphasis on cost. Price may influence customer happiness, service quality, product quality, and trust (Adi & Yoestini, 2012; Haghghi, Dorosti, Rahnama, & Hoseinpour, 2012; Kusumanegara & Sutopo, 2012; Runtunuwu et al., 2014). The current investigation found a connection between pricing and consumer satisfaction. Haghghi et al. (2012) determined the degree of restaurant patron loyalty. In their study, food was connected to customer happiness. Customer satisfaction was linked in their study to food quality, price, and service quality.

### **Customer satisfaction**

Customers' experiences after trying out a product or service are used to compile a summary of their comments, known as customer satisfaction. According to Yan and Chau's (2013) research, a customer's satisfaction can also be described as a compilation of their opinions on various aspects of the services they receive, with the customer weighing the difference between the benefits they receive and the costs they pay against the benefits they expected to receive. The significance of measuring and tracking customer satisfaction since doing so can yield essential and crucial information for determining a customer's purchase intention as well as forecasting the customer's propensity to return and make more purchases (Baker & Crompton, 2000. (Petrick, Morais, & Norman, 2001; Jang & Feng, 2007). The positive relationship between customer satisfaction and the intention to return was noticed by Oliver and Burke (1999). As a result, a customer's degree of satisfaction plays a crucial role in determining whether or not they will return to a restaurant. The likelihood of recurring business and product returns is closely correlated with the customer's level of satisfaction.

### **Research Hypothesis**

Three hypotheses have been tested in this study, namely:

H1: There is a significant relationship between the physical environment on customer satisfaction among millennials toward Homegrown Café at Kota Bharu.

H2: There is a significant relationship between service quality on the level of satisfaction of customers among millennials toward Homegrown Café at Kota Bharu Kelantan.

H3: There is a significant relationship between fair prices on the level of satisfaction of customers among millennials toward Homegrown Café at Kota Bharu Kelantan.

### Research Framework

A research framework has been conducted to investigate the connection between the variables of the study. The study's dependent variable is the factor influencing customer satisfaction among millennials toward homegrown cafes in Kota Bharu. On the other hand, independent variables included physical environment, service quality, and fair price.

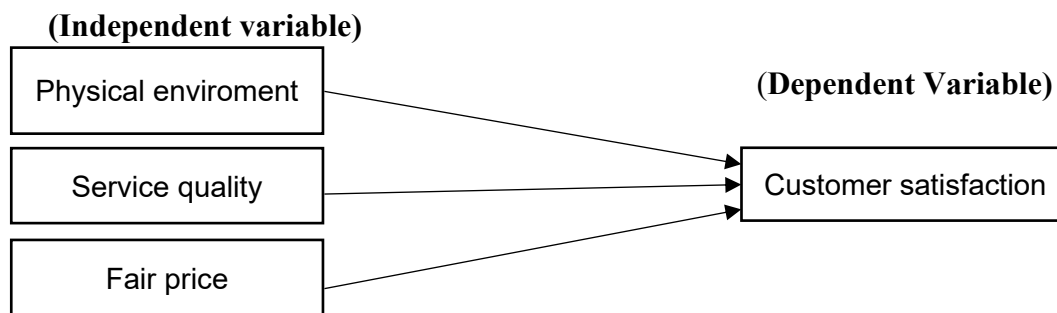

Figure 1: Factor influencing customer satisfaction among millennials toward homegrown café in Kota Bharu  
Source: (Michael Amaral,2015)

## METHODOLOGY

### Research Design

This study uses a quantitative approach, and 384 respondents from the millennial generation were given a questionnaire on a locally owned café in Kota Bharu, Kelantan. Young adults in Kelantan are the focus of this investigation. This study was carried out to ascertain the factors impacting millennials' satisfaction with a locally owned café in Kota Bharu, Kelantan. Parts A, B, C, D, and E were used by the researcher to split the questionnaire into four sections. The questionnaire's Part A asked for general information on the respondents' demographic profile, including their gender, age, marital status, and occupation. The questions for Sections B, C, D, and E provide further information on the independent and dependent variables, which are (i) the physical environment, (ii) service quality, (iii) fair price, and (iv) customer satisfaction. This survey has a 5-point Likert scale of agreement and a multiple-choice style.

### Data collection

To fill out the data requirements for a non-probability sample with gathers the information utilizing an online questionnaire like Google Forms. Using an online questionnaire and social media platforms that randomly distributed assignments. The intended respondents are both genders and are at least 18 years old.

## Sampling

The convenient sampling method were chosen for this study. This sampling method allows every member of the population to have an equal opportunity to be selected. The target population in this research are millennial in Kota Bharu, Kelantan. Based on Krejcie and Morgan (1970) the appropriate sample size for this study is 384 people from a total of 131471 millennials in Kota Bharu, Kelantan. The total number of populations have been derived from the statistic released on millennial in Kota Bharu, Kelantan.

The study's second objective is to investigate factors influencing millennials' usage of a locally owned café in Kota Bharu. Therefore, the study's respondents would be those who had dining experiences at locally owned cafés in Kota Bharu, Kelantan. It employed a Likert Scale to simplify the survey question for responders. It is a 5-point scale inquiry that runs from one extreme attitude to another and is occasionally called a satisfaction scale.

## Data Analysis

This study uses four data analysis types: descriptive statistics, reliability statistics, and Pearson's correlation. The data obtained were analyzed by using SPSS version 26. The use of SPSS in the study helps to achieve the research objectives and helps to process the data that obtained.

## FINDINGS

### Result of Demographic Analysis

Table 1: Frequency Analysis

Demographic	Frequency	Percentage
<b>Gender</b>		
Male	115	29.9
Female	269	70.1
<b>Age</b>		
18- 21 years old	52	13.5
22 - 26 years old	164	42.7
27 - 30 years old	104	27.1
31 - 34 years old	64	16.7
<b>Martial status</b>		
Married	122	31.8
Single	262	68.2
<b>Occupation</b>		
Government sector	41	10.7
Private sector	101	26.3
Self-employed	86	22.4
Student	156	40.6

The gender distribution of the 384 respondents that participated in the data collection is shown in Table 1. Both depict how the respondents in this study were split by gender. Among

the responders, women comprised 70.1% of the total (N=269) while men comprised the remaining 29.9% (N=115).

Table 1 presents the age distribution of a total of 348 respondents collected from the data collection. It show that there were a total of four age groups. The findings showed that, of the 384 respondents, 13.5% (N=52) were between the ages of 18 and 21, which represents the majority of respondents. The age group between 22 and 26 years old came in second with 42.7% (N=164). While 27.1% (N=104) of the population are minors, they are in the 27–30 age range. Next, 16.7% (N=64) of the population are in the 31–34 age range.

The marital status distribution of a total 384 of respondents collected from the data collection. Based on Table 4.3 and Figure 4.3, a total of 98.2% (N=262) reported that they were single. While a small percentage which is 31.8% (N=122) of the total respondents were reported married at the time of the survey.

According the table 1 that represent the occupation distributions of a total of 384 respondents. The highest occupation among the respondents was student with 40.6% (N=156) respondents. The private sector was the second highest number with 26.3% (N=101) respondents. Self-employed represented 22.4% (N=86) of respondents. While there were 10.7% (N=41) of respondents were Government sector.

## Result of Descriptive Analysis

Table 2: Descriptive Analysis

Variable	Items	Mean Score	Standard Deviation
<b>Physical environment</b>	The lighting of the cafe while dining in	4.03	0.836
	The decoration of the cafe and the facilities provided	4.13	0.790
	Ambience condition that refers to the music, temperature, and scent	4.02	0.816
<b>Service quality</b>	The responsive provide to the customer by the staff	4.13	0.782
	The staff provide knowledge and help to customer based on the menu	4.14	0.727
	The staff shows the intention of caring with understanding what customers need and wants	4.20	0.717
	The cafe produce promised service	4.27	0.685
<b>Fair price</b>	The food and beverages have good values of money	4.31	0.650

<b>Customer Satisfaction</b>	The price for food and beverages is reasonable	4.28	0.662
	The price provided is acceptable	4.25	0.671
	The food and beverages served fulfilled my satisfaction	4.12	0.746
	Homegrown cafe is the best place to try homemade coffee and food	4.06	0.752
	I will recommend my family, friend, and others to go to the homegrown cafe	4.09	0.738
	I will share my experience through the homegrown cafe	4.10	0.815
	The food quality, service quality, and fair prices in homegrown cafes influence my satisfaction	4.14	0.815
	Homegrown can fulfill the millennial's needs and wants	4.10	0.801

The descriptive analysis that showed independent variables was moderate, with a mean of physical environment, service quality and fair price and the dependent variable was customer satisfaction.

### Result of Reliability Analysis

**Table 3 below shows the result of the reliability analysis**

Table 3: Reliability Analysis

Table 3 shows the results of the reliability test. High internal consistency for all questionnaires used for this study had demonstrated (Cronbach's  $\alpha$  ranging from 0.855 to 0.914 alpha coefficients). Reliability analysis ranged by the physical environment, service quality, fair price, and customer satisfaction (0.890, 0.855, 0.858, and 0.914). In measuring the variables that influence customer satisfaction, the result of Cronbach's Alpha has shown reliably that coefficient obtained from the Likert- Scale.

Variables	Cronbach's Alpha	No of items
Physical environment	0.890	3
Service quality	0.855	4
Fair price	0.858	3
Customer satisfaction	0.914	6

## Result of Pearson Correlation Analysis

Table 4 below shows the Pearson Correlation Analysis

Table 4: Pearson Correlation Analysis

Hypothesis	Result	Findings of Data Analysis
<b>H1:</b> Physical environment has a moderately positive relationship with customer satisfaction among millennial toward homegrown cafe in Kota Bharu, Kelantan.	$r = <0.635, p <0.00$ Moderate	<b>H1: Supported</b>
<b>H2:</b> Service quality has a moderately positive relationship with customer satisfaction among millennial toward homegrown cafe in Kota Bharu, Kelantan.	$r = <0.577, p <0.00$ Moderate	<b>H2: Supported</b>
<b>H3:</b> Fair price has a moderately positive relationship with customer satisfaction among millennial toward homegrown cafe in Kota Bharu, Kelantan.	$r = <0.595, p <0.00$ Moderate	<b>H3: Supported</b>

Hypothesis 1 the physical environment had positive correlation between customer satisfaction and the physical environment at substantial correlation ( $r=0.635, p0.00$ ). As a result, this study accepts the alternative hypothesis H1a for Hypotheses 2 while rejecting the null hypothesis H0a.

Hypothesis 2 the service quality there is a positive correlation between customer satisfaction and the physical environment at substantial correlation ( $r=0.577, p0.00$ ) As a result, this study accepts the alternative hypothesis H1a for Hypotheses 2 while rejecting the null hypothesis H0a.

Hypothesis 2 the fair price there is a positive association between customer satisfaction and fair price at substantial correlation ( $r=0.595, p0.00$ ). As a result, the researcher accepted the alternative hypothesis and rejected the null hypothesis.

## DISCUSSION & RECOMMENDATIONS

The first hypothesis (H1) said that there significant relationship between the physical environments on customer satisfaction among millennials toward homegrown café in Kota Bharu. Table 4.11 shows that the physical environment recorded value of the Pearson correlation is  $r = 0.635, p = 0.000$ . So the results support the first hypothesis (H1) which says that the physical environment positively affects customer satisfaction.

Also, Hypothesis 2 (H2) said there is a strong positive relationship between service quality and customer satisfaction. Table 4.11 shows that the service quality recorded value of the Pearson correlation coefficient is  $r= 0.577, p = 0.000$ . So, the result's hypothesis 2 (H2) says that the physical environment positively affects customer satisfaction.



The third hypothesis (H3) said there is a significant relationship between fair prices and customer satisfaction. Based on what was found in Table 4.11 the Pearson correlation coefficient for fair price was found to be  $r = 0.595$ ,  $p = 0.000$ . So, the result supports hypothesis 3 (H3), which says that fair price is related to customer satisfaction. The study found that all of the variables passed the test of reliability test. As a result of the online survey on Google form, the majority of respondents were between 22 to 26 years old, which is 164 people (42.7%).

The first limitation is that some responders were unaware of the questionnaire. Therefore, the researcher should explain the questionnaire and how it is asked. In addition, some respondents said it took too long to complete the questionnaire. Since it takes between ten and fifteen minutes.

Additionally, quite a few target respondents declined to respond to the questionnaire. Some of them may not be interested in the survey's topic and may believe that participating in the survey will be a waste of time as a result, which might be one of the possible explanations. In addition, some of them may not want to divulge the information and believe that there is no benefit to them in responding to the questionnaire, so they choose not to respond. The other limitation of the study is the limited independent variables that are being tested. Other variables that can have an impact on customers' satisfaction with locally owned cafés are not taken into account in this study. The only three variables under test are fair pricing, physical environment, and service quality. This demonstrates that the research was not carried out completely and properly because it only pays attention to three variables.

## CONCLUSION

This study also proposed to examine the factor influencing customer satisfaction (physical environment, service quality, and fair price) among millennials toward homegrown cafes in Kota Bharu. Based on the results, almost all the respondents. Most respondents are very interested in homegrown cafes around Kota Bharu. Respondents also agree that physical environment, service quality, and fair price) have a significant relationship with their satisfaction. They also enjoy the food provided at the homegrown cafe.

## REFERENCES

- A Manual for Selecting Sampling Techniques in Research Munich Personal RePEc Archive.* (n.d.). Retrieved January 2, 2023, from <https://mpra.ub.uni-muenchen.de/70218/>
- Agbor, J. M. (2011). *The relationship between customer satisfaction and service quality: a study of three service sectors in UmeÅ*. DIVA. Retrieved December 20, 2022, from <https://www.diva-portal.org/smash/record.jsf?pid=diva2%3A448657&dsid=-914>.
- Akter, M., Sadekin, M. N., & Patwary, A. K. (2020). An Empirical Study on Students' Satisfaction from Mawlana Bhashani Science & Technology University, Bangladesh. *Review of Economics and Development Studies*, 6(2), 363-379.
- Al Mahmud, S. R. (2020). The effectiveness of Facebook advertisements on purchase intention of customers in Malaysia. *South Asian Journal of Social Sciences and Humanities*, 1(1), 97-104.
- Alom, S., Patwary, A. K., & Khan, M. M. H. (2019). Factors affecting the turnover intention of Bangladeshi migrants in the United Arab Emirates: An empirical study on the hotel industry. *International Journal of Innovation, Creativity and Change*, 8(3), 344-360.

- Arpit Srivastava - Country Marketing & Branding Manager, South Asia & Thailand at Lenzing Group. (2020, December 21). *Homegrown brands gain prominence with consciousness & sustainability as key focuses*. *IndiaRetailing.com*.  
<https://www.indiaretailing.com/2020/12/22/fashion/homegrown-brands-gain-prominence-with-consciousness-sustainability-as-key-focuses/>
- Cha Seong-soo, and Bo-Kyung Seo. "The Factors Influencing Customer Satisfaction with and Revisiting Coffee Shops in Korea: The Moderating Roles of Psychological Value." *Culinary Science & Hospitality Research*, vol. 24, no. 2, Feb. 2018, pp. 1–7, 10.20878/cshr.2018.24.2.001. The Factors influencing Customer Satisfaction with and Revisiting Coffee Shops in Korea\_ The Moderating Roles of Psychological Value.pdf <http://dx.doi.org/10.20878/cshr.2018.24.2.001>
- Cibro, Y. E. B., & Hudrasyah, H. (2017). Factors that influence customer's intentions to revisit café: Case study of Siete Café in Bandung. *Journal of Business and Management*, 6(2), 284-300.  
<http://journal.sbm.itb.ac.id/index.php/jbm/article/view/2161>
- Cummins, R. A., & Gullone, E. (2000, March). Why we should not use 5-point Likert scales: The case for subjective quality of life measurement. In *Proceedings, second international conference on quality of life in cities* (Vol. 74, No. 2, pp. 74-93).  
<https://www.researchgate.net/publication/285682151>
- Fengmin, Z., Baijun, W., Jiangtao, B., Li, L., & Patwary, A. K. (2022). Investigating revisit intention of medical tourists in China through nutritional knowledge, perceived medical quality, and trust in the physiologist: A recommendation on health tourism policy measures. *Frontiers in Public Health*, 10, 893497.
- Hazbar, A. M. H., Alem Mohammed, A., & Karim, A. K. A. (2019). An Empirical Study of Factors Influencing hotel customers' online booking Intention. *مجلة العلوم التربوية و الدراسات الإنسانية*, (5), 1-17.
- Li, L., Ragavan, N. A., Patwary, A. K., & Baijun, W. (2022). Measuring patients' satisfaction toward health tourism in Malaysia through hospital environment, nutritional advice, and perceived value: A study on Chinese exchange students. *Frontiers in public health*, 10, 893439.
- Li, L., Wu, B., & Patwary, A. K. (2022). How marine tourism promote financial development in sustainable economy: new evidences from South Asia and implications to future tourism students. *Environmental Science and Pollution Research*, 29, 1155-1172.
- Li, L., Wu, B., & Patwary, A. K. (2022). The psychosocial factors affecting chinese Outbound Exchange and mobility students' academic performance during COVID-19. *Frontiers in psychology*, 13, 872516.
- Measuring customer satisfaction of a café and coffee shop colony at a traditional market*. (2019). Taylor & Francis.  
<https://www.tandfonline.com/doi/abs/10.1080/15378020.2019.1686897>
- Patwary, A. K., Roy, B., Hoque, R., & Khandakar, M. S. A. (2019). Process of developing a community based tourism and identifying its economic and social impacts: An Empirical study on Cox's Bazar, Bangladesh. *Pakistan Journal of Humanities and Social Sciences*, 7(1), 1-13.
- Sadock Jeremiah. (n.d.). *Chapter Three Research Methodology 1.0. introduction*. Retrieved January 7, 2023, from  
[https://www.researchgate.net/publication/349710855\\_CHAPTER\\_THREE\\_RESEARCH\\_METHODODOLOGY\\_10\\_Introduction](https://www.researchgate.net/publication/349710855_CHAPTER_THREE_RESEARCH_METHODODOLOGY_10_Introduction)
- Soebandhi, S. (2020, October 31). *Service quality and store atmosphere on customer satisfaction and repurchase intention | BISMA (Bisnis dan Manajemen)*.  
<https://journal.unesa.ac.id/index.php/bisma/article/view/7669>

- Sudari, S. (2019). *Measuring the critical effect of marketing mix on customer loyalty through customer satisfaction in food and beverage products* » *Growing Science*.  
<http://growingscience.com/beta/msl/3217-measuring-the-critical-effect-of-marketing-mix-on-customer-loyalty-through-customer-satisfaction-in-food-and-beverage-products.html>
- Sumethokula, P., Patwary, A. K., Srinuanpanc, B., Srinuanpand, C., Suwandee, P., Thammathikul, A., & Phanong, W. (2020). The potential of new tour repackaging for creative tourism among entrepreneurs in Nakhon Si Thammarat. *International Journal of Innovation, Creativity and Change*, 13(10), 1752-1771.
- Wu, B., Liu, S., Wang, J., Tahir, S., & Patwary, A. K. (2021). Assessing the mechanism of energy efficiency and energy poverty alleviation based on environmental regulation policy measures. *Environmental Science and Pollution Research*, 28, 40858-40870.
- Wu, B., Zhai, B., Mu, H., Peng, X., Wang, C., & Patwary, A. K. (2021). Evaluating an economic application of renewable generated hydrogen: A way forward for green economic performance and policy measures. *Environmental Science and Pollution Research*, 1-15.

# **Factors Affecting Student Satisfaction to Visit Cafeteria at University Malaysia Kelantan, Bachok**

**Siti Nor Aziani Binti Mohamad Roslan, Siti Nur Asmahusna Binti Abdul Razak,  
Siti Nurfatiha Binti Muhammad Hasni, Siti Rozaimah Binti Ramlee,  
& Harnidah Binti Samengon**

*Faculty of Hospitality, Tourism and Wellness, Universiti Malaysia Kelantan  
Corresponding email: [harnidah@umk.edu.my](mailto:harnidah@umk.edu.my)*

---

## **ABSTRACT**

This study aims to examine the factors affecting student satisfaction in visiting the cafeteria at University Malaysia Kelantan, Bachok. This study focuses on how satisfied students are with their cafeteria experiences. The researcher wants to know the factors affecting students' satisfaction with visiting the University Malaysia Kelantan, Bachok cafeteria. A questionnaire was designed to collect the information. A total of 375 respondents were students from the University Malaysia Kelantan, Bachok, while conducting the research. As for the result, all of the independent variables studied in this research had significant relationships with the dependent variable. The finding of this research showed that all the hypothesis is accepted.

---

**Keywords: Food Quality, Cleanliness, Price Fairness, Facilities, Student Satisfaction, Cafeteria**

---

## **INTRODUCTION**

According to the Euromonitor International report (2019), the food industry is one of the fastest-growing industries in the global market, and it is growing rapidly in Malaysia. Malaysia is quickly advancing in food service, along with developed and emerging countries worldwide. According to the Malaysian Bureau of Statistics (2017), there were 167,490 food service establishments in 2015, up from 130,570 in 2010, representing a 5.1% annual growth rate. Due to the restaurant industry's two fast expansions, dietary preferences and consumer needs are changing.

The food service providers must strategize their operations to increase competition among the university's cafeteria proprietors. The university has made the space available and permits businesses to participate in the cafeteria. Along with offering education, schools also provide a wide range of services for the convenience of their students, including cafeterias, stationery shops, bookstores, and stores that sell computers (Jung, 2013). Universities and colleges are primarily concerned with keeping students with a number of options available to them, making the demands of university students particularly important. Even while offering top-notch instruction is very important to these universities and colleges, some university administrators are starting to understand and value the idea of providing full services on campus, with culinary services having the potential to play a key role. However, due to improvements in the food sector, college students today have experienced far better environments than they did in the past. As a result, the student cafeteria has changed from the past. In addition, the national income has increased.

Higher education institutions offer one of the best chances to change people's eating habits. Mei (2017) reports that 93% of the students he studied said they would purchase their food and beverages at the university. The factors that most impact students' food purchasing decisions are taste, value, cost, and convenience. According to frequent suggestions, the cafeteria can

benefit from lower food prices and a wider choice of foods. According to the student-as-customer (SAC) paradigm, students are the primary consumers of higher education institutions (Kotler & Clarke, 2012). The research of Tekle and Ruth (2007), students place importance on the food's quality, presentation, and cost at their campus café. It is also evident that while choosing a cafeteria, students emphasize their pleasure with the selection of amenities, the environment, and the food's quality. The attention here is also on food selection, food quality, pricing, available facilities, and operation hours. A food service management evaluation at the university cafeteria can be put into place to see the quality of the services offered to satisfy the students' tastes and increase overall satisfaction. Students can use this to evaluate their degree of satisfaction in relation to their goals.

The purpose of this research study is:

1. To investigate student satisfaction with food quality factors at the cafeteria of University Malaysia Kelantan, Bachok.
2. To analyze student satisfaction with cleanliness at the cafeteria of University Malaysia Kelantan, Bachok.
3. To measure student satisfaction with price at the cafeteria of University Malaysia Kelantan, Bachok.
4. To identify student satisfaction with facilities at the cafeteria of University Malaysia Kelantan, Bachok.

### **Significance of The Study**

This study identifies the satisfaction of students using the cafeteria at the university. In industrial services, perceived quality is considered one of the most important predictors of customer satisfaction. Perceived quality can be further divided by restaurant environments, such as food, cleanliness, price and convenience. This study aims to understand how students buy products and services and what factors can influence them when purchasing products or services. This study also found a relationship between product availability and purchase on student satisfaction.

## **LITERATURE REVIEW**

### **Food Quality**

According to the STANDS4 LLC (2022) research, food quality is referred as a characteristic of food quality that consumers feel is acceptable. These include extrinsic qualities like look, texture, flavor, and internal and external grade standards. The Food Safety Act of 1990 regulates food quality in the United States. Many customers depend on manufacturing and processing standards to determine what ingredients are present for dietary, nutritional, or medicinal reasons.

Based on their distinctive color and appearance, caterers decide which food products to display and sell in the food service sector. This helps catch the user's attention, influencing their decision on whether or not to buy. A good predictor of whether or not a customer will return to a particular restaurant is the quality of the food, which is regarded as one of the important aspects in influencing customer happiness. Research by Lee (2004) and Andaleeb and Caskey (2007) found that the majority of students claimed they would utilize the on-campus food service more frequently if the meal quality improved. In order to influence student happiness, food service administrators, especially those in the institutional food service sector, must have

a deep awareness of students' needs and preferences. as in university dining halls (Ng, 2005; Xi & Shuai, 2009).

A competent food service system can reportedly make students more comfortable and can also reflect well on an institution, according to research by Nuzul and Nor Afini (2016). The cleanliness of the cafeteria itself is the primary aspect of providing quality meal service. While the findings of Jian and Sameeha's (2014) study show that the cafeteria's expanding food selection will result in greater student satisfaction with food service. For instance, if students rate the cafeteria's quality of food service, the satisfaction level is likewise very high. From this, it is clear that maintaining and raising the caliber of the service will result in customers being satisfied with the meal they receive.

### **Cleanliness**

In the course of this study, which was carried out in the cafeteria of the UKM residential college, the researcher discovered that there was unpacked equipment that was not being utilized by the cafeteria, uncovered garbage cans, a dirty floor, and no insect deterrents. This is due to the fact that it is the primary cause of foodborne illness transmission. In order to ensure that the food served must be pure, clean, and safe to eat in order to prevent this foodborne illness, the researcher believes cafeteria owners need to strengthen personal and environmental hygiene protocols and impart knowledge to each of their personnel. The researcher concluded that the personal hygiene practices of food handlers and the cleanliness of the cafeteria has a moderately strong, statistically significant, and beneficial link.

The health status of students or users is positively correlated with the cleanliness of the environment and the equipment, according to Mohd Said et al. (2008). According to the study, cafeteria managers need to be aware of how crucial good hygiene is to students' health. Employers must also ensure no animals are allowed to roam around the cafeteria. According to a study by Mohd Rizal and Nurulaini conducted at the UTM Campus Cafeteria, Skudai, some participants report feeling uneasy when animals roam the dining area since it can impair their appetite. This study used a quantitative research design and a survey approach to collect data using an online questionnaire. The study results found that the most dominant factor is personal hygiene, controlling food and the environment that affects food hygiene.

Based on research conducted by Mohamed et al., (2022) prove that environmental hygiene factors are found to have a significant relationship with students' health levels. Suppose a place that prepares food or drinks is clean and has a welcoming ambiance, such as a cafeteria, restaurant, or similar establishment. In that case, it will significantly impact the people that enter it. As a result, a venue that produces, serves, and sells wholesome, hygienic food or beverages in a setting that adheres to excellent hygiene guidelines is referred to as a clean and healthy site. According to a study done at Awan University, it is important to take cafeteria hygiene factors seriously because they significantly impact students' health when they are served food and beverages. These factors include the food handlers' personal hygiene, the cafeteria's cleanliness, and the knowledge of the food handlers.

### **Price Fairness**

Bowen & Makens (2013) state that one of the key elements influencing how consumers perceive a product's price in terms of quality and value for money is its cost. Price is the amount paid for products or services or the value customers pay for owning or utilizing a good or service. According to a study by Mursalina and Simanjuntak (2021), pricing perceptions, which include affordability, price appropriateness, excellence, and quality that is judged acceptable by consumers, must consider customer buying interests. For instance, price influences the

decision-making process for food services and is also considered once a decision is made, allowing for comparing the many features.

Price is the top student issue in a university food service because students buy meals on a tight budget. Additionally, they stated that if on-campus eating costs were too high for students, they would buy food off-campus instead, where it would be a lower price. In addition, the price offered with a fair and fixed pricing significantly impacts student satisfaction, and it makes sense for customer satisfaction if the price provided is appropriate and fair.

### **Facilities**

Facilities are products or services that help a business achieve its objectives. Most organizational structures provide amenities that help tenants accomplish their business goals (Amilia Hasbullah, 2011). Most faculty canteens still don't meet the physical requirements to be able to offer food services that can satisfy students since the criteria include building and facility components that don't match the standards. Similar to the canteen, several areas still have low ceilings, dim lighting, and few dining areas with tables and chairs.

The cafeteria's primary purpose is to give students and lecturers a place to eat and relax between lessons. Therefore, the cafeteria should first and foremost offer a range of seating. While comfortable sitting is preferred to maximize the user's safety, this can be in the shape of stools, benches, or chairs.

### **Student Satisfaction**

The areas of satisfaction that have received the most attention regarding food service include food quality, cleanliness, price fairness, and amenities. The study's results were thought to help other university administrations include more indicators to boost student satisfaction with their cafeteria services (Chang et al., 2014). The research varies from most others in that it focuses on students' satisfaction from the standpoint of consumer satisfaction rather than providing a standard definition of students' pleasure (Hom, 2002).

In addition to presenting a selected and adjusted definition of student satisfaction, it also presents the client's viewpoint. The current environment of the tertiary education marketplace, where their views on services have to be taken into account and acted upon since they are also fee payers, has created a trending moral prerogative for students who are viewed as customers, despite the risks associated with doing so (Imran, 2018). Customer satisfaction is a customer's view followed by expectations and the experiences of post purchases as per the research conducted by Suchanek and others (Suchanek et al., 2017).

### **Research Hypothesis**

The hypothesis is a prediction or explanation of the relationship between two variables. It implies a systematic relationship between an independent and dependent variable exists. Thus, these are the proposed hypothesis:

**H1:** There is a relationship between food quality of student satisfaction at the cafeteria of University Malaysia Kelantan, Bachok.

**H2:** There is a relationship between cleanliness of student satisfaction at the cafeteria of University Malaysia Kelantan, Bachok.

**H3:** There is a relationship between price fairness of student satisfaction at the cafeteria of University Malaysia Kelantan, Bachok.

**H4:** There is a relationship between student satisfaction facilities at the University Malaysia Kelantan, Bachok cafeteria.

### Research Framework

Figure 1 below shows the research framework used for this study

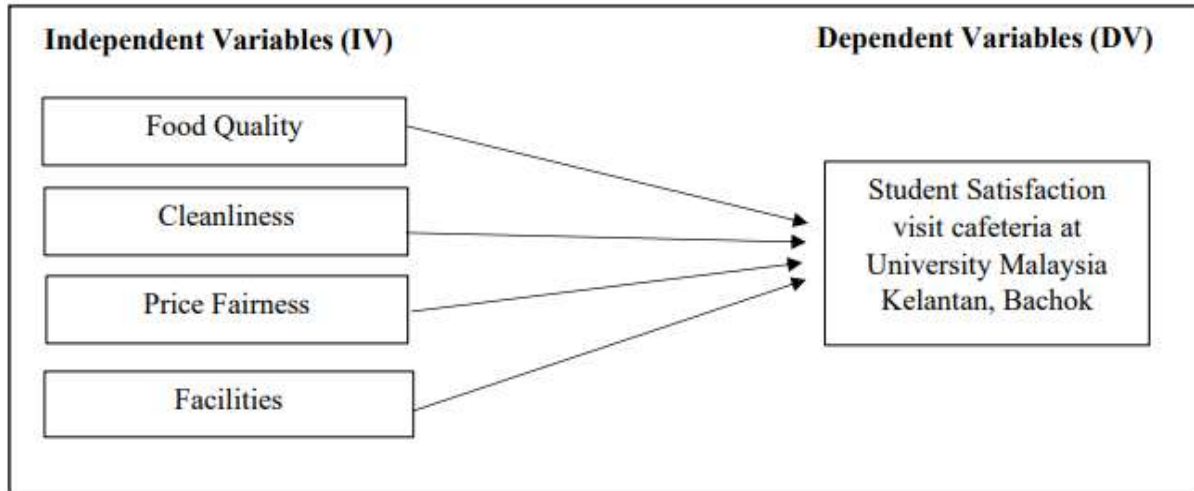

Figure 1: Relationships between the Independent Variables and Dependent Variable

Sources:

There were four independent variables (IV) determined by this study which are food quality, cleanliness, price, and facilities. The dependent variables (DV) include student satisfaction visits to the cafeteria at University Malaysia Kelantan.

## METHODOLOGY

### Research Design

This study uses a quantitative method where a questionnaire was distributed to 375 respondents who used the cafeteria at University Malaysia Kelantan, Bachok. This study's target population is all University Malaysia Kelantan, Bachok students. This study was conducted to determine the factors that affect students' satisfaction in the cafeteria. The researcher divided the questionnaire into four parts, namely parts A, B, C, D, E and F. For Part A, the questionnaire asked for general information about the demographic profile of the respondents, such as gender, age, race, year of study and faculty. For Sections B, C, D, E and F, the questions elaborate on the dependent and independent variables, which are (i) Food Quality, (ii) Cleanliness, (iii) Price Fairness, (iv) Facilities, (v) Student Satisfaction. This questionnaire uses a multiple-choice format and a 5-point Likert scale of agreement.

### Data Collection

Data collection is the most essential analysis to determine the problems. Data collection aids a person or organization in answering essential questions, evaluating outcomes, and forecasting future probability and trends. Data collection is taken online only. The online questionnaire has been sent via WhatsApp to all students of UMK Bachok. It can save time, energy and is easily accessible in all locations with an internet network.



## Sampling

The sampling method used in this study was the probability sampling technique which was simple random sampling. The study uses this method because questionnaires are prepared and distributed online to collect information from respondents. Questionnaires were allocated randomly to all Universiti Malaysia Kelantan, Bachok students who use the cafeteria.

## Data Analysis

This study uses four data analysis types: descriptive statistics, reliability statistics, and Pearson's correlation. The data obtained were analyzed by using SPSS version 25. The use of SPSS in the study helps to achieve the research objectives and helps to process the data that has been obtained.

## FINDINGS

### Result of Demographic Analysis

Table 1: Frequency Analysis

Demographic	Frequency	Percentage
<b>Gender</b>		
Male	163	43.5
Female	212	56.5
<b>Age</b>		
18-20 years old	28	7.5
21 - 23 years old	250	66.7
24 - 26 years old	85	22.7
27 - 29 years old	12	3.2
<b>Race</b>		
Malay	217	57.9
Chinese	64	17.7
Indian	88	23.5
Other	6	1.6
<b>Year of Study</b>		
Year 1	59	15.7
Year 2	115	30.7
Year 3	148	39.5
Year 4	53	14.1
<b>Faculty</b>		
Faculty of Creative Technology Warisan (FTKW)	139	37.1
Faculty of Architecture and Economics (FSE)	124	33.1
Faculty of Language Studies and Human Development (FBI)	112	29.9

A total of 375 questionnaire sets were assigned through the online platform. This portion contained the respondents' contextual profiles. This section focuses on the demographic profile and background of the respondents, including gender, age, race, year of study and faculty.

Table 1 shows the summarized demographic results of the respondent's profiles. The total number of male respondents is 163, while the total number of female respondents is 212. Male respondents comprised 43.5% of the total 375 respondents, while female respondents comprised 56.5%.

As shown by Table 1, the data revealed that the majority of those who answered the questionnaire were between the ages of 21-20 years old, with 250 people answering and a response rate of 66.7%. Then came the 24-26 age group, which had 85 responders and a 22.7% response rate. The age group of 18-20 years old had 28 respondents and a response rate of 7.5%. Finally, 12 people in the 27-29 age group answered the survey, accounting for 3.2% of all respondents.

With 217 responses, the data shows that Malays form most of those who participated in the race (57.9%). Indians came in second with 88 replies, accounting for about 23.5%. The Chinese were next, with 64 answers representing 17.7 percent of the total and six respondents representing 1.6 percent of the total from other races.

At an educational level, most respondents are studying in year 3, with 148 respondents and a value of 39.5%. Respondents from studying in year 2 came in second with 115 respondents and a value of 30.7%, followed by respondents from the study in year 1 with 59 respondents and a value of 15.7%. Finally, studying in year 4 had the lowest response rate, with 53 people responding for a total of 14.1%.

According to the table, the total number of Faculty of Creative Technology Warisan (FTKW) respondents is 139, while the total number of Faculty of Architecture and Economics (FSE) respondents is 124, and the Faculty of Language Studies and Human Development (FBI) is 112 respondents. Faculty of Creative Technology Warisan (FTKW) respondents comprised 37.1% of the total 375 respondents, while the Faculty of Architecture and Economics (FSE) respondents comprised 33.1%, and the Faculty of Language Studies and Human Development (FBI) respondents comprised 29.9%.

## Result of Descriptive Analysis

Table 2: Descriptive Analysis

Variable	Items	Mean Score	Standard Deviation
<b>Food Quality</b>	The appearance of the food is good.	4.10	0.793
	The taste of the food is good.	4.06	0.830
	Food quality is always the same.	4.04	0.896
	Variety of food on display.	4.12	0.784
<b>Cleanliness</b>	The dining area in cafeteria restaurants is virtually clean.	4.04	0.868
	The staffs are clean and neat.	4.06	0.831
	Cleanliness is good.	4.06	0.884
	Food cleanliness.	4.10	0.844
	Eating utensils' cleanliness.	4.07	0.871
<b>Price Fairness</b>	The price of food is written clearly on the menu.	4.10	0.892

	The price is reasonable for the portion served.	4.06	0.837
	I consider the food's price acceptable.	4.12	0.800
	The quality of food is suitable for the price paid.	4.11	0.803
<b>Facility</b>	I always have a place to sit.	4.14	0.752
	The seats are comfortable.	4.13	0.789
	Physical environment.	4.10	0.826
	I like the decorations in the cafeteria.	4.07	0.891
<b>Student Satisfaction</b>	I am pleased with what I get and what I pay.	4.14	0.779
	The staff are friendly.	4.17	0.772
	I feel easy to talk with staff when I'm served.	4.17	0.784
	The serving line move fast.	4.07	0.836

The descriptive analysis that showed independent variables was moderate, with a mean of food quality at 4.083, cleanliness at 4.066, cleanliness at 4.2682, price fairness at 4.0975 and facilities with a 4.112 mean. Furthermore, the means dependent variable verified student satisfaction of 4.1375 as a sub-variable.

### Result of Reliability Analysis

Table 3 below shows the result of the reliability analysis

Table 3: Reliability Analysis

Variable	Number of Items	Cronbach Alpha
Food Quality	4	0.765
Cleanliness	5	0.797
Price Fairness	4	0.817
Facilities	4	0.826

In this variable, the number of items is as follows: food quality (4), cleanliness (5), price fairness (4), and facilities (4). The reliability analysis was conducted in this analysis to determine Cronbach's Alpha values for all variables. The values are as follows: food quality (0.765), cleanliness (0.797), price fairness (0.817), and facilities (0.826). All the reliability was above the 0.9 average, usually considered excellent (Matkar, 2012).

### Result of Pearson Correlation Analysis

Table 4 below shows the Pearson Correlation Analysis

Table 4: Pearson Correlation Analysis

Hypothesis	Result	Findings of Data Analysis
<b>H1:</b> Food quality has a moderately positive relationship with turnover students' satisfaction in visiting the cafeteria at University Malaysian Kelantan, Bachok.	$r = <0.765, p <0.01$ Very high positive	<b>H1: Supported</b>

<b>H2:</b> Cleanliness has a moderately positive relationship with turnover students' satisfaction in visiting the cafeteria at University Malaysian Kelantan, Bachok.	$r = <0.797, p <0.01$ Very high positive	<b>H2: Supported</b>
<b>H3:</b> Price fairness has a strong positive relationship with turnover students' satisfaction visiting cafeteria at University Malaysian Kelantan, Bachok.	$r = <0.817, p <0.01$ Very high positive	<b>H3: Supported</b>
<b>H4:</b> Facilities have a strong positive relationship on turnover students' satisfaction visiting cafeteria at University Malaysian Kelantan, Bachok.	$r = <0.826, p <0.01$ Very high positive	<b>H4: Supported</b>

Hypothesis 1 (H1) proposed that food quality is a positive relationship with students' satisfaction. The finding reported in this study revealed that the reliability recorded value of Pearson Correlation, which is  $r = <0.765, p <0.01$ . Thus, the result accepts hypothesis 1 (H1), whereby reliability is positively significant with students' satisfaction.

Hypothesis 2 (H2) proposed that cleanliness is a positive relationship with students' satisfaction. The finding reported in this study revealed that the responsiveness recorded value of Pearson Correlation, which is  $r = <0.797, p <0.01$ . Thus, the result accepts hypothesis 2 (H2), whereby cleanliness is positively significant with students' satisfaction.

Hypothesis 3 (H3) proposed that price fairness is a positive relationship with students' satisfaction. The finding reported in this study revealed that the price fairness recorded value of Pearson Correlation, which is  $r = <0.817, p <0.01$ . Thus, the result accepts hypothesis 3 (H3), whereby price fairness is positively significant in students' satisfaction.

Hypothesis 4 (H4) proposed that facilities are a positive relationship with students' satisfaction. The finding reported in this study revealed that the empathy recorded value of Pearson Correlation, which is  $r = <0.826, p <0.01$ . Thus, the result accepts hypothesis 4 (H4), whereby facilities are positively significant in students' satisfaction.

## **DISCUSSION AND RECOMMENDATION**

The discussion aims to resolve the questions and address the hypotheses as stated in the first chapter of this study. In general, this study has extensively studied the factors affecting student satisfaction visit cafeteria at University Malaysia Kelantan, Bachok that have a substantial relationship.

Based on the study's findings, facilities had a statistically significant strong positive and significantly affected student satisfaction when visiting the cafeteria at University Kelantan Malaysia, Bachok. As a result of this gap, it is clear that student satisfaction is satisfied.

This study puts its own set of limits on how the test can be carried out. This is because multiple other institutions are scattered across the country, so the study's research is limited to just one. The results of this poll may not be totally generalized to other campuses. As a result, the results do not accurately reflect all Malaysian students' pleasure. This study could be expanded by including all cafeterias at University Malaysia Kelantan, including the Campus Jeli cafeteria.

Furthermore, the researcher has a limited quantity of samples. Only 375 surveys were successfully distributed to University Malaysia Kelantan Bachok students through Google Forms. The limited sample size is unlikely to apply to a larger population. It is recommended that future research should expand the number of respondents from the University Malaysia Kelantan, Bachok students to other diverse categories, such as faculty members and administrative personnel, to ensure that the study's conclusions are more representative.

In addition, these four factors can influence whether students are satisfied when they visit the cafeteria. This is because the researcher concentrates on a limited number of issues, this investigation cannot be completed correctly and extensively. Several cafeterias have experienced various problems due to differing degrees of student satisfaction and affecting factors. As a result, it is recommended that any other factors that may influence students' happiness with the cafeteria be evaluated. Other issues may be investigated in future research.

## **CONCLUSION**

In conclusion, this study has discovered the factors affecting student satisfaction visit cafeteria at University Malaysia Kelantan, Bachok. Four independent variables, food quality, cleanliness, price fairness and facilities been chosen to examine their relationships with the dependent variable, which is the student satisfaction visit cafeteria at University Malaysia Kelantan Bachok. A total of 375 respondents were selected from all students at campus Bachok. Based on Pearson's correlation analysis, the food quality scored a value of \*0.765, followed by cleanliness with \*0.797, price with \*0.817, and facilities with \*0.826. Lastly, this research has determined the relationship between factors affecting university students' satisfaction at the cafeteria.

## REFERENCES

- Adenan, H., & Jais, N. F. (2018). Persepsi Pelajar Terhadap Perkhidmatan Makanan Di Kantin Sekolah Menengah Harian: SMK Dato' Bentara Dalam, Segamat, Johor. *Journal of Hospitality and Networks*, 1(1), 44-56.
- Adenan, H., Zaid, D. S., Amin, S. M. A., & Parid, D. M. (2021). Kepuasan Pelanggan Terhadap Restoran Makanan Segera: Satu Kajian Di Masjid Tanah Melaka. *Journal of Hospitality and Networks*, 1(1), 55-62.
- Akter, M., Sadekin, M. N., & Patwary, A. K. (2020). An Empirical Study on Students' Satisfaction from Mawlana Bhashani Science & Technology University, Bangladesh. *Review of Economics and Development Studies*, 6(2), 363-379.
- Alom, S., Patwary, A. K., & Khan, M. M. H. (2019). Factors affecting the turnover intention of Bangladeshi migrants in the United Arab Emirates: An empirical study on the hotel industry. *International Journal of Innovation, Creativity and Change*, 8(3), 344-360.
- Anshul Garg\*, J. K. (2017). Exploring customer satisfaction with university cafeteria food services. An empirical study of Temptation restaurants at Taylor's University, Malaysia.  
[https://expert.taylors.edu.my/file/rems/publication/100397\\_2716\\_1.pdf](https://expert.taylors.edu.my/file/rems/publication/100397_2716_1.pdf)
- Anuli, U. E., et al. (2022). "A Comparative Study on Food Hygiene and Safety Practices of Local and Contemporary Bread Bakers in the Gambia." *American Journal of Food Science and Technology* 10(4): 153-161.
- Anuli, U. E., Ndimballan, H., Kanteh, A., & Bah, M. L. (2022). A Comparative Study on Food Hygiene and Safety Practices of Local and Contemporary Bread Bakers in the Gambia. *American Journal of Food Science and Technology*, 10(4), 153-161.  
<http://pubs.sciepub.com/ajfst/10/4/2>
- El-Said, Osman Ahmed, and Eslam Ahmed Fathy. "Assessing University Students' Satisfaction with On-Campus Cafeteria Services." *Tourism Management Perspectives*, vol. 16, Oct. 2015, pp. 318–324, 10.1016/j.tmp.2015.09.006. Accessed 26 May 2020.
- Eum, Y. R. (2003). Analysis of Current Operational Practices and Issues of Contract Managed Foodservice Companies in Korea. *Korean Dietetic Association*, 197-208.  
<https://pesquisa.bvsalud.org/portal/resource/pt/wpr-76080>
- Fengmin, Z., Baijun, W., Jiangtao, B., Li, L., & Patwary, A. K. (2022). Investigating revisit intention of medical tourists in China through nutritional knowledge, perceived medical quality, and trust in the physiologist: A recommendation on health tourism policy measures. *Frontiers in Public Health*, 10, 893497.
- Garg, A. (2014). Mechanic clues vs. humanic clues: Students' perception towards service quality of fast-food restaurants in Taylor's University campus. *Social and Behavioral science*, 164-172.  
<https://www.sciencedirect.com/science/article/pii/S187704281404213X/pdf?md5=6a7f73645c92c5ec54e2725d6d9e64b7&pid=1-s2.0-S187704281404213X-main.pdf>

- Gupta, S. Z. (2006). Customer metrics and their impact on financial performance. . *Marketing Science*.  
[https://www.researchgate.net/publication/227442466\\_Customer\\_Metrics\\_and\\_Their\\_Impact\\_on\\_Financial\\_Performance](https://www.researchgate.net/publication/227442466_Customer_Metrics_and_Their_Impact_on_Financial_Performance)
- Hazbar, A. M. H., Alem Mohammed, A., & Karim, A. K. A. (2019). An Empirical Study of Factors Influencing hotel customers' online booking Intention. *مجلة العلوم التربوية و الدراسات الإنسانية*, (5), 1-17.
- Jung, H. Y. (2013). A study on utilization and perceived service quality of the university foodservice. *Korean Society of Food Science and Nutrition*, 633-643.  
<https://doi.org/10.3746/JKFN.2013.42.4.633>
- Li, L., Ragavan, N. A., Patwary, A. K., & Baijun, W. (2022). Measuring patients' satisfaction toward health tourism in Malaysia through hospital environment, nutritional advice, and perceived value: A study on Chinese exchange students. *Frontiers in public health*, 10, 893439.
- Li, L., Wu, B., & Patwary, A. K. (2022). How marine tourism promote financial development in sustainable economy: new evidences from South Asia and implications to future tourism students. *Environmental Science and Pollution Research*, 29, 1155-1172.
- Li, L., Wu, B., & Patwary, A. K. (2022). The psychosocial factors affecting chinese Outbound Exchange and mobility students' academic performance during COVID-19. *Frontiers in psychology*, 13, 872516.
- Misiran, M., Yusof, Z. M., Sapiri, H., & Abdullah, I. (2022). Students Satisfaction Towards Cafeteria in University Campus—A Case Study: Students Satisfaction Towards Cafeteria in University Campus. *Journal of Statistical Modeling & Analytics (JOSMA)*, 4(2).
- Mohamed, H. A.-B., Hamid, N. S., Baker, R., Ramlee, S. N. S., & Saleh, M. M. H. (2022). Faktor-Faktor Kebersihan Yang Mempengaruhi Tahap Kesehatan Mahasiswa: Satu Kajian Kes Di Sebuah Universiti Awam, Malaysia.
- Patwary, A. K., Roy, B., Hoque, R., & Khandakar, M. S. A. (2019). Process of developing a community based tourism and identifying its economic and social impacts: An Empirical study on Cox's Bazar, Bangladesh. *Pakistan Journal of Humanities and Social Sciences*, 7(1), 1-13.
- Saglik, E., Gulluce, A., Kaya, U., & Ozhan, C. (2014). Service quality and customer satisfaction relationship: A research in Erzurum Ataturk university refectory. *American International Journal of Contemporary Research*, 4(1), 100-117.
- Said, M. R. B. M., & Arif, N. B. M. (2008). Persepsi Pelajar Universiti Teknologi Malaysia Terhadap Perkhidmatan Makanan Di Kafetaria Kampus UTM, Skudai.
- Sino, H., Mahadi, Z., Haron, H., Misrin, M. A., ISMAIL, N. I., & Mustapa, M. H. (2013). Hubungan di antara Amalan Kebersihan Diri Pengendali Makanan dan Kebersihan Kafetaria di Kolej Kediaman UKM. *Malaysian Journal of Health Sciences/Jurnal Sains Kesihatan Malaysia*, 11(1).

- Sumethokula, P., Patwary, A. K., Srinuanpanc, B., Srinuanpand, C., Suwandeee, P., Thammathikulf, A., & Phanong, W. (2020). The potential of new tour repackaging for creative tourism among entrepreneurs in Nakhon Si Thammarat. *International Journal of Innovation, Creativity and Change*, 13(10), 1752-1771.
- Truong, N., Nisar, T., Knox, D., & Prabhakar, G.. (2017). The influences of cleanliness and employee attribute on perceived service quality in restaurants in a developing country. *International Journal of Culture, Tourism and Hospitality Research*, 11(4), 608–627. <https://doi.org/10.1108/ijcthr-11-2016-0111>
- Wu, B., Liu, S., Wang, J., Tahir, S., & Patwary, A. K. (2021). Assessing the mechanism of energy efficiency and energy poverty alleviation based on environmental regulation policy measures. *Environmental Science and Pollution Research*, 28, 40858-40870.
- Wu, B., Zhai, B., Mu, H., Peng, X., Wang, C., & Patwary, A. K. (2021). Evaluating an economic application of renewable generated hydrogen: A way forward for green economic performance and policy measures. *Environmental Science and Pollution Research*, 1-15.
- Yusoff, N. A., & Hashim, A. B. (2009). Persepsi Pelajar Terhadap Tahap Kebersihan Makanan Di kafeteria-kafeteria Di Utm Skudai Universiti Teknologi Malaysia].



# MEASURING ECO - TOURIST PERCEPTION, KNOWLEDGE, ACCEPTANCE AND REVISIT INTENTION IN MALAYSIA

SUMMETA A/P SUGUMARAN (H20A1825), SITI SARAH BINTI SHAMSUDDIN  
(H20A1815), SYAMIMI BINTI AZIZ (H20A1831), SUKPHIN A/P EH BOON  
(H20A1824) & \*DR. ATAUL KARIM PATWARY

*Faculty of Hospitality, Tourism and Wellness, University Malaysia Kelantan*

*Corresponding email: ([ataul.kp@umk.edu.my](mailto:ataul.kp@umk.edu.my))*

---

## ABSTRACT

The purpose of this study is to identify various problems found in various sectors of ecotourism. Most of them are problematic about community thinking, lack of understanding about ecotourism activities, lack of facilities, and so on. The objective of this study is to study the influence of ecotourism according to perception, knowledge, and acceptance on the intention to revisit Malaysia. Concerning that, the quantitative philosophy is utilized in this review. The straightforward size inspecting is utilized as an examining outline. The absolute number of 150 respondents were designated and examined utilizing the Measurable Bundle. The result from this study is to measure eco tourist perception, knowledge, acceptance, and revisit intention in Malaysia. The finding from this exploration is believability to draw in for the future examination. This study will be beneficial to appreciate the nature and knowledge while research has been done. Practitionery among people can be gained to appreciate the nature place when they can get knowledge and acceptance towards to take care eco-tourist place in Malaysia.

**Keywords: Eco-Tourism perception, Knowledge, Acceptance, Revisit intention.**

---

## INTRODUCTION

This research would be beneficial to the Malaysian's Eco-Tourism because they will know the perception, knowledge, acceptance, and revisit intention among tourist in Malaysia. In this study the Malaysian's Eco-Tourism can alert in the performance part of the tourism in Malaysia. The research would also be beneficial to the economy because the profit of the country will be able increase for better future for Malaysian's people. Government can easily to detect the problem occur and any step could be taken to make sure the Eco-Tourism in Malaysia run smoothly in every year. This research would be helping the local people who

work in this field to know the perception, knowledge and more to attract the local and international tourist in Malaysia. Another that, this exploration would be useful to the future specialist since they can get some data that could require in their examination and a portion of their inquiry may conceivably be responded to by this exploration.

### **Significant of Study**

This research would be beneficial to the Malaysian's Eco-Tourism because they will know the perception, knowledge, acceptance, and revisit intention among tourist in Malaysia. In this study the Malaysian's Eco-Tourism can alert in the performance part of the tourism in Malaysia. The research would also be beneficial to the economy because the profit of the country will be able increase for better future for Malaysian's people. This research would be helping the local people who work in this field to know the perception, knowledge and more to attract the local and international tourist in Malaysia. Satisfaction among tourist is the key word to success in any business when the needs of them be fulfilled. Another that, this exploration would be advantageous to the future specialist since they can get some data that could required in their examination and a portion of their inquiry may conceivably be responded to by this examination.

## **LITERATURE REVIEW**

According to the guidelines, chapter two refers to several parts starting from the literature review, which is to describe the perception, knowledge, and acceptance, and review the intentions related to ecotourism. next is to explain the three hypotheses in this study. Besides that, the conceptual framework shows the connection between the free factor (IV) and the reliant variable (DV) and closes with a rundown. This study aims to measure eco-tourists' perception, knowledge, acceptance and intention to revisit in Malaysia.

### **Perception**

The perception of tourist on eco-tourism is very important to the nature conversation. As previously mentioned in the chapter 1 where eco-tourism extremely provides a huge revenue to the community and the country specially to set up and develop the nature conversation schemes. Ecotourism promotes the stewardship of natural and cultural resources while also

assisting in their conservation (Kasalak & Akinici ,2015). However, achieving the stated objectives is difficult without the strong support and participation of the local population. The purpose of this study was to comprehend how the local population saw the benefits and significance of ecotourism (Figueroa-Domecq & Segovia-Perez ,2020).

### **Knowledge**

According to the definition that academics, professionals, and private conservation organisations have worked to develop since 1960, ecotourism emphasises the development of environmental conservation behaviour and thought patterns in addition to the enjoyment of the stunning ecological landscape found within tourism areas (Gupta. G, 2014). The objective is to guarantee that tourist-related activities persist for a long time and can preserve social, ecological and more as well as a balanced growth of sustainable tourism. Ecotourism serves to preserve the environment and promote local development that is sustainable and can benefit all stakeholders (e.g., regional ecological managers, community residents, local tourism operators, and tourists) (Niñerola, A, 2019).

### **Acceptance**

Acceptance among tourist that involving them to more get knowledge in eco-tourist make this sector getting bigger in every year. The knowledge and promoting about this tourism sector especially in the online platform, can spread it to other people in different generation. (Ulfy, 2021). Acceptance means fully acknowledge the facts of a situation and not fixating on how it should not be that way. The participation local community to joining and supporting this park especially who live near the tourism areas can together to protect it. The present study determines the local communities to participate in ecotourism development at the tree National Parks, specifically Taman Negara Kuala Koh, Taman Negara Kuala Tahan, and Taman Negara Merapoh. (Hui, 2020)

### **Revisit Intention**

Intention to travel again before the tourists decide to go again, the place they have visited must have several factors that make them feel impressed and interest them to visit the area again. Factors that can attract tourists to travel in ecotourism areas are largely the awareness

of tourists towards the environment mass tourism" to special interest tourism "ecotourism" (Agarwal et al., 2018). Now there are trends that are always followed in social media that encourage doing good activities that do not have a negative impact on the environment of the thing they will choose is to participate in eco-tourism activities. Tourism is an interesting activity because they can visit interesting areas to get beautiful scenery.

## **Research Hypotheses**

### **H1: Eco-tourist perception is positively related to revisit intention.**

Eco-tourist is recognized as the important thing to know if can affects local communities' perception of natural resources and be important determinants of conversation behaviour. Moreover, it is encouraged positive experiences for visitors and as well as hosts. (Waylen, 2019) The positive perception that has been given make the other people involve them in positive vibe on how important the nature place must be protected from any harm to make sure of future generation can try to visit this beautiful scenery in their own country beside improve the economy. They will revisit and visit any nature place to make sure they can get experience again how to appreciate the nature beside helping the local ecotourism agency.

### **H2: Eco-tourist knowledge is positively related to revisit intention.**

Knowledge about the exploring nature place would increase beside to know well about different species plants and animal in that place who is very difficult to find it in certain place. Beside that, it is also encouraging the tourist to get the knowledge to encourage them to protect the nature place in Malaysia. Such as mountain, forest, beach and more that provide the local community with jobs. Awareness would be spread, if the visitor visits that place to increase more awareness and avoid causing destruction to the living things around them beside revisit intention would be focusing on this topic. According to the Brooking (2022) responsible travel to natural areas that conserves the environment, sustains the well-being of the local people, and involves interpretation and education. They would revisit the place because the attractiveness knowledge and want to gain more about it.

**H3: Eco-tourist acceptance is positively related to revisit intention.**

As indicated by the Global Ecotourism Society, ecotourism is characterized as capable travel to regular regions that preserves the climate and further develops the prosperity of nearby individuals. Malaysia has huge biodiversity, to gives the travel industry area to push ahead and drawing in guests to encounter it. From that, the advertising in social media is updated continuously to ensure the people can get information about eco-tourist in online platform and make more of them more accept the uniqueness natural areas surrounding them to visit. (Ulfy, 2021).The increasing acceptance among tourist, the higher number of revisit attention would be if they accept and appreciate the beautiful nature place in Malaysia.

**Research Framework**

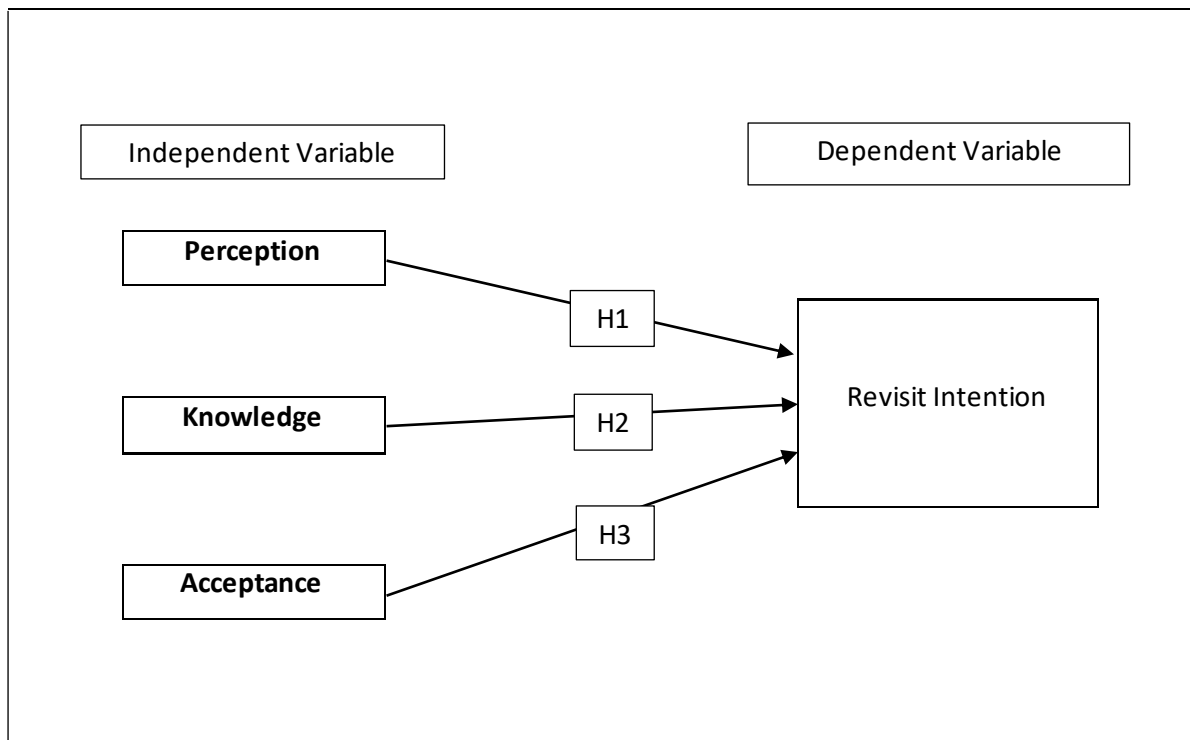

**Figure 1: Research Framework**

Based on figure 1 above, independent variables are the parameters that impact the revisit intention in Malaysia. The dependent variable (DV) is revisit intention in Malaysia. In this analysis, three independent variables (IV) determined measuring eco-tourist perception, knowledge and acceptance. The independent (IV) and dependent variable (DV) that will be

used in this study are seen in figure 1. This figure demonstrates the relationship between tourist perception, knowledge and acceptance impact with revisit intention in Malaysia on eco-tourist.

## **METHODOLOGY**

### **Research Design**

Research configuration is a technique for responding to address utilizing experimental information. Making an exploration configuration implies coming to conclusions about in general examination targets and approach, the kind of exploration configuration will be use, information assortment techniques, information examination strategies and that's only the tip of the iceberg. A well-planned research design may help ensure the methods match with research objectives and the right kind of analysis data. (McCombes, 2021). There are few elements of good research design that incite great results, for examples data collection methods, techniques of research data analysis, types of research methodologies and more. (Damera, 2022).

### **Data Collection**

The definition of data collection as a method for acquiring, measuring, and assessing accurate insight into an investigation uses standard, verified techniques. (Kumar ,2018). The researchers would test their theory using the data they had gathered. Information assortment is likewise the most common way of social event and estimating data on factors of interest, in a laid out methodical design that empowers one to respond to expressed research questions, test speculations, and assess results. For this research, the data has been collected through using online questionnaires and face to face questionnaires. The respondents were named anonymously to an anonymous questionnaire.

### **Sampling**

According to Wilson (2010), convenience sampling is the most suitable survey strategy. So, this sampling is chosen depending on the characteristics of the population and the objectives of the study. Convenience sampling will be selected by state and district; 150 participants will be selected to answer the questionnaire. The method of research is using a questionnaire through Google Forms. The researcher needs to ensure that this sample is typical for studying tourists who visit ecotourism places in Malaysia.

## Data Analysis

After the data collection completed, all the data gathers will be analysed using by the IBM Statistical Package for Social Science (SPSS). The analyses procedure for the research is divided into three procedures: descriptive statistics, reliability test and Pearson Correlation. According to LeCompte and Schensuly, Researchers (2003) utilize research data analysis as a method for transforming data into a narrative and then evaluating it to draw conclusions. It seems OK that the information examination strategy supports separating a major measure of information into more modest valuable substance. There are various data analysis processes where it will filter the useful information and data from overall findings.

## FINDINGS

### Demographic Analysis

**Table 4.1: Respondents' Gender**

<b>Gender</b>	<b>Frequency</b>	<b>Percentage (%)</b>
Male	37	24.7
Female	113	75.3
Total	150	100.0

The table above displays the frequency and percentage of respondents by gender. 150 respondents provided responses to the questionnaire. There are 37 of them, or 24.7% of the total, who are men. The remaining 113 people, or 75.3 of the totals, are female. This finding demonstrates that male and female respondents' proportion is nearly equal, increasing validity of the research.

**Table 4.2: Respondents' Age Group**

<b>Age</b>	<b>Frequency</b>	<b>Percentage (%)</b>
18-22 years old	52	34.7
23-27 years old	54	36.0
28-32 years old	30	20.0
33 years old and above	14	9.3
Total	150	100.0

The age range of each responder who filled out our questionnaire is represented in this table. Five groups have been created based on the ages of all responders. 52 respondents (30.9%) in the 18 to 22 age group fell into this category. Following that, 54 was the highest frequency of all with (36.0 %) of those questioned were between the ages of 23 to 27 years old. The third largest number of respondents to our poll belonged to this age bracket. The following group of 30 responders (20.02%) fell within the 28 to 32 age range. In addition, 33 years old and above with 14 (9.3 %) of respondents completed this questionnaire.

**Table 4.3: Respondents' Marital Status**

<b>Marital Status</b>	<b>Frequency</b>	<b>Percentage (%)</b>
Single	101	67.3
Married	49	32.7
Total	150	100.0

This table displays the respondents' marital status. The percentage of singles who are married (67.3%) and have 101 frequencies. This marital status for singles is the highest compared to married status. Following by marital status for married is 49 (32.7%).



**Table 4.4: Respondents' Occupation**

<b>Occupation</b>	<b>Frequency</b>	<b>Percentage (%)</b>
Student	81	54.0
Self Employed	20	13.3
Private sector	24	16.0
Government sector	23	15.3
Retired	2	1.3
Total	150	100.0

The occupation for all the respondents has been shown in the table 4.4. The frequency with 81 (54.0%) is for the student occupation level. Which is the highest of all. Next, 20 (13.3%) for the self-employed occupation level for the respondent. The private sector with 24 frequencies with (16.0%) is the second highest compared to student occupation. Followed by the government sector with 23 frequency (15.3%). Lastly, retirement is the least frequency level of all which is 2 (1.3%).

**Table 4.5: Respondents' Monthly Income**

<b>Monthly Income</b>	<b>Frequency</b>	<b>Percentage (%)</b>
Below RM1500	78	52.0
RM1600- RM2500	17	11.3
RM2600-RM3500	23	15.3
RM3500 and above	32	21.3

Total	150	100.0
-------	-----	-------

Table 4.5 displays the monthly pay grades for each respondent. 78 people, or 52.0% of those making less RM1500. In terms of the total number of questionnaires, this is also the largest category. Then, 17 (11.3%) of the respondents stated that their monthly income ranged from RM1600 to RM2500. Furthermore, 23 respondents (15.3%) stated that their monthly income ranged from RM2600 to RM3500. After that, 32 (21.3%) respondents reported having a monthly salary of RM3500 or more. These numbers demonstrate that the respondents who filled out the survey were fairly evenly dispersed across a range of income levels.

### Descriptive Analysis

Data sets that gather information can be summarized in simple terms narratively or quantitatively. With this overview, you can contextualize the data collected and turn it into useful information that facilitates understanding of your research.

**Table 4.7: Descriptive Analysis Statistic of Perception**

No	Item Description	N	Mean	Level of Agreement
1.	Ecotourism contributes to the effort of saving the forests	150	3.74	Agree
2.	Ecotourism improves the quality of life of the local communities	150	3.67	Agree
3.	Ecotourism helps in improving visitor awareness on the importance of conservation	150	3.86	Agree

The mean of each query in the first independent variable on average, which is perception, displayed in this table. The thing with the next-highest average level is “Ecotourism contributes to the effort of saving the forests”, with the mean 3.74 score and the level of the agreement was agreed. Follow by, the least score among other perception is “Ecotourism improves the quality of life of the local communities”, with the mean of 3.67 with the level of agreement was agreed. The highest result is 3.86 for the item ‘Ecotourism helps in improving visitor awareness on the importance of conservation’ with agreement level was agreed.

**Table 4.8: Descriptive Analysis Statistic of Knowledge**

No	Item Description	N	Mean	Level of Agreement
1.	Contemporary philosophy and ethics toward ecotourism.	150	3.72	Agree
2.	Basic ecological and geomorphological principles.	150	3.70	Agree
3.	Wildlife and vegetation dynamics and interrelationship.	150	3.80	Agree
4.	Environmental impact occurrence and management relating to ecotourism.	150	3.64	Agree
5.	Ecologically sustainable development and environmental management principles.	150	3.75	Agree
6.	Cultural heritage and cultural heritage management principles.	150	3.95	Agree

This table displays the average mean for each question in the knowledge-related second independent variable. The thing that has the greatest mean level is “Cultural heritage and cultural heritage management principles” with the mean 3.95 score and the level of the agreement was agreed. Follow by, the least score among other knowledge with the mean of 3.64 with the level of agreement was agreed. The rest of the item was count as moderate with the mean 3.72 and with the mean 3.70 which both items were agreed. The other item which is the mean 3.80 and 3.75 respectively also was agreed.

**Table 4.9: Descriptive analysis of Acceptance**

No	Item Description	N	Mean	Level of Agreement
----	------------------	---	------	--------------------

1.	I am accepted to receive ecotourism.	150	3.76	Agree
2.	I accepted to support the protection of natural resources and the environment.	150	3.86	Agree
3.	I accepted to participate in ecotourism development.	150	3.84	Agree
4.	I accepted ecotourism gives benefit to local.	150	3.91	Agree
5.	I accepted ecotourism is necessary in protected areas.	150	3.88	Agree

The acceptance-related second independent variable's average mean for each question is displayed in this table. The statement "I accepted ecotourism gives benefits to locals" has the greatest mean level, with a mean 3.91 score, was agreed. Lowest rating among the other acceptances is then "I am accepted to receive ecotourism", with the mean of 3.76 with the level of agreement was agreed. The rest of the item was count as moderate which is "I accepted to support the protection of natural resources and the environment" with the mean 3.86 and "I accepted to participate in ecotourism development" with the mean 3.84 which both items were agreed. The item which is "I accepted ecotourism is necessary in protected area" with the mean 3.88 also was agreed.

#### 4.10: Descriptive analysis of Revisit Intention

No	Item Description	N	Mean	Level of Agreement
1.	Facilities at the entertainment areas are well maintained.	150	3.68	Agree
2.	The staff provide prompt, reliable, and friendly service.	150	4.02	Agree
3.	I feel relaxed to visit here.	150	4.08	Agree

4.	I feel peaceful to visit here.	150	4.07	Agree
5.	Local residents are responsiveness.	150	4.00	Agree

Table below shows the average mean for each question in the second dependent variable, which is revisit. "I feel relaxed to visit here" has the greatest mean level, with a mean 4.08 score, and the degree of agreement was agreed upon. The lowest rating among the subsequent visits is "Facilities at the entertainment areas are well maintained", with the mean of 3.68 with the level of agreement was agreed. The rest of the item was count as moderate which is "The staff provide prompt, reliable, and friendly service" with the mean 4.02 and "I feel peaceful to visit here" with the mean 4.07 which the both items were agreed. The item which is "Local residents are responsiveness" with the mean 4.00 also was agreed.

### Reliability Analysis

Consistent measurement of a specific spectacle is one that is reliable and yields reproducible results. Additionally, it relates to occurrences of consistency. Piece of research is regarded as trustworthy if the outcomes of repeated measurements with constant variables are the same. Cronbach's alpha was used to evaluate the validity of the study. Cronbach's alpha is a scale from 0 to 1 that represents the degree of internal consistency.

**Table 4.12: Results for Reliability Analysis**

<b>Item Description</b>	<b>N.</b>	<b>No. of items</b>	<b>Cronbach's Alpha</b>
<b>Perception</b>	150	3	<b>0.800</b>
<b>Knowledge</b>	150	6	<b>0.882</b>

<b>acceptance</b>	150	5	<b>0.877</b>
<b>Revisit intention</b>	150	5	<b>0.802</b>

Table 4.12 lists the results of the reliability analysis with respect to each independent and dependent variable. The first of the three independent components overall is perception. With a Cronbach's Alpha of 0.800 and a total of three entries ( $0.9 > 0.8$ ), this variable exhibit respectable internal consistency.

Reliability and validity of knowledge, the following independent variable, are assessed using six questions. Cronbach's Alpha for this variable is 0.882. Internal consistency is good for this figure ( $0.9 > 0.8$ ). Acceptance serves as the final and third independent factor in the investigation. This variable also has strong internal consistency with a Cronbach's Alpha value of 0.877 and five items below it ( $0.9 > 0.8$ ). This independent for variable is hence sturdier compared to the other two.

There are four items below the dependent variable, revisit intention, that cast doubt on its validity. This variable is 0.802, which indicates that it has good internal consistency ( $0.9 > 0.8$ ). This suggests that respondents had comparable viewpoints regarding revisit intention. All of the studies in this study are said to be reliable, but their reliability varies from good to poor ( $0.9 > 0.8$ ). At last, the absolute unwavering quality test for all factors is 0.940, which is viewed as really great for dependability.

### **Pearson Correlation Analysis**

Finding variances and/or correlations between variables using inferential analysis (also known as correlation analysis) is a common practise in research and studies. The independent variables are the perception of eco-tourists, their knowledge and acceptance, and their willingness to return to Malaysia.

**Table 4.14: Related Factors Affecting Revisit Intention**

		MEAN_Perception1	MEAN_Knowledge1	MEAN_Acceptance1	MEAN_Revisit1
MEAN_Perception1	Pearson Correlation	1	.621**	.703**	.551**
	Sig. (2-tailed)		.000	.000	.000
	N	150	150	150	150
MEAN_Knowledge1	Pearson Correlation	.621**	1	.683**	.612**
	Sig. (2-tailed)	.000		.000	.000
	N	150	150	150	150
MEAN_Acceptance1	Pearson Correlation	.703**	.683**	1	.784**
	Sig. (2-tailed)	.000	.000		.000
	N	150	150	150	150

MEAN_Revisi t1	Pearson Correla tion	.551**	.612**	.784**	1
	Sig. (2- tailed)	.000	.000	.000	
	N	150	150	150	150

\*\* . Correlation is significant at the 0.01 level  
(2-tailed).

#### Hypothesis 1

H1o: Eco-tourist perception is negatively not related to revisit intention.

H1a: Eco-tourist perception is positively related to revisit intention.

The relationship between eco-tourist perception and intention to return is seen in the table above for Malaysia. There is a significant positive correlation between the two variables, which is the explanation for the results of 0.551. This demonstrates that a significant portion of respondents believe that Malaysian tourists' perceptions of ecotourism will affect their decision to return.

#### Hypothesis 2

H2o: Eco-tourist knowledge is negatively not related to revisit intention.

H2a: Eco-tourist knowledge is positively related to revisit intention.

The relationship between the dependent variable (intention to return to Malaysia) and the independent variable (eco-tourist knowledge) is shown in the table above. The result of 0.612 is explained by the two variables' significant positive correlation. This reveals that many respondents believe there is a significant relationship between third variables, acceptance of eco-tourists return to Malaysia. The independent variable will therefore have an impact on the dependent variable.



### Hypothesis 3

H3o: Eco-tourist acceptance is negatively not related to revisit intention.

H3a: Eco-tourist acceptance is positively related to revisit intention.

The relationship between the dependent variable (intention to return to Malaysia) and the independent variable (acceptance of eco-tourists) is seen in the table above. The result of 0.784 can be explained by the two variables' significant positive correlation. This reveals that many respondents believe the third variables which is acceptance of eco-tourists have significant relationship to return in Malaysia. The independent variable will therefore have an impact on the dependent variable. This makes it possible to demonstrate how all independent variables are related to dependent ones.

## **DISCUSSION & RECOMMENDATIONS**

Among the problems is that many attractions are not ready to accommodate tourists due to a lack of facilities and perfect management. ecotourism destinations must be comprised of services and facilities which cater to visitor needs. According to Norlalle (2020), Tourism Malaysia has implemented various tourism promotions. However, there are a few tourists centre that do not maintain the facilities well, causing inconvenience to tourists. Ecotourism places are mostly located in remote areas and close to hills or forests with the geographical conditions of some ecotourism places that have more mountains and beaches, it is necessary to use the appropriate vehicle to reach the tourist destination.

The next problem is the deviation of tourists' perception of ecotourism. Tourists do not deeply understand the concept of ecotourism. Mostly, tourists want to do tourism activities in an environment-themed area, but they do not comply with some rules set by the authorities. The main goal of ecotourism is the process of communication with nature, granting a minimum load on ecological systems (Dzhandzhugazova et al., 2019a). There are eight basic principles that need to be followed to protect the importance of ecotourism. These include reducing the impact on the environment, minimizing the impact of development, increasing respect for the country being visited, optimizing economic profits for the country as well as increasing satisfaction for tourists.

Based on the study found that revisit intention among ecotourists is involving with three factors which is perception, knowledge, and acceptance among them. Revisit intention can

make the tourist come again to visit the ecotourism place in Malaysia if they impress with the services and facilities in that place. Great facilities and services can gain positive perception, knowledge, and acceptance among ecotourist to have better future in ecotourism fields especially in Malaysia.

## CONCLUSION

In conclusion, this research was carried out to examine the perception, knowledge, and acceptance related to the desire to visit Malaysia again in Malaysia. In addition, this study can be used as a reference by other academics who conduct studies on ecotourism attractions in Malaysia. Further research was done on the results from Chapter 4's use the results using the Social Science Statistics Package (SPSS). Based on research factors, it can be said that the factors that encourage tourists to return to ecotourism areas are awareness, knowledge and acceptance. Therefore, all the data collected for this study are expected to further increase tourist interest in traveling to ecotourism areas and benefit stakeholders to promote ecotourism in Malaysia. increase.

## REFERENCES

- Agarwal, S., Busby, G., & Huang, R. (2018). Special interest tourism: an introduction (pp. 1–17). London: *Special Interest Tourism*, CABI.
- Aswita, D., Suryadarma, I.G.P., Suyanto, S., & Herawan, T. (2020). The Natural Resources Potency Of Marine Ecotourism As An Environment Education Source. *GeoJournal of Tourism and Geosites*, 31(3), 996–1003. <https://doi.org/10.30892/gtg.31310-533>
- Azis, S. S. Ab., Sipan, I., Sapri, M., & Zafirah, A. M. (2018). Creating an innocuous mangrove ecosystem: Understanding the influence of ecotourism products from Malaysian and international perspectives. *Ocean & Coastal Management*, 165, 416–427.
- Clarke, J. A framework of approaches to sustainable tourism. *J. Sustain. Tour.* 2017, 5, 224–233.
- Damera, A. (2022, July 28). 5 Types of Research Design - *Elements and Characteristics*. EMERITUS. Retrieved December 31, 2022, from <https://emeritus.org/in/learn/types-of-research-design/>

- Dekhili, S. (n.d.). *The perception of ecotourism. Semantic profusion and tourists' expectations*. Cairn.info.
- Dzhandzhugazova EA, Ilina EL, Latkin AN, Davydovich AR, Siganova VV (2019b) *Problems of Development of Ecotourism on the Territory of National Parks of Russia. Ekoloji, 28(107): 4913-4917.*
- Dzhandzhugazova EA, Maksanova LBZh, Bardakhanova TB, Ponomareva IYu, Blinova EA (2019b) *Ecotourism Development in Russia: Analysis of Best Regional Practices. Ekoloji, 28(107): 411-415.*
- F. Berkes, *Sacred Ecology: Traditional Ecological Knowledge and Resource Management*, Taylor & Francis, Philadelphia, Pa, USA, 2010.
- Giaretta, P.; Guarino, N. Ontologies and knowledge bases towards a terminological clarification. In *Towards Very Large Knowledge Bases: Knowledge Building & Knowledge Sharing*; IOS Press: Amsterdam, The Netherlands, 2015; Volume 25, pp. 307–317.
- Gupta, G.; Chopra, P. *Eco-tourists and environment protection: A pro-environment behavioural segmentation approach*. *Amity Glob. Bus. Rev.* 2014, 9, 90–95.
- Hariato, S. P., Walid masruri, N., Winarno, G. D., Tsani, M. K., & Santoso, T. (2020). Development strategy for ecotourism management based on feasibility analysis of tourist attraction objects and perception of visitors and local communities. *Biodiversitas Journal of Biological Diversity, 21(2)*.
- J. P. Brosius, “What counts as local knowledge in global environmental assessments and conventions?” in *Bridging Scales and Knowledge Systems: Concepts and Applications in Ecosystem Assessment*, W. V. Reid, F. Berkes, T. J. Wilbanks, and D. Capistrano, Eds., pp. 129–144, Island Press, Washington, DC, 2006.
- Jaini, N., Aris Anuar, A. N., & Daim, M. S. (2012). *The Practice of Sustainable Tourism in Ecotourism Sites among Ecotourism Providers*. *Asian Social Science, 8(4)*.
- Johor Haryati Shafii, Siti Nur Isma Zura Zulika Md Jamil, Azlina Md Yassin, Haidaliza Masram & Roshartini Omar (2021). *Pengurusan Penyelenggaraan Kemudahan Infrastruktur Di Kawasan Ekopelancongan Sungai Muar Johor. Research In Management Of Technology And Business, 2(1), 651–667.*

- Lian Chan, J. K., & Baum, T. (2007). Ecotourists' Perception of Ecotourism Experience in Lower Kinabatangan, Sabah, Malaysia. *Journal of Sustainable Tourism*, 15(5), 574–590.
- Lim, J.-E. & Lee, H.R. (2020). Living as residents in a tourist destination: *A phenomenological approach*, *Sustainability*, 12, 1836.
- McCombes, S. (2021, June 7). *What Is Research Design| Types, Guide & Examples*. Scribbr. Retrieved December 7, 2022.
- Mohd Zulhafiz, S., Ibrahim, K., & Edy Tonnizam, M. (2020). Persepsi Pemimpin Tempatan dan Komuniti Kawasan Pesisir di Wilayah Iskandar Malaysia Terhadap Program Ekopelancongan Kawasan Iskandar Malaysia. *Journal of Islamic, Social, Economics and Development (JISED)*, 5(34), 10 – 21.
- Niñerola, A.; Sánchez-Rebull, M.V.; Hernández-Lara, A.B. *Tourism research on sustainability: A bibliometric analysis*. *Sustainability* 2019, 11, 1377.
- Revfine.com. (2022, November 21). *Ecotourism: What it is, Advantages & Disadvantages, Examples & More*. <https://www.revfine.com/ecotourism/>
- Ruan, B., Hsee, C. K., & Lu, Z. Y. (2018). The teasing effect: An underappreciated benefit of creating and resolving an uncertainty. *Journal of Marketing Research*. <https://doi.org/10.1509/jmr.15.0346>.
- Sustainable Travel & Ecotourism in Malaysia | Frommer's*. (n.d.). <https://www.frommers.com/destinations/malaysia/planning-a-trip/sustainable-travel-ecotourism>
- Thetsane, R. M. (2019). Local community participation in tourism development: *The case of Katse Villages in Lesotho*, *Athens Journal of Tourism*, 6(2), 123-140.
- View of Pengurusan Penyelenggaraan Kemudahan Infrastruktur di Kawasan Ekopelancongan Sungai Muar, Johor*. (n.d.). <https://penerbit.uthm.edu.my/periodicals/index.php/rmtb/article/view/1709/726>

# **The Role of Service, Restaurant Environment, Food Quality, Food Hygiene, and Food Pricing Toward Customer Satisfaction On Fast Food Restaurant.**

**Teng Hui Yi, Tengku Nur Atiqah Binti Tengku Haimi, Tengku Nurhusna Fatma Binti Tengku Utama & Tuan Nor Nazieyatulwafa Bt Tuan Wil**

**Supervisor : Dr. Ataul Karim Patwary**

*Faculty of Hospitality, Tourism and Wellness, University Malaysia Kelantan*

---

## **ABSTRACT**

This study tries to identify the customer satisfaction at fast food restaurants in Malaysia is influenced by role of service, restaurant environment, food quality, food hygiene and food pricing. The top customer satisfaction component is also examined in this study. Respondents received an online questionnaire from the researchers. The goal of this study is to examine the elements that influence patron satisfaction at fast food restaurants. Data from respondents was gathered utilising a quantitative method by approaching physically. In order to get more comprehensive results, it is advised that the study area be broadened to include several population samples in subsequent research with customer's experience in Malaysia on fast food restaurant. The sample size of this study is to distribute at least 153 data respondents. A comparable research with other variables that affect customer satisfaction in fast food restaurants might be added in order to get more accurate and trustworthy results.

**Keywords :** Service, Restaurant environment, Food quality, Food hygiene, Food Pricing and Customer Satisfaction

---

## **INTRODUCTION**

This study aims to investigate the factors that influence customer satisfaction in fast-food restaurants, such as the role of service, restaurant environment, food quality, food hygiene, and food pricing. However, the introduction to this study included several sections on the study's background, research objective, literature review, methodology, discussion, recommendation and conclusion..

The breadth and extent of the American restaurant industry affect nearly every home in the country (Andaleeb et al., 2006). According to the National Restaurant Association, the

restaurant industry, the second-largest private employer in the United States, is expected to generate sales of \$709.2 billion in 2015, have over 14 million employees, and have one million locations (NRA, 2015). Additionally, according to the NRA, the restaurant industry in the US will create 1.7 million additional jobs over the next ten years, increasing the total number of employees to 15.7 million by 2025. (NRA, 2015). Due to its size and substantial effect, the restaurant industry is examined in the current study regarding consumer satisfaction.

The 1980s witnessed a growth in casual dining establishments, making them one of the industry's most common types of restaurants (Rivera et al., 2008). This category provides upscale dining in an inviting setting at pricing lower than any fast food establishment while also providing outstanding service and fast food (Arora, 2012). Fast-service restaurants and quick casual restaurants both have similar designs. However, they focus on delivering superior culinary options and an atmosphere more appropriate for the casual dining market (Ryu et al., 2010). Because they focus on providing meals quickly and reasonably priced, fast food places are sometimes known as quick-service restaurants (Arora, 2012). The present study's focus is on the fast-food restaurant industry. Consider the current state of the fast food sector to understand it better. The fast food business has a long, colorful history and impacts many facets of our society, including politics, pop culture, and nutritional trends (Aronica, 2014).

### **OBJECTIVES OF THIS STUDY**

1. To examine the influence of service on customer satisfaction in fast food restaurant.
2. To examine the influence of restaurant environment on customer satisfaction in fast food restaurant.
3. To examine the influence of food quality on customer satisfaction in fast food restaurant.
4. To examine the influence of food hygiene on customer satisfaction in fast food restaurant.
5. To examine the influence of food pricing on customer satisfaction in fast food restaurant.

## **LITERATURE REVIEW**

### **1.1 The Relationship Between Role of Service and Customer Satisfaction**

According to Lovelock et al., (2004), restaurant service quality has recently emerged as a global research topic, with researchers and experts attempting to determine the best method of measuring or improving service quality in the food service industry from various perspectives, such as customer expectation vs. perception, managers, and service providers. A service is a transitory and intangible act or performance offered by one party to another that does not usually result in ownership of any of the factors of production. Service is classified into two types which are tangibles and intangibles. Reliability, empathy, responsiveness, competence, courtesy, credibility, security, access, and communication are the ten tangible domains of service quality. Likewise, role of food quality is thought to be an important determinant of customer satisfaction and loyalty. The satisfaction and loyalty of young customers who most likely like delicious meal options be enhanced by offering higher food and beverages. Per the research, consumers' intent to eat at a restaurant is dependent on the quality of the menu items (Kivela et al., 2000)

Recent years have seen an increase in the amount of study being done on the subject of restaurant service quality. Researchers and industry professionals are striving to ascertain the best way to gauge or enhance service quality in the food service sector from a variety of angles, including management and service provider perceptions, customer expectation, and managers' perceptions. Anything that one person can do for another that is essentially immaterial and doesn't lead to the acquisition of property. Its creation may or may not be connected to a tangible good (Dudovskiy et al., 2012). Service is classified into two types which are tangibles and intangibles. Reliability, empathy, responsiveness, competence, courtesy, credibility, security, access, and communication are the ten tangible domains of service quality

### **1.2 The Relationship Between Restaurant Environment and Customer Satisfaction**

Restaurant environments are created by social influences, including traditions, conventions, social trends, values, and societal expectations of businesses. The word "fast meals" certainly doesn't have a single, agreed definition. It can be interpreted broadly and

informally to describe meals that are prepared quickly and supplied upon request (Ali et al., 2016). Fast meals are frequently preferred over dishes made at home because of the quick pace of modern life, simple access to fast food, and increased exposure to its marketing and promotion. Fast food is frequently higher in calories, fat, and sugar. It might be challenging to define fast food or take-away food establishments. Many studies and policies in this field solely take particular items into account.

The physical environment's excellence both satisfies and draws in new consumers. Restaurant surroundings increase revenue and provide patrons a memorable dining experience. Customers evaluate a restaurant's quality based on its cleanliness, unique, inviting ambience, environmental quality, and other ambience-creating features (Adam et al., 2015). In service sectors like restaurants, the influence of physical environment quality on behaviour may be observed.

### **1.3 The Relationship Between Food Quality and Customer Satisfaction**

According to Boo et al., (2012), consequently, food quality is thought to play a vital impact in determining customer experience and loyalty. By delivering enhanced food and beverages, businesses may improve early adolescents' satisfaction and loyalty as they most probably prefer delicious meal possibilities. In accordance with the research, a restaurant's capacity to draw customers is contingent on the quality of its menu items. Food quality is critical for maintaining and increasing profits by ensuring customer satisfaction.

Food quality is seen as a crucial component of the total dining experience. The most crucial consideration when choosing a restaurant is the food, which has a direct impact on patron pleasure. Customers rate restaurants depending on the quality of the cuisine, and this determines their loyalty to such establishments. The calibre of the cuisine has an impact on diners' decisions to return to a restaurant (Jin et al., 2012).

### **1.4 The Relationship Between Food Hygiene and Customer Satisfaction**

Food hygiene, also known as food safety, that defined as handling, making preparations, and storing food or beverages in a manner that reduces the risk of foodborne diseases (Kamboj et al., 2020). The food safety chain begins with raw materials and ends with finished



products, with challenges such as microbial, chemical, physical, personal, and on-site hygiene (Fung et al., 2018).

According to Hwansuk et al., (2010), there are two primary categories of this study determining the selection characteristics and their amount of influence on the customer's choice in the restaurant between hygienic and non-hygienic. A restaurant's infrastructure, equipment, silverware and, and food quality are all considered hygienic considerations. Pricing, menu selection, cuisine kind, atmosphere, convenience, location, friendliness of the employee, operation hours, and service are non-hygienic criteria. A restaurant's infrastructure, equipment, silverware and dishes, staff, and food quality are all considered hygienic considerations (Hwansuk et al., 2010).

### **1.5 The Relationship Between Food Pricing and Customer Satisfaction**

Price is "what the buyer paid to receive the product or services." According Zeithaml (1985). Offering fair rates and deals might help a restaurant get a competitive edge over its competitors. Through price, consumers determine the worth of a good or service. The pricing would draw them in and inform them of the value of the item or service. Customers anticipate fast food businesses to have cheap for moderate prices. Therefore, this factor is crucial and could convince them to choose fast food over alternative options.

One of the significant factors that affect consumer happiness is known to be pricing (Saxena et al., 2020). Price is an antecedent of consumer pleasure. Recent research on fast food businesses shows that the price considerably benefits consumer happiness. Additionally, the cost or value for money while purchasing fast food helps consumer satisfaction. According to Qin & Prybutok (2008), pricing does not significantly affect consumer satisfaction in fast-food restaurants. Fast food meals are considered less expensive than other eateries, making them negligible, even if the results are conflicting.

### **Conceptual Framework**

This framework can also be used to describe the relationship between independent and dependent variables in research. Figure 1 depicts the conceptual framework for this study. The researcher in this study will use the figure to determine the relationship between independent and dependent variables.

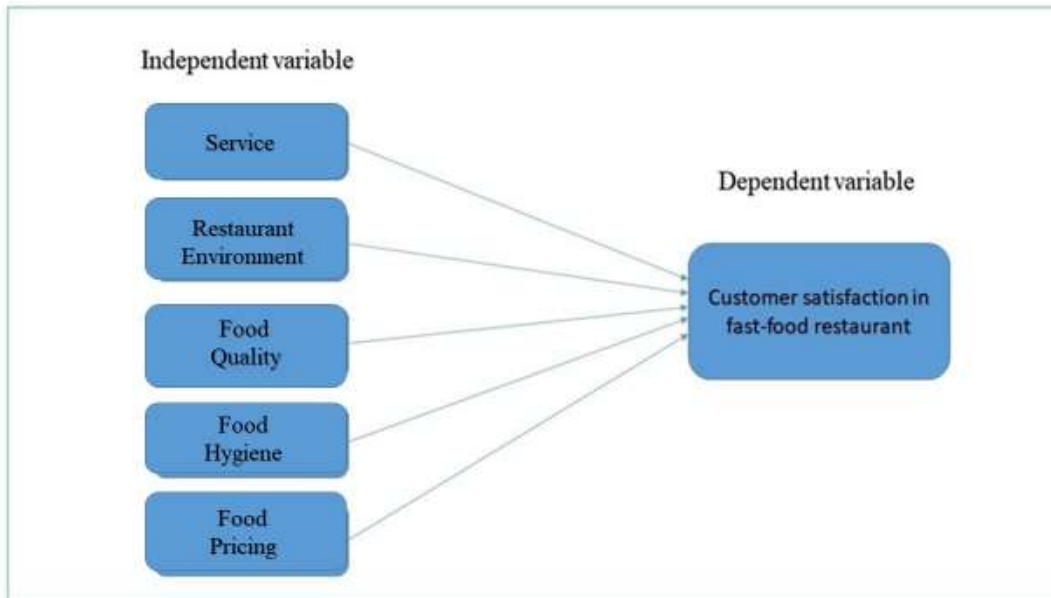

**Figure 1 : Conceptual Framework**

## **METHODOLOGY**

### **Research Design**

A research design's objective is to make sure that the data collected enables you to address the research topic as clearly and efficiently as feasible quantitative. Data will gather using a quantitative research approach in order to properly accomplish the study's goal. It included implementing the survey technique, which will use to gather statistical data about the subjects. As permitted by the subject, information was only gathered once at each place, which is dispersed throughout the fast food restaurant in Malaysia.

### **Population**

In this study, the researcher's target population will focus on customers in Malaysia who make purchases at fast food restaurants. Based on the sample size and sampling method, researcher will collect data and information about customer satisfaction by approach. So, the total population for number of adult Malaysian are 22.73 million.

### **Sample Size**

For this research, the study sample consisted of customer satisfaction on fast food restaurants in Malaysia. This survey will be carried out at random among the people in Malaysia. Therefore, it is crucial to make sure that the sample size chosen for this study is sufficient to produce precise and trustworthy data. For the purpose of obtaining a proper

sample size, this study employed the table created by Krejcie and Morgan Table (1970). Therefore, 384 respondents will be recruited from selected customer experience to provide an appropriate level of confidence for the study. However, the researcher needs to collect data from at least 153 respondents

### **Sampling Technique**

In this part, researcher will use convenience sampling for complete the research. Convenience sampling are a group of samples are selected from the population only. This is because it will be more easy for collecting the data and handling by the researcher. But it cannot represent all whole group of population. The advantages of convenience sampling are saving more time, save money, easy for available and information can be more and specific.

### **Data Collection Procedure**

Primary data source is a questionnaire in which respondents tick the questions they believe are relevant. In quantitative method, the researcher will use the primary data to collect the information from respondents. The questionnaire is being distributed to all people or customer in Malaysia regarding their satisfaction with fast food restaurants. So, the researchers may print out the questions to pass to the respondents.

### **Instrument**

The questionnaire will be divided into three sections. For the section A is consists of the demographic, section B is about the consideration of the factor, and section C is to see how the relationship between the factors. To measure the independent variable and dependent variable the questions will be adopted from previous studies. The first measurement that is being used is nominal scale, which is used for labelling variables without any quantitative value. The second measurement that is being used is ordinal scale, rating scales is the method that use to measure the statements in the questionnaire such as Likert scale. For simplicity, the questionnaire is used Five-Point Likert scale as the structure for both independent variables and dependent variable.

### **Data Analysis**

After the data collection completed, all the data gather will be analysed using by the IBM Statistical Package for Social Science (SPSS). The analyses procedure for the research is divided into three procedures; descriptive statistics, reliability test and Pearson Correlation.

## FINDINGS

### Result of Frequency Analysis

Table 1 : Result of Demographic Analysis

Characteristics		Frequency	Percentage (%)
Gender	Male	44	28.8
	Female	109	71.2
Age	18 – 22	32	20.9
	23 – 27	84	54.9
	28 – 32	12	7.8
	33 – 37	13	8.5
	38 – 42	6	3.9
	43 and above	6	3.9
Race	Malay	32	86.3
	Chinese	19	12.4
	Others	2	1.3
Marital Status	Married	38	24.8
	Single	115	75.2
Occupation	Government Sector	14	9.2
	Public Sector	18	11.8
	Self-employed	30	19.6
	Student	91	59.5
Educational Level	SPM	16	10.5
	STPM	13	8.5
	Diploma	26	17.0

	Degree	94	61.4
	Master	3	2.0
	PhD	1	0.7
Monthly Income	Less than RM 1500	115	75.2
	RM 1501 – RM 3500	29	19.0
	RM 3501 – RM 5500	0	0
	RM 5501 – RM 7500	3	2.0
	RM 7501 – RM 9500	4	2.6
	More than RM 10000	2	1.3

Table 1 show that the gender of female got more percentage for this study which is 71.2% due to 109 questionnaires while male get 44 respondents with 28.8%. Next, the most significant percentage of questionnaire for this study is age group of 23 to 27 years with 54.9%. Following that, the age group of 18 to 22 years with 32 (20.9%). In addition, there were 32 questionnaires that filled out by Malay people. Its mean that are they making up majority with 86.3% and followed by Chinese with 19 (12.4%) and other with 2 (1.3%). Furthermore, according the result, total of 94 respondents possessed a Degree. This group responded to the most questionnaires with percentage of 61.4%. Following that, 26 persons with a Diploma completed this questionnaire with 17.0%.

For occupation, the student had the highest response which is 91 questionnaires due to 59.5%, followed by self-employed with 30 respondents (19.6%) and public sector with 18 (11.8%). Lastly, for the overall monthly income of all respondent who filled out the questionnaire, a total of 115 with 75.2% of those questioned were less than RM 1500. This is the highest group in terms of total respondents, followed by 29 respondents have filled out the questionnaires regarding monthly income of RM 1501 to RM 3500. This shows a percentage of 19.0% and it is in the second highest place.

Table 2 : Result for Reliability Analysis

Item Description	N	No. of Items	Cronbach's Alpha
Service	153	4	0.913

Restaurant Environment	153	5	0.926
Food Quality	153	3	0.910
Food Hygiene	153	4	0.898
Food Pricing	153	4	0.948
Customer Satisfaction	153	3	0.942

The study examines the reliability of various variables, including service, restaurant environment, food quality, food hygiene, food pricing, and customer satisfaction. The Cronbach's Alpha results show inconsistent internal consistency (0.9), possibly due to researchers improving questionnaire tools and questions. The restaurant environment has low internal consistency (0.9), possibly due to respondents' ethnicity or diverse backgrounds. Food quality has acceptable internal consistency, while food hygiene has good internal consistency, with respondents being the only reliable source of information. Food pricing has four elements with a Cronbach alpha of 0.948, and customer satisfaction has three elements with a Cronbach alpha value of 0.948. Overall, the study is considered reliable, with low stability, and the overall reliability test is excellent at 0.980.

### Result of Inferential Analysis (Correlation Analysis)

Table 3 : Relationship of Restaurant Attribute on Customers Satisfaction

		SE	RE	FQ	FH	FP	CS
SE	Pearson Correlation	1	.742 <sup>*</sup>	.854 <sup>*</sup>	.812 <sup>*</sup>	.836 <sup>*</sup>	.826 <sup>*</sup>
	Sig. (2-tailed)		.000	.000	.000	.000	.000
	N	153	153	153	153	153	153
RE	Pearson Correlation	.742 <sup>*</sup>	1	.799 <sup>*</sup>	.839 <sup>*</sup>	.734 <sup>*</sup>	.781 <sup>*</sup>
	Sig. (2-tailed)	.000		.000	.000	.000	.000
	N	153	153	153	153	153	153

FQ	Pearson Correlation	.854*	.799*	1	.850*	.881*	.883*
	Sig. (2-tailed)	.000	.000		.000	.000	.000
	N	153	153	153	153	153	153
FH	Pearson Correlation	.812*	.839*	.850*	1	.806*	.839*
	Sig. (2-tailed)	.000	.000	.000		.000	.000
	N	153	153	153	153	153	153
FP	Pearson Correlation	.836*	.734*	.881*	.806*	1	.894*
	Sig. (2-tailed)	.000	.000	.000	.000		.000
	N	153	153	153	153	153	153
CS	Pearson Correlation	.826*	.781*	.883*	.839*	.894*	1
	Sig. (2-tailed)	.000	.000	.000	.000	.000	
	N	153	153	153	153	153	153
**. Correlation is significant at the 0.01 level (2-tailed).							

Table 3 shows the association between customer satisfaction and independent variables such as service, restaurant environment, food quality, food hygiene, and food pricing. Service has a strong positive correlation with customer happiness, while the restaurant environment affects satisfaction. Meal quality is crucial for customer pleasure, and food hygiene has a strong correlation with satisfaction. Food pricing is also strongly correlated with satisfaction, with many respondents believing it strongly correlates with customer satisfaction.

## Framework Analysis

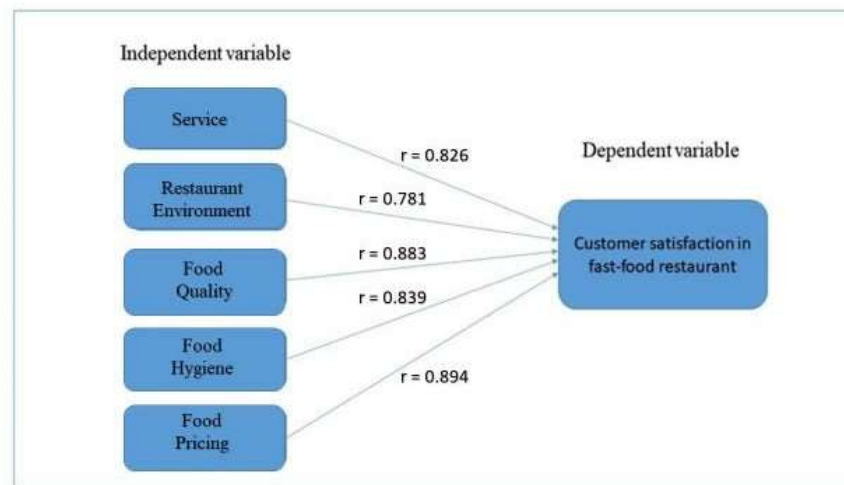

Figure 2 : Correlation between service, restaurant environment, food quality, food hygiene, food pricing and customer satisfaction in fast food restaurant

Figure 2 shows that customer satisfaction is significantly related to five independent variables: service, restaurant environment, food quality, food hygiene, and pricing. Food pricing has the highest Pearson correlation, followed by food quality, food hygiene, service, and restaurant environment. These factors are crucial for customer satisfaction in fast food.

## DISCUSSION AND RECOMMENDATION

The researcher will provide some suggestions in this area to enhance subsequent study. These recommendations are meant to improve the calibre of study findings and help students get hired by fast food chains.

In the current study, the researcher focused on five variables: service, restaurant environment, food quality, food hygiene, and food pricing (independent variable), and customer satisfaction in fast food restaurant (dependent variable). A moderately positive correlation between the independent and dependent variables was found by the findings. Future studies could investigate the addition of various independent factors to produce novel findings to progress the discipline. All generations still enjoy eating fast food. The study looks at elements that affect patrons' satisfaction with fast food restaurant services. If respondents prefer to dine at fast food restaurants, further research might look into it.



Limitation that are face by researcher are not all Malaysian will be willing for giving the time and energy for answering it. Only youngsters will cooperate for giving back the feedback to this study. While other respondent thinking it was a wasting time activity. Moreover, the information has a high similarity. This is because they are sharing a same viewpoint in this study. Lastly, ways of the respondent getting the data also one disadvantages. Some fast-food restaurant's location are not specific which make researcher failure for getting respondent for answering the question of this study.

Recommendations are what is the suggestion that can be improved in this study. Firstly, searching more respondent for getting more authentic information to improve the report. Secondly, define the meaning of the review and rewrite it. Each terms have a different meaning and explanation on it. Lastly, doing more research about the background of the respondent. Respondent that are answering the question of the study have different religion, races and states. Researcher will getting more accurate result or information for completely the report.

## **CONCLUSION**

This chapter comes to a close with an analysis of all the variables in relation to fast food establishments, which reveals a strong correlation. This demonstrates that these factors have an impact on how much fast food is consumed by students. The identified variables were subjected to descriptive analysis, reliability testing, and correlation analysis before being accepted for this study. Even though it is restricted to online and in-person research, it facilitates data collection. Finally, the suggestions made in this chapter will be valuable for further research in this area.

## REFERENCES

- Adam I, Adongo CA, Dayour F (2015) International tourists' satisfaction with Ghanaian upscale restaurant services and revisit intentions. *J Q Assur Hosp Tour* 16(2):181-201
- Akter, M., Sadekin, M. N., & Patwary, A. K. (2020). An Empirical Study on Students' Satisfaction from Mawlana Bhashani Science & Technology University, Bangladesh. *Review of Economics and Development Studies*, 6(2), 363-379.
- Ali F, Amin M, Ryu K (2016) The role of physical environment, price perceptions, and consumption emotions in developing customer satisfaction in Chinese resort hotels.
- Alom, S., Patwary, A. K., & Khan, M. M. H. (2019). Factors affecting the turnover intention of Bangladeshi migrants in the United Arab Emirates: An empirical study on the hotel industry. *International Journal of Innovation, Creativity and Change*, 8(3), 344-360.
- Andaleeb, S., & Conway, C. (2006). Customer satisfaction in the restaurant industry: an examination of the transaction-specific model. *Journal of Services Marketing*, 20(1), approach.
- Aronica, M. (2014). Where your favorite fast-food chains began. Retrieved from <http://www.usatoday.com/story/travel/destinations/2014/05/31/fast-foodchainsorigins/9729901/>
- Boo, H, V.(2012)*Role of Service Environment for Restaurants:The Youth Customer's*
- Dudovskiy, J. (2012, June 25). Customer service satisfaction - Research Methodology. Retrieved from Research-Methodology website: <https://research-environment.com/>
- Fengmin, Z., Baijun, W., Jiangtao, B., Li, L., & Patwary, A. K. (2022). Investigating revisit intention of medical tourists in China through nutritional knowledge, perceived medical quality, and trust in the physiologist: A recommendation on health tourism policy measures. *Frontiers in Public Health*, 10, 893497.
- Hazbar, A. M. H., Alem Mohammed, A., & Karim, A. K. A. (2019). An Empirical Study of Factors Influencing hotel customers' online booking Intention. *مجلة العلوم التربوية و الإنسانية الدراسات*, (5), 1-17. [https://www.researchgate.net/publication/257715736\\_Role\\_of\\_Service\\_Environment\\_for\\_Restaurants\\_The\\_Youth\\_Customers'\\_Perspective](https://www.researchgate.net/publication/257715736_Role_of_Service_Environment_for_Restaurants_The_Youth_Customers'_Perspective)
- Hwansuk Chris, C., MacLaurin, T., Cho, J.-E., & Hahm, S.-P. (2010). Food Hygiene International Journal of Public Sector Performance Management, 6(4), 456-466.
- Jin N, Lee S, Huffman L (2012) Impact of restaurant experience on brand image and customer loyalty: moderating role of dining motivation. *J Travel Tour Mark* 29(6):532–551
- Kivela, J., Inbakaran, R., & Reece, J. (2000). Consumerresearch in the restaurant
- Li, L., Ragavan, N. A., Patwary, A. K., & Baijun, W. (2022). Measuring patients' satisfaction toward health tourism in Malaysia through hospital environment, nutritional advice, and perceived value: A study on Chinese exchange students. *Frontiers in public health*, 10, 893439.
- Li, L., Wu, B., & Patwary, A. K. (2022). How marine tourism promote financial development in sustainable economy: new evidences from South Asia and implications to future tourism students. *Environmental Science and Pollution Research*, 29, 1155-1172.

- Li, L., Wu, B., & Patwary, A. K. (2022). The psychosocial factors affecting chinese Outbound Exchange and mobility students' academic performance during COVID-19. *Frontiers in psychology*, 13, 872516.
- Lovelock, C., & Gummesson, E. (2004). Whither Services Marketing? In Search of a New methodology.net/customer-satisfaction/
- Paradigm and Fresh Perspectives. *Journal of Service Research*, 7, 20-41. <https://doi.org/10.1177/1094670504266131> Part 3: Analysis, findings and conclusions. *International Journal of Contemporary Hospitality Management*, 12(1), 13-30.
- Patwary, A. K., Roy, B., Hoque, R., & Khandakar, M. S. A. (2019). Process of developing a community based tourism and identifying its economic and social impacts: An Empirical study on Cox's Bazar, Bangladesh. *Pakistan Journal of Humanities and Social Sciences*, 7(1), 1-13.
- Qin, G., & Prybutok, V. R. (2008). Determinants of customer-perceived service quality in fast- food restaurants and their relationship to customer satisfaction and behavioral intentions. *Quality Management Journal*, 15(2), 35–50.
- Rivera, M., DiPietro, R. B., Murphy, K. S., & Muller, C. C. (2008). Multi-unit managers: Training needs and competencies for casual dining restaurants. *International Journal of Contemporary Hospitality Management*, 20(6), 616-630.
- Ryu, K., & Han, H. (2010). Influence of the quality of food, service, and physical environment on customer satisfaction and behavioral intention in quick-casual restaurants: Moderating role of perceived price. *Journal of Hospitality & Tourism Satisfaction of Singaporean Diners. Journal of Foodservice Business Research*, 13(3), 156–177. <https://doi.org/10.1080/15378020.2010.500225>
- Saxena, N., & Taneja, M. (2020). Youth preferences for fast food industry: a conjoint sensual delight in dining experience. *Journal of Consumer Marketing*, 29(5), 333-343.
- Sumethokula, P., Patwary, A. K., Srinuanpanc, B., Srinuanpand, C., Suwandee, P., Thammathikul, A., & Phanong, W. (2020). The potential of new tour repackaging for creative tourism among entrepreneurs in Nakhon Si Thammarat. *International Journal of Innovation, Creativity and Change*, 13(10), 1752-1771.
- Wu, B., Liu, S., Wang, J., Tahir, S., & Patwary, A. K. (2021). Assessing the mechanism of energy efficiency and energy poverty alleviation based on environmental regulation policy measures. *Environmental Science and Pollution Research*, 28, 40858-40870.
- Wu, B., Zhai, B., Mu, H., Peng, X., Wang, C., & Patwary, A. K. (2021). Evaluating an economic application of renewable generated hydrogen: A way forward for green economic performance and policy measures. *Environmental Science and Pollution Research*, 1-15.
- Zeithaml, P. A. (1985). A conceptual model of service quality and its implication for future research. *Journal of Marketing Research*, 49 (Fall), 41-50.

# The Role of Customer Attribute On Customer Satisfaction Toward Restaurant In Kelantan

Umi Najwa Izzati Binti Aziz Jaffar, Wafa Binti Abdul Rahim, Wan Nur Alia Binti Wan Hasri & Yasmin Raihana Binti Razali

\* Nur Ida Fatimah Bt Che Shalifullizam

*Faculty of Hospitality, Tourism, and Wellness, University Malaysia Kelantan*

*Corresponding email: [h20a1855@siswa.umk.edu.my](mailto:h20a1855@siswa.umk.edu.my)*

## Abstract

---

*The determination of this study is about the factor influencing customer satisfaction to the restaurant which is the role of food safety, online review, attitude of restaurant staff, and cleanliness on customer satisfaction among restaurants in Kelantan. Various issues are encountered in restaurant management with regard to customer service in order to ensure customer satisfaction to convert customers into returning customers, we need to give them satisfaction that is, make sure they are happy and always offer them a perfect experience. The objective of this study is to examine the role of food safety, the attitude of restaurant staff, online reviews, and cleanliness on satisfaction among customers in Kelantan. Data will be collected through a questionnaire survey using convenience sampling and will be analyzed by the IBM Statistical Package for Social Science (SPSS). The findings of this study will indicate the customer attribute that focuses on food safety, the attitude of staff, online reviews, and cleanliness as the key decision variables used for customer satisfaction toward restaurants in Kelantan.*

**Keywords:** Food Safety, Online Reviews, Attitude of Restaurant Staff, Cleanliness

## INTRODUCTION

Based on an assessment of the relationship between customer expectations and product or service delivery, customer satisfaction was long examined as a one-dimensional notion (Susskind et al., 2018). On the contrary, in the harsh hospitality sector, client happiness has emerged as a crucial element of corporate strategy (Chun & Nyam, 2020). Numerous academics have investigated consumer happiness in the travel, tourism, and food and beverage (F&B) sectors (Uslu & Eren, 2020). Like other industries, the food service sector has also seen a significant rise in the importance of customer happiness as a business concern. Today, in a world where competition is fierce, maintaining a competitive advantage requires offering top-notch customer service (Mmutle & Shonhe, 2017). Additionally, a good balance between the tangible, such as the food and physical facilities, and the intangible, such as the interaction between

employees and customers, are some factors that should affect how customers perceive the quality of restaurant service, resulting in customer satisfaction and constructive behavioral intentions in the restaurant industry (Hussein, 2018).

The food, ambiance, and services at the fancy restaurants (Paulose & Shakeel, 2021), and customers are willing to spend more for these upmarket amenities and exceptional offerings (Gupta et al., 2022; Paulose & Shakeel, 2021). Physical characteristics are very crucial for restaurant establishments. Customers can have a suitable distance between them at tables, for instance, and artwork like paintings can assist create a certain vibe (Elite, 2017). It is impossible to overstate the value of the restaurant's menu. Before opening for business, a restaurant should decide on a solid menu selection and create the menu itself. The restaurant's physical structure, interior design, and service philosophy are all held together by the

menu, which also, and perhaps more crucially, shapes how diners view the establishment. Customers' opinions of the restaurant and their spending at the restaurant may be impacted by the menu's layout and style, order of food items, and level of detail (Schjll & Alfnes, 2017).

Many firms in the restaurant sector use this paradigm to forecast the effectiveness of employee development programs, especially those that deal with the safe handling of food (Food Safety Magazine eDigest (FSME), 2018; National Restaurant Association, 2017). Farmers, food transportation companies, food suppliers or vendors, and restaurants, to name a few, are all equally responsible for making sure that staff members obtain the necessary training and have the tools they need to perform professions involving the safe handling of food (FDA, 2018). To meet requirements for safe food handling and maintain a sanitary workplace, restaurants are required to interact with local health officials. This is done to protect the public's safety. The Food and Drug Administration (FDA) (2017) recommends that the criteria be based on the Food Code, but agencies have the freedom to create their own review rules, forms used during inspections, and particular criteria that meet or exceed the requirements stated in the Food Code. A restaurant's operating license must be maintained in accordance with these requirements, and employee training must be planned to fulfill the inspection requirements set forth and compulsory by local health officials (Food and Drug Administration (FDA), 2017).

User-generated online reviews are becoming more and more common since they can affect service businesses' business performance and service revolution in addition to customers' product/service evaluations and purchase decisions (Yang et al., 2017). Online hotel and restaurant review sites like Trip Advisor and Yelp are regarded as trustworthy sources of information about products and services

that have developed with customer social involvement over the past ten years (Kesgin & Murthy, 2019). However, recent studies have shown that businesses and customers publishing online reviews can risk the legitimacy and openness of these review platforms, posing serious problems for businesses, customers, and review platforms themselves (Lo & Yao, 2019).

The purpose of this research study is:

1. To examine the role of food safety on satisfaction among customers in Kelantan.
2. To investigate the influence of online reviews on satisfaction among customers in Kelantan.
3. To identify the role of the attitude of restaurant staff on satisfaction among customers in Kelantan.
4. To determine the role of cleanliness on satisfaction among customers in Kelantan.

### **Significant of the Study**

At the end of this research, it will support us better understand how to meet customer satisfaction through food quality, online reviews, the attitude of restaurant staff and cleanliness, and how to get that quality. The researchers are trying to identify whether food safety, online reviews, the attitude of restaurant staff, and cleanliness effect on customer satisfaction. This study is able to provide benefits and knowledge to the food and beverage community and all individuals involved in business hospitality. This will be able to help others to meet customer satisfaction by using the information from this study. This study can also provide new findings and help restaurant operators know about food safety, online reviews, the attitude of restaurant staff and cleanliness can affect customer satisfaction in fine dining restaurants in Kelantan.

## **LITERATURE REVIEW**

### **Food Safety**

Food handling, processing, and distribution procedures are referred to as "food safety" to ensure that there are no contaminants present that could cause food-borne illnesses. Food safety mentions to the proper food management methods used during food preparation, processing, storage, and circulation when you work with products in the food industry. Customers frequently worry about the safety of the food when dining out. The safety of a restaurant was evaluated based on the following factors: staff presentation, observed cleanliness, inspection results, and overall impression. Customers, particularly in developed nations, have become picky about the food products they purchase; they prefer fresh, healthy foods that need to be handled properly from production through ingesting (Moslehpour et al., 2014; Savelli et al., 2017). The most fundamental standard for assessing food quality is food safety. Additionally, the cleanliness of the restaurants reflected the quality of the food being served. They also based their choice to go back to the restaurant on these various factors. Functional, mechanical, and human clues were proposed as three indicators to evaluate restaurant cleanliness and diners' dining experiences in earlier literature. Food temperature and freshness are relevant functional clues. These hints are essential to ensuring client satisfaction and a company's viability.

### **Online Reviews**

Since the invention of the Internet, consumers have used online platforms more frequently. Customer satisfaction is frequently well-defined as a client's general opinion of the caliber of a service or product. Before buying a good or service, customers frequently read numerous

reviews (Thomas et al., 2019). Reviews, in particular, frequently disclose details about the caliber of the service and the safety of the food, allowing potential customers to more accurately predict their own upcoming experiences based on the experiences of others who have used the service or purchased the invention (Beneke et al., 2016). While factors influencing the usefulness of reviews have been discussed in previous research on online product review content (Hong et al., 2017), as well as how analysis of textual content can be used to predict product ratings (Lei et al., 2016), there has been relatively little research on how the online of custom review affect customers.

### **Attitude of Staff Restaurant**

Service value is one of the big issues that will affect all businesses. Among the service quality that is meant is employee attitude towards the customer. The success of businesses in the hospitality sector can be directly impacted by motivating frontline staff to deliver high-quality customer service (Chen et al., 2017). Employees are inconvenienced by problematic, annoying, or rude customers. On the other hand, a cheerful and enthusiastic attitude is more prospective to produce courtesy, emotional involvement, and sincere concern for the happiness and well-being of customers. From the restaurant context, good behavior or treatment from employees will have a good effect on customer satisfaction.

### **Cleanliness**

Cleanliness of service environments plays a significant role in determining general customer satisfaction, perceived service quality, and customer intention to use a particular service provider again (Pizam & Tasci, 2018). The FDA Food Code provides guidelines for restaurant cleaning. According to the FDA Food

Code, sanitization is necessary for surfaces that originate into contact with food and should be cleaned thoroughly in restaurants. According to the FDA Food Code, "sanitization" is as follows: (FDA, 2017). According to research on restaurant cleanliness, Chow et al. (2019) discovered that customers' satisfaction was significantly impacted by a customer's expectation of cleanliness. Cleanliness is an important analyst of customer satisfaction. Customers are more likely to make additional purchases when they are pleased with the performance of a product or service because it meets their expectations.

### **Customer Satisfaction**

Customer satisfaction is a crucial business concern because business owners have discovered that receiving favorable client feedback is necessary for a long-term sustainable operation. If a restaurant's patrons have a wonderful dining experience, they might recommend it to others, come back often, or both. Customer satisfaction is a crucial business concern for restaurants, just like it is in other sectors. Restaurants want customers to have the best experience possible to increase the likelihood that they will return. Positive customer feedback is crucial for creating a long-term sustainable company, entrepreneurs have discovered (Chun & Nyam-Ochir, 2020). In order to avoid product contamination, cleanliness is

crucial in the food sector. Production is safer in a clean environment since there is less chance of cross-contamination between products or contamination from raw materials.

### **Research Hypotheses**

The following hypothesis was developed and was to be tested based on the study:

H1: Food safety is positively related to customer satisfaction.

H2: Online review is positively related to customer satisfaction.

H3: Attitude of restaurant staff is positively related to customer satisfaction.

H4: Cleanliness is positively related to customer satisfaction.

### **Research Framework**

Figure 1 below had shown the conceptual framework of this study. Customer satisfaction toward restaurants in Kelantan was the dependent variable in this research while food safety, online review, attitude, and cleanliness were the independent variables of this research of study. The figure below had shown a linkage of the relationship between the independent variables and the dependent variable.

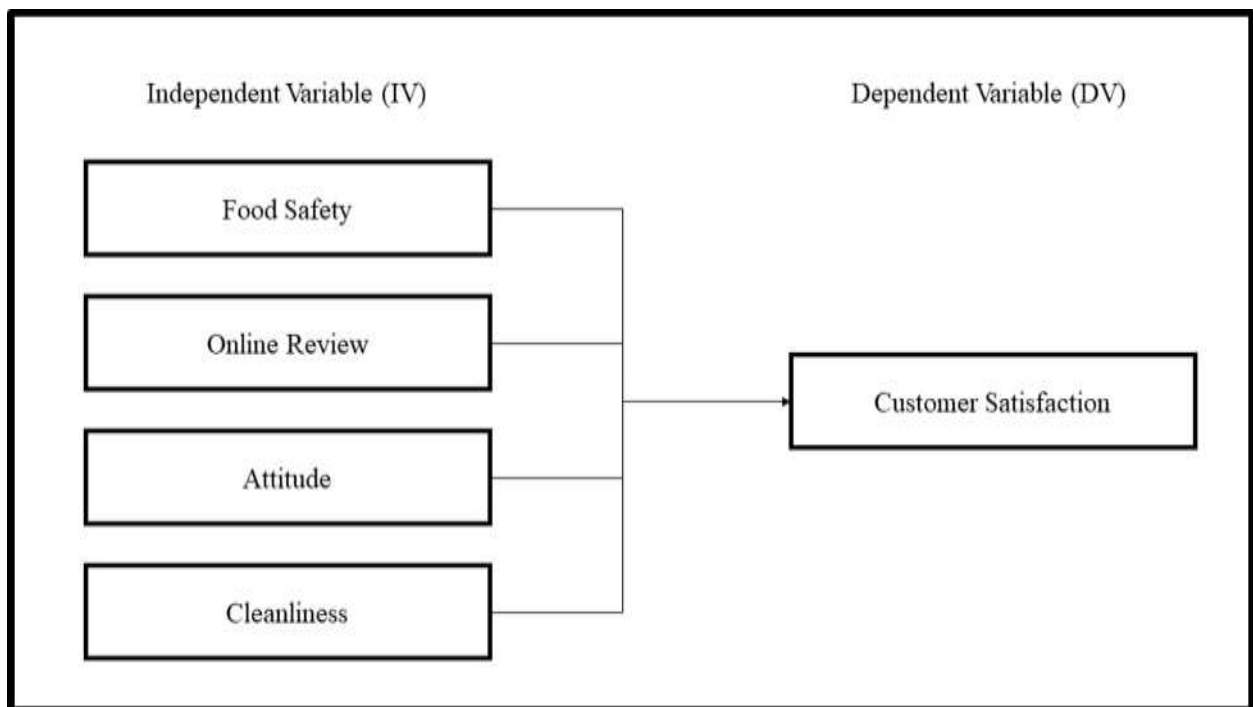

Figure 1 Relationships between the Independent Variables and Dependent Variable

Sources : Food Safety (Mekimah & Sayad, 2020); Online Review (Bi et al., 2019) ; Attitude (Ribeiro & Prayag, 2019); Cleanliness (Pizam & Tasci, 2018).

## METHODOLOGY

### Research Design

For this study, the researcher will use a quantitative method. Every organization needs quantitative analysis to design ways to grow. The population that the researcher will use in this study is customers in Kelantan. Population mentions to the entire group of people who share particular traits and characteristics. The population can be thought of as the study's intended audience or community of individuals who share the same trait. The process of selecting a statistically representative sample of people from an interested population is known as sampling. This study is being carried out in Kelantan and the researchers are choosing customers who currently there to take some time to answer the survey. This survey takes about 229 out of 384 customers.

### Data Collection

Quantitative research was chosen for this research. This research survey used a self-service data collection mode, where respondents were asked to complete the questionnaire themselves. A total of 384 respondents will be selected to answer the questionnaire in person. They will be given an online questionnaire. After the respondents agree to fill out the questionnaire, the researcher will explain the questionnaire to them. Respondents have no obligation or compulsion to complete the research questions provided. The questionnaire emphasizes the intention of the study, and the goal of the study, and acknowledges the confidentiality of the respondent's information.

### Sampling

In this study, the researchers selected non-probability sampling techniques which are convenience



sampling technique because it is used to select a predetermined number of respondents and very easy to reach them. This study sample is customers who have been to the restaurant. Researchers choose convenience sampling at few restaurants in Kelantan.

### Data Analysis

This study uses four data analysis types which are descriptive statistics, reliability statistics, and Pearson's correlation. The data obtained were analysed by using SPSS version 25. The use of SPSS in the study helps to achieve the research objectives and helps to process the data that has been obtained.

## FINDINGS

Table 1: Demographic Analysis

Item	Frequency (n)	Percentage (%)
<b>Gender</b>		
<i>Male</i>	171	52.0
<i>Female</i>	158	48.0
<b>Age Group</b>		
<i>18-21 years old</i>	46	14.0
<i>22-25 years old</i>	248	75.4
<i>26-29 years old</i>	19	5.8
<i>30 years old and above</i>	16	4.9
<b>Race</b>		
<i>Chinese</i>	30	9.1
<i>Indian</i>	15	4.6
<i>Malay</i>	282	85.7
<i>Others</i>	2	0.6
<b>Status</b>		
<i>Married</i>	27	8.2

<i>Single</i>	302	91.8
<b>Occupation</b>		
<i>Employed</i>	135	41.0
<i>Others</i>	3	0.9
<i>Student</i>	186	56.5
<i>Unemployed</i>	5	1.5
<b>Total</b>	<b>329</b>	<b>100</b>

The totals of 329 respondents which are 100% were Malaysian food consumers. The majority of the respondents 52.0% were male. It is because men prefer to eat at restaurant since it is more convenient and faster. Women eat less at restaurants because they prefer to prepare their meals at home. In the sample, 75.4% were in the 22-25 years old age bracket. People between the ages of 22 and 25 prefer to dine at restaurants since they are already aware of the aspects that can provide them with satisfaction as restaurant consumers. 85.7% were Malay. It is because when compared to other races, the majority of people in Kelantan are Malays. 91.8% were single and 56.5% were students. The majority of single persons will eat in restaurant. This is because they believe that eating in restaurant is preferable to cooking at home. It can help to save time and energy. Because most students are unable to cook, they dine at restaurants. They are unable to cook because they are students. For example, the university may not permit cooking in the college or may not have culinary equipment.

**Table 2: Descriptive Analysis**

<b>Variable</b>	<b>Items</b>	<b>Mean Score</b>	<b>Standard Deviation</b>
<b>Food Safety</b>	Serving utensils are clean.	4.69	0.62
	Restaurant serves food at the appropriate temperature (i.e., hot food hot and cold food cold).	4.59	0.66
	Restaurant uses fresh ingredients (i.e., no off-flavor or off-color foods).	4.56	0.78
	Tableware is clean.	4.59	0.67
	Restaurant provides information about ingredients and food allergy	4.36	1.09
<b>Online Reviews</b>	I believe that online customer reviews are informative.	4.61	0.74
	I will search for information about the restaurant after reading online customer reviews.	4.52	0.76
	Customer online reviews help me to compare restaurant.	4.58	0.76
	I think the restaurant is worth trying after reading the online customer reviews.	4.55	0.73
	The online review makes me confident in picking the restaurant.	4.57	0.76
<b>Attitude of Staff Restaurant</b>	The staff can handle customer's special needs effectively.	4.57	0.58
	The staff can accommodate customer complaints professionally.	4.61	0.60
	The staff has effective communication skill.	4.61	0.61
<b>Cleanliness</b>	Restaurant cleanliness is important to me evaluating overall restaurant quality.	4.85	0.39
	A dirty restaurant will decrease my overall level of satisfaction.	4.80	0.42
	A clean restaurant will increase my overall level of satisfaction.	4.83	0.38
	I high expectations of cleanliness for high-budget restaurant.	4.81	0.41
<b>Customer Satisfaction</b>	I would return to this restaurant in the future.	4.57	0.64
	I am satisfied with the restaurant's service quality.	4.57	0.65
	I am very satisfied with my overall experience at this restaurant.	4.53	0.70
	Overall, this restaurant puts me in a good mood.	4.56	0.64
	I will recommending the restaurant to others.	4.58	0.70

Food safety, item one score the highest mean value which was 4.69, where

the respondents strongly agree that clean utensils are important to customer

satisfaction. The lowest mean is item five, with the mean value of 4.3617, where the respondent somewhat strongly agree that customers would like to know the ingredient about the food they are consuming. Online review, item one score the highest mean value which was 4.61, where the respondents strongly agree that online review will strongly effect customer satisfaction and influence their decision to visit the restaurant. The lowest mean is item two, with the mean value of 4.52, where the respondent somewhat strongly agree that customers will absolutely do some research about the restaurant depend on the previous customer reviews. Staff attitude, item two and three has the same score highest mean value which was 4.61, where the respondents strongly agree that effective communication skills and ability to professional accommodate customers complain are one of the important aspects in restaurant. Meanwhile the lowest mean is item one, with the mean value of 4.57 and it indicates that customers also strongly agreed that to be able to handle customers special need are essential part of the restaurant. Cleanliness, item one score the highest mean value which was 4.85, where the respondents strongly agree that customer will give good rating if the restaurant is clean. The lowest mean is item 4, with the mean value of 4.81, where the respondent somewhat strongly agree that customers will be satisfied if a high budget restaurant has a high level of cleanliness. Customer satisfaction, item five score the highest mean value which was 4.58, where the respondents strongly agree that satisfied customers will recommend others to come to the restaurant. The lowest mean is item three, with the mean value of 4.53, where the respondent somewhat strongly agree that customers satisfied. The scale for the intention of the hotel workers in Kota Bharu to turnover is derived from the table above by adding the means and standard deviations for the five components. The measuring items' averages ranged from

3.53 to 4.58, and their standard deviations were between 0.637 and 0.699.

**Table 3: Reliability Analysis**

No of items	Study variable	Cronbach's alpha	Remarks (acceptable/not acceptable)
5	Food Safety	0.909	acceptable
5	Online Reviews	0.951	acceptable
3	Staff Attitudes	0.873	acceptable
4	Cleanlines s	0.871	acceptable
5	Customer Satisfaction Toward Restaurants	0.958	acceptable

The reliability analysis findings for the study variables were displayed in the table. The table shows that Food Safety is 0.909, Online Reviews is 0.951, Staff Attitudes is 0.873, Cleanliness is 0.871 and Customer Satisfaction Toward Restaurant is 0.958 which is Dependent Variable. In addition, all of the independent variable items which is Food Safety is 0.909, Online Reviews is 0.951, Staff Attitudes is 0.873 and Cleanliness is 0.871 were acceptable because the score result was over 0.70. Dependent variable, Customer Satisfaction Toward Restaurants, has a value of 0.958 indicating that the variables employed were appropriate and accurate in measuring this variable. In the nutshell, the reliability coefficients for the independent variables in this study according to Cronbach's Alpha were satisfactory and correlated with one another.

**Table 4: Pearson Correlation Analysis**

Hypothesis	Result	Finding of Data Analysis
<b>H1:</b> Food safety is positively related to customer satisfaction.	r = 0.791, p = 0.000 High positive	<b>H1: supported</b>
<b>H2:</b> Online review is positively related to customer satisfaction.	r = 0.616, p = 0.000 High positive	<b>H2: supported</b>
<b>H3:</b> Attitude of restaurant staff is positively related to customer satisfaction.	r = 0.651, p = 0.000 High positive	<b>H3: supported</b>
<b>H4:</b> Cleanliness is positively related to customer satisfaction.	r = 0.363, p = 0.000 High positive	<b>H4: supported</b>

Hypothesis 1 (H1) p-value was 0.001, which was less than a significant level of 0.01. The correlation coefficient of 0.791 suggested a high positive correlation between food safety and customer satisfaction.

Hypothesis 2 (H2) p-value was 0.001, which was less than a significant level of 0.01. The correlation coefficient of 0.616 suggested a moderate correlation between online reviews and customer satisfaction.

Hypothesis 3 (H3) p-value was 0.001, which was less than a significant level of 0.01. The correlation coefficient of 0.651 suggested a moderate correlation between staff attitude and customer satisfaction.

Hypothesis 4 (H4) p-value was 0.001, which was less than a significant level of 0.01. The correlation coefficient of 0.363 suggested a weak correlation between cleanliness and customer satisfaction.

## **DISCUSSION & RECOMMENDATION**

Cleanliness gives a low effect on customer satisfaction because through the result we can see the majority of the respondents are male. And most of the young people especially the male were not taking cleanliness as an important thing. Food safety got a higher result because most of the respondents are students. Most of the students have some knowledge about food safety and they are concerned because they are away from family. As a student, they cannot use ill as a reason to take the medical certificate. It is because they are busy to complete the assignment. After that, online reviews and staff attitudes give a positive impact on customer satisfaction. Most people will judge attitudes when they are dine-in.

Customer satisfaction can be better evaluated through data analysis, such as surveys, feedback forms, and customer reviews. Advances in data collection techniques, as well as emerging technologies such as natural language processing and sentiment analysis, will enable researchers to gain vital information directly from customers. Additionally, advanced analytics can go beyond simple metrics and into contextual analysis to better understand customer behavior related to restaurant recommendations. Data on customer preferences, location, time of day, and other pertinent aspects can be combined to gain a better understanding of how swift service affects customer satisfaction. Insights can be extracted from consumer reviews, social media posts, and online debates using natural language processing and sentiment analysis techniques. Cultural and regional differences may influence customer behavior, so researchers must account for these variances in future data collecting and analysis.

<https://doi.org/10.1080/09593969.2015.1068828>.

## CONCLUSION

Customer satisfaction has a substantial impact on overall contentment when choosing a restaurant, with food safety, online reviews, attitude, and cleanliness all playing a factor. According to the data, practically all respondents completed the survey questions on their satisfaction with restaurants in Kelantan. The majority of respondents firmly agreed that customer satisfaction has a significant impact on their satisfaction while selecting a restaurant. Respondents also agreed that food safety, online reviews, staff attitude, and cleanliness all played a role in their overall happiness.

## REFERENCES

- Akter, M., Sadekin, M. N., & Patwary, A. K. (2020). An Empirical Study on Students' Satisfaction from Mawlana Bhashani Science & Technology University, Bangladesh. *Review of Economics and Development Studies*, 6(2), 363-379.
- Alom, S., Patwary, A. K., & Khan, M. M. H. (2019). Factors affecting the turnover intention of Bangladeshi migrants in the United Arab Emirates: An empirical study on the hotel industry. *International Journal of Innovation, Creativity and Change*, 8(3), 344-360.
- Beneke, J., De Sousa, S., Mbuyu, M., & Wickham, B. (2016). The effect of negative online customer reviews on brand equity and purchase intention of consumer electronics in South Africa. *International Review of Retail Distribution & Consumer Research*, 26(2), 171-201.
- Chun, S. H., & Nyam-Ochir, A. (2020). The effects of fast food restaurant attributes on customer satisfaction, revisit intention, and recommendation using DINESERV scale. *Sustainability (Switzerland)*, 12(18), 1-19. <https://doi.org/10.3390/SU12187435>
- Fengmin, Z., Baijun, W., Jiangtao, B., Li, L., & Patwary, A. K. (2022). Investigating revisit intention of medical tourists in China through nutritional knowledge, perceived medical quality, and trust in the physiologist: A recommendation on health tourism policy measures. *Frontiers in Public Health*, 10, 893497.
- Food and Drug Administration (FDA) (2018). Adoption of the FDA Food Code by state and territorial agencies responsible for the oversight of restaurants and retail food stores-2016. Retrieved from <https://www.fda.gov/Food/GuidanceRegulation/FSMA/>.
- Food Safety Magazine Edigest (FSME) (2018). The future of food safety for the foodservice industry. Retrieved from <https://www.foodsafetymagazine.com/newsletter/the-future-of-food-safety-for-the-foodservice-industry>.
- Gupta, V., Kiatkawsin, K., Roy, H., Promsivapallop, P., & Duggal, S. (2022). How the consumers' intentions to pay a price premium are influenced in luxury fine dining restaurants? *Journal of Foodservice Business Research*, 1-30. <https://doi.org/10.1080/15378020.2022.2077089>

- Hazbar, A. M. H., Alem Mohammed, A., & Karim, A. K. A. (2019). An Empirical Study of Factors Influencing hotel customers' online booking Intention. *العلوم مجلة التربية والإنسانية الدراسات و التربوية*, (5), 1-17
- Hong, H., Xu, D., G.A., and Fan, W., 2017. Understanding the Determinants of Online Review Helpfulness: A Meta-Analytic Investigation. *Decision Support Systems* 102, 1-11. DOI: <http://dx.doi.org/10.1016/j.dss.2017.06.007>.
- Hussein, A. S. (2018). Revisiting the importance of casual dining experience quality: an empirical study. *International Journal of Quality and Service Sciences*, 10(3), 233–252. <https://doi.org/10.1108/IJQSS-04-2017-0041>
- Kesgin, M., & Murthy, R. S. (2019 ). Consumer engagement: The role of social currency in online reviews. *The Service Industries Journal*, 39(7-8), 609–636. <https://doi.org/10.1080/02642069.2018.15532>
- Lei, X., Qian, X., and Zhao, G., 2016. Rating Prediction Based on Social Sentiment from Textual Reviews. *IEEE Transactions on Multimedia* 18, 9, 1910-1921. DOI: <http://dx.doi.org/10.1109/TMM.2016.2575738>.
- Li, L., Ragavan, N. A., Patwary, A. K., & Baijun, W. (2022). Measuring patients' satisfaction toward health tourism in Malaysia through hospital environment, nutritional advice, and perceived value: A study on Chinese exchange students. *Frontiers in public health*, 10, 893439.
- Li, L., Wu, B., & Patwary, A. K. (2022). How marine tourism promote financial development in sustainable economy: new evidences from South Asia and implications to future tourism students. *Environmental Science and Pollution Research*, 29, 1155-1172.
- Li, L., Wu, B., & Patwary, A. K. (2022). The psychosocial factors affecting chinese Outbound Exchange and mobility students' academic performance during COVID-19. *Frontiers in psychology*, 13, 872516.
- Mekimah, S., & Sayad, N. (2020). The Impact of Food Safety Management System ISO 22000 on Customer Satisfaction and Loyalty, Case Study of Coca-Cola Company in Algeria. *Economics and Business*, 34(1), 246–260. <https://doi.org/10.2478/eb-2020-0016>
- Mmutle, T., & Shonhe, L. (2017). Customers' perception of service quality and its impact on reputation in the hospitality industry. *African Journal of Hospitality, Tourism and Leisure*, 6(3).
- Patwary, A. K., Roy, B., Hoque, R., & Khandakar, M. S. A. (2019). Process of developing a community based tourism and identifying its economic and social impacts: An Empirical study on Cox's Bazar, Bangladesh. *Pakistan Journal of Humanities and Social Sciences*, 7(1), 1-13.
- Paulose, D., & Shakeel, A. (2021). Perceived experience, perceived value and customer satisfaction as antecedents to loyalty among hotel guests. *Journal of Quality Assurance in Hospitality & Tourism*, 23(2), 447–481.

- Pizam, A., & Tasci, A. D. A. (2018). Experienscape: expanding the concept of servicescape with a multi-stakeholder and multi-disciplinary approach. *International Journal of Hospitality Management*, 76, 25-37. doi:10.1016/j.ijhm.2018.06.010
- Ribeiro, M. A., & Prayag, G. (2019). Perceived quality and service experience: mediating effects of positive and negative emotions. *Journal of Hospitality Marketing and Management*, 28(3), 285–305. <https://doi.org/10.1080/19368623.2018.1517071>
- Savelli, E., Murmura, F., Liberatore, L., Casolani, N. and Bravi, L (2017), “Food habits and attitudes towards food quality among young students”, *International Journal of Quality and Service Sciences*, Vol. 9 Nos 3/4, pp. 456-468.
- Schjøll, A., & Alfnes, F. (2017). Eliciting consumer preferences for credence attributes in afine-dining restaurant. *British Food Journal*, 119(3), 575–586. doi:10.1108/BFJ-06-2016-0264
- Sumethokula, P., Patwary, A. K., Srinuanpanc, B., Srinuanpand, C., Suwandee, P., Thammathikul, A., & Phanong, W. (2020). The potential of new tour repackaging for creative tourism among entrepreneurs in Nakhon Si Thammarat. *International Journal of Innovation, Creativity and Change*, 13(10), 1752-1771.
- Susskind, A. M., Kacmar, K. M., & Borchgrevink, C. P. (2018). The relationship of service providers’ perceptions of service climate to guest satisfaction, return intentions, and firm performance. *Cornell Hospitality Quarterly*, 59(4), 390–396. <https://doi.org/10.1177/1938965518777215>
- Thomas, M. J., Wirtz, B. W., & Weyerer, J. C. (2019). Determinants of online review credibility and its impact on consumers’ purchase intention. *Journal of Electronic Commerce Research*, 20(1), 1–20.
- Uslu, A., & Eren, R. (2020). Critical review of service quality scales with a focus on customer satisfaction and loyalty in restaurants. *Deturope*, 12(1), 64–84.
- Wu, B., Liu, S., Wang, J., Tahir, S., & Patwary, A. K. (2021). Assessing the mechanism of energy efficiency and energy poverty alleviation based on environmental regulation policy measures. *Environmental Science and Pollution Research*, 28, 40858-40870.
- Wu, B., Zhai, B., Mu, H., Peng, X., Wang, C., & Patwary, A. K. (2021). Evaluating an economic application of renewable generated hydrogen: A way forward for green economic performance and policy measures. *Environmental Science and Pollution Research*, 1-15.
- Yang, S.-B., Shin, S., Joun, Y., & Koo, C. (2017). Exploring the comparative importance of online hotelreviews’ heuristic attributes in review helpfulness: A conjoint analysis approach. *Journal of Travel & Tourism Marketing*, 34(7), 963–985. <https://doi.org/10.1080/10548408.2016.1251872>

# Study of Workplace Environment, Reward and Recognition on Job Satisfaction Among Employees' Malaysian Hotel Industry

\*Nur Ida Fatimah Bt Che Shalifullizam

Zuhaira Binti Zamri, Zaidatul Izzati Binti Mohd Zalani, Lee Suet Kei, Zulshahmee Bin Zulkiflee

Faculty of Hospitality, Tourism and Wellness, University Malaysia Kelantan

Corresponding email: [h20a1883@siswa.umk.edu.my](mailto:h20a1883@siswa.umk.edu.my)

---

## ABSTRACT

*The hotel industry is one of the most important components of the wider service industry, catering to customers who require overnight accommodation. It is closely associated with the travel and hospitality industries, although there are notable differences in scope. Succeeding the issue of labor shortages in the hospitality sector related to job satisfaction, we investigate two factors that may be contributed to this problem which are reward and recognition and workplace environment. So, this study was done to examine the influence of reward and recognition, and workplace environment on job satisfaction among hotel employees' Malaysian hotel industry. In particular, there are two objectives to identify which are the influence of reward and recognition on job satisfaction and to find the relationship between workplace environment on job satisfaction. To complete the study, we distributed the questionnaire containing three parts and 20 questions to four hundred respondents, the hotel employees. This study is quantitative and has been analyzed using descriptive analysis and using the SPSS software.*

***Keywords: hotel industry, reward and recognition, workplace environment, job satisfaction, descriptive analysis, and quality employees.***

---

## INTRODUCTION

The segment of the service sector that deals with guest accommodations is the hotel business. The term "hotel industry" is used to describe a variety of lodging options, including hotels as well as inns, motels, hostels, and guest homes. It typically excludes long-term or permanent accommodation though. One of the areas with the quickest growth in the twenty-first century is the hotel industry. In this field, hotel management is essential, and running a hotel is a demanding job. Such positions can only be filled by the most competent candidates, therefore if you are prepared for this exciting work opportunity, it will help you advance both personally and professionally. The world hotel sector has recently encountered a number of difficulties and problems. The issue includes a labor and talent deficit. That is what is currently taking place in Malaysia. The travel sector became the third highest contributor to the country's gross income following the country's economic recovery process. The Malaysia hospitality sector is currently faced with a critical problem in that the development of the hospitality industry is growing slowly despite the increasing demand at the moment. Persatuan Hotel Malaysia (MAH) Pahang chairman, Patrick Tee, said a shortage of about 15 percent of the workforce with a budget of about 15,000 people across the country, led to hotel management only being able to operate at 85 percent level only including in Pahang. He said hotel management needs manpower especially in the room packing and food preparation sections but failed. "Since the government



announced the country is now in the endemic transition, people have been moving here and there and the tourist center becomes a crowded focus especially during weekends or public holidays. "The unfortunate shortage of hospitality sector workers may have caused the services to be affected and this will give us a bad image. "Foreign tourists are also increasingly coming to our country, but the rooms provided cannot be fully opened following the shortage of workers," he said.

## **BACKGROUND OF STUDY**

The hotel industry in Malaysia is experiencing increasing profits and job satisfaction, making it one of the most popular tourist destinations in the world. However, the industry faces challenges such as high turnover rates, lack of motivation, and poor employee training. The Malaysian Employers Federation reports a 65.7% turnover rate, highlighting the need for improvements. The hotel industry faces labor shortages and unstable appraisals, leading to increased turnover rates. To maintain stability, employers must identify employees' strengths and place them in the right positions to improve themselves. By addressing these issues, the hotel industry can continue to grow and thrive in Southeast Asia.

## **PROBLEM STATEMENT**

This study looked into the relationship between job training and job happiness in industrial hotels. Today, one of the biggest employers in the nation is the hotel sector. This is due to the large number of tourists and travelers both domestically and internationally who attempt to escape the stress of work-related obligations by travelling. As a result, it's critical for industrial hotels to hire personnel who are capable in both personality and job.

The hotel sector has experienced recent job losses (Nazaraly, 2022). This is due to the likelihood that employees may become involved in a variety of issues brought on by a variety of causes. Among the potential factors in the workplace. The setting in which a person pursues a profession is their workplace. The term "working environment" can be used to describe both the location and the circumstances under which people carry out their duties and earn a living. The working environment has a direct impact on job satisfaction. Labrague and others, (2022) Relationships with the workers are fostered over the long term through a positive workplace culture. Job satisfaction is significantly impacted by the workplace.

The absence of employee rewards and recognition could be the second cause. Either internally or publicly, awards and recognition are offered to those who do successfully. There is a presence of recognition and reward in the workplace when employees' achievements are fairly and immediately recognized. This includes paying employees fairly and consistently, celebrating teams or employees, and acknowledging years of service or successes (Darwinbox, 2019). Human resource management should incorporate components of reward and recognition since

they can boost employees' productivity. Additionally, it develops a more reliable employer brand. Employees talk and swap tales with counterparts from different companies.

The purpose of this study is to experimentally evaluate the relationship between reward and recognition, work environment, and job satisfaction among hotel employees in Malaysia based on the aforementioned topics. The following immediate goals help to support the main goals:

1. To examine the influence of workplace environment on job satisfaction among hotel employees
2. To examine the influence of reward and recognition on job satisfaction among hotel employees in Malaysia

## **SIGNIFICANCE OF THE STUDY**

### **1. Academic Aspect**

From a theoretical standpoint, despite the growing interest in hotel industry employee satisfaction, there has been very little research on hotel employee satisfaction in Malaysia since the Covid-19 pandemic. It is also anticipated that the contribution this study makes to the Malaysian hotel sector will be used to determine how original the study is. In light of the theoretical underpinnings of this study, which are founded in past study, it is clear that this the result of past study is capable of guiding us to get the results. The novelty of this research work will contribute to a deeper understanding of the hotel business with the help of pertinent literature. This methodology is anticipated to make understanding employee happiness more straightforward.

### **2. Practical Aspect**

Practically speaking, market research is absolutely necessary to assist owners of companies that offer services to the food sector in creating effective and long-lasting marketing plans. Additionally, this study can draw in more patrons for the food industry. The results of this study may be helpful to both the business and food industries. In particular, they offer business owners customer suggestions, which are crucial for developing competitive food industry business strategies that will market the food industry. In other words, this study offers a chance to learn more about SME businesses in the food sector of the business world.

## **LITERATURE REVIEW**

### **Reward And Recognition**

Rewards and recognition are important for companies to motivate employees and keep them interested in their work. Companies use incentives and recognition to help employees motivate and perform better. There are many

types of recognition, such as regular recognition events, monthly or annual employee awards, and annual reports or yearbooks that highlight employee achievements. Rewards and recognition have been proven to strengthen teamwork, increase customer satisfaction, enhance company value, and encourage specific employee actions. Everyone in the company has the opportunity at any time to show recognition, a personal appreciation for a job well done.

### **Workplace Environment**

The key detail of this paper is that organizations should provide a healthy work environment to ensure that the environment is conducive to employees, thereby increasing their job satisfaction and quality of work. A positive work environment is one characterized by trust, collaboration, safety, support for risk-taking, accountability and equality. Research shows that workers' decision to stay in their current job is influenced by the work environment, and employers should provide psychosocial support and serve as role models in counseling. Leadership support can also reduce work-family friction, emotional exhaustion, and turnover intentions.

### **Job Satisfaction**

Job satisfaction is defined as a person's positive emotional response to a particular job that results from the person's positive comparison of actual results with those expected, expected, or deserved. Has been shown to have a positive relationship with employee retention, and it has been suggested that when employees stop working due to factors such as unsafe working conditions, uncooperative colleagues, or managers who make poor decisions They leave the fabric. To reduce these costs, organizations must provide a flexible work environment where employees feel that their ideas are valued and that they are part of the company. Additionally, previous research has shown that managerial communication has a significant impact on job satisfaction and that high levels of manager-employee communication are associated with happier employees.

### **HYPOTHESIS**

H1: Workplace environment is significantly related to the job satisfaction of hotelemployees in Malaysia.

H2: Reward and recognition are significantly related to the job satisfaction of hotel employees in Malaysia.

## CONCEPTUAL FRAMEWORK

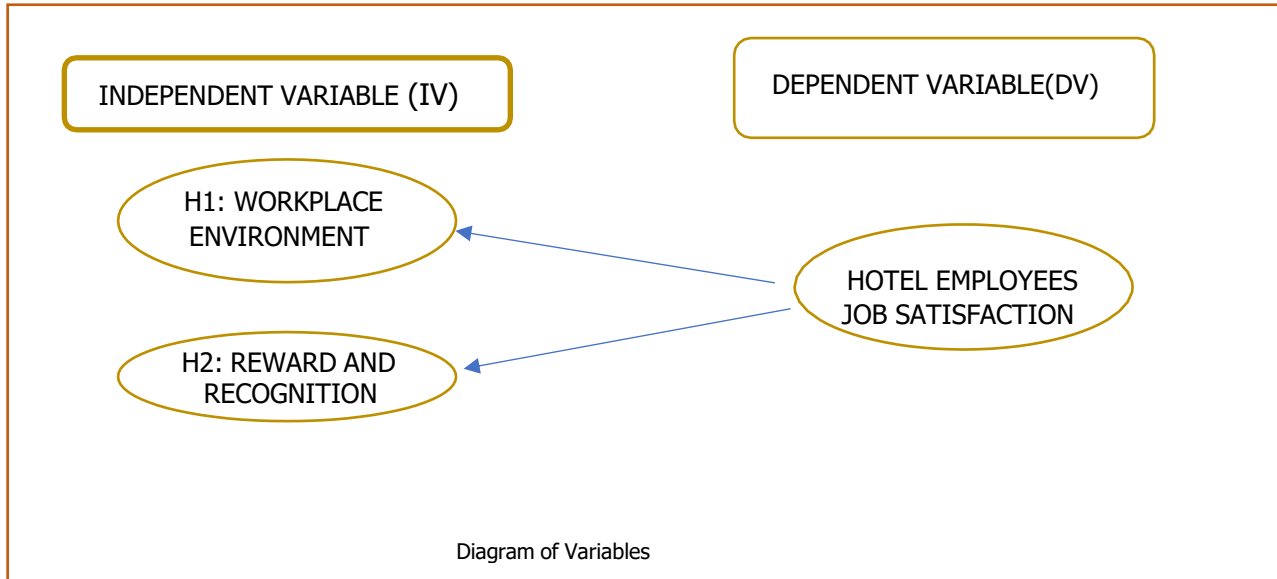

## METHODOLOGY

To get the raw data for this investigation, researchers will employ quantitative methods. The researchers can learn more about these aspects' effects on Malaysian hotel employees' job satisfaction in the workplace by employing this approach to their research. We will use primary data from the questionnaire we will hand out to Malaysian hotel staff members in this study. We will first employ a sample random sampling technique. We shall start by listing the hotels that are currently open in the state. The questionnaire will then be distributed at a few of the hotels that we will choose at random. Then, based on the modest number of hotels, we will gather 25 hotel employees to serve as our respondents and provide us with accurate data. Since we have a population of more than a million, Krejcie et al. (1970) determined that 384 respondents must complete the questionnaire as a minimum.

Systematic random sampling is the type of sampling technique we shall utilise in this study. We will obtain random data from the respondents by using a systematic random sample, which will increase the veracity and viability of the research findings. Data organization, modification, inspection, and transformation are all parts of data analysis. This would offer test findings as well as interviewee responses to the conducted survey instrument based on this analytical data. Statistical Package for Social Science, or SPSS, was used to analyse the survey's questions. The data will next be subjected to a descriptive analysis. This allows the data to be divided according to the research criteria. Following the data's classification, we will follow it with a Pearson Correlation analysis to make sure the

static data we collected is connected to the dependent variable. The Pearson Correlation coefficient is used to examine the relationships between the study's variables.

## FINDINGS

### Result of frequency analysis.

NO.	BACKGROUND CHARATERISTIC	FREQUENCY	PERCENTAGE (%)	
1	Gender	Male	164	41.0
		Female	236	59.0
2	Age	20 - 30 years old	130	32.5
		30 - 40 years old	184	46.0
		40 years old and above	86	21.5
3	Marital	Single	137	34.3
		Married	234	58.5
		Divorced	23	5.8
		Others	6	1.5
4	Education Level	SPM	110	27.5
		Diploma	148	37.0
		Degree	89	22.3
		Master	18	4.5
		Phd	7	1.8
		Other	28	7.0
5	Income	RM 1000 and above	240	60.0
		RM 2000 and above	123	30.8
		RM 3000 and above	37	9.3

Table of Analysis Respondent Background Information

Analysed by gender of the respondents, there were a total of 400 respondents in this survey. Of the 400 respondents, 59.0% female respondents are higher than male 49.0%. Respondents were divided into three age groups by age distribution. The largest number of respondents came from one of the younger age groups at 30 years old to 40 years old, with 184 people equal to 46.0%. Then, the marital distribution of the respondents is then shown, the largest marital distribution participating in this study is married status at 58.5% of 400 respondents. While divorce status marital got the low rank in the data at 5.8% equal to 23 people from total number of respondents. People came from diploma eligibility are equivalent to 37.0% equal to 148 respondents. SPM level are as many as 110 people equal to 27.5%. The Degree level has a total of 89 people equivalent to 22.3%. Master's level is as many as 18 people equal to 4.5%. The PhD level which is 7 people equivalent to 1.8% and other levels 28 people equivalent to 7.0%. Analysis of respondents based on monthly income showed that 240 respondents or 60.0% had a monthly income of RM 1000 and above. The monthly income is between RM 2000 and above is 123 people or 30.8%. Next, respondents with a monthly income of RM 3000 and above 37 respondents or 9.3%.

### Result of descriptive analysis.

Variable	Items	Mean score	Standard Deviation
Workplace environment (IV)	Hotel with clear vision, mission, organization structure, and policies.	3.84	0.961
	Have right tools or equipment for the job.	3.94	1.077
	Better occupational health and safety at work.	3.49	1.21
	Good location of workplace.	3.8	0.875
	Good coworkers and managers.	3.77	1.157
Reward and Recognition (IV)	Receive thanks and appreciation for job well done	2.87	1.397
	Freedom of creativity and judgement at work	3.26	1.068
	Receive service charge, bonuses, tips, and cash prize for job well done	3.7	1.189
	Good system of promotion	3.17	1.342
	Understanding of personal problems by management and help solving it	2.91	1.069
	Job matched with skills and knowledge	3.4	1.001
	Receive respect and value by the management	3.31	1.158
Offer trust and ownership at work	3.04	1.295	
Job Satisfaction among hotel employees (DV)	The hotel is able to listen to your problem with work	4.12	1.776
	The hotel briefing you completely about your task	4.94	1.773
	You have chances to talk about future opportunities in your hotel	4.17	1.662
	The hotel gives an additional benefit to their employee in healthcare.	4.74	1.82
	The hotel put you in a suitable place for you to do the work	4.9	1.592
	The decision issued by the hotel toward employees will refer to the employees' opinion first	4.89	1.723
	Overall, you are satisfied with the hotel where you work	4.95	1.963

Table of Result of descriptive analysis.

There were five (5) item questions that related to the work environment in the hotel industry. For the work environment, Cronbach’s Alpha was 0.886 which is very good. Based on the descriptive analysis that we have done; the highest average mean was WE2 as much as 3.94 and 1.077 for the standard deviation. Next, the second highest mean recorded was WE1 as much as 3.84 and for the standard deviation was 0.961. Followed by WE4 that recorded the mean as much as 3.80 and 0.875 for the standard deviation. Thus, is WE5 that the mean was as much as 3.77 and 1.157 for the standard deviation. Lastly, the lowest mean for the first independent variable in our research was WE3 which the mean recorded was as much as 3.49 and 1.210 for the standard deviation. Analysis of Reward Recognition the highest mean among eight types of items is the RR3 at 3.70. RR3 talks about the receive service charge, bonuses, tips, and cash prize for the good work. Next, the second highest mean for item in reward recognition analysis is the RR6 at 3.40 and the third highest followed by RR7 at 3.31. These two items are pinned about the job matched with skills learning and for the item RR7 is feel valued by management. Then, the item for RR2 is bigger than RR4 that stated the mean at 3.26 compared to 3.17. This proves that the employee feels the hotel management gives them more freedom at the workplace than improve the good system in promotion. After that, the item RR8 is rated at the sixth places with the 3.04 mean and its talk about the offering the trust and ownership at work. Moreover, the items RR1 is placed at the last and it follows the item RR5. Both of these items stated the mean at 2.87 and 2.91. There were seven (7) item questions that related to hotel employees job satisfaction in hotel industry. For the hotel employees’ job satisfaction, Cronbach’s Alpha was 0.917, which is very good. Based on the descriptive analysis that we have done; the highest average mean was HEJS7 as much as 4.95 and 1.963 for the standard deviation. Next is, the second highest mean recorded was HEJS2 as much as 4.94 and for the standard deviation was 1.773. Moreover, HEJS5 recorded the third highest mean as much as 4.90 and 1.592 for the standard deviation followed by HEJS6 that recorded the mean as much as 4.89 and 1.723 standard deviation. Furthermore is, HEJS4 which that the mean as much as 4.74 and 1.820 for the standard deviation. The lowest mean for dependent variable in our research was HEJS3 as much as 4.17 and 1.662 for the standard deviation. The second lowest mean recorded was HEJS1 as much as 4.21 and 1.776 for standard deviation.

**Pearson Correlation Analysis**

<b>Variables</b>	<b>Number of Items</b>	<b>Cronbach’s Alpha Coefficient</b>	<b>Strength of Association</b>
------------------	------------------------	-------------------------------------	--------------------------------

Independent Variables (IV) Workplace Environment	5	0.886	Very good
Independent Variables (IV) Reward and Recognition	8	0.919	Excellent
Dependent Variables (DV) Hotel Employees Job Satisfaction	7	0.917	Excellent

Table for Result of reliability Cronbach's Alpha Coefficient for the Independent Variables (IV) and Dependent Variables (DV)

According to the results of the reliability test, these variables were the strongest for Cronbach Alpha coefficients which is the first variable (Hotel Employees Job Satisfaction) got 0.917 for result. The highest variable is the Reward and Recognition which started at 0.919 while the third variable which is the workplace environment is listed at 0.886 and was lower than these two variables. It also shows that the dependent variable the excellent for the strength of association. In conclusion, having the Cronbach Alpha analysis able to prove the acceptable of our survey towards the respondent which is the hotel employees. The quantitative descriptive method approach has described how workplace environment and reward and recognition can improve job satisfaction among hotel workers in Malaysia. The descriptive analysis in this part includes dependent variables (hotel employees' job satisfaction) as well as independent variables (workplace environment, reward, and recognition). SPSS software was used to analyze the data that were gathered via an online survey that was circulated. A 5-point Likert scale is used to evaluate Section B of the questionnaire: 1 = strongly disagree, 2 = disagree, 3 = slightly agree, 4 = agree, and 5 = strongly agree. Additionally, the questionnaire's Section C is evaluated using a 7-point Likert scale, where 1 = strongly disagree, 2 = disagree, 3 = slightly disagree, 4 = NATURAL 5 = slightly agree, 6 = agree and 7 = strongly agree. The findings of the analysis are depicted in the table below.

## DISCUSSION AND RECOMMENDATION

Appreciation towards hotel employees is a crucial thing that needs to be concerned among hotel management or employer. The findings of this study also prove that the hotel employees got less appreciation from their employers. It can be seen in section two findings at the reward and recognition variable rated the appreciation by employers to hotel employees is very low. Hotel management needs to respect their employees too by encouraging the managers to have a good understanding of their staff. Makes them feel that there are valuable to the hotel. Giving the gift to the hotel employees manages to make them loyal to the hotel too. Showing the hotel employees, positive vibes at the workplace like always saying thank you and well done after they're done their jobs also help increase their job satisfaction. In the end, showing appreciation towards the hotel employees help them in increasing job satisfaction.

Managing the hotel employees is also hard work to be done by a manager. Moreover, when it comes to choosing them to increase their positions among hotel employees. Hotel management must identify the few candidates among



hotel employees that are worth that position. To make it become fairer the hotel management needs to appoint two or three managers to become the judges. By doing this, employees will be satisfied with the choices that are made by them. Hotel management can create a list of criteria for the person that increases the positions in the workplace. The judges must be strict in picking the employee who is suitable to take the positions. Having fair competition will make the hotel employees accept the final decisions that are made by their managers.

Every human needs to be good to another for reaching peaceful conditions. The person who works at the hotel needs to interact with the humans. As we know, humans have many criteria and various behaviors. Facing different people with different behaviors will make the hotel employee become more stressed in doing their jobs. Plus, the complaints and harsh words that they face will reduce their job satisfaction. People around them should use appropriate words and suitable communication to talk with the hotel employees. It will make them happy and enjoy keeping doing their work. Get a smile from the guest and thank you will make their days as the hotel employees. Guests also can show some respect to the hotel employees by talking politely when dealing with them. Increasing the appreciation to the hotel employees manages to increase their job satisfaction in the workplace. It also creates a profit to the hotel as the employer because they do not spend their resources to train new employees every time.

### **Conclusion**

Based on the results of the study, this research has been carried out to analyze whether reward and recognition and workplace environment are affecting job satisfaction among hotel employees in Malaysia. Moreover, this study explains more about job satisfaction among hotel employees from their perspective. The result that has been gained in Chapter Four using the Statical Package for Social Science (SPSS) has been analyzed and further discussed in Chapter Five. As a result, we can conclude that is a significant relationship between job satisfaction among hotel employees with reward and recognition and the workplace environment. Therefore, it is hoped that all the information provided by this research will help the hotel management to solve the turnover rates among hotel employees and at the same time manage the hotel employees to work in a comfortable and appropriate workplace.

## REFERENCES

- Abdulaali, H. S., Usman, I. M. S., & Al-Ruwaishedi, M. R. (2019). A Review on Sustainable and Green Development in the Tourism and Hotel Industry in Malaysia. *Journal of Advanced Research in Dynamical and Control Systems*, 11(10-SPECIAL ISSUE), 854–867. <https://doi.org/10.5373/jardcs/v11sp10/20192881>
- Akter, M., Sadekin, M. N., & Patwary, A. K. (2020). An Empirical Study on Students' Satisfaction from Mawlana Bhashani Science & Technology University, Bangladesh. *Review of Economics and Development Studies*, 6(2), 363-379.
- Al Mahmud, S. R. (2020). The effectiveness of Facebook advertisements on purchase intention of customers in Malaysia. *South Asian Journal of Social Sciences and Humanities*, 1(1), 97-104.
- Alom, S., Patwary, A. K., & Khan, M. M. H. (2019). Factors affecting the turnover intention of Bangladeshi migrants in the United Arab Emirates: An empirical study on the hotel industry. *International Journal of Innovation, Creativity and Change*, 8(3), 344-360.
- Alvarez, B.L. (2015, March 24). HOSPITALITY EMPLOYEE RIGHTS AND RESPONSIBILITIES WORKBOOK. Beatriz Lopez Alvarez Academia.edu. <https://www.academia.edu/11640916/>
- Amin, Z., & Akbar, K. P. (2013). Analysis of Psychological Well-being and Turnover intentions of Hotel Employees: An Empirical Study. *International Journal of Innovation and Applied Studies*, 3, 2028-9324.
- Arthur, W., Bennett, W., Edens, P. S., & Bell, S. T. (2013). Effectiveness of training in organizations: A meta-analysis of design and evaluation features. *Psychology*, 88(2), (234–245).
- Artinah Zainal & Iskandar Adullah. (2003). Management Training Approaches in the Malaysian Hotel Industry. *Team journal of hospitality tourism part7 Vol. 1(1): 52-53*
- Barzegar, N., & Farjad, S. (2011). A Study on the Impact of Job Training Courses on the Staff Performance. *Procedia - Social and Behavioral Sciences*, 29, 1942– 1949. <https://doi.org/10.1016/j.sbspro.2011.11.444>
- Beh, L. S., & Shah, S. H. A. (2017). Skills Enhancing Practices on Turnover Intentions: Bhandari, P. (2022b, December) Independent vs. Dependent Variables | Definition & Examples. Scribbr. <https://www.scribbr.com/methodology/independent-and-dependent-variables/>
- Bellary, G., Venugopal, P., & P, G. (2014). Executive's Perception on the Outcomes of In- House and Outdoor Training Programs. *Science*, 10(8).
- Brief, A. P., & Weiss, H. M. (2002). Affect in the workplace. *Annual review of psychology*, 53(1), 279-307

- Bukhari, Syed Abdul. (2021). Sample Size Determination Using Krejcie and Morgan Table. 10.13140/RG.2.2.11445.19687.
- Chiradeep BasuMallick. (2020).
- Cwibi, Mzukisi. (2023). What do hotel managers think of employee rewards? An exploration of five-star hotels in CapeTown. International Conference on Tourism Research. 6. 462-469. 10.34190/ictr.6.1.1292.
- Darwinbox. (2023). What is rewards & recognition (R&R)? | Meaning & definition | HR glossary. Darwinbox - HR Software | New-Age HR Management Software. <https://explore.darwinbox.com/hr-glossary/rewards-and-recognition>
- Diamantidis, A. D., & Chatzoglou, P. D. (2012). Evaluation of formal training programmes in Greek organisations.910.
- Din, K. H. (2018). Dialogue with the hosts: An educational strategy towards sustainable tourism. In Tourism inSouth-East Asia (pp. 345-354). Routledge.
- Farah Laili, Nor Ailis, Anita Ismail & Latifah. (2019). JOB SATISFACTION AND WORK LIFE QUALITY AMONG EMPLOYEES OF HOTEL INDUSTRY IN MALAYSIA. Analysis of the Development Pattern of Merauke City Vol.10(04): 2286-2287
- Fengmin, Z., Baijun, W., Jiangtao, B., Li, L., & Patwary, A. K. (2022). Investigating revisit intention of medical tourists in China through nutritional knowledge, perceived medical quality, and trust in the physiologist: A recommendation on health tourism policy measures. *Frontiers in Public Health*, 10, 893497.
- Friedman, J., (2022, November 7). 12 benefits of training employees in today's workplace. Emeritus Online Courses.<https://emeritus.org/blog/benefits-of-training-employees/>
- Gazija, A. (2022, December 14). Importance of staff training in hotel industry Case Study: Hotel Dukagjini. ResearchGate | Find and share research. [https://www.researchgate.net/publication/306524132\\_Importance\\_of\\_staff\\_training\\_in\\_hotel\\_industry](https://www.researchgate.net/publication/306524132_Importance_of_staff_training_in_hotel_industry)
- Glassdoor Team. (2021). The Work Environment: Definition, Key Features, and Types. <https://www.glassdoor.com/blog/guide/work-environment/>
- Hafee, I., Yingjun, Z., Hafeez, S., Mansoor, R., & Rehman, K. U. (2019). IMPACT OF WORKPLACE ENVIRONMENT ON EMPLOYEE PERFORMANCE: MEDIATING ROLE OF EMPLOYEE HEALTH. *Business, Management and Education*, 17(2), 173–193. <https://doi.org/10.3846/bme.2019.10379>
- Haldorai, K., Kim, W. G., Pillai, S. G., Park, T. E., & Balasubramanian, K. (2019). Factors affecting hotel employees' attrition and turnover: Application of pull-push-mooring framework. *International Journal of Hospitality Management*, 83, 46-55. <https://doi.org/10.1016/j.ijhm.2019.04.003>
- Haslina Halim, Tengku Md, Farah Lina & Nazrul Shazleen. (2021) Workplace Environment, Leader Communication and Hotel Employee. *Jurnal Komunikasi: Malaysian Journal of Communication* Jilid 37(4): 386-389
- Hassan, A., Gobal, S.T.V., Baker, R., Mohd Yunus, W.M.A.W., & Norazman, I. (2018). ResearchGate Find and share research. [https://www.researchgate.net/publication/324886579\\_The\\_Effect\\_of\\_Training\\_on\\_Job\\_Satisfaction\\_A\\_Review\\_Paper](https://www.researchgate.net/publication/324886579_The_Effect_of_Training_on_Job_Satisfaction_A_Review_Paper)

- Hazbar, A. M. H., Alem Mohammed, A., & Karim, A. K. A. (2019). An Empirical Study of Factors Influencing hotel customers' online booking Intention. *مجلة العلوم التربوية و الدراسات الإنسانية*, (5), 1-17.
- Ikart, E. M. (2019). Survey Questionnaire Survey Pretesting Method: An Evaluation of Survey Questionnaire via Expert Reviews Technique. *Asian Journal of Social Science Studies*, 4(2), 1. <https://doi.org/10.20849/ajsss.v4i2.565>
- Jeetesh K, S. G. (2015). The Effects of Job Satisfaction on Employee Turnover in the Hotel Industry: A Case Study of Hotels in Kuala Lumpur City Centre. *& Hospitality*, 04(01).
- Jennifer Herry. (2019). Types of Work Environments (And How to Find the One for You). <https://www.indeed.com/career-advice/finding-a-job/types-of-work-environments>
- Judge, T. A., Weiss, H. M., Kammeyer-Mueller, J. D., & Hulin, C. L. (2017). Job attitudes, job satisfaction, and job affect: A century of continuity and of change. *Psychology*, 102(3), 356–374. Knowledgecity. (2022).
- Krejcie, R. V., & Morgan, D. W. (1970). Determining Sample Size for Research Mediating Role of Affective Commitment in Hotel Industry, Malaysia. *Advanced Science Letters*, 23(9), 9208-9214. <https://doi.org/10.1166/asl.2017.1005>

- Li, L., Ragavan, N. A., Patwary, A. K., & Baijun, W. (2022). Measuring patients' satisfaction toward health tourism in Malaysia through hospital environment, nutritional advice, and perceived value: A study on Chinese exchange students. *Frontiers in public health*, 10, 893439.
- Li, L., Wu, B., & Patwary, A. K. (2022). How marine tourism promote financial development in sustainable economy: new evidences from South Asia and implications to future tourism students. *Environmental Science and Pollution Research*, 29, 1155-1172.
- Li, L., Wu, B., & Patwary, A. K. (2022). The psychosocial factors affecting chinese Outbound Exchange and mobility students' academic performance during COVID-19. *Frontiers in psychology*, 13, 872516.
- Muhammad, L. R. I. (2022, March 14). THE IMPACT OF WORKING ENVIRONMENT ON EMPLOYEES JOB SATISFACTION: A CASE STUDY OF PRIVATE SCHOOLS IN PESHAWAR CITY. *Psychology and Education Journal* <http://psychologyandeducation.net/pae/index.php/pae/article/view/7260>
- Muhammad, L., Amin, M., Khattak, A. Z., Mehsud, A. K., & Mustafa, R. (2022). Impact of Leadership Styles on Employee Wellbeing and Resilience during COVID-19: A Partial
- Mumtaz, R., & Hasan, S. S. (2018). Determinants of Employee Turnover A Survey of Employee Intentions Trend in Urban Societies of the Region. *Journal*, 09(02).
- NAZARALY, M. Z. (2022, February 15). Kekurangan pekerja turut jejkaskan industri perhotelan. *Sinar Harian* <https://www.sinarharian.com.my/article/187882/berita/nasional/kekurangan-pekerja-turut-jejaskan-industri-perhotelan>
- Orfila-Sintes, F., Crespi-Cladera, R., & Martínez-Ros, E. (2005). Innovation activity in the hotel industry: Evidence from Balearic Islands. *Tourism Management*, 26(6), 851–865. <https://doi.org/10.1016/j.tourman.2004.05.005>
- Ottenbacher, M., & Gnoth, J. (2005). How to Develop Successful Hospitality Innovation. 222, 46(2), 205.
- Patwary, A. K., Roy, B., Hoque, R., & Khandakar, M. S. A. (2019). Process of developing a community based tourism and identifying its economic and social impacts: An Empirical study on Cox's Bazar, Bangladesh. *Pakistan Journal of Humanities and Social Sciences*, 7(1), 1-13.
- Pritha Bhandari. (2020). What Is Quantitative Research? | Definition, Uses & Methods. <https://www.scribbr.com/methodology/quantitative-research/>
- R Ibrahim, R. Z. A., Ohtsuka, K., Dagang, M. M., & Abu Bakar, A. (2014). Job Satisfaction Among Malaysian Employees: An Application of Spector's Job Satisfaction Survey in the Southeast Asian Context. *Jurnal Pengurusan*, 41, 69–79.
- Rafael San. (2021). What is the workplace environment and why is it important? <https://ifeelonline.com/en/occupational-health/workplace-environment/>
- Raziq, A., & Maulabakhsh, R. (2015). Impact of Working Environment on Job Satisfaction. 725.
- Revfine. (2022). Hotel Industry: Everything You Need to Know <https://www.revfine.com/hotel-industry/>
- Statista Research Department. (2022). Hotel industry worldwide - statistics & facts. <https://www.statista.com/topics/1102/hotels/#topicOverview>

- Sumethokula, P., Patwary, A. K., Srinuanpanc, B., Srinuanpand, C., Suwandee, P., Thammathikul, A., & Phanong, W. (2020). The potential of new tour repackaging for creative tourism among entrepreneurs in Nakhon Si Thammarat. *International Journal of Innovation, Creativity and Change*, 13(10), 1752-1771.
- Swaen, B. & George, T. (2022, November 15). What Is a Conceptual Framework? | Tips & Examples. Scribbr. Retrieved December 19, 2022, <https://www.scribbr.com/methodology/conceptual-framework>
- Taheri, R.H., Miah, S.Md., & Kamaruzzaman, Md. (2020). Impact of working environment on job satisfaction. *European Journal of Business and Management Research*. <https://www.ejbmr.org/index.php/ejbmr/article/view/643>
- Thpanorama. (2023) Apakah Reka Bentuk Penyelidikan dan Bagaimana Ia Dilakukan? <https://ms.thpanorama.com/articles/ciencia/qu-es-el-diseo-de-investigacin-y-cmo-se-hace.html>
- Umam, K. (2021, December 31). Tempat menarik Di Kuching Yang Terkini 2023 paling Menawan. Situs Info TempatWisata Terbaru & Paket Tour Terpercaya.
- Vera A, Peter A,B. (2015). Impact of Reward and Recognition on Job Satisfaction and Motivation. Academic Hosting & Event Management Solutions. <https://www.iiste.org/Journals/index.php/EJBM/article/download/25095/25961>
- Wanous, J. P., & Lawler, E. E. (1972). Measurement and meaning of jobsatisfaction. 95–105.
- WebstaurantStore. (2022). WHAT IS THE Hospitality Industry. <https://www.webstaurantstore.com/blog/3726/what-is-the-hospitality-industry.html>
- What is Employee Training and Why Is It Important to Corporations? <https://www.knowledgecity.com/blog/employee-training/>
- What Is Employee Training? Definition, Program Types, Best Practices, and Examples. <https://www.spiceworks.com/hr/learning-development/articles/what-is-employee-training/>
- Wu, B., Liu, S., Wang, J., Tahir, S., & Patwary, A. K. (2021). Assessing the mechanism of energy efficiency and energy poverty alleviation based on environmental regulation policy measures. *Environmental Science and Pollution Research*, 28, 40858-40870.
- Wu, B., Zhai, B., Mu, H., Peng, X., Wang, C., & Patwary, A. K. (2021). Evaluating an economic application of renewable generated hydrogen: A way forward for green economic performance and policy measures. *Environmental Science and Pollution Research*, 1-15.
- Zainol, N., Ahmad, R. A., Nordin, N., Tazijan, F., Ab Rashid, P. (2015). Employees Dissatisfaction and Turnover Crises: A Study of Hotel Industry, Malaysia (March 11, 2015). <http://dx.doi.org/10.2139/ssrn.2576603>

# THE FACTORS THAT HAVE INFLUENCED FINAL YEAR STUDENTS' UNIVERSITY MALAYSIA KELANTAN IN PURSUING A CAREER IN THE HOSPITALITY INDUSTRY

**Roszulaika Binti Rosli, Ainaa Syafiqah Binti Abdul Manan, Noor Anissa Farhana Binti Kamal, Muhammad Amirul Faiz Bin Adnnan, & \*Mohammed Ruqaimi Bin Remeli**

*Faculty of Hospitality, Tourism and Wellness, University Malaysia Kelantan  
Corresponding email: [ruqaimi@umk.edu.my](mailto:ruqaimi@umk.edu.my)*

## ABSTRACT

Most students who wanted to studied hospitality and hotel management in Malaysia did not knew how this subject was taught in universities. In summary, hotel management combines business, tourism, and culinary skills. University Malaysia Kelantan was one of the universities that presents hospitality costed to students in Malaysia. This studied was conducted to found out and studied the influencing factors in persuading to continue a career in the hospitality industry. A total of 118 university Malaysia Kelantan students in the hospitality sector, especially final year students, was sampled to answered random questionnaires to complete this studied. This question focuses on factors that had influenced in pursuing a career in the hospitality industry. Furthermore, the questions also focus on several factors which were related to social status, salary/benefit, and nature of worked. This studied was conducted because many students had taken the costed of hospitality, but they felt doubtful about the journey of this costed. There were also post-graduate students who felt that after graduation, there were no bright job opportunities for their careers. Furthermore, the main data for the studied collected by used a structured questionnaire, and the analysis was made by used SPSS software. The surveyed was distributed to 123 respondents of final year students in university Malaysia Kelantan. In this studied, descriptive, reliability tests, and correlation analysis was utilized to process the data. So, this studied enables researchers to knew more the factors that had influenced final year students in the university Malaysia Kelantan regarding careers in the hospitality industry.

**Keywords: Hospitality Industry, University Students, Social Status, Salary/Benefits, Nature of Work.**

## INTRODUCTION

Readers should be given the background knowledge necessary to comprehend the studied's goals and the rationale for this experiment when introducing. The primary goal of this study was to identify "the factors that have influenced final year students' university Malaysia Kelantan in choosing to pursue a career in the hospitality industry." This was done because generation Y students' perceptions of seniors at all universities had changed and been slightly modified from those of the generation that came before them. According to morton (2002), generation y workers had a propensity to valued equality in the workplace and looked for jobs with competitive pay and decent training chances. According to morton (2002), they valued managers who gave their staff the freedom to made decisions and who was straightforward with them.

The scope of the hospitality sector was considerable. It includes worked at establishments including hotels, eateries, casinos, theme parks, cruise lines, and other leisure and recreation-related services. Dealing with customers face-to-face in a variety of ways was a major component of many employments in the hospitality sector. However, there was some tasks

that was done in secret, such as those in accountancy, marketing, and sales. Additionally, there was many employments in the hospitality sector related to food services, such as waiter and cooked positions. Every university's final-year students, who would shortly entered the workforce, needed to underline how tightly related these topics was. For individuals had been more motivated to pursue a profession in the hospitality business, they also needed to had optimistic attitudes or viewpoints. There was therefore many factors that encouraged students to choose employment in the hotel industry.

Solved problems in determining a career in the hospitality industry was very important and allows graduates to decide whether they wanted to be continued in this field or not, in other words, students who did internships should did the job as well as possible carefully and asked more questions about the career field in hospitality (wang, 2021). Undoubtedly there was several aspects, including income, advancement prospects, and relations between managers that must been addressed by the sector to guaranteed that students had a favourable experience while working for their degree. Industry would continue to lost these qualified and trained workers if it could not provided better job opportunities and greater compensation for its graduates (s. Richardson, 2009). To avoided missing out on knowledge about a promising career for the future, all students who wanted to major in hospitality should commit to pursue a career in this sector, in addition to the students at the university Malaysia Kelantan. A good perception would gave good factors and would gave progress to the hospitality students themselves. This studied aims to improve the current understanding of the factors that have influenced final year students' university Malaysia Kelantan in pursuing a career in the hospitality sector and beyond because they was seen as future workers and managers of the industry.

### **Significant of The Study**

Based on this studied, the perception of graduates in this field of choosing a career in hospitality had been a topic of discussion among hospitality students. After high school, many students decided to enrol in colleges, but they must first decide what they wanted to be studied. In conclusion, there had not been much researched on why students chose to enrol in tourism or hospitality courses, yet some still did. Another crucial choice that students in this course must made was whether they wished to be worked in the hotel business after graduation. In this researched, the hospitality education was playing an important role in supporting the industry's human resource demands and development in Malaysia. It oversaw ensuring a steady flow of graduates with the necessary qualifications to meet the industry's expanding demand. Enrolments in the hospitality programme were anticipated to rise due to the increased need for professional and qualified professionals in all sectors of the hospitality industry. The importance of this studied was as a form of appreciation and support that the responsible parties listened to the problems of university students. This was because they had carried out their responsibilities as students by following the decisions or planned of the university or faculty and many more. In addition, the writing of this studied was also to give a suitable assessment to the students because they had tried to pursue their dreams and ambitions, but they had not yet determined what job to pursue in more detail because many hospitality industries currently wanted employees who had worked experience in this industry.

The existence of this research platform may have in part assisted in identifying students' dedication to pursue a career in the hospitality sectors while also suggesting solutions to the issue, as was covered below. This was intended to improve the current grasp of the factors that have influenced final year students' university Malaysia Kelantan in pursuing a career in the hospitality industry and beyond since they were seen as future industry workers and managers. In addition, this studied could also been used as a reference material for future researchers. For



future researchers, this studied was likely have been a second tool with other methodological methods in signalling determination to pursue a profession in the hospitality sector among hospitality students at university Malaysia Kelantan. The results of this study may also be used to inform instruction and learning at all societal levels, notably for university students considering a future in the hospitality sector.

## **LITERITURE REVIEW**

### **Nature of Work**

One of the variables that contributes to students' unfavourable opinions of the sector is work pressure. In other words, when students assume that careers in the hospitality industry are stressful and demanding (Grobelna & Dollot, 2018; Kulsuvan, 2000). Today's students choose a relaxed and enjoyable work environment rather than one that is pressure-filled and unpleasant. (Le, Mcdonald & Klieve, 2018; Ashton, 2017; Richardson, 2009). While working as casual employees in a particular industry, they look for a good manager or leader to help them make the task simple and understandable. However, because a leader's qualities aren't present, they are automatically put in a stressful situation where they must work under pressure. Instead of working under pressure and being tough, a positive work atmosphere made undergraduates attached to their perception. (Ashton, 2017; Richardson, 2008). Nachmias and Walmsley's (2015) research indicated that the type of the employment and the working conditions are the main factors in why students haven't entered the workforce. Ahmad, Rashid, and Shariff (2014) said that the majority of students do not want to work in the hospitality business since the job is demanding and tiresome owing to lengthy working hours, such as those necessary while working shifts.

### **Salary/Benefit**

The "total reward system" that characterises the compensation structure in the hotel sector is made up of several pay and non-pay components of remuneration. According to Boella and Goss-Turner (2013), a worker's basic wage pay earned while employed in the hotel business is not always reflective of his overall remuneration under this system. Free lodging is quite important to a hotel employee. According to Joo-Ee (2015), in some cases, minimum wage workers are better off with free housing than they are with pay as a benefit in kind. The minimum wage in the hospitality sector puts increasing pressure on overall salary levels. Up to 70% of hotel employees may be impacted by the Minimum Wages Order. Therefore, the salary gap between the rank and file and top-level workers will noticeably shrink if salaries are raised in compliance with the Minimum Wages Order. According to Suhaili (2012), many hotel operators are concerned that the widening salary disparity may demotivate senior-level personnel. Employers formerly provided compensation increases to represent the difference between the former and the latter in terms of abilities, experience, and responsibilities at work in order to sustain the wage disparity between these two types of employees (Joo-Ee, 2015).

### **Social Status**

The term "social status" discusses a person's standing or significance in relation to other members of a society. The degree of prominence, privilege, and honour that someone is thought to possess in society is referred to as their "social status." Because of the odd hours worked, they felt that this industry was unsuitable for them to enter because they would be required to work past their regular hours, including on weekends and into the evening (Farmaki, 2018; Richardson, 2008). Additionally, the majority of students have had They gain a deeper

understanding of the corporate world through work experience, such as industrial training. Although pupils have finished their hands-on instruction and turned it into Their perceptions of the hotel industry are more negative as a result of their lack of the unreliable, long hours. (Brown, Thomas & Bosselman, 2015; Roney & Öztin, 2007).

### **Factors That Have Influenced in Pursuing A Career in The Hospitality Industry**

Every industry has its own set of variables, and the hospitality sector is also affected by outside variables that have a direct impact on organisational behaviour and decision-making. For students, choosing a career can be a difficult decision because it affects the kind of employment they plan to follow in the future. Students struggle to match their profession choices with their skills and academic performance when they try to decide on a vocation.

According to (Kerka, S. 2000), The choice of a job is influenced by a wide range of factors, including personality, interests, self-concept, culture, globalisation, socialisation, role models, social support, and the accessibility of resources like information and money. (Bandura, A. Barbaranelli, C., Caprara, G., & Pastorelli, C. 2001). Mention that each person involved in the process is influenced by a variety of variables, such as their environment, personal traits, social connections, and level of education. The decision of a career is also impacted by internal or external forces. Many people are influenced by their parents' professional choices, whereas other people pick the careers that their educational choices have made possible for them to pursue. Some people choose to pursue their hobbies despite the possibility of financial gain. However, some people select prosperous professions. Students' opinions of their fitness for particular jobs have been found to be influenced by a variety of different factors, including their ethnic background, year in school, level of achievement, choice of science subjects, attitudes, and differences in work skills. (McQuaid and Bond, 2003). (Perrone, Zanardelli, Worthington, & Chartrand, 2001).

### **Research Hypotheses**

The study's hypothesis is to determine whether dependent variables and independent variables have any correlations or links. This study's findings, such as social status, salary and benefits, and the nature of work, have inspired University Malaysia Kelantan final-year students to pursue a career in the hospitality sector. The research's hypothesis is:

**H1:** There was significant relationship between social status and factors that had influenced in pursuing a career in hospitality industry.

**H2:** There was significant relationship between salary/benefit and factors that had influenced in pursuing a career in hospitality industry

**H3:** There was significant relationship between nature of work and factors that had influenced in pursuing a career in hospitality industry.

### **Research Framework**

With reference to the literature review, a studied framework had been sequentially developed to examine the relationship between the factors that had influenced in pursuing a career in the hospitality industry. The dependent variable consists of variables that had an impact on choosing to pursue a career in the hospitality industry. The independent variable the proposed consists of three was social status, salary/benefit, and nature of work. Therefore, below was a conceptual framework.

Figure 2.4: Conceptual Framework (El-Dief & El-Dief, 2019)

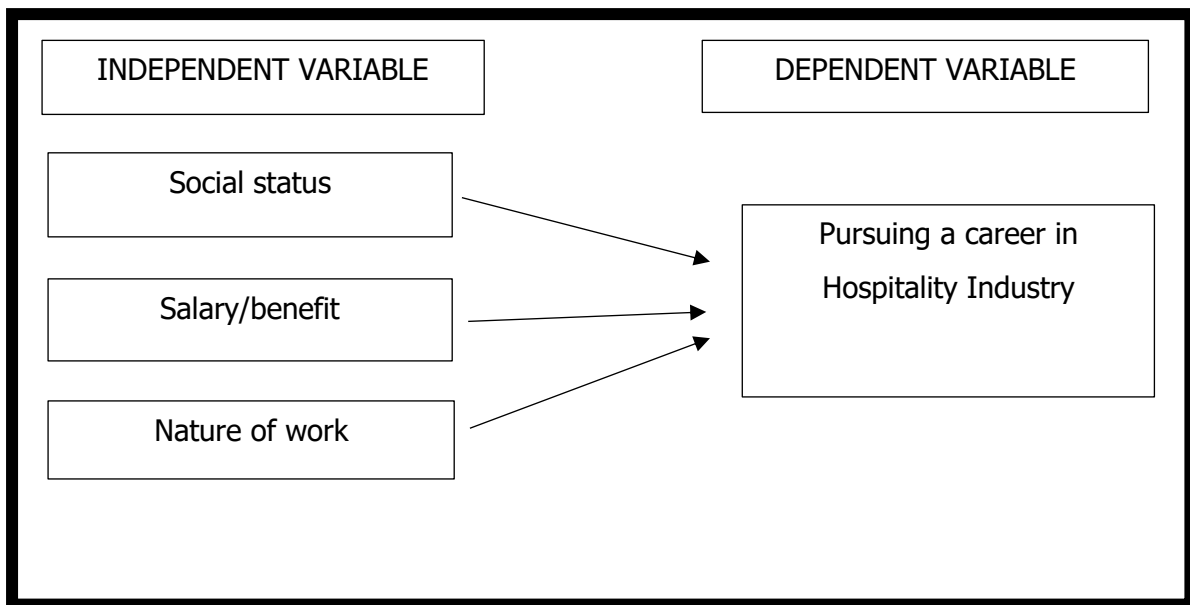

This shows through a summary related studied, the conceptual framework of factors that had influenced in pursuing a career in hospitality industry. This studied was determined by the social status, salary/benefit, and nature of worked.

## METHODOLOGY

### Research Design

In general, a strategic structure that links research themes to its execution is referred to as research design. Study design is a set of rules for configuring data collecting and analysis settings in a way that balances relevance to the investigation goal with the research's purpose (Durrheim, 2006). There are both quantitative and qualitative approaches. Quantitative approach is a technique of collecting, analyzing, interpreting, and writing the data that the researcher got for the study (Carrie, 2002). The approach of using quantitative will aid the research in obtaining data through the responding to relational questions of variables in study. Meanwhile, qualitative approach is entails gathering and analyzing narratives using methods such as interviews or group focus. Qualitative approach also used for researcher in-depth understanding about human behavior, experience, attitudes, and intentions (Shariques, 2019).

The study's main objective was to examine the factors that have influenced final year students' university Malaysia Kelantan in pursuing a career in the hospitality industry. The researcher utilized a quantitative strategy to gather data for this study, this is because, to predict the results based on the hypothesis and formulate a plan to test the research predictions which are factors that affect careers in the hospitality industry for final year students at UMK. Quantitative data was collected via a questionnaire. The quantitative approach to understanding behavior entails the use of mathematical techniques, measurement, and research. This design, on the other hand, uses a data point to explain a given reality. The data is collected to determine the link between the independent variable (social status, salary/benefit, and nature of work) and the dependent variable (factors that have influenced in pursuing a career in hospitality industry). Quantitative approaches are widely used to conduct studies that call for a description of trends or an explanation of the relationship between independent and dependent variables. The analysis

obtained will provide information among students at University Malaysia Kelantan in terms of gender, ethnic and socioeconomic status.

### **Data Collection**

According to Shamoo & Resnik (2003), several analytical procedures provide data collection methods in research projects. Primary data are used in this study. The primary data, which is the best kind of data in the research, is often acquired from the source where the original statistics are received. Primary data is information that researchers have collected directly from the source through experiments, surveys, and interviews. The best type of data for the study is considered to be primary data, which is frequently obtained from the same sources as the original statistics.

A questionnaire administered via Google Form was utilized in this investigation. During this situation, questionnaire is used to collect information on the factors of the study such as social status, salary/benefits and nature of work that have influenced final year students in University Malaysia Kelantan (UMK) in pursuing a career in the hospitality industry. The questionnaire is supplied online and collects final year students in the hospitality industry data. Online surveys were conducted since it would be simpler for researchers to gather replies from University Malaysia Kelantan (UMK) final year student respondents about pursuing a profession in the hospitality sector.

### **Sampling**

The sample size was employed in research to estimate the estimated number of participants and to represent a specific sample. The number of participants or observations that were included in a study can also be referred to as the sample size. Each person in the word "example" denotes a subject. The number of subjects in the example made up the test size, which was indicated by the letter "n."

The sample size for any relationship survey research project should not be less than 30. Then, for causal-comparative and experimental study, more than 50 samples were required. Each significant subgroup of the population should have 50 samples chosen, and each minor subgroup should have 20 to 50 samples chosen.

The term "sample size" in this research refers to the number of participants who were chosen from the general sample and considered based on the sample of a specific study. Following the selection of the population by the researcher, the necessary sample size was calculated using those tables. As a result, the sample size for this study was based on a 118-person sample of all hospitality final-year students at the University Malaysia Kelantan Campus Kota, in accordance with (Krejcie and Morgan's chart from 1970).

According to information from the Faculty Hospitality, Tourism, and Wellness, there were 170 students in the hospitality major who were in their last year. Consequently, a total of 170 students had been included in this studied as respondent. Consequently, the studies' sample size would only been 118 people from the total population. This was because according to the table below that was source (Krejcie and Morgan, 1970). As a conclusion, the importance of this sample size was that researched results were directly influenced by sample size calculations.

<i>N</i>	<i>S</i>	<i>N</i>	<i>S</i>	<i>N</i>	<i>S</i>
10	10	220	140	1200	291
15	14	230	144	1300	297
20	19	240	148	1400	302
25	24	250	152	1500	306
30	28	260	155	1600	310
35	32	270	159	1700	313
40	36	280	162	1800	317
45	40	290	165	1900	320
50	44	300	169	2000	322
55	48	320	175	2200	327
60	52	340	181	2400	331
65	56	360	186	2600	335
70	59	380	191	2800	338
75	63	400	196	3000	341
80	66	420	201	3500	346
85	70	440	205	4000	351
90	73	460	210	4500	354
95	76	480	214	5000	357
100	80	500	217	6000	361
110	86	550	226	7000	364
120	92	600	234	8000	367
130	97	650	242	9000	368
140	103	700	248	10000	370
150	108	750	254	15000	375
160	113	800	260	20000	377
170	118	850	265	30000	379
180	123	900	269	40000	380
190	127	950	274	50000	381
200	132	1000	278	75000	382
210	136	1100	285	100000	384

Note: N is population and S is the sample size

Figure 1: Table for selecting the appropriate size of the population sample (Source Krejcie and Morgan, 1970)

### Data Analysis

Data analysis is a mechanism for processing research data utilizing logical techniques to organize, systematize, and turn massive amounts of acquired data into understandable components that deduce a conclusion. The method employed by researchers to study the numbers in quantitative research, where the data is expressed as numerical figures, is a statistical analysis that aids in the development of crucial intuitions. When doing research trials, several stages must be followed. In a nutshell, it is a process that involves the use of statistical practices in the compilation, description, representation, evaluation, and interpretation of data. As a result, it is critical to have a clear knowledge of the research's objectives when doing the analysis. As a result, descriptive analysis is a frequently employed technique in quantitative approaches. The researchers also employed the SPSS version of the study to investigate statistical data analysis. When it comes to data entry and analysis, SPSS is a program-based window that allows you to generate tables and pie charts for data entry and analysis. Researchers collect data for this study's data analysis, including frequency analyses, descriptive analyses, correlation analyses, and reliability analyses, among other procedures.

### FINDINGS

The respondents' background attributes make up the content of this distribution of respondents. Descriptive statistics that include frequency and percentage are used to analyse it. Table 1 show the result of frequency analysis:

Table 1 Frequency Analysis

Categories	Frequency(N)	Percentage (%)
<b>Gender</b>		
Male	95	76.7
Female	28	22.6
<b>Race</b>		
Chinese	5	4.0
Indian	5	4.0
Malay	109	87.9
Other	4	3.2
<b>Age</b>		
21 years old	3	2.4
22 years old	16	12.9
23 years old	45	36.3
24 years old	58	46.8
21-30 years old	1	0.8
<b>Marital status</b>		
Married	8	6.5
Single	115	92.7
<b>Have you ever worked in hospitality industry?</b>		
No	56	45.2
Yes	67	54.0

### Demographic Analysis

Based on the result from table above, the table shows the gender distribution of the respondents. The total respondents are 124 respondents. In this study, the female respondents were higher with 76.7% (N=95) respondents as compared to 22.6% (N=28) for male respondents. The race distribution among the respondents is seen in table above with 87.9 percent (N=109) respondents, Malay is the race group with the most participants in the survey, followed by Chinese and Indian which share the same percentage which is 4.0% (N=5) respondents. And the last group race is other, that followed with 3.2% (N=4) respondents. Table shows the age distribution. The respondents were allocated into five age groups. The highest number of respondents were from the group age of 24 with 46.8% (N=58) respondents and then followed by the group age of 23 with 36.3% (N=45) respondents. The third highest group is 22 years old with 12.9% (N=16) respondents and then followed by group age 21 years old with 2.4% (N=3) respondents. And lastly is group age of 21-30 with 0.8% (N=1) respondents. The percentage of respondent's marital is shown in table 4.1. The highest percentage of respondents that is single is 92.7 percent (N=115). And the lowest percentage is married which is with percentage 6.5% (N=8) respondents. Based on the result from table 4.1, the table shows who's have ever work at hospitality industry of the respondents. The total respondents are 124 respondents. In this study, respondents that have worked is 54.0% (N=67) respondents as compared to 45.2% (N=56) for respondents who have never worked.

## Descriptive analysis

Table 1 Descriptive Analysis

Variable	Items	Mean Score	Standard Deviation
<b>Social Status</b>	I talk to my friend with pride about my future career in hospitality industry	3.72	.854
	Working in hospitality industry is regarded as an important and beneficial service to society	2.95	1.360
	There are good opportunities for promotion and advancement in hospitality industry	3.12	1.265
	Hospitality staff are valued in the society	3.87	.757
	I believe that my personality and character fits well with the type of jobs in the industry	3.88	.685
	I believe that I will get an opportunity to use my skills and abilities working in the industry	4.05	.688
	<b>Salaries and Benefits</b>	Hospitality industry offering a good starting salary	3.86
Working hours are too long in the hospitality industry		3.09	1.201
Considering long hours worked pay should be higher		4.37	.729
Staff meals is an important in the salary package		4.21	.727
I can earn a high income during this hospitality career		3.91	.768
<b>Nature of Work</b>		I find jobs in hospitality industry interesting	4.07
	I think that jobs in hospitality are worth doing	4.00	.658
	Considering the working hours and workload pay is good in hospitality industry	3.93	.737
	Jobs in the hospitality industry are challenging	4.17	.686
	Am happy to tell other that I am training to work in hospitality	4.05	.711
	I believe that hospitality work is very stressful and pressured	3.91	.859
	I can make a friend easily with people working in hospitality	4.02	.741

	Physical working condition generally good in hospitality industry	4.00	.747
<b>Pursuing a career in Hospitality Industry</b>	I strongly believe that whatever I learn in this course will be useful in my future career	4.17	.721
	I strongly believe I knew enough about the hospitality industry before I chose this course	3.89	.777
	I think hospitality courses offer more practical skill training than academic work	4.08	.731
	I chose this industry because of the opportunities to travel overseas	3.83	.875
	One can get ahead in hospitality industry without having high level of education	3.81	.853
	Opportunities for employment in hospitality industry is high	4.07	.770
	Hospitality industries give opportunities to meet and communicate with different people	4.26	.571
	I believe that hospitality industry offers a flexible work	3.93	.856

Table 2 showed the analysis of the mean and deviation of the standard on independent and dependent variables. 'I believe that I will get an opportunity to use my skills and abilities working in the industry' scored the greatest mean value, which was 4.53, where the respondents agreed that social status of 'I believe that I will get an opportunity to use my skills and abilities working in the industry' motivated respondents in pursue a career in the hospitality sectors. Meanwhile, the lowest mean was 'working in hospitality industry is regarded as an important and beneficial service to society' with the mean value 2.95, where respondents slightly agreed that this 'working in hospitality industry is regarded as an important and beneficial service to society' motivated respondents in pursuing a career in the hospitality sectors. Next, 'considering long hours worked pay should be higher' has recorded the highest mean value, which was 4.37, where the respondents agreed that salaries and benefits of 'considering long hours worked pay should be higher' motivated respondents in pursue a career in the hospitality sectors. Meanwhile, the lowest mean was 'working hours are too long in the hospitality industry' with the mean value of 3.09, where the respondents agreed that salaries and benefits of 'working hours are too long in the hospitality industry' motivated respondents in pursuing a career in the hospitality industry.

Besides that, 'jobs in the hospitality industry are challenging' has recorded the highest mean value, which was 4.17, where the respondents agreed that nature of work of 'Jobs in the hospitality industry are challenging' motivated respondents in pursue a career in the hospitality industry. Meanwhile, the lowest mean was 'I believe that hospitality work is very stressful and pressured' with the mean value of 3.91, where the respondents agreed that nature of work of 'I believe that hospitality work is very stressful and pressured' motivated respondents in pursuing a career in the hospitality industry. Lastly, 'hospitality industries give opportunities to meet and communicate with different people' has recorded the highest mean value, which was 4.26, where the respondents agreed that nature of work of 'Hospitality industry give opportunities to meet and communicate with different people' motivated respondents in pursuing a career in the hospitality industry. Meanwhile, the lowest mean was 'One can get ahead in hospitality



industry without having high level of education' with the mean value of 3.81, where the respondents agreed that nature of work of 'one can get ahead in hospitality industry without having high level of education' motivated respondents in pursuing a career in hospitality industry.

### **Result of Reliability Analysis**

Table 3 below shows the result of reliability analysis.

*Table 2 Reliability Analysis*

<b>Construct</b>	<b>Cronbach's Alpha</b>	<b>No of Item</b>	<b>N</b>
Social Status	0.876	6	30
Salaries and Benefits	0.954	5	30
Nature of Work	0.930	8	30
Factor that has Influenced a Career in Hospitality Industry	0.789	8	30
<b>All Variable</b>	<b>0.910</b>	<b>27</b>	<b>30</b>

This table shows evidence about the dependability of four factors. Cronbach's alpha was applied to investigate the consistency of the 27 items, which served as a measurement of the four different constructs. The coefficients of all the constructs from unacceptable to good according to the results. Furthermore, the result was above 0.7 indicating that this questionnaire could be disseminated, and the surveyed could proceed. According to the statistics, the coefficient for salaries and benefits had the highest coefficient with a result of reliability testing of 0.954 (excellent), while the coefficient for factor that had influenced a career in hospitality industry had been found have been the lowest at 0.789 (acceptable).

### **Result of Person Correlation Analysis**

Table 4 below shows the Pearson Correlation Analysis.

Table 3: Pearson Correlation Analysis

Hypothesis	P – Value	Result (Supported/ Not Supported)
H <sub>1</sub> : There is significant relationship between social status and factor that have influenced in pursuing a career in hospitality industry.	0.199	H <sub>1</sub> is supported
H <sub>2</sub> : There is significant relationship between salary/benefit and factor that have influenced in pursuing a career in hospitality industry.	0.000	H <sub>2</sub> is supported
H <sub>3</sub> : There is significant relationship between nature of work and factor that have influenced in pursuing a career in hospitality industry.	0.000	H <sub>3</sub> is supported

The table showed the results of the correlation between the variables, DV which was pursuing a career in hospitality industry and IV which were social status, salaries and benefits and nature of work. The (p-value) of social status was 0.199, which is higher than the highly significant level .0001. In addition, with this hypothesis was accepted where there is a relationship between social status and factor that have influenced in pursuing a career in hospitality industry is significant. The (p-value) of salaries and benefits was 0.000, which was less than the highly significant level .0001. In addition, with this hypothesis was accepted where there is a relationship between salary/benefit and factor that have influenced in pursuing a career in hospitality industry is significant. The (p-value) of nature of work was 0.000 which was less than the highly significant level .0001. In addition, this hypothesis was accepted where there is a relationship between nature of work and factor that have influenced in pursuing a career in hospitality industry is significant. Based on the findings, every hypothesis was confirmed and turned into a factor that influenced the decision to pursue a career in the hospitality industry.

## DISCUSSION & RECOMMENDATIONS

The reliability test was conducted about 123 respondents by using online survey method which is in google form. It has been tested with Pearson Correlation Coefficient that range between 0.117 for status value, followed by salary/benefit were the medium range which is 0.511 and nature of work reaches the highest range value of 0.709. all variables have reached a minimum of internal consistency because of a range of values greater than 0.6.

The nature of work had the highest mean value in the descriptive analysis for the independent variables, at 4.0184, followed by salary/benefits, at 3.8894. 3.5976 was the dependent variable's lowest mean value. The nature of work had the most influence on final-year students at University Malaysia Kelantan to pursue a career in the hospitality industry among the independent variables.

Only students in the last year of the hospitality programme at University Malaysia Kelantan (UMK) were the subject of this study. It is now possible to pinpoint the elements that motivated

people to pursue their career. Additionally, the research is an ongoing examination that might take place at the survey site, in several conditions, or with various goals. This is due to the likelihood that the investigation would produce unexpected findings.

The availability of a sample with a bigger size, on the other hand, suggests that it will be simpler and more likely to elicit a reaction from the public. Because of this, future researchers will need to expand their sample size to further boost the study's precision and dependability. In conclusion, adopting the interview method will increase the researcher's chances of receiving a high response rate. This approach therefore has the potential to less confusion and result in more precise study outcomes.

## CONCLUSION

In conclusion, this study was conducted to find out the factor that have influenced final years student in University Malaysia Kelantan to pursuing a career in the hospitality industry. Three independent variables were studied that is social status, salary/ benefit and nature of work were selected to study their relationship with the dependent variable, pursuing a career in hospitality industry among final year student in University Malaysia Kelantan. A total of 123 respondents aged 21 years old and above were selected from FHPK in hospitality course students at UMK. Overall, based on Pearson Correlation analysis, nature of work has a value of \*0.709, followed by salary/benefit which is \*0.511, and status value at \*0.117.

## REFERENCES

- 10 Reasons To Work In Hospitality. (2021, November 10). RAD Group. <https://radhotelgroup.com/blog/10-reasons-to-work-in-hospitality/>
- Ahmad, R., Rashid, B., & Shariff, N. M. (2014). Malaysian hospitality industry: graduates' justifications for leaving the industry. *Ijms*, 21(2), 1–20.
- Akter, M., Sadekin, M. N., & Patwary, A. K. (2020). An Empirical Study on Students' Satisfaction from Mawlana Bhashani Science & Technology University, Bangladesh. *Review of Economics and Development Studies*, 6(2), 363-379.
- Alom, S., Patwary, A. K., & Khan, M. M. H. (2019). Factors affecting the turnover intention of Bangladeshi migrants in the United Arab Emirates: An empirical study on the hotel industry. *International Journal of Innovation, Creativity and Change*, 8(3), 344-360.
- Ashton, A.S. (2017), How human resources management best practice influence employee satisfaction and job retention in the Thai hotel industry, *Journal of Human Resources in Hospitality and Tourism*, Volume 17, Issues 2
- Australia's National Career Information Service. (n.d.). Myfuture. <https://myfuture.edu.au/career-articles/details/what-are-the-benefits-of-work-experience>
- Bamford, K. (2012). Undergraduate student perceptions of a career in the tourism and hospitality industry in New Zealand University of Otago].
- Boella, M. J., & Goss-Turner, S. (2013). *Human Resource Management in the Hospitality Industry: A Guide to Best Practice*. New York, NY: Taylor & Francis Group.
- Brown, E.A., Thomas, N.J and Bosselman, R.H. (2015). Are they leaving or staying: A qualitative analysis of turnover issues for Generation Y hospitality employees with a hospitality education, *International Journal of Hospitality Management*, Volume 46, Pages 130-137?

- Dillman, D.A., 2007. *Mail and Internet Surveys: The Tailored Design Method*, second ed. John Wiley & Sons, Inc, Hoboken, New Jersey.
- El-Dief, M., & El-Dief, G. (2019). Factors affecting undergraduates' commitment to career choice in the hospitality sector: Evidence from Saudi Arabia. *Journal of Human Resources in Hospitality & Tourism*, 18(1), 93-121.
- Farmaki, A. (2018). Tourism and hospitality internships: A prologue to career intentions? *Journal of Hospitality, Leisure, Sport and Tourism Education*, Volume 23, Pages 50-58
- Fengmin, Z., Baijun, W., Jiangtao, B., Li, L., & Patwary, A. K. (2022). Investigating revisit intention of medical tourists in China through nutritional knowledge, perceived medical quality, and trust in the physiologist: A recommendation on health tourism policy measures. *Frontiers in Public Health*, 10, 893497.
- Ghuangpeng, S. (2011). *Factors influencing career decision-making: a comparative study of Thai and Australian tourism and hospitality students* [Victoria University].
- Grobelna, A., & Dollot, A. (2018), The Role of Work Experience in Studying and Career Development in Tourism: A Case Study of Tourism and Hospitality Students from Northern Poland, *Entrepreneurial Business and Economics Review*, Vol. 6, No. 4
- Gunz, Hugh & Heslin, Peter. (2005). Reconceptualizing Career Success. *Journal of Organizational Behavior*. 26. 105-111. 10.1002/job.300.
- Hazbar, A. M. H., Alem Mohammed, A., & Karim, A. K. A. (2019). An Empirical Study of Factors Influencing hotel customers' online booking Intention. *مجلة العلوم التربوية و الدراسات الإنسانية*, (5), 1-17.
- Joo-ee, G. (2015). Minimum wage and the hospitality industry in Malaysia: An analysis of employee perceptions. *Journal of Human Resources in Hospitality & Tourism*, 15(1), 29-44. <https://doi.org/10.1080/15332845.2015.1008396>
- Le, AH., McDonald, CV., & Klieve, H. (2018), Hospitality Higher Education in Vietnam: Voices from Stakeholders, *Tourism Management Perspectives*, Volume 27, Pages 68-82
- Li, L., Ragavan, N. A., Patwary, A. K., & Baijun, W. (2022). Measuring patients' satisfaction toward health tourism in Malaysia through hospital environment, nutritional advice, and perceived value: A study on Chinese exchange students. *Frontiers in public health*, 10, 893439.
- Li, L., Wu, B., & Patwary, A. K. (2022). How marine tourism promote financial development in sustainable economy: new evidences from South Asia and implications to future tourism students. *Environmental Science and Pollution Research*, 29, 1155-1172.
- Li, L., Wu, B., & Patwary, A. K. (2022). The psychosocial factors affecting chinese Outbound Exchange and mobility students' academic performance during COVID-19. *Frontiers in psychology*, 13, 872516.
- McQuaid, R. & Bond, S. (2003). Gender stereotyping of career choice. [www.careers-scotland.org.uk](http://www.careers-scotland.org.uk) accessed on 17th October 2011.
- Morton, D.L. (2002) Targeting Generation Y. *Public Relations Quarterly* 47(2), 46-48.
- Mukesh Kumar, S. A. (2013). What is Research Method. In S. A. Mukesh Kumar, *Business Research Method*. Shah Alam, Selangor: Oxford Fajar.
- Patwary, A. K., Roy, B., Hoque, R., & Khandakar, M. S. A. (2019). Process of developing a community based tourism and identifying its economic and social impacts: An Empirical study on Cox's Bazar, Bangladesh. *Pakistan Journal of Humanities and Social Sciences*, 7(1), 1-13.
- Research: A Critical Review and Agenda for Future Exploration". *Journal of Management*. 35

- Richardson, S. (2009). Undergraduates' perceptions of tourism and hospitality as a career choice. *International Journal of Hospitality Management*, 28(3), 382-388.
- Richardson, S. (2009). Understanding Generation Y's attitudes towards a career in the industry. In (pp. 131-142). CABI. <https://doi.org/10.1079/9781845936013.0131>
- Roney, S. A., & Oztin, P. (2007). Career perceptions of undergraduate tourism students: A case study in Turkey. *The Journal of Hospitality Leisure Sport and Tourism*, 6(1), 4-17.
- Sincero, S. M., & Sincero, S. M. (n.d.). Methods of Survey Sampling - What sampling method should you use? <https://explorable.com/methods-of-survey-sampling>
- Singh, S. (2018, December 25). Sampling Techniques - Towards Data Science. Medium. <https://towardsdatascience.com/sampling-techniques-a4e34111d808>
- Suhaili, B. M. (2012). „Minimum wage policy will hit hotels hard“. Borneo Post Online. Retrieved from <https://www.theborneopost.com/2012/09/1>
- Sumethokula, P., Patwary, A. K., Srinuanpanc, B., Srinuanpand, C., Suwandee, P., Thammathikul, A., & Phanong, W. (2020). The potential of new tour repackaging for creative tourism among entrepreneurs in Nakhon Si Thammarat. *International Journal of Innovation, Creativity and Change*, 13(10), 1752-1771.
- Wang, S., & Huang, X. (2014). College students' perceptions of tourism careers in China: Wang, S., Liu, S., Wang, J., Tahir, S., & Patwary, A. K. (2021). Assessing the mechanism of energy efficiency and energy poverty alleviation based on environmental regulation policy measures. *Environmental Science and Pollution Research*, 28, 40858-40870.
- Wu, B., Zhai, B., Mu, H., Peng, X., Wang, C., & Patwary, A. K. (2021). Evaluating an economic application of renewable generated hydrogen: A way forward for green economic performance and policy measures. *Environmental Science and Pollution Research*, 1-15.

# **CUSTOMER SATISFACTION OF THE AIRLINES IN SULTAN ISMAIL PETRA AIRPORT, KOTA BHARU KELANTAN**

**Nurul Najwa Binti Othman, Nik Ahmad Lutfilhadi Bin Ab Rahman, Muhammad Ramzi  
Bin Harun, Nur Putri Ai'syahtun Balqish Bt Sanusi & \* Mr. Mohammed Ruqaimi Bin  
Remeli**

*Faculty of Hospitality, Tourism and Wellness, Universiti Malaysia Kelantan  
Corresponding email: [ruqaimi@umk.edu.my](mailto:ruqaimi@umk.edu.my)*

## **ABSTRACT**

This study aimed to examine about customer satisfaction of Malaysia airlines industry. According to media sources and public knowledge, Kota Bharu Airport may suffer certain issues. Flight delays can be brought on by a few things, including inclement weather, mechanical issues with the aircraft, or logistical issues with the airport. The objective of the study in the research attempted, to examine the relationship between services quality of Malaysia Airlines Industry. According to Krejcie & Morgan (1970)'s sample size table 200 respondents will be chosen from the population. Most of the questions asked focus on the factors that have influenced in determining the level of customer satisfaction in terms of price, airport environment and service in influencing customer satisfaction towards airlines industry. All improvements also need to be taken seriously in terms of service and environment there. Finally, some other determinants are recommended to be included in the research and obtain further reasoning.

**Keywords: Airlines Industry; identity: Customer satisfaction in the airlines industry.**

## **INTRODUCTION**

This study aimed to examine about customer satisfaction of Malaysia airlines industry. Making this study it started with basic information in chapter 1. This chapter has flow of the chapter such as background of the study, problem statement, research objective, research's question, significant of study, definition of terms and the last one is summary.

Chapter 2 gives a summary of earlier study aimed to examine about customer satisfaction of Malaysia airlines industry. This chapter has flow of the chapter such as background of the study, problem statement, research objective, research's question, significant of study, definition of terms and the last one is summary.

This chapter 3 discusses analysis methodologies. In general, describes the type of analysis needed to complete the case study. The research methodology used to complete this report includes research design, population, sample size, sampling method, data collection procedure, research instrument, data analysis, and summary.

## **SIGNIFICANT STUDY**

Malaysia Airlines had been declared closed during the COVID-19 pandemic, but in 2022, it and MAS returned by offering affordable ticket prices for customers to fly abroad. This study offered advantages to future researchers to learn more about the Malaysia Airlines industry. The airline company expanded quickly, with a notable rise in worldwide airline profits from USD6.1 billion in 2011 to USD10.6 billion in 2012.

The dependent variable analyzed by the researcher was customer satisfaction in the Airlines industry. The dependent variable depended on other factors that were measured.

The independent variable, which was thought to have a direct impact on the dependent variable, included service quality, prices, and the environment of the airport. The experimenter manipulated or modified the independent variable, which was the cause.

To measure service quality thoroughly, the researcher created ten components of service quality, including tangibles, reliability, responsiveness, understanding of consumers, access, communication, and credibility.

## **LITERATURE REVIEW**

### **Service Quality**

The concept of service quality had been defined as the discrepancy between what customers expected from a service and how they experience it. Service quality had previously been defined as how well a service met the demands or expectations of customers. It could also be thought of as the consumer's general perception of the services' relative quality or inferiority. In recent years, it had become widely accepted that client ratings of a service determine its quality. The general rationale was cleared because the customer's opinion affects his or her future actions, such as returning the next time or giving favorable reviews to family members. This shows that service providers could not only provide services in accordance with internal standards, which may not meet customers' expectations.

### **Airport Environment**

The airport environment refers to the physical and operational characteristics of an airport, including its facilities, infrastructure, services, and activities. The airport environment encompasses everything from the runways, terminals, and aircraft parking areas, to the security checkpoints, retail shops, and restaurants. It also includes the various operational components such as air traffic controller, baggage handling systems, fueling and maintenance facilities, and ground handling services. The airport environment was designed to ensure the safe and efficient movement of aircraft, passengers, and cargo, and to provide a comfortable and convenient experience for travelers.

### **Price**

Price generally refers to the amount of money that was required to have been paid in order to acquire or use a particular product or service. It was the value assigned to a product or service in exchange for its perceived utility or benefit. Price could be influenced by a range of factors, including production costs, supply and demand, competition, and marketing strategies. A higher price may reflect a higher perceived value, greater quality, or scarcity of the product or service. Conversely, a lowered price may indicate lowered quality or lowered demand. In business and economics, pricing strategies played an important role in determining the success of a product or service. Pricing decisions were often based on a combination of market research, consumer behavior analysis, and competitive analysis, and could have had a significant impact on a company's profitability and market position.

## **Customer Satisfaction Towards Airlines Industry**

Customer satisfaction towards the airline industry refers to the leveled of contentment or happiness that customers experience when used the services of airlines. It was a measured of how well the airlines met or exceed the expectations of their customers in terms of service quality, safety, comfort, convenience, reliability, and affordability. Customer satisfaction was a critical factor in the success of the airline industry. Satisfied customers were more likely to use the airline's services again, recommend it to others, and positively promote the airline's brand image. On the other handed, dissatisfied customers may lead to negative word-of-mouth, reduce customer loyalty, and ultimately harm the airline's reputation and revenue. To measured customer satisfaction, airlines may use various tools, including surveys, feedback forms, social media analytics, and customer service interactions. By understanding their customers needed and preferences, airlines could improve their services, enhance their customer experience, and ultimately achieve higher levels of customer satisfaction.

### **Research Hypothesis**

The hypothesis of the researcher was made based from the factor that studied such as quality of service airlines, customer satisfaction and price towards mas and airasia at Pengkalan Chepa, Kota Bharu kelantan. The following hypothesis was developed and was have been evaluated based on the studied.

H1: There was significant relationship between social status and factors that had influenced in pursuing a career in hospitality industry.

H2: There was significant relationship between salary/benefit and factors that had influenced in pursuing a career in hospitality industry

H3: There was significant relationship between nature of work and factors that had influenced in pursuing a career in hospitality industry.

### **Research Framework**

A conceptual framework shows how variables should be related to one another. It outlines how the researcher method' pertinent objectives fit together to provide logical findings. Based on the examination of the literature review, the researchers have put out a framework. Therefore, below is a conceptual framework



Table 2.4.1 Conceptual Framework (Suki, 2014)

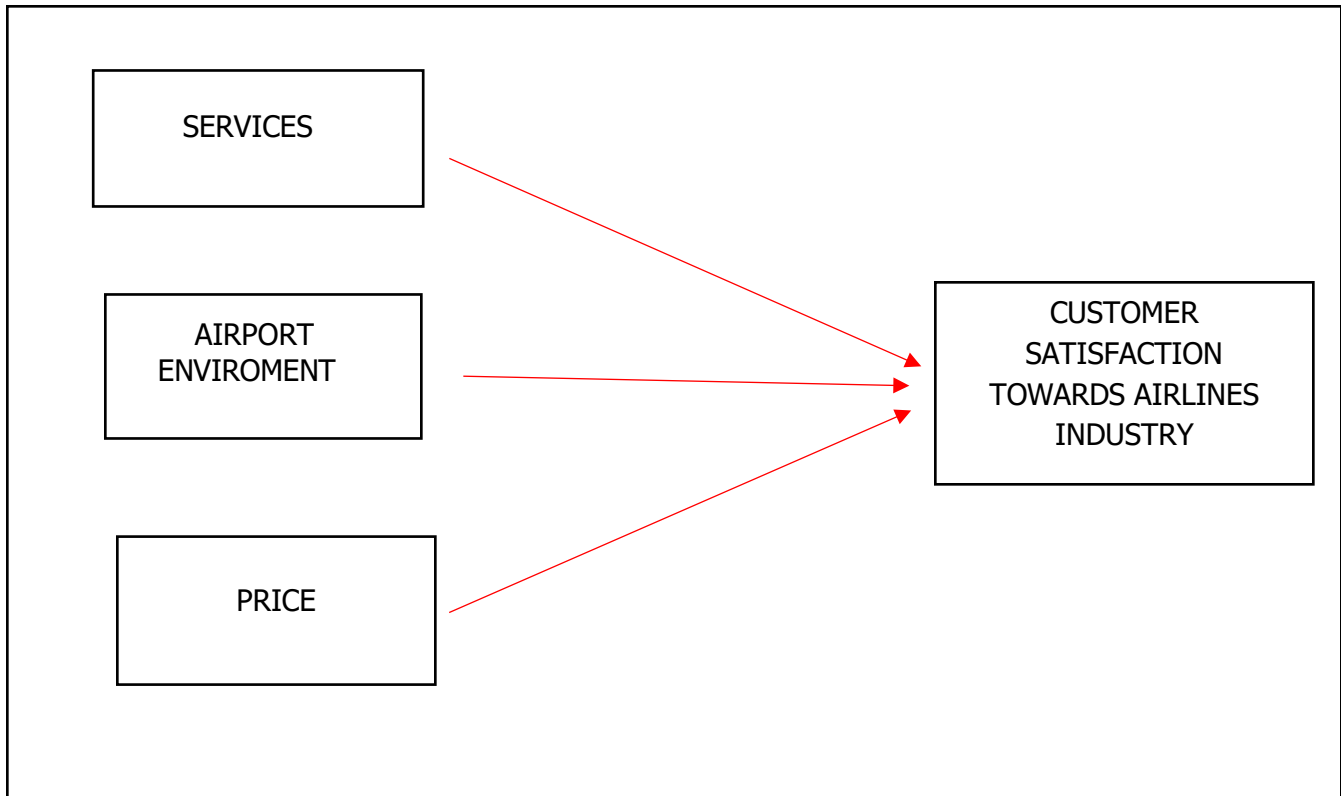

Based on table 2.4.1 from conceptual framework, the researcher has studied the relationship between independent variable and dependent variable.

## **METHODOLOGY**

### **Research Design**

The research design is the overall approach that the researcher chooses to combine the many study components in a logical and cogent manner, as well as serve as the guide for the data gathering, measurement, and analysis processes. The questionnaire used in this study was created after a thorough examination of the literature review and based on data collected during focus group interviews. Quantitative is used in the study to gain all data through questionnaire, while qualitative is about describes attributes or features. The researcher has chosen the quantitative approach of their research to understand and determine between independent variable (service, airport environment and price) and dependent variable (customer satisfaction towards airlines industry). The survey Questionnaire was set the filling of the area around Pengkalan Chepa Kota Bharu, Kelantan, and respondents came from a variety of ethnicity, ages, genders, and marital statuses. This survey was conducted in the Kota Bharu, Kelantan using google form.

## Data Collection

This study investigates how Malaysia Airlines' customer satisfaction levels are affected by service quality, targeting passengers who have recently travelled with the airline. (Farooq et al., 2018). Sultan Ismail Petra Airport Kelantan was chosen for a study on customer satisfaction towards the airlines industry due to its large population and stimulating and satisfying service offered to customers. The study was chosen to find out customer satisfaction in using airline industry services, as well as to find out customer satisfaction in using airline industry services.

The coronavirus pandemic has caused a 50% decline in worldwide aviation passenger volume, with just over 2.2 billion passengers on scheduled flights in 2021. This is compared to 2019, when the number of scheduled passengers handled by the world's airlines has climbed. The Asia Pacific region had the highest percentage of airline passenger traffic in 2019, with the busiest aviation routes found in this area.

## Sampling

The sampling technique entails gathering individuals wherever they can be found, usually wherever it is convenient. The two categories of sampling techniques are probability and non-probability. Case study research design is typically associated with non-probability sampling, while probability sampling suggests that each item in the population has an equal chance of being included in the sample. The researchers chose the study participants using a convenience sampling technique, a non-probability. Examples of convenience sampling include simple accessibility, geographic closeness, availability at a specific time, or eagerness to participate. Additionally, the term "convenient sampling" can also apply to "accidental samples" since the sample's constituent parts could be randomly selected based on their proximity to the researchers undertaking the data collection or their administrative location. This approach is appropriate for this study since the respondents will provide the researcher with the unknown data.

Table 3.1: Sample Size of Known Population

N	S	N	S	N	S	N	S	N	S
10	10	100	80	280	162	800	260	2800	338
15	14	110	86	290	165	850	265	3000	341
20	19	120	92	300	169	900	269	3500	346
25	24	130	97	320	175	950	274	4000	351
30	28	140	103	340	181	1000	278	4500	354
35	32	150	108	360	186	1100	285	5000	357
40	36	160	113	380	191	1200	291	6000	361
45	40	170	118	400	196	1300	297	7000	364
50	44	180	123	420	201	1400	302	8000	367
55	48	190	127	440	205	1500	306	9000	368
60	52	200	132	460	210	1600	310	10000	370
65	56	210	136	480	214	1700	313	15000	375
70	59	220	140	500	217	1800	317	20000	377
75	63	230	144	550	226	1900	320	30000	379
80	66	240	148	600	234	2000	322	40000	380
85	70	250	152	650	242	2200	327	50000	381
90	73	260	155	700	248	2400	331	75000	382
95	76	270	159	750	254	2600	335	100000	384

Note: N is a population, S is a sample size.

## Data Analysis

Correlation is a statistical term used to indicate a form of association between two variables. The most popular correlation statistic for determining how closely two variables is connected linearly is the Pearson correlation. The strength of the association between 36 two variables that are numerically assessed is studied using the statistical assessment technique known as correlation analysis. It is possible for the correlation coefficient to range from -1.0 to 1.0, and perfect negative correlation is represented by a value of -1.0, and perfect positive correlation is represented by a value of 1.0. Positive correlation is shown by a correlation coefficient over zero, but there is a negative association when the value is less than zero. There is no connection between the two variables if the value is 0.

## FINDINGS

Table 1 below shows the result of frequency analysis.

*Table 1 Frequency Analysis*

CATEGORY	FREQUENCY	PERCENTAGE (%)
<b>GENDER</b>		
Male	83	58.5
Female	116	59.5
<b>RACE</b>		
Bajau	1	1.0
Brunei	1	2.0
Chinese	3	4.5
Iban	3	6.0
India	5	8.5
Jawa	1	9.0
Malay	178	98.0
Orang asli	1	100.0
<b>AGE</b>		
21 years old- 26 years old	144	72.5
27 years old- 32 years old	18	81.5
33 years old - 38 years old	18	90.5
39 years old - 44 years old	7	94.0
45 years old and above	12	100.0
<b>OCCUPATION</b>		
Civil servant	27	14.5
Sailor	1	16.0
Retired	1	16.5
Private staff	36	35.0

Self-employee	37	54.0
Student	90	99.0
Housewife	1	100.0
<b>EDUCATION LEVEL</b>		
Bachelor of degree	113	57.0
Diploma	46	80.0
Doctor of philosophy	1	81.0
Master degree	9	85.5
Secondary school	28	100.0
<b>MONTHLY INCOME</b>		
Below RM2,000	126	66.0
RM2,500 - RM3,500	41	87.0
RM4,500 - RM5,500	17	95.5
RM6,500 - RM7,500	7	99.0
RM8,500 - RM9,500	2	100.0
Above RM10,000	5	3.0
<b>HOW OFTEN DO YOU FLY?</b>		
Once a week	9	99.5
2 or 3 times a month	27	14.5
Once a month	22	95.0
Less than once per month	139	84.0

## Demographic Analysis

### 4.1.1 Gender.

The total number of respondents for male was 83 respondents and for female was 116 respondents. Out of 200 respondents, 40.7% of total respondents were male and the remaining of 58.3% were female respondents who involved in study.

### 4.1.2 Age.

There were respondents who consist of age from 21-26 (144 respondents) (72.4%), 27-32 (18 respondents) (9%), 33-38 (18 respondents) (9%), 39-44 (7 respondents) (9%) and 45 and above (12 respondents) (9%) had responded 41 to the questionnaire.

### 4.1.3 Ethnic Origin.

There were 200 respondents who consist of Malay (178 respondents), Indian (5 respondents), Chinese (3 respondents), Iban (3 respondents), Native Sabahan (1 respondents), Brunei (1 respondents) had responded to the questionnaire. The highest percentage of respondents was Malay (89.4%) and followed by Indian which was (2.5%), and the lowest percentage respondents was Native Sabahan and Brunei which was (0.5%).

### 4.1.4 Occupation.

The total number of respondents for civil servant was 27 respondents equivalent to 13.6%. Total number of respondents for private staff was 36 respondents (18.1%). Total number of respondents for the self-employee was 37 respondents (18.6%). Total number of respondents for students was 90 respondents (45.2%). Total of sailor, retired and housewife were 1 respondent which is 0.5 %.

### 4.1.5 Education Level.

There were 28 respondents from secondary school (14.0%), 46 respondents from diploma (23.0%), 113 respondents from bachelor of degree (56.5%), 9 respondents from master degree (4.5%) and lastly 1 respondent from doctor of philosophy (0.5%). The highest respondent is bachelor of degree meanwhile the lowest respondent was doctor of philosophy.

#### 4.1.6 Monthly Income.

There were 200 respondents who consist below RM2000 were 126 respondents (63%), RM2500-RM3500 were 41 respondents (20.5%), RM4500-RM5500 were 17 respondents (8.5%), RM6500-RM7500 were 7 respondents (3.5%), RM8500-RM9500 were 2 respondents (1.0%) and above RM10000 were 5 respondents (2.5%) had responded to the questionnaire.

#### 4.1.7 How often do you fly.

Once a week had 9 respondents (4.5%), 2 or 3 times a month had 27 respondents (13.6%), once a month had 22 respondents (11.1%), less than once per-month 139 respondent (70.2%) and lasted of the once a week was 1 respondent (0.5%) who consist this study.

### Descriptive Analysis

Table 2 below shows the result of descriptive analysis.

*Table 2 Descriptive Analysis*

<b>Variable</b>	<b>Items</b>	<b>Mean Score</b>	<b>Standard Deviation</b>
<b>Service</b>	Company airlines should take care on issue services about departure time	4.51	.814
	Airlines industry should assure on-time departure and arrival and provide consistent ground/in-flight services	4.42	.726
	Airlines company should ensure the efficiency of catering service, cargo handling and technical maintenance of aircrafts in order to build its image as a reliable and safe airline	4.48	.715
	Polite service and speech affect the quality of flight services.	4.49	.709
	The variety of rules in the plane can reduce the demand for flight	4.02	.910
	Value, brand, and image become an important focus in determining quality in service	4.16	.875
	You have always got help from the airline staff no matter what is the problem	4.12	.834
<b>Airport Environment</b>	Airport should modernize their facilities and High-quality physical airport environment to satisfy their customer	4.39	.782

	The airport must ensure has clean and comfortable interiors and seats	4.51	.757
	The airport has a large parking space and makes it easy for customers to park their vehicles and guarantee the safety of the vehicles	4.39	.873
	Management should consider how physical airport environment that can create favorable emotions so customer became happy passengers and more likely to spend in terminal	4.32	.807
	Airport should find distinctive way to provide service that may delight and satisfy passenger as example by greeting guest in many traditional ways	4.25	.842
	Airport companies need to provide a place to leave customers' belongings when they want to go to the toilet especially for solo travelers	4.41	.777
	The size of the airport in holding passengers is sufficient	4.08	.907
<b>Price</b>	Airlines company should ensure that ticket prices are maintain at the average price of ticket sold by other airlines	4.23	.808
	Airlines management should consider the income level of passengers and define their ticket price considering passenger's buying power	4.22	.771
	Considering in-flight services that this airline offers their best to the customer, they are thinks that they worth what their pay for overall in-flight service quality	4.14	.808
	I do not mind the price increase if the quality is high	3.91	.991
<b>Customer Satisfaction Towards Airlines</b>	The information quality of website has a positive effect on customer satisfaction toward purchasing the ticket	4.23	.776
	Are you satisfied with the quality of services provided from airlines company?	4.02	.811
	Price charging decisions in products or services affect customer satisfaction	4.24	.718
	Managers must understand their customers' needs and then set out to meet and recognize customer needs in order to fulfill	4.29	.692

	expectations to achieve high customer satisfaction during the service		
	I am very satisfying with the facilities provided by the airport	4.30	.962
	Prices offered to customers for products or services influence customer	4.24	.726

#### 4.2.1 IV1- Services

The mean and standard deviation statistics of respondents regarding airline services in Kota Bharu, Kelantan. The most significant mean value was 4.51, indicating airlines should prioritize departure time services. The lowest mean value was 4.02, suggesting a variety of plane rules can reduce flight demand. The higher standard deviation indicates greater data spread.

#### 4.2.2 IV2- Airport Environment

Displays respondents' mean and standard deviation statistics on the airport environment in Sultan Ismail Petra Kota Bharu, Kelantan. The highest mean was 4.51, suggesting clean and comfortable interiors. The lowest mean was 4.08, suggesting sufficient passenger size. The higher standard deviation indicates greater data spread.

#### 4.2.3 IV3- Price

Displays the mean and standard deviation statistics of respondents regarding airline range prices in Sultan Ismail Petra Kota Bharu, Kelantan. The highest mean was 4.23, suggesting airlines should maintain ticket prices at the average price of other airlines. The lowest mean was 3.91, suggesting that customers do not mind price increases if the quality is high. The higher standard deviation indicates greater data spread.

#### 4.2.4 DV- Customer Satisfaction Towards Airlines

Displays customer satisfaction statistics for airlines. The highest mean value was "very satisfied with airport facilities" (4.30), while the lowest was "satisfied with quality of services" (4.02). The higher standard deviation was "very satisfied with airport facilities" (0.962), indicating a wider range of satisfaction.

### Result of Reliability Analysis

Table 3 below shows the result of reliability analysis.

*Table 3 Reliability Analysis*

Construct	Cronbach's Alpha	No of Item	N
Services	0.678	7	30
Airport Environment	0.712	7	30
Price	0.714	4	30
Customer Satisfaction Towards Airlines.	0.761	6	30
<b>All Variable</b>	<b>0.781</b>	<b>24</b>	<b>30</b>

Reliability is the degree to which results are constant over time and a precise representation of the entire population under study, and a research instrument is deemed reliable if the study's findings can be replicated using a similar approach. The term 'Reliability' is a concept used for testing or evaluating quantitative research, the idea is most often used in all kinds of research. The higher and closer the Cronbach's alpha value is, the greater the item's internal consistency is and the more dependable it is for survey purposes.

Pilot Test Result for illustration the overall consistency (pilot test) for the dependent and independent variable. The pilot test was done to 30 respondents before it was distributed to 200 respondents through an online survey method (google form). The pilot test result and showed the construct about the independent variable and dependability variable of four factors. Cronbach's Alpha was applied to investigate the consistency of the 24 items, which served as a measurement of the four different constructs. Furthermore, the result is above 0.7 indicating that this questionnaire can be disseminated and the survey can proceed. According, to the table 4.3.2, the coefficient is the highest value result which was 0.761 (acceptable) and the lowest result was 0.678 (acceptable).

The results of reliability statistics for services. Measuring the customer satisfaction towards airlines, 7 questions were used and analysis. There were shown, the Cronbach's Alpha result for this question was 0.678 which was resulted as acceptable. Therefore, the coefficients obtained for the variables on the social status question are not reliable.

The results of reliability statistics on airport environment at Sultan Ismail Petra, Kota Bharu Kelantan. 7 question was asked to obtain the customer satisfaction towards airlines. The table showed the result Cronbach's Alpha for this question is 0.712 which was acceptable. Therefore, the coefficients obtained for the questions in the ethnicity variables are not reliable.

The result of price 4 questionnaires was asked to the customer to filled up the customer satisfaction towards airlines. The results show that the Cronbach's Alpha for this question is 0.714 which also questionable. Therefore, the coefficients obtained for the questions in nature of work variables are reliable.

In measuring the customer satisfaction towards airlines in Sultan Ismail Petra, Kota Bharu Kelantan, 6 question were use for this section. The Cronbach's Alpha result for this question has got a total of 0.761 which yield as acceptable. Lastly, the coefficients obtained for the independent variable questions are reliable and research can be continued.

## Result of Pearson Correlations

Table 4 below shows the result of Pearson correlation.

*Table 4 Pearson Correlation Analysis*

Hypothesis	Pearson's correlation results
H1: There is a significant relationship between services and customer satisfaction towards airlines.	r = 0.638, p < 0.01 Medium



H2: There is a significant relationship between airport environment and customer satisfaction towards airlines.	$r = 0.628, p < 0.01$	Medium
H3: There is a significant relationship between price and customer satisfaction towards airlines.	$r = 0.768, p < 0.01$	Strong

## DISCUSSION & RECOMMENDATION

To improve customer satisfaction in the Malaysia Airlines industry, here are some recommendations. First, Improve Flight Schedules and On-time Performance. Next, Upgrade In-Flight Services. Then, Strengthen Communication Channels. Effective communication is key to any successful business, including the airline industry. Malaysia Airlines should strengthen its communication channels to keep customers informed about flight delays, cancellations, and other changes. Furthermore, Personalize Customer Experience, Malaysia Airlines should focus on providing a personalized experience to customers. It can be done by identifying customers' preferences, providing customized services, and personalized offers.

Next, Improve Baggage Handling. By improving consumer expectations on the assurances made by the industry, airlines may produce value and use resources more wisely, ultimately improving customer satisfaction.

This can be achieved in several ways, including by exceeding consumer demands for service, successfully resolving customer complaints, and favorably responding to customer complaints. Due to this, management will be able to set their brand different from that of other airlines in terms of customer service. By implementing these recommendations, Malaysia Airlines can significantly improve its customer satisfaction and attract more customers in the long run.

## CONCLUSION

In conclusion, the relationship between service quality, airport environment, price, and customer satisfaction in the airline industry is complex and multi-faceted. While each of these factors plays a significant role in shaping customer perceptions and experiences, their impact on customer satisfaction can vary based on individual preferences and circumstances. Service quality, encompassing factors such as in-flight service, ground staff interaction, and overall customer service, is consistently identified as a critical determinant of customer satisfaction in the airline industry. Airlines that prioritize and deliver exceptional service are more likely to generate positive customer experiences and enhance overall satisfaction levels. The airport environment, including factors such as cleanliness, comfort, and efficiency of airport facilities, also influences customer satisfaction.

## REFERENCE

- Abu Bakar, F. A., Zulkafly, N. Z., Mohamed Rashad, M. H., & Melan, M. (2017). Customer satisfaction towards AirAsia services among UUM student.
- Adisasmita, S. A., & Hadipramana, J. (2011). Improving the airport operation and environmental quality at small airports in indonesia. *International Journal of Sustainable Construction Engineering and Technology*, 2(2).
- Akter, M., Sadekin, M. N., & Patwary, A. K. (2020). An Empirical Study on Students' Satisfaction from Mawlana Bhashani Science & Technology University, Bangladesh. *Review of Economics and Development Studies*, 6(2), 363-379.
- Al Mahmud, S. R. (2020). The effectiveness of Facebook advertisements on purchase intention of customers in Malaysia. *South Asian Journal of Social Sciences and Humanities*, 1(1), 97-104.
- Alom, S., Patwary, A. K., & Khan, M. M. H. (2019). Factors affecting the turnover intention of Bangladeshi migrants in the United Arab Emirates: An empirical study on the hotel industry. *International Journal of Innovation, Creativity and Change*, 8(3), 344-360.
- Amiruddin, N. H. (2013). Price, service quality and customer loyalty: a case of Air Asia. *South East Asia Journal of Contemporary Business, Economics and Law*, 2(1), 34-40.
- Byambaa, B., & Chang, K. (2012). The influence of factors of online purchase on customer satisfaction in Mongolian Airlines. *International proceedings of economics development and research*, 57(15), 80-85.
- Conference on the Applications of Social Sciences and Humanities (TICASH 2019),
- De Castro Carvalho, I., Calijuri, M. L., Assemany, P. P., e Silva, M. D. F. M., Neto, R. F. M., da Fonseca Santiago, A., & de Souza, M. H. B. (2013). Sustainable airport environments: a review of water conservation practices in airports. *Resources, Conservation and Recycling*, 74, 27-36.
- Evanschitzky, H., Baumgarth, C., Hubbard, R., & Armstrong, J. S. Replication Research in Marketing Revisited: A Note on a.
- Farooq, M. S., Salam, M., Fayolle, A., Jaafar, N., & Ayupp, K. (2018). Impact of service quality on customer satisfaction in Malaysia airlines: A PLS-SEM approach. *Journal of air transport management*, 67, 169-180.
- Fengmin, Z., Baijun, W., Jiangtao, B., Li, L., & Patwary, A. K. (2022). Investigating revisit intention of medical tourists in China through nutritional knowledge, perceived medical quality, and trust in the physiologist: A recommendation on health tourism policy measures. *Frontiers in Public Health*, 10, 893497.
- Gures, N., Arslan, S., & Tun, S. Y. (2014). Customer expectation, satisfaction and loyalty relationship in Turkish airline industry. *International Journal of Marketing Studies*, 6(1),
- Hapsari, R., Clemes, M. D., & Dean, D. (2017). The impact of service quality, customer engagement and selected marketing constructs on airline passenger loyalty. *International Journal of Quality and Service Sciences*.
- Hasim, M. A., Shamsudin, M. F., & Ishak, M. F. (2018). Customer satisfaction and purchasing intention in airline service quality: A case study of Malaysia Airlines. *International Journal of Engineering & Technology*, 7(4.29), 150-153.
- Hazbar, A. M. H., alem Mohammed, A., & Karim, A. K. A. (2019). An Empirical Study of Factors Influencing hotel customers' online booking Intention. *مجلة العلوم التربوية و الدراسات الإنسانية*, (5), 1-17.

<https://www.proquest.com/scholarly-journals/quality-seekers-as-moderatingeffectsbetween/docview/2288760639/se-2>

Hutagaol, D. C., & Erdiansyah, R. (2020). The Effect of Service Quality, Price, Customer

*International Review of Management and Marketing*, 9(4), 74-79.

Khan, U., & Khan, N. (2014). Customer satisfaction in airline industry. *International proceedings of economics development and research*, 76, 63.

Khudhair, H. Y., Jusoh, A., Mardani, A., & Khalil Md, N. (2019). Quality Seekers as Moderating Effects between Service Quality and Customer Satisfaction in Airline Industry.

Li, L., Ragavan, N. A., Patwary, A. K., & Baijun, W. (2022). Measuring patients' satisfaction toward health tourism in Malaysia through hospital environment, nutritional advice, and perceived value: A study on Chinese exchange students. *Frontiers in public health*, 10, 893439.

Li, L., Wu, B., & Patwary, A. K. (2022). How marine tourism promote financial development in sustainable economy: new evidences from South Asia and implications to future tourism students. *Environmental Science and Pollution Research*, 29, 1155-1172.

Li, L., Wu, B., & Patwary, A. K. (2022). The psychosocial factors affecting chinese Outbound Exchange and mobility students' academic performance during COVID-19. *Frontiers in psychology*, 13, 872516.

McAfee, R. P., & Te Velde, V. (2006). Dynamic pricing in the airline industry. *Handbook on economics and information systems*, 1, 527-567.

Moon, H., Yoon, H. J., & Han, H. (2017). The effect of airport atmospherics on satisfaction and behavioral intentions: Testing the moderating role of perceived safety. *Journal of Travel & Tourism Marketing*, 34(6), 749-763.

Namukasa, J. (2013). The influence of airline service quality on passenger satisfaction and loyalty: The case of Uganda airline industry. *The TQM Journal*.

Noviantoro, T., & Huang, J.-P. (2022). Investigating airline passenger satisfaction: Data mining method. *Research in transportation business & management*, 43, 100726.

Patwary, A. K., Roy, B., Hoque, R., & Khandakar, M. S. A. (2019). Process of developing a community based tourism and identifying its economic and social impacts: An Empirical study on Cox's Bazar, Bangladesh. *Pakistan Journal of Humanities and Social Sciences*, 7(1), 1-13.

Raditha Hapsari, M. D. C. a. D. D. (2016). The impact of service quality, customer engagement and selected marketing constructs on airline passenger loyalty.

Satisfaction on Customer Loyalty of AirAsia Customers. Tarumanagara International

Setiawan, E., Wati, S., Wardana, A., & Ikhsan, R. (2020). Building trust through customer satisfaction in the airline industry in Indonesia: Service quality and price fairness contribution. *Management Science Letters*, 10(5), 1095-1102.

Suhartanto, D., & Noor, A. A. (2012). Customer satisfaction in the airline industry: The role of service quality and price. Asia Tourism Forum Conference,

Suki, N. M. (2014). Passenger satisfaction with airline service quality in Malaysia: A structural equation modeling approach. *Research in transportation business & management*, 10, 26-

Sukri, S., Abdullah, F., & Waemustafa, W. (2014). Customer satisfaction and loyalty in the airline industry: A case study of Malaysia Airlines (MAS) and Air Asia. International Case Study Conference, Putra World Trade Centre, Malaysia,

- Sumethokula, P., Patwary, A. K., Srinuanpanc, B., Srinuanpand, C., Suwandee, P., Thammathikul, A., & Phanong, W. (2020). The potential of new tour repackaging for creative tourism among entrepreneurs in Nakhon Si Thammarat. *International Journal of Innovation, Creativity and Change*, 13(10), 1752-1771.
- Taherdoost, H. (2016). Sampling methods in research methodology; how to choose a sampling technique for research. *How to choose a sampling technique for research (April 10, 2016)*.
- Wu, B., Liu, S., Wang, J., Tahir, S., & Patwary, A. K. (2021). Assessing the mechanism of energy efficiency and energy poverty alleviation based on environmental regulation policy measures. *Environmental Science and Pollution Research*, 28, 40858-40870.
- Wu, B., Zhai, B., Mu, H., Peng, X., Wang, C., & Patwary, A. K. (2021). Evaluating an economic application of renewable generated hydrogen: A way forward for green economic performance and policy measures. *Environmental Science and Pollution Research*, 1-15.
- Yunus, N. S. N. M., Bojei, J., & Rashid, W. E. W. (2013). Service quality towards customer loyalty in Malaysia's domestic low-cost airline services. *International Journal of eEducation, e-Business, e-Management and e-Learning*, 3(4), 333.

# CUSTOMER PERCEPTION OF MCDONALD'S RESTAURANT SERVICE QUALITY IN KOTA BHARU KELANTAN

*ARULVANI REVINDARAN, ANG YI MING, SITI NURAI SYAH BINTI ABD. GHAFAR  
FAZZRIN AZIRA BINTI ABD AZIZ & \*ENCIK MOHAMMED RUQAIMI BIN REMELI*

*Faculty of Hospitality, Tourism and Wellness University Malaysia Kelantan  
Corresponding email: [ruqaimi@umk.edu.my](mailto:ruqaimi@umk.edu.my)*

---

## ABSTRACT

---

Malaysia's food and beverages sector is now increasingly active, with an increase in local customers. This will also make the food and beverages industry more vibrant. Many local customers make food like McDonald's as their leading food, such as breakfast, lunch, and dinner, especially for customers who work and students. This study aims to see the factors that affect customers' perception of McDonald's restaurant service quality in Kota Bharu, Kelantan. These factors are essential in making customers satisfied with service quality. The study's primary data was collected using a structured questionnaire and analysed using SPSS software. The survey was distributed to 348 respondents from McDonald's customers. The food and beverages industry, such as McDonald's, is overgrowing, providing a variety of menus with reasonable prices and convenience features when dining in. Through this study, the researcher sought to discover more about the factors influencing customers' perception of McDonald's restaurant service quality in Kota Bharu, Kelantan. All factors were significantly associated with service quality in McDonald's with a defined level of association ( $r = 0.543, 0.544$  and  $0.621$ , respectively). The finding has shown a significant relationship between Empathy, Reliability, Tangibles and Customer Perception towards McDonald's in Kota Bharu, Kelantan.

---

**Keywords: Service quality, Customer Perception, Tangible, Reliability, Empathy**

---

## INTRODUCTION

The issue, at hand is one of service quality in the fast food restaurant hospitality industry. The restaurant cleanliness had a major role in the decision to choose that establishment, followed by the attitudes of the staff and the calibre of the food on the menu. The issues, it seems that the atmosphere of McDonald's restaurants prevents client dissatisfaction. The expectancy-disconfirmation model states that a customer's perceptions are a function of their views. They consider customer perceptions to be transactional, meaning that customers are content with a single aspect of service, as opposed to perceived service quality, which is a general evaluation of a service. The customers won't be satisfied, or won't be as satisfied as they would have been, if the company's service quality expectations are higher than what it really provides if expectations had been met. This study aims to look at how customers perceive a restaurant's level of customer service. Then, a conceptual framework and hypothesis will be used to better explain the link between the independent and dependent variables. The summary will wrap up the discussion. The methodologies and procedures used to assess customer perception and service quality at a

McDonald's restaurant are described and examined in this study. The demographic, sample size, sampling technique, data collecting, research instruments, and data analysis for this study were all described. Therefore, the reliability test will be finished using the Cronbach's alpha approach. More research and analysis into the correlation between the variables will be done using Pearson's correlation test.

1. To determine the relationship between empathy and customer perception at McDonald's Kota Bharu.
2. To determine the relationship between reliability and customer perception at McDonald's Kota Bharu
3. To determine the relationship between tangible customer perception at McDonald's Kota Bharu.

## **SIGNIFICANCE OF THE STUDY**

This study looked into how customers in Kota Bharu, Kelantan, perceived the quality of the service at McDonald's restaurants. This study also offers fresh information and sources for future studies on Malaysian consumers' perceptions of fast food restaurant services. For instance, in Malaysia, an organization's performance and profitability are built on the foundations of service quality and client perceptions. This research also calls attention to the McDonald's restaurant's flaws and offers suggestions to assist them fix them. The results from this study will be useful to the authorities since they need to be concerned about service quality if they want to draw in and keep clients. As a consequence of this study, the McDonald's restaurant will have a more thorough understanding of its customers' demands. Restaurants operating in a market with intense competition can enhance a variety of factors, including the fairness of service quality, service empathy, service tangibility, and service dependability, by using appropriate measures for the situation. The results of this study will help restaurant operators understand how customer perception, which in turn determines their behavioural intentions, is influenced by restaurant service quality.

## **LITERATURE REVIEW**

### **Empathy**

Empathy defined as caring, personalized attentions towards customers (Kassie, 2017). The concept of empathy is commonly heard but often misunderstood. This empathy is usually misunderstood by a few people because the word empathy for some of them is commonly used in terms of feeling, namely pity, sympathy, identification, and self-transfer (Carol M Davis, 1990). Empathy is about knowledge based on the customer's name, preferences, and needs, and thus was born the empathy shown in the above way (Kassie, 2017). According to Kassie (2017), to deliver a service of advantage this small and large business is personal in terms of service. Customer service requires empathy because it bridges knowledge gaps and improves interactions between businesses and their clients. Empathy is a great asset while socialising with other people. If customers feel heard

and appreciated, they are more likely to be satisfied with the responses given to them. Customers may have confidence in the company and understand that these issues will be addressed delicately and rationally.

### **Reliability**

Reliability demonstrates the ability of the service provider to provide services in a dependable and accurate manner. In restaurants, reliability is defined as delivering service as promised, delivering meals on time, and charging fair prices for food. It has been observed that dependability is a very important attribute to possess, especially in the fast food industry. Reliability has to do with how a service provider handles a customer's issue, providing the correct service as requested and at the scheduled time. According to Parasuraman et al. (1985), reliability indicates that businesses provide services accurately the first time. Additionally, it demonstrates how firms try to keep their word and focus on the outcomes.

### **Tangible**

The physical characteristics of the services being offered, such as the way a facility looks, how clean the facilities are, and how the staff members look, are known as tangibles. The term "tangibles" refers to the actual physical characteristics of buildings, machinery, people, and written materials. It includes the menu's appearance and design, as well as restaurant signs and marketing, as well as the condition of the cutlery, crockery, and staff attire (Kassie, 2017). Companies communicate visual and signal quality through tangibles. According to (Kassie 2017), amenities like a well-stocked welcome desk or knowledgeable staff might affect customers' perceptions of the tangible service quality.

### **Customer Perception**

Customer perception refers to the thoughts, emotions, and assumptions that consumers have about your brand. Here's how you create, enhance, and exert control over it. (Inabo, S. 2021). It is crucial for increasing client retention and loyalty as well as brand recognition and reputation. Customers form opinions about products based on what people know in commercials, promotion, user reviews, social media comments, and some other more. Customer perception refers to the thoughts, emotions, and assumptions that consumers have had about the brand. It is crucial for fostering customer retention and loyalty while also increasing brand recognition and reputation. (Parasuraman et. Al 1985)

### **Research Hypothesis**

The literature review made clear that independent factors like Empathy, Reliability, and Tangible have an impact on how customers perceptions. The study's hypotheses were outlined as follows in light of the literature review:

**H1:** There is a positive relationship between empathy and customer perception at McDonald Kota Bharu.

**H2:** There is a positive relationship between reliability and customer perception at McDonald Kota Bharu.

**H3:** There is a positive relationship between tangible and customer perception of McDonald Kota Bharu.

### Research Framework

The Figure 1 below shows the research framework use for this study

Source: Parasuraman et al., (1985)

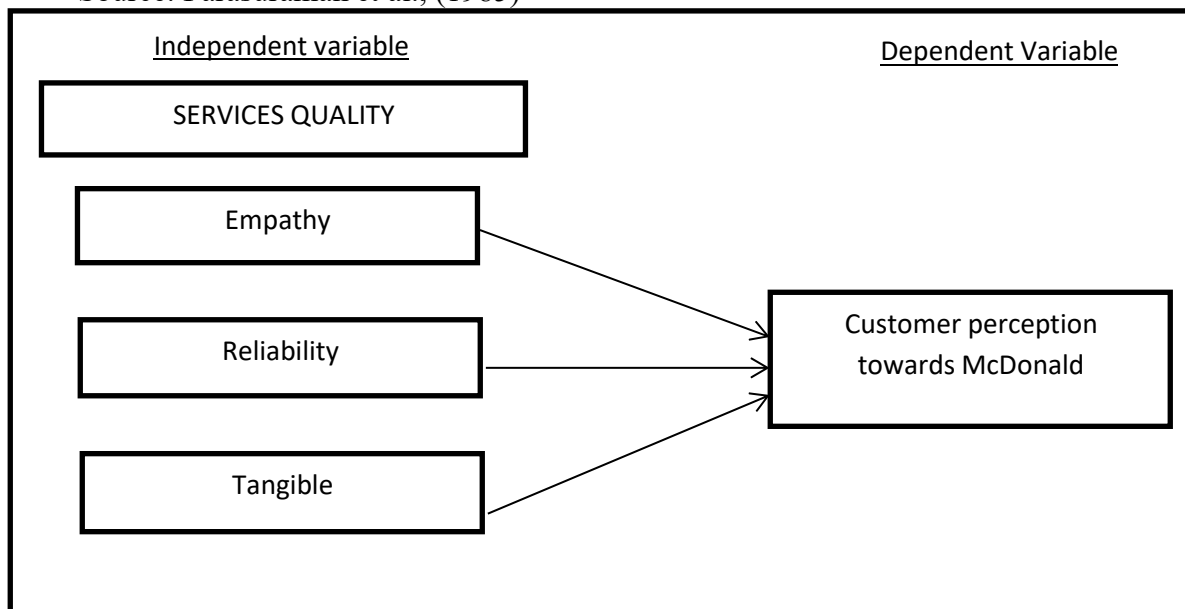

Figure 1: Research Framework

## METHODOLOGY

### Research Design

For this study's quantitative approach, 384 respondents who were dining at the McDonald's restaurant were given questionnaires. Malaysian citizens in Kota Bharu, Kelantan were the target populations in this study.

In addition, the population was given a set of questionnaires to complete in order to gather information about people who have dined in at a McDonald's restaurant. The questionnaire was separated into Sections A, B, and C by the researcher. The questionnaire's Section A asked for general information about the household demographics of Malaysian citizens, including the respondent's gender, age, race, level of education, occupation, and marital status. The questions in Sections B and C went into further detail on the survey's dependent and independent variables, which were (i) Empathy, (ii) Reliability and (iii) Tangible, Multiple-choice questions and 5-point Likert scales of agreement were employed in the design of this questionnaire.



## **Data Collection**

Collecting data, analysing it, and combining it with data from other sources to generate a comprehensive and accurate picture of a subject. A person or organisation may estimate future probabilities and trends and evaluate results with the use of data collecting. To gather information for this inquiry, an online questionnaire will be used. The complete poll will be disseminated via social media sites including Facebook, Instagram, WhatsApp, and Google Forms. The ability to save costs and save time was incredibly convenient.

Convenience sampling, a non-probability sampling technique, was utilised in this investigation. This approach was adopted in the study since the questionnaires were created and disseminated online. Through internet and social media, the questionnaire was made available to the respondents in the Kota Bharu region of Kelantan.

## **Data Analysis**

Computers made data collection easier for the researchers and made quantitative analysis simpler. Frequency analysis, descriptive analysis, reliability testing, and Pearson correlation analysis were the four methods of data analysis employed in this study. SPSS version 27 was used to evaluate the data that was acquired.

## FINDINGS

### Result of Frequency Analysis

Table 1: Frequency Analysis

Demographic	Frequency	Percentage
<b>Gender</b>		
Female	222	57.8
Male	162	42.2
<b>Race</b>		
Malay	162	42.2
Indian	118	30.7
Chinese	68	17.7
Others	36	9.4
<b>Age</b>		
Less than 20 years old	37	9.7
21 - 30 years old	191	49.7
31 - 40 years old	86	22.4
41 - 50 years old	38	9.9
51 years old above	32	8.3
<b>Marital Status</b>		
single	211	54.9
Married	173	45.1
<b>Education Level</b>		
Primary	2	0.5
Secondary	82	21.4
Diploma	80	20.8
Bachelor of Degree	163	42.4
Master	41	10.7
Doctor of philosophy	16	4.2
<b>Occupation</b>		
Student	143	37.2
Employed	185	48.2
Unemployed	26	6.8
Retired	30	7.8
<b>Have you ever dined in at the McDonald's restaurant</b>		
Yes	384	100.0
<b>How often do you eat McDonald's on a monthly basic?</b>		
1-2 times	131	34.1
3-4 times	169	44
5-6 times	42	10.9
7 times or more	42	10.9
Never	0	0
<b>What time do you prefer to dine in at McDonald's</b>		
Breakfast	44	11.5
Lunch	135	35.2
Dinner	175	45.6
Supper	30	7.8
<b>Why do you choose to dine in McDonald's</b>		
Fast service	125	32.6
Good ambience	43	11.2
Good quality as in visual materials	44	11.5
Reasonable Price	34	8.9
Tastes Good	113	29.4
Others	25	6.5



A total of 384 questionnaire sets were assigned through the online platform. This portion contained the respondents' contextual profiles. This section focuses on the respondents' demographic characteristics, including gender, race, age, marital status, level of education, employment, and whether they have ever eaten at a McDonald's restaurant. The profile of the respondent's demographic summary is shown in Table 1. Male respondents make up 162 of the total, while female respondents make up 222. Among the 384 responders, men made up 42.2% of the sample while women made up 57.8%. The statistics from the race, which received 162 replies, reveals that Malaysians (42.2%) make up the bulk of the participants. Indians received 118 responses, or around 30.7% of all responses, to place second. The Chinese were next, with 68 replies 17.7% representing 9.4 per cent of the total, and one respondent representing 36 replies of the total from other races.

As shown by table 1, the data revealed that the majority of those who answered to the questionnaire were between the ages of 21-30 years old, with 191 people answering and a response rate of 49.7%. Then came the 31-40 age group, which had 86 responders and a 22.4% response rate. Age group of 41-50 years old had 38 respondents answer response rate of 9.9%. Then, 37 people in the less than 20 years old age group answered to the survey, 9.7% of all respondents. Finally, 51 years old above is 32 and 8.3%.

According to the table, the total number of married respondents is 173, while the total number of single respondents is 211. Married respondents made up 45.1% of the total 384 respondents, while single respondents made up 54.9%.

In educational level, The primary level, is 2 with 0.5%, the most respondents are from the Bachelor of degree, with 163 respondents and a value of 42.4%. Respondents from the secondary education level came in second with 82 respondents and a value of 21.4%, followed by respondents from the postgraduate with 41 respondents and a value of 10.7%. Diploma with 80 and 20.8% finally, the doctor of philosophy with 16 people responding for a total of 4.2%.

According to the table, student respondents percentage of respondents (37.2%) with 143 respondents. Employed came in largest with 185 replies, accounting about 48.2% of the total. The Unemployed were next, with 26 replies representing 6.8% of the total.

Furthermore, all 384 respondents were had dine in at the McDonald's restaurant with 100 percent. How often do you eat mcdonald's on a monthly basic, 1-2 times is 131 with 34.1, Then, the largest is 169 with 44% percent. Moreover, 5-6 times is 42 and with the percent 10.9%. Next, 7 times or more is 42 with 10.9 and finally, never is 0 respondent.

## Result of Descriptive Analysis

Table 2 : Descriptive Analysis

Variable	Item	Mean score	Standard Deviation
Empathy	- McDonalds gives you individual attention	4.0052	83960
	- McDonald's has operating hours convenient to all its customer	4.3594	78897
	- Best customer service offered at McDonald's restaurant?	4.1458	79133

	- McDonald's has the best interest of the customers	4.21	724
	- The employees of MacDonal'd's understand your specific needs	4.2292	70402
Reliability	- McDonald's promises to do something by a certain time, and it does so	4.1901	77345
	- McDonald's shows a sincere interest in solving it, when you have a problem	4.1693	74399
	- McDonald's performs the right service	4.2630	70883
	- McDonald's provides its service at the time it promises to do so	4.2109	72247
Tangible	- McDonald's has modern-looking equipment	4.3594	67093
	- McDonald's physical facilities are visually appealing	4.2995	68280
	- McDonald's reception desk employees are neat appearing	4.3099	67426
	- Materials associated with the service (such as pamphlets or statement) are visually appealing at McDonald's	4.2865	65135
Customer Perception	- I will recommend the McDonald's restaurant to other people	4.1875	74487
	- I will recommend others about the McDonald's restaurant experiences	4.1667	76703
	- Overall, I am satisfied with my experience in McDonald's restaurant	4.2995	64342
	- I am satisfied with the service provided by the McDonald's restaurant.	4.3359	62511
	- I am quite pleased with employees/ability of restaurants to clearly and thoroughly answer all of my inquires	4.2891	70232

The mean score for all dimensional variables was moderate, with Empathy at 4.1875 (SD = 0.74487), reliability at 4.1667 (SD = 0.76703), and tangible at 4.2995 (SD = 0.64342). Furthermore, the dependent variable verified the middle mean score (M = 4.3359, SD = 0.62511), with customer satisfaction.

In this variable, the number of items is as follow: Empathy (5), Reliability (4), Tangible (4), and customer perception (5).

Conducted in this analysis to determine Cronbach's Alpha values for all variables. The values are as follows Empathy (0.876), reliability(0.903), tangible (0.857), and customer perception (0.920).

## Result of Pearson Correlation Analysis

The Table 5 below shows the Pearson Correlation Analysis

Table 4: Pearson Correlation Analysis

Hypothesis	Result	Finding of data analysis
H1- There is a significant relationship between Empathy and customer perception	$r = 0.543, p = 0.001$ Moderate positive	H1 - Accepted
H2- There is significant relationship between Reliability and customer perception	$r = 0.544, p = 0.001$ moderate positive	H2 - Accepted
H3- There is significant relationship between Tangible and customer perception	$r = 0.621, p = 0.001$ moderate positive	H3 - Accepted

Hypothesis 1 (H1) proposed that Empathy is a moderate positive relationship with customer perception. The finding reported in this study revealed that the empathy recorded value of Pearson Correlation, which is  $r = 0.543, p = 0.001$ . Thus, the result accepts hypothesis 1 (H1), whereby empathy is moderate positively significant with customer perception.

Hypothesis 2 (H2) proposed that reliability is a moderate positive relationship with customer perception. The finding reported in this study revealed that the reliability recorded value of Pearson Correlation, which is  $r = 0.544, p = 0.001$ . Thus, the result accepts hypothesis 2 (H2), whereby reliability is moderate positively significant with customer perception.

Hypothesis 3 (H3) proposed that tangible is a moderate positive relationship with customer perception. The finding reported in this study revealed that the tangible recorded value of Pearson Correlation, which is  $r = 0.621, p = 0.001$ . Thus, the result accepts hypothesis 3 (H3), whereby tangible is moderate positively significant with customer perception.

## DISCUSSION AND RECOMMENDATION

The discussion aims to answer the queries and address the hypotheses raised in the study's first chapter. This study has looked at the association between customer perception of McDonald's restaurant and service quality in general. The current study would offer various recommendations for SERVQUAL (service quality) based on the study's findings in order to enhance all of the service quality characteristics and raise perceived service quality and customer perceptions.

Determining the link between tangibles and customer satisfaction with McDonald's in Kota Bharu is the third research objective. The data analysis findings in Chapter 4 demonstrate a favourable relationship between tangibility and customer satisfaction. The results of the correlation between the independent and dependent variables show that the H3 is reflected. The

majority of respondents concur that customer satisfaction can be influenced by how tangible a service's quality is.

The results of quantitative research are typically limited, which is the study's second problem. This is essentially the researcher's preferences mostly determine the outcomes. This constrained outcome can be ascribed to the systematic design of the surveys. Frequently, respondents to surveys are provided with little or no chance to explain their answers. As a result, answers can only address the question that was asked. Only three independent variables—service quality, empathy, dependability, and tangibles—are examined in this study. Customer perception is one of the dependent variables as well. Similar to the food and retail industries, there are a number of factors that have an effect on or interact with how people perceive a product or service. There are other crucial aspects of this study as well. This was caused by a dearth of resources and recommendations that would have allowed researchers to base their conclusions on other factors.

Additionally, respondents concurred that they liked the ambiance at McDonald's in Kota Bharu. The fast-food restaurant not only offers high-quality goods for sale, but it has also been set up and designed in keeping with the setting and theme. The supply of a favourable environment is one of the parts for the target company. As customers are drawn to an atmosphere or environment, it might be advantageous to have a positive atmosphere by producing an effective service.

## **CONCLUSION**

In the conclusion of this chapter, the researchers must discuss the study's objectives in relation to the topic being investigated. In McDonald's in Kota Bharu, this study examines the connections between Empathy, reliability, tangible, and customer perception. Based on the examined literature, an analysis framework has been developed.

The link between the independent and dependent variables was the subject of the study. 384 participants completed an online survey for this study. Descriptive statistics, reliability analysis, and correlation analysis were used to collect and analyse the data using the SPSS software.. Overall, based on Pearson's correlation analysis, the Empathy scored a value of \*0.543, followed by reliability with \*0.544, and Tangible with \*0.621.

## REFERENCES

- Agbor, J. (2011). *The relationship between customer satisfaction and service quality : a study of three service sectors in Umeå.*
- Akroush, M. N., & Al-Debei, M. M. (2015). An integrated model of factors affecting consumer attitudes towards online shopping. *Business Process Management Journal*, 21(6), 1353–1376. <https://doi.org/10.1108/bpmj-02-2015-0022>
- Akter, M., Sadekin, M. N., & Patwary, A. K. (2020). An Empirical Study on Students' Satisfaction from Mawlana Bhashani Science & Technology University, Bangladesh. *Review of Economics and Development Studies*, 6(2), 363-379.
- Al Mahmud, S. R. (2020). The effectiveness of Facebook advertisements on purchase intention of customers in Malaysia. *South Asian Journal of Social Sciences and Humanities*, 1(1), 97-104.
- Alom, S., Patwary, A. K., & Khan, M. M. H. (2019). Factors affecting the turnover intention of Bangladeshi migrants in the United Arab Emirates: An empirical study on the hotel industry. *International Journal of Innovation, Creativity and Change*, 8(3), 344-360.
- Alsayed, N., Suifan, T., & Alawneh, A. (2015). Exploring the effect of perceived service quality on customers satisfaction: A study of banking sector in Jordan. *Journal of Management Research*, 7, 122. <https://doi.org/10.5296/jmr.v7i1.6966>
- Asiamah, N., Mensah, H., & Fosu Oteng-Abayie, E. (2017). *The Qualitative Report General, Target, and Accessible Population: Demystifying the Concepts for Effective Sampling.* <https://nsuworks.nova.edu/cgi/viewcontent.cgi?article=2674&context=tqr>
- Fengmin, Z., Baijun, W., Jiangtao, B., Li, L., & Patwary, A. K. (2022). Investigating revisit intention of medical tourists in China through nutritional knowledge, perceived medical quality, and trust in the physiologist: A recommendation on health tourism policy measures. *Frontiers in Public Health*, 10, 893497.
- Hau-siu Chow, I., Lau, V. P., Wing-chun Lo, T., Sha, Z., & Yun, H. (2007). Service quality in restaurant operations in China: Decision- and experiential-oriented perspectives. *International Journal of Hospitality Management*, 26(3), 698–710. <https://doi.org/10.1016/j.ijhm.2006.07.001>
- Hazbar, A. M. H., Alem Mohammed, A., & Karim, A. K. A. (2019). An Empirical Study of Factors Influencing hotel customers' online booking Intention. *مجلة العلوم التربوية و الدراسات الإنسانية*, 5(5), 1-17.
- Hilly, Raju, N., Singh, S. S., & Tariyal, M. T. (2015). Service Quality of McDonald's. *Global Journal of Enterprise Information System*, 7(3), 71–79. <https://www.gjeis.com/index.php/GJEIS/article/view/382>
- Li, L., Ragavan, N. A., Patwary, A. K., & Baijun, W. (2022). Measuring patients' satisfaction toward health tourism in Malaysia through hospital environment, nutritional advice, and perceived value: A study on Chinese exchange students. *Frontiers in public health*, 10, 893439.
- Li, L., Wu, B., & Patwary, A. K. (2022). How marine tourism promote financial development in sustainable economy: new evidences from South Asia and implications to future tourism students. *Environmental Science and Pollution Research*, 29, 1155-1172.
- Li, L., Wu, B., & Patwary, A. K. (2022). The psychosocial factors affecting Chinese Outbound Exchange and mobility students' academic performance during COVID-19. *Frontiers in psychology*, 13, 872516.
- Parasuraman, A., Zeithaml, V. A., & Berry, L. L. (1985). A Conceptual Model of Service



- Quality and Its Implications for Future Research. *Journal of Marketing*, 49(4), 41–50. <https://doi.org/10.2307/1251430>
- Patwary, A. K., Roy, B., Hoque, R., & Khandakar, M. S. A. (2019). Process of developing a community based tourism and identifying its economic and social impacts: An Empirical study on Cox's Bazar, Bangladesh. *Pakistan Journal of Humanities and Social Sciences*, 7(1), 1-13.
- Sumethokula, P., Patwary, A. K., Srinuanpanc, B., Srinuanpand, C., Suwandee, P., Thammathikulf, A., & Phanong, W. (2020). The potential of new tour repackaging for creative tourism among entrepreneurs in Nakhon Si Thammarat. *International Journal of Innovation, Creativity and Change*, 13(10), 1752-1771.
- Theories and Concepts of the SERVQUAL Model*. (2021, November 1). Ukdiss.com. <https://ukdiss.com/examples/origins-of-servqual-model.php?vref=1>
- Wong, A., & Sohal, A. (2003). Service quality and customer loyalty perspectives on two levels of retail relationships. *Journal of Services Marketing*, 17(5), 495–513. <https://doi.org/10.1108/08876040310486285>
- Wu, B., Liu, S., Wang, J., Tahir, S., & Patwary, A. K. (2021). Assessing the mechanism of energy efficiency and energy poverty alleviation based on environmental regulation policy measures. *Environmental Science and Pollution Research*, 28, 40858-40870.
- Wu, B., Zhai, B., Mu, H., Peng, X., Wang, C., & Patwary, A. K. (2021). Evaluating an economic application of renewable generated hydrogen: A way forward for green economic performance and policy measures. *Environmental Science and Pollution Research*, 1-15.
- Yunus, N. K. Y., Zulkeflee, M., Razak, A., & Ilias, A. (2013). *Expectation towards McDonald's Malaysia: A Study on Service Quality*. Papers.ssrn.com. <https://ssrn.com/abstract=2306212>

# ***The Factors That Affect Customer Satisfaction in Hotels at Kota Bharu, Kelantan***

**Mohd Sobri Bin Mohammed Ali, Muhammad Hazim Bin Hamisan, Hamisan Bin Mufti, Kommathi Chandran, \*Nor Amira Binti Mohd Razali**

Faculty of Hospitality, Tourism and Wellness University Malaysia Kelantan  
Corresponding email : [noramira.mr@umk.edu.my](mailto:noramira.mr@umk.edu.my)

---

## **ABSTRACT**

*With the increasing competitiveness in the hospitality sector, hoteliers face the challenge of differentiating their products and services. The primary objective of this study is to investigate the factors that influence guest satisfaction in the hotel industry, focusing on hotels in Kota Bharu, Kelantan. A quantitative research approach was employed, utilizing a questionnaire as the data collection instrument. The study collected data from 384 respondents via an online platform and analyzed using statistical techniques to determine the relationship between service quality dimensions (tangibles, reliability, and responsiveness) and customer satisfaction. The analysis revealed significant associations between tangibles, reliability, and responsiveness with customer satisfaction in hotels in Kota Bharu, Kelantan. These findings contribute to theoretical and practical perspectives by comprehensively understanding the factors that impact guest satisfaction in the local hotel industry and hence enabling the hoteliers to develop effective strategies to enhance service quality and improve overall customer satisfaction.*

Keywords: Hospitality, Service Quality, Guest Satisfaction, Tangible, Reliability, Responsiveness

---

## **INTRODUCTION**

As a diverse sector encompassing lodging, food and drink service, event planning, theme parks, and travel and tourism, hospitality management places great importance on customer satisfaction to deliver exceptional experiences. In an increasingly competitive environment, businesses and organizations in the industry strive to maintain customer loyalty and improve the quality of their goods and services. Various indicators have been developed and applied internationally to evaluate customer satisfaction over the past three decades. Clarity, tangibility, and empathy are crucial components for achieving successful customer satisfaction (Markovi, 2010), especially when assessing service quality in hotel settings.

Additionally, service responsiveness, transaction accuracy, and security features have gained recognition as factors influencing customers' service quality evaluations. Prior research has emphasized the significance of the five service quality attributes concerning customer satisfaction, emphasizing the provision of consistently high-quality services as the key to ensuring customer delight (Khan & Fash, 2014; Prahalad & Ramaswamy, 2004; Oluwafemi & Dastance, 2016). Nevertheless, more research must be conducted to establish a causal relationship between customer satisfaction and service excellence, necessitating further investigation into how service quality dimensions impact customer happiness.

While previous studies have identified a positive correlation between customer satisfaction and service quality, they have yet to thoroughly examine the specific connections between each aspect of service quality and customer satisfaction. Therefore, it is essential to investigate and define these relationships comprehensively. Furthermore, previous research has provided only a general overview of the relationships between service quality and dimensional parameters, needing more in-depth explanations of each factor's relationship with service quality.

In the context of hotels in Kota Bharu, customers have expressed concerns regarding cleanliness and tidiness despite positive overall ratings and reviews. This study aims to investigate the impact of service quality on customer satisfaction in Malaysia by examining the relationship between service quality dimensions (tangibles, reliability, and responsiveness) and customer satisfaction. By identifying and analyzing these relationships, this research aims to contribute to the body of knowledge in the field and provide insights for hotels in Kota Bharu to enhance service quality and improve customer satisfaction. The specific objectives for this study are as follow:

1. To examine the relationship between tangible with customer satisfaction in hotel.
2. To determine the relationship between reliability with customer satisfaction in hotel.
3. To identify the relationship between the responsiveness with customer satisfaction in hotel.

This empirical study makes a valuable contribution to the existing body of knowledge on customer satisfaction in the hotel industry. By investigating the factors influencing consumer satisfaction within the hotel sector, this research offers insightful findings that can inform and guide hoteliers in meeting customer expectations. Additionally, the study provides consumers with valuable information that can assist them in making informed decisions when choosing hotels.

## **LITERATURE REVIEW**

In this chapter, the researchers briefly describe the literature review, hypothesis, conceptual framework and summary. This chapter will discuss the influenced satisfaction in hotel service quality in Kota Bharu, Kelantan. Tangible, reliability and responsiveness are independent variables while customer satisfaction is dependent variable. Based on the literature review that was discussed and the research problem, the analysis's hypothesis was presented in the manner that follows.

### **Tangible**

Tangibles encompass various elements, such as the physical environment, personnel, and communication materials within a service context. These tangible components can create an impression or perception on customers without requiring monetary transactions (Asubonteng et al., 1996). Assessing perceived quality involves comparing customers' expectations with their actual experiences, as service quality is determined by the disparity between these two factors (Naik et al., 2010; Yesilada & Direktor, 2010).

Measuring perceived quality is essential as it comprehensively evaluates how well a service aligns with customer expectations. Businesses that meet or surpass customer expectations are considered to possess a high level of service quality. Furthermore, service quality directly impacts customer loyalty, as satisfied customers are more likely to remain loyal, attract new customers through positive word-of-mouth referrals, enhance the establishment's image, and ultimately increase profitability within the hotel industry.

## **Reliability**

Reliability, as defined by Drost (2011), refers to the extent to which measurements exhibit reproducibility when performed by different individuals on separate occasions, under varying conditions, and using different tools to measure the intended construct or skill. It represents the consistency and dependability of measurement. For instance, when different individuals estimate a person's weight, the values obtained may not precisely match the actual weight, indicating an unreliable measurement. However, if multiple individuals use the same weighing scale to measure the weight, there is a higher likelihood of obtaining consistent results, thus enhancing the measurement's credibility. Bajpai and Bajpai (2019) also emphasize the importance of reliability and validity as two psychometric properties in measurement.

In the context of hotel service quality, service providers must have efficient means of tailoring their services to meet customers' specific requirements to some extent. This strategy often involves the development of computerized customer information systems that enable service providers to capture guest preferences and provide personalized and enhanced services. For example, in a hotel in Kota Bharu, Kelantan, an information system could be implemented to record and utilize guest preferences, allowing for the pre-assignment of preferred room types and stocking the room with requested whiskey brands from previous visits. As mentioned earlier, reliability refers to the stability of measurements across different scenarios where consistent results should be produced (Nunnally, 1978). It represents the ability to replicate or reproduce study findings. When a researcher conducts a study under specific conditions and obtains consistent results upon repeating the study, the data is considered reliable. Drost (2011) highlights that random and systematic errors can affect the trustworthiness of data derived from research instruments. Random error can be attributed to unknown and uncontrollable external factors that randomly influence specific observations but not others. For example, respondents in better moods may react more favorably to concepts such as self-esteem, contentment, and satisfaction than those in worse moods.

## **Responsiveness**

Responsiveness, as related to the core tenets of general systems theory, pertains to a system event caused by another event occurring within the same system or its environment. Ackoff (1971) describes such an event, produced by another system or environmental stimulus, as a "response." Hence, a response is an event that the system contributes to causing. In hotel management, the perceived value is significant in achieving customer satisfaction. Moliner highlights that perceived value encompasses functional value (quality and price of a product or service), emotional value (associated with feelings), and social value (resulting from personal experiences and alternative options). Anderson et al. define value in business markets as "the perceived worth in monetary terms of the economic, technical, service, and social benefits received by a customer firm in exchange for the price paid, considering the offerings and prices of available suppliers." They consider economic, technical, service, and social benefits as integral components of value, in addition to price and the offerings and prices of suppliers.

Moreover, Gale et al. assert that customer value is "market-perceived quality adjusted for the relative price of the seller's goods." Monroe defines consumer perceptions of value as a trade-off between the perceived quality or benefits of goods and the sacrifice perceived in paying the price. These definitions align with the notion that value is a proportion between the price (monetary

and non-monetary) paid and the perceived quality attained by the customer, as stated by Gale et al. and Rust et al.

Perceived quality, customer expectations, and perceived value form the three primary pillars of customer value. Achieving a significant advancement in all three dimensions provides creative or breakthrough customer value. King highlights the unique connection between service providers and clients in the context of hospitality as a commercial activity. In this connection, the host attends to the needs and desires of guests, ensuring their satisfaction and a feeling of being at home. Satisfactory service quality is indispensable for the success of the hospitality business. Similar effects of service quality have been reported in the tourism, hospitality, and leisure industries, including enhancing guest convenience, improving the service provider's image, ensuring customer security, generating profitable traffic, cost savings, increasing market share, and establishing a competitive advantage and customer demand properties. The measurement scales used to assess these effects are crucial for determining the adequacy and accuracy of scientific research techniques when investigating the impact of hotel service quality on customer satisfaction at Hotel Kota Bharu, Kelantan.

### **Customer Satisfaction**

The topic of total satisfaction has become a subject of extensive debate among researchers. Advocates of this concept often highlight the significance of meeting specifications, complying with regulations, and delivering high-quality services to customers (Anwar & Abd Zebari, 2015). In the present context, consumer happiness is of paramount importance. Customers are likely to utilize the service again or recommend it to others if they are satisfied. If a guest leaves a hotel unsatisfied, all the efforts invested in improving service quality would be in vain. Meeting consumer expectations remains a pressing challenge in the industry today (Anwar & Surarchith, 2015).

The focus of the hospitality business extends beyond the customer to encompass a small fraction of the actual consumption process, often accompanied by preconceived expectations of service and quality. Contemporary consumers in the hospitality industry are increasingly time-constrained, sophisticated, and demanding (Anwar, 2017). Understanding the customer base and the level of satisfaction they anticipate is crucial before implementing management strategies to enhance service quality. Anwar (2016) defines satisfaction as "an individual's experience of joy or disappointment resulting from comparing the perceived performance or outcome of a product to their expectations."

### **Research Hypothesis**

F The literature review highlighted that independent variables such as tangible, reliability, and responsiveness are the factors that affect customer satisfaction in hotels at Kota Bharu, Kelantan. The hypothesis in the study is to find out whether there are any correlations or relationship between dependent variables and independent variables as follow:

H1: There is a relationship between tangible and customer satisfaction in hotel at Kota Bahru, Kelantan

H2: There is a relationship between realibility and customer satisfaction in hotel at Kota Bahru, Kelantan

H3 : There is a relationship between responsiveness and customer satisfaction in hotel at Kota Bharu, Kelantan

### Research Framework

Figure 1 below shows the research framework used for this study.

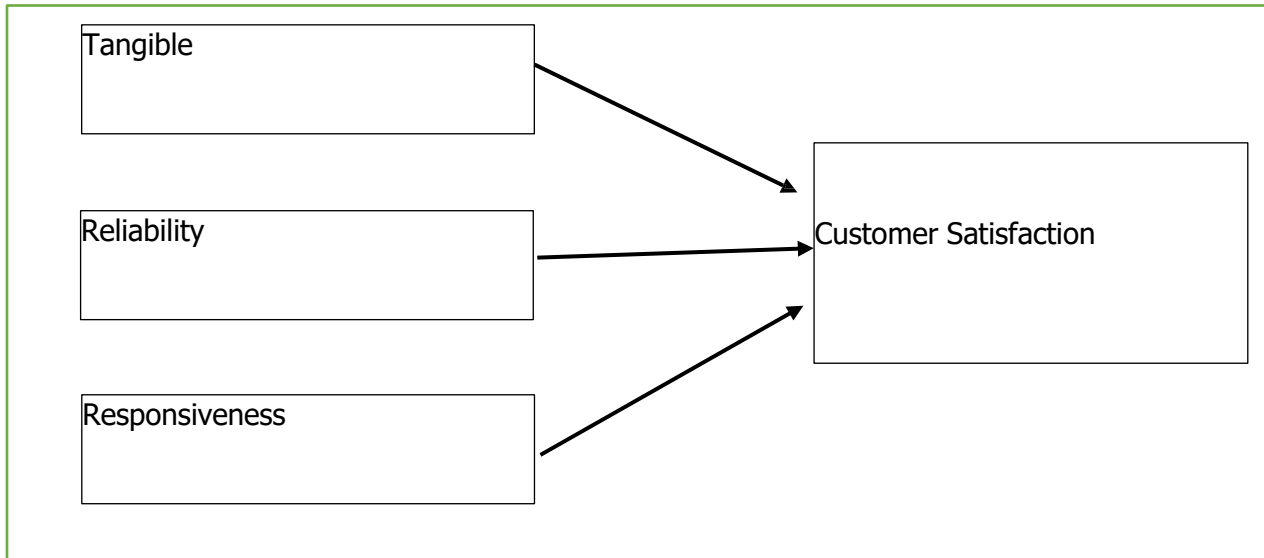

Figure 1: Conceptual Framework

## METHODOLOGY

### Research Design

A research design plays a crucial role in organizing the methodology and processes of a study. To ensure the success of the research, it is essential for researchers to diligently execute their study and employ an established testing strategy. In the present study, the researchers collected data through the utilization of a questionnaire and employed a quantitative approach.

### Data Collection

This research employed a survey method with questionnaires as the primary data collection tool. The questionnaires were administered using Google Form and distributed to respondents through popular social media platforms like WhatsApp and Telegram. The survey was conducted online to ensure convenience for the participants. The questionnaire was designed to gather data on independent variables such as tangible aspects, reliability, and responsiveness in relation to customer satisfaction in hotels located in Kota Bharu, Kelantan.

### Sampling

In this study, the sampling method employed is non-probability sampling, specifically convenience sampling. Convenience sampling was utilized to gather information from respondents for the purposes of the research. The researcher aimed to investigate perspectives from a broad range of individuals, objects, or entities within the target population. According to Etikan, Musa,

and Alkassim (2016), convenience sampling involves selecting respondents who are readily available and willing to participate. Kumar et al. (2013) defines convenience sampling as the practice of gathering data from respondents who can easily be accessed and are suitable for the researcher's needs.

### **Data Analysis**

Data analysis involves the systematic examination, cleansing, manipulation, and modeling of data to extract crucial information, facilitate decision-making, and offer recommendations (Pal, 2017). In the present study, the researchers utilized the SPSS software version 26.0 for conducting statistical data analysis. The survey data collected from the respondents were compiled and analyzed using the Statistical Package for Social Sciences (SPSS). SPSS is a software program that provides a user-friendly interface for data entry and analysis, allowing the construction of tables and pie charts. The analysis techniques employed in this study included frequency analysis, descriptive analysis, reliability analysis, and correlation analysis.

## **FINDINGS**

### **Demographic Analysis**

Table 1 below shows the results of frequency analysis

Table 1: Frequency Analysis

Characteristics	Frequency	Percentage
<b>Gender</b>		
Male	213	55.5
Female	171	44.5
<b>Age</b>		
20-25	130	35.5
26-30	120	25.5
31-35	60	18.0
35-40	60	18.0
40 and above	14	3.0
<b>Occupation</b>		
Government Sector	30	15.2
Private Sector	20	12.0
Unemployed	85	22.1
Self-Employed	25	13.9
Student	224	36.8
<b>Income</b>		
Below RM 1000	92	24
RM 1001- RM 2000	161	41.9
RM 2001-RM 3000	73	19.0
RM 4001 above	58	15.1

Marital Status		
Married	94	31.5
Single	290	68.5

Table 1 presents the results of the frequency analysis conducted on the gender, age, occupation, income, and marital status of the 384 respondents. The table indicates that male respondents accounted for 55.5% (n=213) of the sample, while female respondents comprised 44.5% (n=171). Among the different age groups, the highest number of respondents fell within the 20-25 years age bracket, constituting 35.5% (n=130) of the sample. The second highest number of respondents, 25.5% (n=120), belonged to the 26-30 years age group. The age groups 31-35 years and 35-40 years each had 18.0% (n=60) of the respondents, while the age group 40 and above accounted for 3.0% (n=14) of the sample.

Regarding occupation, respondents from the government sector represented 15.2% (n=30) of the sample, while those from the private sector comprised 12.0% (n=20). Unemployed respondents constituted 22.1% (n=85), and self-employed respondents accounted for 13.9% (n=25). Students made up the largest group with a total of 224 respondents, representing 36.8% of the sample.

In terms of income, respondents with an income below RM 1000 numbered 92 (24.0%), while those with an income ranging from RM 1001 to RM 2000 constituted 41.9% (n=161) of the sample. Respondents with an income between RM 2001 and RM 3000 represented 19.0% (n=73), and those with an income of RM 4001 and above totaled 58 (15.1%). Marital status included two categories: married and single. The total number of married respondents was 94 (31.5%), whereas the majority of respondents, 290 (68.5%), were single.

### Descriptive Analysis

Table 2 below shows the results of descriptive analysis.

Variable	Item	Mean Score	Standard deviation
Tangible	The hotel provides clean and comfortable rooms	3.5885	1.37773
	The hotel has swimming pool, sauna and health club	3.5781	1.38215
	The hotel has appealing decorations	3.5521	1.34704
	The hotel has neat appearance staff	3.6380	1.35065
	The hotel has courteous and polite to the customers	3.5651	1.37715
Reliability	Staff at the hotel are able to provide service as promised	3.8620	1.36889
	Staff of the hotel are dependable in handling customers service problem	3.7943	1.37940



	The hotel keeps customers informed of the performance of services	3.7917	1.39126
	Staff of the hotel keeps confidential records of customers	3.8021	1.39091
	Staff of hotel is friendly and helpful for customer	3.7214	1.36076
Responsiveness	Staff at the hotel are ready to responds to customer request	3.94	0.859
	Staff at the hotel are always willing to help customers	3.86	0.929
	Staff at the hotel has some knowledge to provide to the guest	2.66	1.201
	Staff at the hotel has flexibility according to guests demand	2.74	1.133
Customer Satisfaction	I feel satisfied with the service of this hotel	3.8646	1.31962
	I feel I get more attention from the employees of this hotel	3.6250	1.38058
	Hotels ensure the safety of their customers by appointing guards in 24 hours inspection	3.8646	1.26920
	The guest feels safe and secure in their stay in the hotel	3.8698	1.32410
	Staff of the hotel have customers best interest at heart	3.9062	1.27910

Table 2 presents the mean and standard deviation for the items used to assess the factors of tangible, reliability, and responsiveness that influence customer satisfaction. Each variable was measured using five (5) questions. Regarding the tangible variable, the highest mean of 3.6380 was observed for the statement, "The hotel has appealing decorations." Conversely, the lowest mean of 3.5651 was recorded for the statement, "The hotel has appealing decorations."

For the reliability variable, the highest mean of 3.8620 was found for the statement, "Staff at the hotel are able to provide service as promised." On the other hand, the lowest mean of 3.7214 was obtained for the statement, "Staff of the hotel is friendly and helpful for customers." Regarding responsiveness, the highest mean of 3.7396 was observed for the statement "Staff readiness to respond to customers' inquiries." Conversely, the lowest mean of 3.6276 was recorded for the statement "Staff at the hotel are always willing to help customers." Lastly, the highest mean of 3.9062 was reported for the customer satisfaction variable for the statement, "The staff are courteous and polite to the customers." Conversely, the lowest mean of 3.6250 was obtained for the statement, "I feel I get more attention from the employees of this hotel."

## Reliability Analysis

Table 3 below shows the result of reliability analysis

Table 3: Result of reliability analysis

Variables	Number of Items	Cronbach's Alpha
Tangible	5	0.774
Reliability	5	0.880
Responsiveness	5	0.706
Customer Satisfaction	5	0.709

Based on the findings presented in Table 3, the results of the pilot test for each section of the questionnaire are considered acceptable, as all the values exceed the threshold of 0.700 for Cronbach's Alpha. The questionnaire comprised five questions used to measure the variables in this study. The first independent variable, tangible, demonstrated a Cronbach's Alpha coefficient of 0.774, indicating a good strength of association among the items in this variable. Similarly, the second independent variable, reliability, exhibited a Cronbach's Alpha coefficient of 0.880, indicating a very good strength of association. The variable responsiveness yielded a Cronbach's Alpha coefficient of 0.706, signifying a good strength of association. Lastly, for the dependent variable, e-learning on academic performance, the Cronbach's Alpha coefficient was 0.709, indicating a good strength of association. It is noteworthy that all the variables consisted of valid questions. Overall, the pilot test results confirm the reliability and validity of the questionnaire items used to measure the variables in this study.

## Pearson Correlation Analysis

Table 4 presents the findings of the Pearson Correlation Analysis conducted in this study.

Table 4: Pearson Correlation Analysis

Hypothesis	P-Value	Result (Supported/Not Supported)
<b>H1</b> : There is a relationship between tangible and customer satisfaction in hotel at Kota Bharu, Kelantan	0.516	H1 is supported
<b>H2</b> : There is a relationship between realibility and customer satisfaction in hotel at Kota Bharu, Kelantan	0.54	H2 is supported
<b>H3</b> : There is a relationship between responsiveness and customer satisfaction in hotel at Kota Bharu, Kelantan	0.517	H3 is supported

Based on the results shown in Table 4, the hypothesis testing revealed significant relationships between the variables of tangible, reliability, and responsiveness and their impact on customer satisfaction in hotels at Kota Bharu, Kelantan. Consequently, all the hypotheses were accepted at a 0.01 significance level. These findings provide evidence that there is a statistically significant association between tangible aspects of hotel services, the reliability of hotel services, responsiveness of hotel staff, and customer satisfaction. This suggests that the tangible elements, reliability, and responsiveness play crucial roles in shaping customer satisfaction in hotels at Kota Bharu, Kelantan.

## **DISCUSSION AND RECOMMENDATION**

From the findings, it is evident that there is a strong positive relationship between the tangible factors and customer satisfaction in hotels in Kota Bharu, Kelantan, as indicated by a correlation coefficient of 1. The p-value of 0.516 further confirms the positive relationship, providing support for H1. This finding suggests that customers in Kota Bharu, Kelantan place high importance on the tangible aspects of hotels and derive significant satisfaction from them. This aligns with previous studies conducted by Ali and Gardi (2021), which also identified tangible factors as influential determinants of customer satisfaction in the hotel industry.

Besides that, the analysis revealed a strong positive relationship between responsiveness and the factors influencing customer satisfaction in hotels in Kota Bharu, Kelantan, as indicated by a correlation coefficient of 0.706. The p-value of 0.517 further supports this positive association, providing confirmation for H3. This finding is consistent with the results of a previous study, which also found a positive relationship between responsiveness and customer satisfaction in the hotel industry. Future research should consider incorporating additional independent variables, such as students' attitudes, as these may have an impact on their satisfaction with hotels in Kota Bharu, Kelantan. The current findings suggest that students' attitudes towards customer satisfaction are relevant in this context.

Moreover, it is recommended that future studies employ a quantitative research methodology, as it enables faster data collection compared to qualitative approaches. Quantitative research allows for numerical data, facilitating the use of statistical tests to make meaningful statements about the data. Researchers can benefit from a diverse range of data collection techniques, from unstructured to semi-structured methods. Furthermore, it would be valuable for future studies to explore customer satisfaction in hotels across Malaysia. Such investigations may shed light on potential issues within the hospitality industry and offer insights that surpass the scope of the present study. By expanding the research to a broader context, researchers can generate a more comprehensive understanding of the factors influencing customer satisfaction in hotels, specifically in Kota Bharu, Kelantan.

## CONCLUSION

The aim of this study was to investigate the factors influencing customer satisfaction in hotels located in Kota Bharu, Kelantan. Specifically, the study focused on the variables of tangibility, reliability, and responsiveness. Through the application of Pearson Correlation analysis, the research aimed to establish the relationships between these independent variables and customer satisfaction as the dependent variable.

The findings of the study revealed significant associations between the independent variables (tangibility, reliability, and responsiveness) and the factors influencing customer satisfaction in hotels in Kota Bharu, Kelantan. This suggests that these factors play a crucial role in shaping customer satisfaction within the hotel industry. The results support the notion that tangible aspects, such as appealing decorations, reliable services as promised, and responsive staff, contribute significantly to customer satisfaction in hotel settings.

In conclusion, this study emphasizes the importance of tangibility, reliability, and responsiveness in influencing customer satisfaction in hotels located in Kota Bharu, Kelantan. The findings provide valuable insights for hotel management and practitioners to prioritize and enhance these factors to meet customer expectations and ultimately improve overall satisfaction levels. Further research in this area could explore additional variables and extend the investigation to a wider range of hotels within the Malaysian hospitality industry, contributing to a more comprehensive understanding of customer satisfaction dynamics.

## REFERENCES

- Akter, M., Sadekin, M. N., & Patwary, A. K. (2020). An Empirical Study on Students' Satisfaction from Mawlana Bhashani Science & Technology University, Bangladesh. *Review of Economics and Development Studies*, 6(2), 363-379.
- Alom, S., Patwary, A. K., & Khan, M. M. H. (2019). Factors affecting the turnover intention of Bangladeshi migrants in the United Arab Emirates: An empirical study on the hotel industry. *International Journal of Innovation, Creativity and Change*, 8(3), 344-360.
- Bhargava, V. (N.D.), 'Service Quality', *Business Management Ideas* [Online]. Available at: [https://www.researchgate.net/publication/356592279\\_Service\\_Quality\\_And\\_Its\\_Impact\\_On\\_Customer\\_Satisfaction](https://www.researchgate.net/publication/356592279_Service_Quality_And_Its_Impact_On_Customer_Satisfaction)
- Brady, K. & Cronin, J. (2001). *Some New Thoughts on Conceptualizing Perceived Service Quality*: <https://journals.sagepub.com/doi/10.1509/jmkg.65.3.34.18334>
- Chand, S. (N.D.), '7 Important Characteristics of Services', *Your Article Library* [Online]. Available at <https://www.yourarticlelibrary.com/marketing/7-important-characteristics-of-services/30016>
- Chang, H-J., Huang, K-C& Wu,C-H (2006), "Determination of Sample Size in Using Central Limit Theoram for Weibull Distribution" "*Information and Management Science, Vol 17 No.3,pp 31-45*.
- Dabholkar, P. et al., (2000). *A Comprehensive Framework for Service Quality: An Investigation of Critical Conceptual and Measurement Issues Through a Longitudinal Study*. *Journal of Retailing*, 76(2), 139-173. doi:

- Dotchin, J. & Oakland, J. (1994). *Total Quality Management in Services: Part 3: Distinguishing Perceptions of Service Quality*. International Journal of Quality & Reliability Management, 11(4), 6-28. Doi
- Fengmin, Z., Baijun, W., Jiangtao, B., Li, L., & Patwary, A. K. (2022). Investigating revisit intention of medical tourists in China through nutritional knowledge, perceived medical quality, and trust in the physiologist: A recommendation on health tourism policy measures. *Frontiers in Public Health*, 10, 893497.
- Hazbar, A. M. H., Alem Mohammed, A., & Karim, A. K. A. (2019). An Empirical Study of Factors Influencing hotel customers' online booking Intention. *مجلة العلوم التربوية و الدراسات الإنسانية*, (5), 1-17.  
<https://www.emerald.com/insight/content/doi/10.1108/02656719410057926/full/html>  
<https://www.sciencedirect.com/science/article/abs/pii/S0022435900000294?via%3Dihub>
- Li, L., Ragavan, N. A., Patwary, A. K., & Baijun, W. (2022). Measuring patients' satisfaction toward health tourism in Malaysia through hospital environment, nutritional advice, and perceived value: A study on Chinese exchange students. *Frontiers in public health*, 10, 893439.
- Li, L., Wu, B., & Patwary, A. K. (2022). How marine tourism promote financial development in sustainable economy: new evidences from South Asia and implications to future tourism students. *Environmental Science and Pollution Research*, 29, 1155-1172.
- Li, L., Wu, B., & Patwary, A. K. (2022). The psychosocial factors affecting chinese Outbound Exchange and mobility students' academic performance during COVID-19. *Frontiers in psychology*, 13, 872516.
- Mumtaz Ali Memon, Hiram Ting, Jun-Hwa Cheah, Ramayah Thurasamy, Francis Chuah and Tat Huei Cham (2020). *Sample Size For Survey Research: Review And Recommendations*.
- Patwary, A. K., Roy, B., Hoque, R., & Khandakar, M. S. A. (2019). Process of developing a community based tourism and identifying its economic and social impacts: An Empirical study on Cox's Bazar, Bangladesh. *Pakistan Journal of Humanities and Social Sciences*, 7(1), 1-13.
- Sumethokula, P., Patwary, A. K., Srinuanpanc, B., Srinuanpand, C., Suwandee, P., Thammathikul, A., & Phanong, W. (2020). The potential of new tour repackaging for creative tourism among entrepreneurs in Nakhon Si Thammarat. *International Journal of Innovation, Creativity and Change*, 13(10), 1752-1771.
- Wu, B., Liu, S., Wang, J., Tahir, S., & Patwary, A. K. (2021). Assessing the mechanism of energy efficiency and energy poverty alleviation based on environmental regulation policy measures. *Environmental Science and Pollution Research*, 28, 40858-40870.
- Wu, B., Zhai, B., Mu, H., Peng, X., Wang, C., & Patwary, A. K. (2021). Evaluating an economic application of renewable generated hydrogen: A way forward for green economic performance and policy measures. *Environmental Science and Pollution Research*, 1-1

# UNIVERSITY STUDENTS PERCEPTION TOWARDS HIPSTER CAFÉ IN KOTA BHARU, KELANTAN

Nur Afiqah Binti Ariffin , Nor Zahirah Binti Mustafa , Muhammad Syahir Danish Bin Sopiri , Nur anis Aqilah Binti Suhaimi , & \* Prof Madya Dr Mohd Fadil Bin Mohd Yusof

*Faculty of Hospitality, Tourism and Wellness, Universiti Malaysia Kelantan*

*Corresponding email: [fadil@umk.edu.my](mailto:fadil@umk.edu.my)*

---

## ABSTRACT

Hipster café has gotten a lot of attention from university students. Kota Bharu is also one of the district that has seen a increase in the number of hipster cafés, which has taken the populace by surprise. With the advent of hipster cafes in Malaysia's coffee industry, hipster cafe operators are strategically spreading their wings in order to capture market share and obtain a competitive advantage over competitors. Customers will favour a hipster cafe that can offer higher-quality items and customer service. This study investigated the impact of Hipster Cafe Services, Culture, and Café Environment on University Students' Perceptions Towards Hipster Cafes in Kota Bharu. The main data for the study will be collected using a structured questionnaire, and the analysis used SPSS version 27 software. The survey was distributed to 384 respondents of students perception towards hipster café. It is possible to conclude that cafe services, culture, and café environment have a considerable favourable impact on students' perceptions of hipster cafes.

**Keywords:** Hipster Café, Café Services, Hipster, Culture, Café Environment , Students Perception .

---

## INTRODUCTION

Hipsters can be of any ethnicity or age, but they tend to be white and between the ages of 20 and 35. Hipsters like independently owned businesses, especially coffee shops and breweries, and are typically found in urban areas. Hipsters prefer independent music and performers that the general public hasn't yet found. Hipsters typically enjoy unique clothing, frequently donning vintage or thrift store finds as well as retro shoes or boots that look well-

worn. Hipsters typically come from middle- or upper-class backgrounds. They are known for their pursuit of authenticity as well as their goal to exude coolness and originality. For comedic irony, they might wear graphic t-shirts, moustache, or other body art. For hipsters, progressive politics are the norm.

The ambiance and overall impression that a space's design has on its users are heavily influenced by it. Ambiance is the general environment of a space that enables people to sense and become immersed in it. The aesthetics, interior design, and staff demeanor all contribute to the hipster cafe's ambiance. It wouldn't be otherwise, but the correct atmosphere has a strong impact on inhabitants' senses. By combining elements like colour, perfume, music, and lighting, the decor can enhance the ambiance. The aura of the environment, whether emotional or physical, has a significant impact on the clientele's mood.

Lastly, hipsters' food has become a new culinary culture, an array of fusion food outside the norm or mainstream. The identity attached to this has evolved into an influential factor that draws customers. Expectation of food quality at hipster cafes gradually increases with the growth of high income population in a town Chan Jess Min (2021). Beside that, Hipster cafes in Malaysia are typically identified by the inventive names given to foods and drinks, the products utilized, and the unusual presentation. According to Syakirah (2015), hipster food culture in Malaysia has generated a new obsession, and its effect not only influences their food preparation, consumption, or culinary ways, but also their lifestyles. People have been inspired to practise new eating habits as a result of the current waves of food trend changes in eating habits, dining place, eating time, and food types are related with social transformation in a community. As a result, the goal of this study is to look into the relationship between service quality, café culture, and café environment and satisfaction with hipster cafés.

There are three objectives of this research:

1. To examine the relationship between the service quality influence the satisfaction towards Hipster Café.
2. To examine the relationship between the café culture influence the satisfaction towards Hipster Café.
3. To examine the relationship between the café environment influence the satisfaction towards Hipster Café.

## **SIGNIFICANCE OF THE STUDY**

### **Researchers**

The result of the study helps the researchers evaluate the relationship between student perception of hipster cafe service, hipster cafe culture, customer satisfaction, and hipster cafe environment. The results help researchers aspire to understand much about the factors that influence customers' satisfaction with hipster cafes.

### **Customer satisfaction**

This study provided information about customer satisfaction with hipster cafe services. This study evaluated a relationship between student perception of hipster cafe service, hipster cafe culture, customer satisfaction, and hipster cafe environment that relate to knowing the type of behavior that can be involved when going to a hipster cafe. Get to know the behavior of customers and the decision-making when an individual or group uses the services. Data gathered help owners know what factors influence them when dining in at hipster cafes.

### **Students perception**

The data provide student perception towards hipster cafes with information on how student perception of hipster cafe service, hipster cafe culture, customer satisfaction, and hipster cafe environment. The result enabled the student's perception to improve their services in hipster cafes in persuading people to dine at hipster cafes. These studies also make the hospitality sector especially hipster cafes that students' or customers' perception is related to customer satisfaction and leads customers to come and dine at hipster cafes.



## **LITERATURE REVIEW**

### **CAFE SERVICE QUALITY**

Service quality measures the superiority of brands in the travel, retail, hotel, airline, and restaurant industries. The quality of restaurant service influences customers' dining experiences. Service quality makes an initial impression on customers and influences their perception of quality. To maintain a sustainable competitive advantage, the service industry provides high-quality services to customers. Service quality is a measure of how well an organization delivers its services in comparison to its customers' expectations. Customers buy services in order to meet specific needs.

### **HIPSTER FOOD & CAFÉ**

As the popularity of hipster foods grows, increased, the number of hipster eateries increased as well. According to McCracken (2010), the hipster food culture retains characteristics that go far beyond popular cuisines. The study's findings will help us better understand the specific reasons that visitors from a hipster cafe choose to dine there on purpose.

### **FOOD QUALITY**

Food quality is a critical condition for meeting the consumer's needs and expectations. Customer loyalty is affected by food quality, and customers evaluate restaurants based on food quality. Food quality includes food taste, presentation, temperature, freshness, nutrition, and menu variety. The quality of the food influences customers' decisions to return to the restaurant. Academic curiosity is increasing in restaurant menus, as variety of menu items is regarded as a critical characteristic of food quality. Taste is a sensual aspect of food. After eating, the taste is evaluated.

## **QUALITY OF THE PHYSICAL ENVIRONMENT**

The quality of the physical environment both satisfies and attracts new customers. PEQ improves financial performance and provides customers with a memorable experience. Consumers judge a Cafe quality based on its cleanliness, quirky, comfortable welcome, physical environment quality, and other ambiance-creating amenities. The effect of physical environment quality on behaviour is visible in service businesses such as restaurants, hotels, hospitals, retail stores, and banks. Customer satisfaction is influenced by the physical environment. As a result, restaurants must create an appealing and distinct physical environment.

## **CUSTOMER SATISFACTION**

The term "customer satisfaction" is defined" as the customer's subjective assessment of the consumption experience, grounded on certain associations between the perceptions of the customer and objective characteristics of the product". Customer satisfaction is essential the degree to which a consumption Experience makes one happy. Customer satisfaction is essential defined as "a comparison of a consumer's perceived level of product or service performance, quality, or other outcomes with an evaluative standard"

## **Research Hypothesis**

The study hypothesis seeks to ascertain whether there is a relationship between dependent and independent variables based on university students' views and perceptions of hipster cafe in Kota Bharu :

H1

There is a relationship between the service quality and customer satisfaction towards Hipster Café in Kota Bharu.

H2

There is a relationship between food quality and customer satisfaction towards Hipster Café in Kota Bharu.

H3

There is a relationship between café environment and customer satisfaction towards Hipster Café in Kota Bharu.

### Research Framework

The conceptual framework for this research is seen in Figure 2.4. The three factors that make up the independent variable that will be proposed are service quality, café culture, and café environment . The satisfaction towards Hipster Café is the dependent variable.

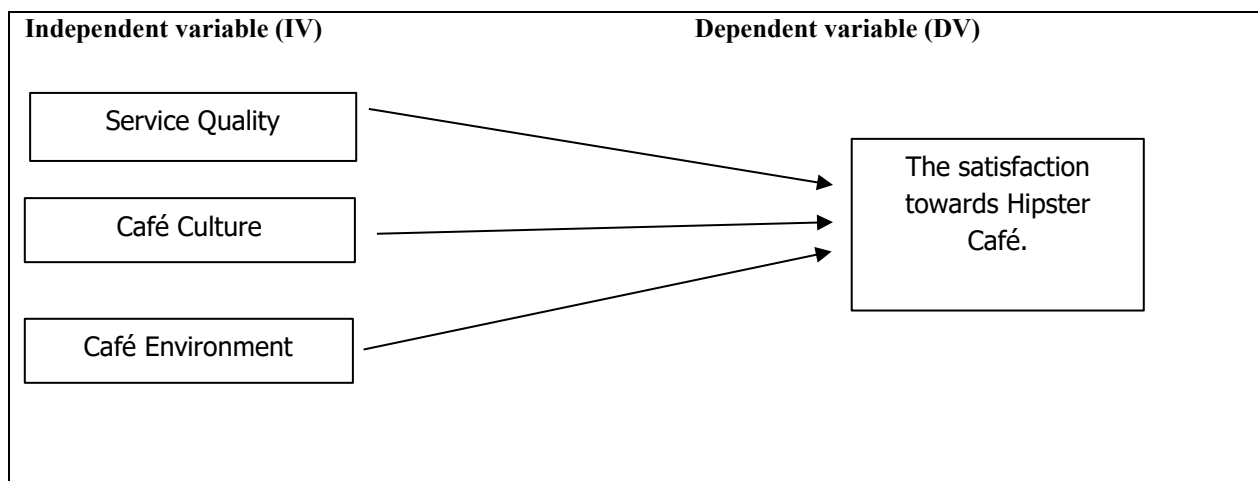

Figure 1: Conceptual Framework of the relationship between service quality, cafe culture, and cafe environment

## METHODOLOGY

### Research Design

The study's main objective is to determine the factors that influence university students views and perception towards hipster café in Kota Bharu, Kelantan. The primary objectives of description research as it described data associated with determinants of customer satisfaction in Hipster Café. Descriptive research is employed to collect information about the current state of a phenomenon in order to describe what exists in relation to variables in a given situation. Primary data refers to data that is gathered for the first time. Anderson (2006) stated that the data gathered must be unbiased, measurable, and statistically valid. It can obtain numerical data for data analysis by implementing mathematical models in this research by using quantitative research William (2007). A questionnaire is a series of questions or items used to gather

information about respondents' attitudes, experiences, or opinions. The questionnaire that was used has mostly shuttered questions that are easier for consumers to answer and multiple choice alternatives. Secondary data was gathered by consulting websites, articles, journals, and so on.

In general, there are three types of business research designs, exploratory research, descriptive research, and survey research. Descriptive research is used to describe a population in terms of important variables according to Zikmund, Babin, Carr and Griffin,( 2013). This is done to investigate the relationship and impact of each variable. It donates data gathered for the purpose of description and interpretation. In fact, this design is frequently used to determine the relationship between independent variables and dependent variables. This is not direct evidence of causality because the outcomes are based on significant and appropriate information, which includes proper analysis, interpretation, comparison, and relationship Salaria, (2012).

### Population and sample size

Overall, the population all university students in Kota Bharu is 9548 students. The research population of this study only involves university students in Kota Bharu. The target population for university students is 10,000 person. To determine the sample size, Krejcie and Morgan (1970) sample was used in this study. Krejcie & Morgan (1970):

S = sample size

$X^2$  = the table value of chi-square for 1 degree of freedom at the desired confidence level (3.841)

N = the population size of domestic tourist in a year

P = the population proportion (assumed to be 0.5 since this would provide the maximum sample size)

d = the degree of accuracy expressed as a proportion (0.05)

$$S = \frac{x^2 NP(1 - P)}{d^2(N - 1) + (x^2 P(1 - P))}$$

$$S = \frac{3.841(2054000000)(0.5)(1 - 0.5)}{(0.05)^2(2054000000 - 1) + 3.841(0.5)((1 - 0.5))}$$

$$S = \frac{1972353500}{5135000.958}$$

$$S = 384.099$$

$$S = 384$$

The exact amount of sample size for the population are 384 but the return of the questionnaire answered by respondents collected the data for 385 respondents.

### **Data Collection**

Online surveys that used Google Forms were used as the initial data collection method in this study. The fact that this platform of technological tools is free and user-friendly is the reason why the researcher chose to use it. Additionally, it makes it simpler for the researcher to gather all the data from regional visitors. Fieldwork was the second stage of data collection. The questionnaire was also used as the primary data collection tool in this study. Respondents must complete all three parts of the section. To gather data, a questionnaire was given to the population of university students.

### **Sampling**

Sampling is a technique for obtaining data in academics to learn regarding a particular population by studying the findings of a sample of people rather than focusing on some specific individuals (Turner, 2020). Usually sampling method have the types which are probability sampling that all respondents can participate as a sample, then non-probability sampling is the sampling that take respondents who are have connection with the study. In this research, researcher use the convenience sampling method. This is because this method is easy to accessibility, geographic closeness, and availability at a specific time. Beside that, the researcher also use the non-probability sampling. This is because it will help researcher get the specific answer and also will help in order to achieve the objective of the research.

### **Research Instrument**

The items measuring the chosen research constructs were adopted from prior related research in the field of University students perception toward hipster cafe.

Table 1: Measurement items

Measurements	Number of items in the questionnaires	Scales used	Author

<b>Section A: Demographic information</b>	5	Adapt	Chia et al (2006)
<b>Section B: Hipster Cafe Service, Hipster Cafe Culture, Customer satisfied</b>	15	Adapt	Chia et al (2006)
<b>(Dependent Variables)</b> <b>Section C: Hipster Cafe Environment</b>	5	Adopt	Man et al (2019)

### Data Analysis

For the purpose of analyzing the primary data, researchers used SPSS version 27 (Statistical Programmers for Social Science). You can make tables and pie charts using the program-based data processing and analysis window known as SPSS. Researchers were helped by computers in reducing the amount of work needed to gather information and in performing quantitative analysis quickly and easily. To analyse quantitative data, the researcher employs Pearson's correlation, regression, reliability statistics, descriptive statistics, and more.

## FINDINGS

### Result of Frequency Analysis

#### Respondents' Profile Of Gender

Respondent's Profile Gender	Frequency N=384	Percentage %
Male	181	47.1%
Female	203	52.9%
Total	384	100%

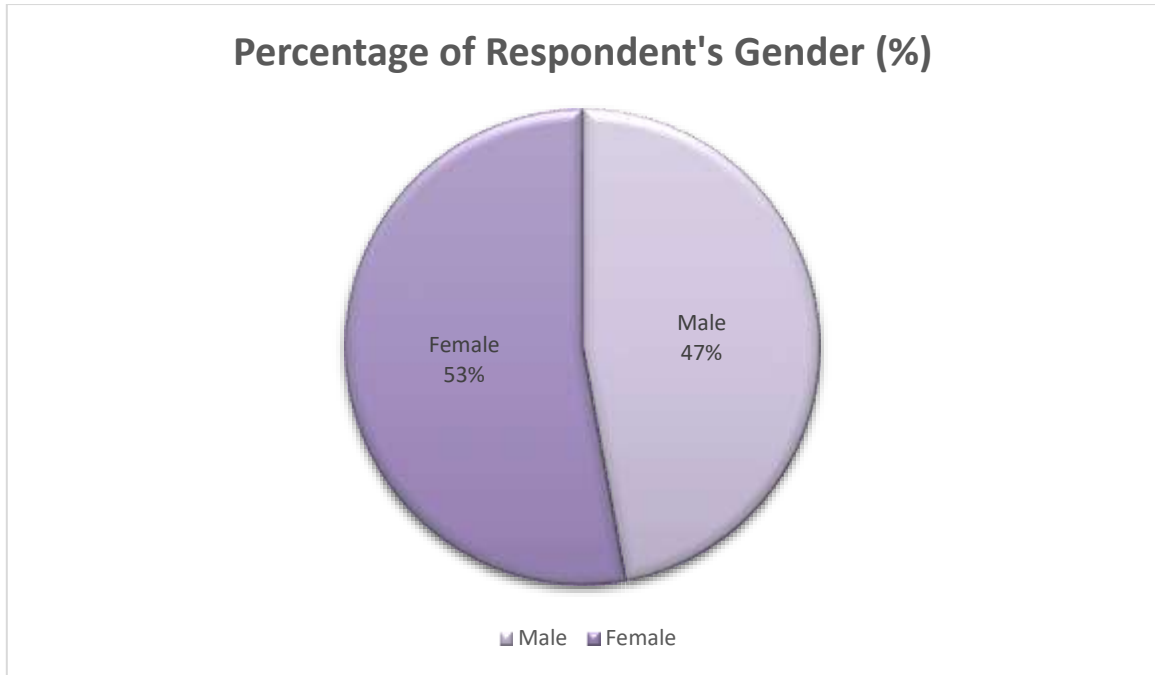
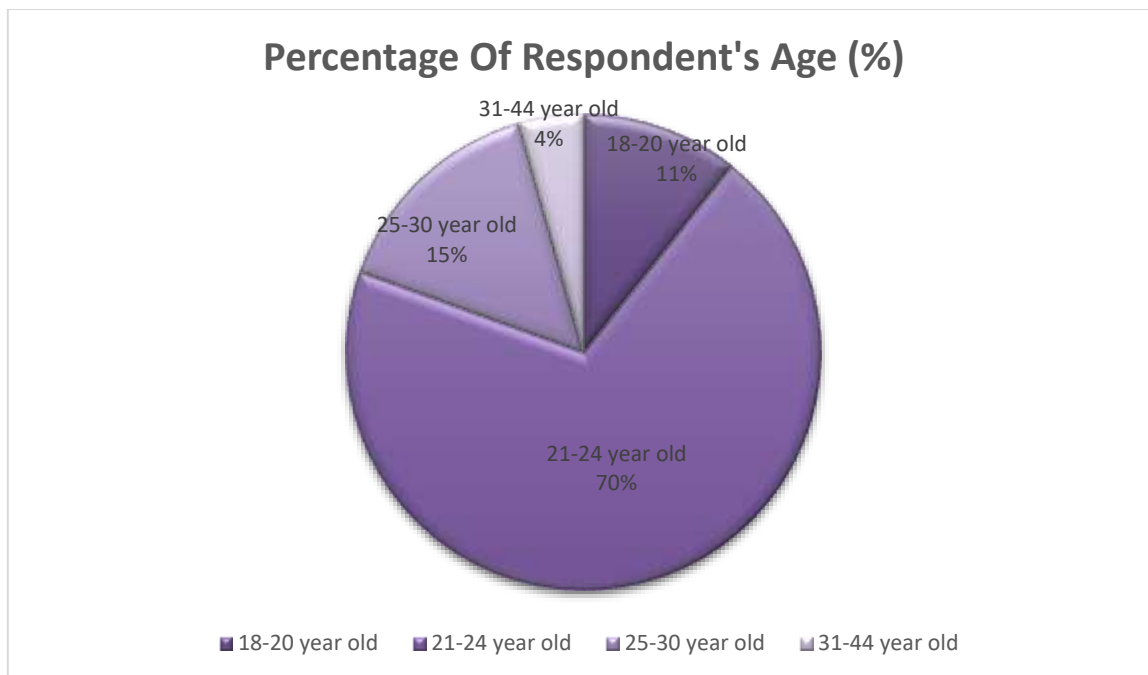

**Figure 4.1 The Percentage of Respondent's Gender**

Based on the demographic data from 384 respondents, a total of 203 respondents are female, accounting for 52.9% percent of the total, while male respondents account for 181 people, accounting for 47.1% percent of the total.

### Respondent's Demographic Profile Of Age

Respondent's Profile Age	Frequency N=384	Percentage %
18-20 years old	41	10.7%
21-24 years old	268	69.8%
25-30 years old	58	15.1%
31-44 years old	17	4.4%



**Figure 4.2 The Percentage Of Respondent's Age**

According to Table 4.5, respondents aged 21 to 24 years old have the most respondents to the study (268), accounting for 69.8% of the total number of study participants, while those aged 31 to 44 years old have the fewest study participants (17), accounting for 4.4% of all study participants. The age range of 25 to 30 years old had the second highest overall number of survey participants, with (58) people, or 15.1% of all responses. There were (41) respondents aged 18 to 20 years old, accounting for 10.7% of the total.

Respondent's Profile Race	Frequency N=384	Percentages %
Malay	316	82.3%
Chinese	33	8.6%
Indian	20	5.2%
Others	15	3.9%

**Respondent's Demographic Profile Of Race**



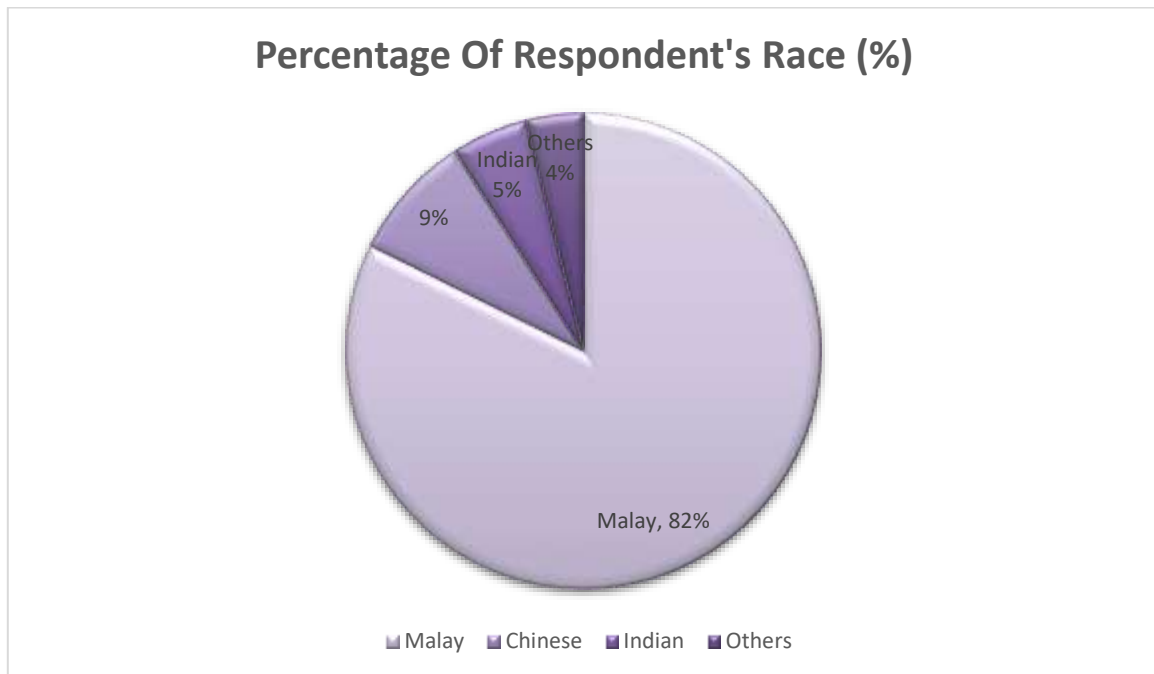

**Figure 4.3 The Percentages Of Respondent's Race**

According to the data, Malay those who responded had the highest value of 316 (82.3%), while Others had the smallest value of 15 (3.9%). While the Chinese had the second-greatest number of respondents with 33 (8.6%), Indians came in third with 20 (5.2%).

**Respondent's Profile Of Education Level**

Respondent's Profile Education Level	Frequency N=384	Percentages %
Secondary School	14	3.6%
Diploma/ STPM	127	33.1%
Degree	233	60.7%

Master / PhD	10	2.6%
Total	384	100%

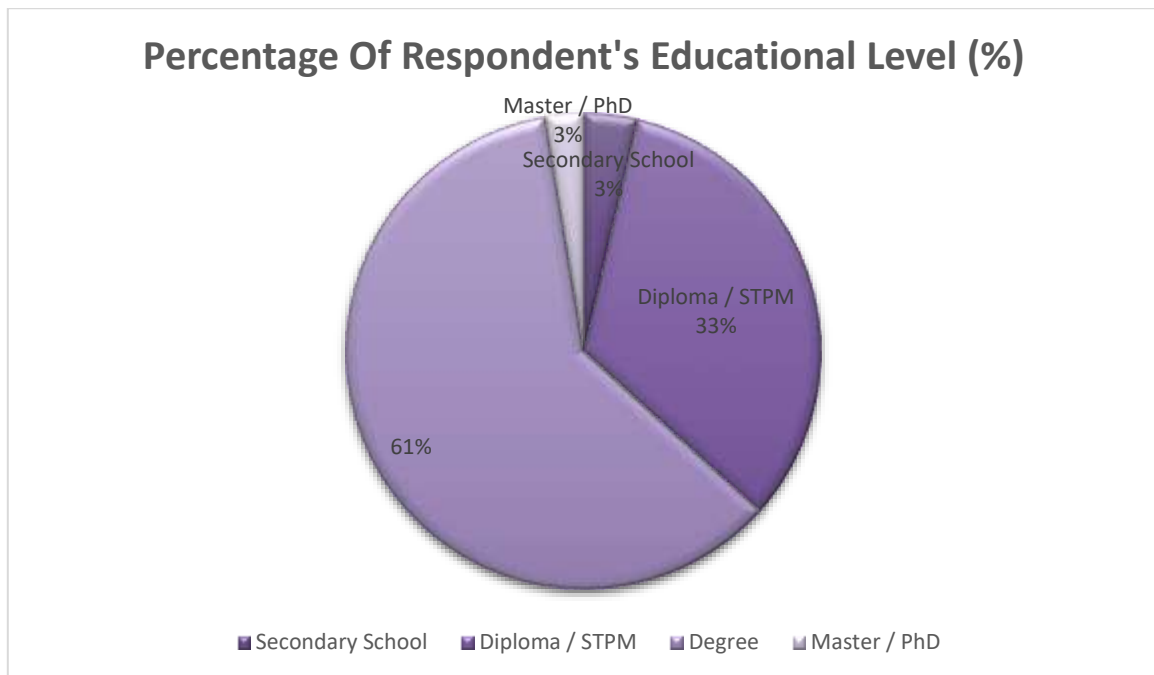

**Figure 4.4 Percentage Of Respondent's Educational Level**

The findings of table 4.7 show that the majority of respondents in this study have a degree and above, with a total of 233 people, or (60.7%). In addition, Diploma/ STPM recorded the second-highest value with 127 respondents (33.1%), followed by Master/PhD in the lowest place with 10 respondents, leading to a value of (2.6%) and secondary School with a total of 14 respondent's (3.6%).

## Result of Descriptive Analysis

### 4.5.1 Variable No 1

**Table 4.5.1 : Descriptive Analysis for Independent Variable (1) towards Hipster Café Service**

No	Item for variable No 1	Mean	Standard deviation
1	Did the host greet you upon arrival?	4.09	0.949

2	Does the service provide by hipster cafe workers the best?	4.22	0.769
3	Was the table cleared between dishes by bussers ?	4.27	0.834
4	Does hipster cafe workers are always dressed according to procedure and wear gloves when preparing food?	4.25	0.833
5	Did the WiFi and internet provided fast?	4.20	0.872

The scale for the Hipster Café Service is derived from the table above by adding the means and standard deviations for the five components. The measuring items' averages ranged from 4.09 to 4.27, and their standard deviations were between 0.769 and 0.949. So, the mean for the variable number one is strongly agreed.

#### 4.5.2 Variable No 2

**Table 4.5.2 : Descriptive Analysis for Independent Variable (2) towards Hipster Café Culture**

No	Item for variable No 2	Mean	Standard deviation
1	Do you think the existence of hipster cafes can influence food tourism among university students?	4.24	0.786
2	Do you think that outsiders or tourists will be more interested in visiting hipster cafes if they have viral food?	4.25	0.720
3	Is this hipster cafe culture suitable for all ages?	3.99	0.925
4	Does this hipster culture mostly emphasize unique and interesting store design?	4.35	0.704
5.	Has the increasingly popular hipster cafe culture in Malaysia influenced the interest of young people, especially university students, to make	4.40	0.694

	hipster cafes a place to meet friends or a place to study?		
--	--	--	--

The scale for the Hipster Café Culture is derived from the table above by adding the means and standard deviations for the five components. The measuring items' averages ranged from 3.99 to 4.40, and their standard deviations were between 0.694 and 0.925. Then, the mean for the variable number is agreed.

#### 4.5.3 Variable No 3

**Table 4.5.3 : Descriptive Analysis for Independent Variable (3) towards Hipster Cafe Environment**

No	Item for variable No 3	Mean	Standard deviation
1	Can the atmosphere outside the hipster cafe attract the attention of customers?	4.32	0.761
2	Can the interior decoration of hipster cafe influence in creating a calm and comfortable atmosphere?	4.42	0.715
3	Does the hipster cafe care about cleanliness and customer safety?	4.44	0.660
4	Is the atmosphere calm and quit affect the environment of hipster cafe?	4.39	0.704
5.	Is concept of hipster cafe make them more recognizable?	4.41	0.676

The scale for the Hipster Cafe Environment is derived from the table above by adding the means and standard deviations for the five components. The measuring items' averages ranged from 4.32 to 4.44, and their standard deviations were between 0.660 and 0.761. Next, the mean for the variable number three is greatly agreed.

#### Result of Reliability Test

**Table 4.2 The results of reliability analysis for the study variables**

No of items	Study variable	Cronbach's alpha	Remarks (acceptable/not acceptable)
5	Hipster Café Service	0.877	Acceptable
5	Hipster Café Culture	0.813	Acceptable
5	Hipster Café Environment	0.870	Acceptable
5	Customer Satisfied	0.858	Acceptable

## Pearson Correlation

### Correlation between Independent Variable 1 and Dependent Variable (H1)

**H1 : Hipster café service positively impact the customer satisfied.**

In this hypothesis, hipster café service and customer satisfied are described as the independent and dependent variables. The outcome of the association between these two variables is provided in table below.

**Correlations**

		Hipster cafe Service	Customer Satisfied
Hipster Cafe Service	Pearson Correlation	1	.478**
	Sig. (2-tailed)		<.001
	N	384	384
Customer Satisfied	Pearson Correlation	.478**	1
	Sig. (2-tailed)	<.001	
	N	384	384

\*\* . Correlation is significant at the 0.01 level (2-tailed).

\*\* . Correlation is significant at the 0.01 level (2-tailed).

Table 4.1 Correlation between hipster café service and customer satisfied.

Table 4.1 shows that the correlation between hipster café service and customer satisfied is 0.478. This discovery reveals the existence of a relationship between the variables.

The positive correlation coefficient of 0.478 demonstrated that their relationship is small but defined relationship. As a consequence, the hypothesis H1, which is used to assess the association between hipster café service and customer satisfied, is regarded as reasonable or accepted.

**Correlation between Independent Variable 1 and Dependent Variable (H2)**

**H2 : Hipster café culture positively impact customer satisfied.**

In this hypothesis, hipster café culture and customer satisfied are described as the independent and dependent variables. The outcome of the association between these two variables is provided in table below.

**Correlations**

		Hipster Cafe Culture	Customer Satisfied
Hipster Cafe Culture	Pearson Correlation	1	.639**
	Sig. (2-tailed)		<.001
	N	384	384
Customer Satisfied	Pearson Correlation	.639**	1
	Sig. (2-tailed)	<.001	
	N	384	384

\*\* . Correlation is significant at the 0.01 level (2-tailed).

\*\* . Correlation is significant at the 0.01 level (2-tailed).

Table 4.2 Correlation between hipster café culture and customer satisfied.

Table 4.2 shows that the correlation between hipster café culture and hipster customer satisfied is 0.639. This discovery reveals the existence of a relationship between the variables. The positive correlation coefficient of 0.639 demonstrated that their relationship is moderate. As a consequence, the hypothesis H2, which is used to assess the association between hipster café culture and customer satisfied, is regarded as unquestioned.

### Correlation between Independent Variable 1 and Dependent Variable (H3)

**H3 : Hipster café environment positively impact customer satisfied.**

In this hypothesis, customer satisfied and hipster café environment are described as the independent and dependent variables. The outcome of the association between these two variables is provided in table below.

		Hipster Cafe Environment	Customer Satisfied
Hipster Cafe Environment	Pearson Correlation	1	.633**
	Sig. (2-tailed)		<.001
	N	384	384
Customer Satisfied	Pearson Correlation	.633**	1
	Sig. (2-tailed)	<.001	
	N	384	384

\*\* . Correlation is significant at the 0.01 level (2-tailed).

\*\* . Correlation is significant at the 0.01 level (2-tailed).

Table 4.3 Correlation between hipster café environment and customer satisfied.

Table 4.3 shows that the correlation between customer satisfied and hipster café environment is 0.633. This discovery reveals the existence of a relationship between the variables. The positive correlation coefficient of 0.633 demonstrated that their relationship is relatively moderate. As a consequence, the hypothesis H3, which is used to assess the association between hipster café environment and customer satisfied, is regarded as has been approved.

## **DISCUSSION & RECOMMENDATION**

The study analyzing the relationship between students perception with hipster cafe service, hipster cafe culture, hipster cafe environment and customer satisfied. The purpose of this study is to determine the relationship between students perception with hipster cafe service, hipster cafe culture, and hipster cafe environment in Kota Bahru, Kelantan.

This study suggests that more research on hipster cafes in Kelantan should be conducted because this research is limited to university students only, it cannot draw any conclusions. The results of this study may be different if extended to the entire population in Kota Bahru Kelantan. As a result, instead of only focusing on university students, residents are also expected to answer the survey.

Research limitations are the study's weaknesses, which are frequently brought on by events beyond the control of the researcher. Data and participants are just two examples of these factors. For instance, the generalization of the results would be compromised if we were unable to obtain a random sample of participants for the study and instead had to use a convenience sampling strategy, indicating a study limitation. As we all know, not all students are from Kelantan, and not all students enjoy eating at hipster cafes. As a result, some students may not be interested in participating in the survey because they may not be familiar with the hipster cafes in Kota Bahru.

Additionally, conduct interviews with respondents or create some open-ended questions instead of having them respond to a scale questionnaire online. With the interview method, researchers may get a high response rate and can immediately follow up on questions with ambiguous or incomplete answers. As a result, this approach can clear up misunderstandings and significantly enhance study findings.

Finally, because the factors that may affect customer satisfaction with hipster cafe services are subject to change, future research should be conducted to stay up to date on these variables. It is possible to evaluate the variables that affect consumer trust, which might help business owners implement more effective marketing strategies. Future academics could develop a special framework for evaluating customer satisfaction with hipster cafe services. Due to the unpredictable nature of customer satisfaction with cafe services, local surveys must be carried out to determine how customers view the cafes and how this influences their level of satisfaction.



## CONCLUSION

In this research, all variables had significant and positively affecting the perception of university students towards Hipster Cafe at Kota Bharu . According to the result, all independents variable such as service quality, cafe culture and cafe environment caused influences to the dependent perception of university students. Future studies should start with a well-balanced population sample. An unbalanced sample will generate inconsistent results that favour only one group. The sample size should then be raised in order to obtain precise, accurate, and consistent results.

## REFERENCES

- Akter, M., Sadekin, M. N., & Patwary, A. K. (2020). An Empirical Study on Students' Satisfaction from Mawlana Bhashani Science & Technology University, Bangladesh. *Review of Economics and Development Studies*, 6(2), 363-379.
- Alom, S., Patwary, A. K., & Khan, M. M. H. (2019). Factors affecting the turnover intention of Bangladeshi migrants in the United Arab Emirates: An empirical study on the hotel industry. *International Journal of Innovation, Creativity and Change*, 8(3), 344-360.
- Amour (2009) Md Saleh, M. F., Abd. Halim, N., & Mohd Farid, A.-N. (2021). Food Tourism Motivation and Customer Satisfaction on Hipster Café in Johor Bahru, Malaysia. *Journal of Tourism, Hospitality and Environment Management*, 6(26), 155–162. Retrieved from <https://doi.org/10.35631/jthem.626013>
- Anderson (2006) & William (2007) & Zikmund, Babin, Carr and Griffin,(2013). & Salaria, (2012). (2023). Coursehero.com. Retrieved from <https://www.coursehero.com/file/p1f8ullo/evaluating-the-results-of-the-research-This-chapter-has-been-classified-into-few/>
- Bitner (1990), Oliver & DeSarbo (1988), Parasuraman et al, (1988), Kandampully, J., Mok, C., and Sparks, B., (2001). Howard and Sheth (1969) Retrieved from
- Chuan, C. L. (2006b). Sample Size Estimation Using Krejcie And Morgan And Cohen Statistical Power Analysis: A Comparison. *Jabatan Penyelidikan*. Retrieved from <https://www.researchgate.net/profile/Christie-Entika/post/Between-Krejcie-and-Morgan-1970-tables-Cohen-1992-in-deciding-sample-size-which-one-do-you-prefer-as-both-approaches-have-its-own-critics/attachment/59d626526cda7b8083a22f13/AS%3A489574523772930%401493735070267/download/SAMPLE+SIZE+ESTIMATION+USING+KREJCIE+AND+MORGAN+AND.pdf>
- Descriptive Statistics: Definition, Overview, Types, Example. (2022, August 1).
- Duman, F. (2020). Effects of Coffee Shops' Food Quality, Service Quality and Ambience Quality on Customer Satisfaction and Loyalty in Batman, Turkey. *International Journal of Innovative Approaches in Social Sciences*, 4(3), 54–68. Retrieved from <https://doi.org/10.29329/ijiasos.2020.278.1>
- Fengmin, Z., Baijun, W., Jiangtao, B., Li, L., & Patwary, A. K. (2022). Investigating revisit intention of medical tourists in China through nutritional knowledge, perceived medical quality, and trust in the physiologist: A recommendation on health tourism policy measures. *Frontiers in Public Health*, 10, 893497.

- Gahfoor, R. Z. (2020b). Satisfaction and revisit intentions at fast food restaurants. *Future Business Journal*, 6(1). Retrieved from
- Hazbar, A. M. H., Alem Mohammed, A., & Karim, A. K. A. (2019). An Empirical Study of Factors Influencing hotel customers' online booking Intention. *مجلة العلوم التربوية و الدراسات الإنسانية*, (5), 1-17.
- Hill, W. (2015). A hipster history: Towards a postcritical aesthetic. *Critical Studies in Fashion & Beauty*, 6(1), 45–60. Retrieved from [https://doi.org/10.1386/csfb.6.1.45\\_1](https://doi.org/10.1386/csfb.6.1.45_1)
- Hipster Cafe: Case Study On Modern Cafe In Malaysia | Bartleby*. (n.d.). [www.bartleby.com](http://www.bartleby.com). <https://www.bartleby.com/essay/Hipster-Cafe-Case-Study-On-Modern-Cafe-FC6JMLCWFCU>
- Hussain and Ali (34). How does the Ambience of Cafe Affect the Revisit Intention Among its Patrons? *A S on the Cafes in Ipoh, Perak*. (n.d.). ResearchGate. Retrieved from [https://www.researchgate.net/publication/323362226\\_How\\_does\\_the\\_Ambience\\_of\\_Cafe\\_Affect\\_the\\_Revisit\\_Intention\\_Among\\_its\\_Patrons\\_A\\_S\\_on\\_the\\_Cafes\\_in\\_Ipoh\\_Perak](https://www.researchgate.net/publication/323362226_How_does_the_Ambience_of_Cafe_Affect_the_Revisit_Intention_Among_its_Patrons_A_S_on_the_Cafes_in_Ipoh_Perak)
- International Conference on Entrepreneurship, Business, Tourism and Hospitality *Organized By: Icebth 2021. (N.D.)*. Retrieved from <http://myscholar.umk.edu.my/bitstream/123456789/2230/1/full%20proceeding%20ICEBTH2021.pdf>
- Li, L., Ragavan, N. A., Patwary, A. K., & Baijun, W. (2022). Measuring patients' satisfaction toward health tourism in Malaysia through hospital environment, nutritional advice, and perceived value: A study on Chinese exchange students. *Frontiers in public health*, 10, 893439.
- Li, L., Wu, B., & Patwary, A. K. (2022). How marine tourism promote financial development in sustainable economy: new evidences from South Asia and implications to future tourism students. *Environmental Science and Pollution Research*, 29, 1155-1172.
- Li, L., Wu, B., & Patwary, A. K. (2022). The psychosocial factors affecting chinese Outbound Exchange and mobility students' academic performance during COVID-19. *Frontiers in psychology*, 13, 872516.
- Patwary, A. K., Roy, B., Hoque, R., & Khandakar, M. S. A. (2019). Process of developing a community based tourism and identifying its economic and social impacts: An Empirical study on Cox's Bazar, Bangladesh. *Pakistan Journal of Humanities and Social Sciences*, 7(1), 1-13.
- Sumethokula, P., Patwary, A. K., Srinuanpanc, B., Srinuanpand, C., Suwandee, P., Thammathikul, A., & Phanong, W. (2020). The potential of new tour repackaging for creative tourism among entrepreneurs in Nakhon Si Thammarat. *International Journal of Innovation, Creativity and Change*, 13(10), 1752-1771.
- Wu, B., Liu, S., Wang, J., Tahir, S., & Patwary, A. K. (2021). Assessing the mechanism of energy efficiency and energy poverty alleviation based on environmental regulation policy measures. *Environmental Science and Pollution Research*, 28, 40858-40870.
- Wu, B., Zhai, B., Mu, H., Peng, X., Wang, C., & Patwary, A. K. (2021). Evaluating an economic application of renewable generated hydrogen: A way forward for green economic performance and policy measures. *Environmental Science and Pollution Research*, 1-15.

# FACTORS THAT MOTIVATE UNIVERSITY MALAYSIA KELANTAN'S STUDENTS TO PARTICIPATE IN CULTURAL TOURISM ACTIVITIES

*AZRIN AINA BINTI MOHAMAD ZAHARI BINTI MOHAMAD ZAHARI, ARFAH  
ATIRABINTI ABD RAHIM, BAOYEE A/L AMRAN, CHE KU NORFARIZATUL  
BINTI CHE KU ABDULLAH*

*Faculty of Hospitality, Tourism and Wellness, University Malaysia  
Kelantan Corresponding email:*

---

## **ABSTRACT**

A study to identify factors that encourage University Malaysia Kelantan students to participate in cultural tourism activities. A better understanding of this topic is to find the truth as far as the factors that are likely to encourage student involvement in participating in cultural activities. Also, this research is to investigate what draws students from University Malaysia Kelantan to engage in cultural tourism. Study participants were college students interested in learning more about the potential, benefits, and impact of cultural tourism activities for themselves. This research is to compare student motivation at the university's three different campuses (Jeli, Kota, and Bachok). Students at the University of Malaysia Kelantan will be polled using a questionnaire, followed by data analysis and study-related issues. The results of the study found that student involvement was driven by motivation, education, and the influence of friends to experience the experience of participating in cultural tourism activities. The result of this work helps and persuades the situation in attracting students' interest in participating in cultural activities among the students of University Malaysia Kelantan.

**Keywords:** cultural tourism activities, students, motivation, youth, education, tourism

---

## **INTRODUCTION**

Cultural tourism has gained significant attention as a dynamic and enriching aspect of the travel industry, allowing individuals to explore diverse cultural traditions, historical sites, and artistic expressions. For universities, cultural tourism presents a valuable opportunity to enhance students' academic experiences, promote cultural exchange, and foster personal growth. This research study aims to investigate the factors that motivate students from University Malaysia Kelantan (UMK) to actively participate in cultural tourism activities. Cultural tourism offers students a unique avenue to engage with different cultures, expand their knowledge, and develop a global perspective. UMK, situated in Kelantan, Malaysia, is a higher education institution that embraces a rich tapestry of cultural diversity within its student body. Recognizing the potential benefits of cultural tourism, it becomes essential to understand the factors that drive UMK students to participate in such activities and explore their motivations.

The exploration of the factors that motivate UMK students to engage in cultural tourism is crucial for developing tailored programs and initiatives that effectively capture their interest and encourage participation. By identifying these motivating factors, UMK can provide students with opportunities that align with their preferences, thereby enhancing their cultural tourism experiences and maximizing the benefits derived from these activities. The objective of this study is to identify the factors that motivate Universiti Malaysia Kelantan's students to participate in cultural tourism activities. This objective entails conducting comprehensive research to identify and understand the various factors that drive UMK students' motivation to engage in cultural tourism activities. By exploring these factors, the research aims to provide a comprehensive understanding of the underlying motivations behind students' participation. Besides, to examine the most effective factor that contributes to Universiti Malaysia Kelantan's students' participation in cultural tourism activities.

This objective involves evaluating the relative effectiveness of different factors in driving UMK students' participation in cultural tourism activities. By analyzing the data collected and assessing the significance of each factor, the study aims to determine the primary motivation behind students' engagement. By accomplishing these objectives and addressing the research questions, this study aims to contribute to the existing knowledge

based on student participation in cultural tourism activities at UMK. The findings will provide valuable insights for UMK administrators, tourism authorities, and relevant stakeholders in designing targeted strategies and initiatives that cater to students' motivations and promote active involvement in cultural tourism. Ultimately, this research aims to enhance the cultural tourism experiences of UMK students and foster a deeper appreciation for cultural diversity within the university community.

## **SIGNIFICANCE OF THE STUDY**

### **LITERATURE REVIEW**

#### **Motivation**

According to Dubin (2002) stated, motivation is the set of influences that initiate and maintain an individual work in an organization. Motivation is the set of influences that initiate and maintain an individual's work in an organization. It propels them to take action and keep moving forward toward their goals. Employees need to feel inspired to increase their drive and dedication to achieving company objectives. Motivation is essential for employees to stay motivated and committed to their goals.

#### **Education**

When comparing the many definitions of education, Scheffler (1960) finds that the descriptive definition is the most widely used. The concept of "education" is referred to through various interchangeable names and concepts to describe its meaning and impact on students' lives. A programmatic definition of education emphasizes ideal practices rather than phenomena or words, often resulting in eulogies or slogans rather than concrete guidelines. This approach helps to convey the general public's understanding of education and its role in shaping students' lives.

#### **Youth**

According to United Nations refers to the transitional period between utter reliance on one's parents and the emergence of a sense of self-determination and community

among adults as the period often known as "youth" (World Economic Forum, 2013). The term "youth" is fluid and does not specify a specific age range, but most people adhere to the United Nations' definition of "youth" between 15 and 24. However, not everyone agrees, and the UNESCO definition is contextually contingent. Research excludes people older than 26 to ensure a stable sample.

### **Tourism**

Tourism is the act of traveling for leisure, business, or non-wage-related reasons, without considering compensated displacement. Studying tourism involves examining the traveler in a new setting, analyzing the industry's infrastructure and networks, and analyzing the complex dialectic between ordinary and remarkable. The tourist sector significantly impacts national and regional economies, boosting economies, creating jobs, improving transportation, and helping people from different backgrounds appreciate one another. Tourism professionals need a thorough understanding of a destination's tourism industry to find a balance that benefits the area's economy, environment, and culture. Many young people are participating in studying in other countries.

### **Culture Tourism**

Cultural tourism encompasses various aspects of a country, region, city, or town, such as art, film, language, sport, religion, architecture, cuisine, the natural world, and folk culture. It includes study tours, performing arts, festivals, visits to sites, and pilgrimages. Inadvertent cultural tourism occurs when travelers are forced to interact with locals without actively seeking it out. The World Tourism Organization (WTO) defines cultural tourism as the movement of people who fulfill the human need for diversity, elevating the individual's cultural level and generating new knowledge, experiences, and encounters. The tourism industry offers valuable opportunities to study how culture is made, and exposure to new cultures, customs, and lifestyles is a priceless benefit of travel.

## **METHODOLOGY**

In this study, the data were gathered using a One-on-one interview which is part of the qualitative. The researchers used interviews to collect data from the respondents on the factors that motivate University Malaysia Kelantan's students to participate in tourism and cultural activities. The goal of this research was to determine what drives students from University Malaysia Kelantan's to take part in tourism-related cultural activities.

### **Research Design**

The research aimed to understand the factors driving students from University Malaysia Kelantan's to participate in tourism-related cultural activities. A qualitative research approach was used, focusing on participants' lived experiences, phenomena, grounded theory, case studies, and critical case studies. This approach allows for inductive data collection and better understanding of viewpoints. Researchers traveled to the research site to gather data, keeping track of interviews and observations. Thematic analysis was employed to characterize and name the phenomenon, allowing for a thorough investigation of the issue.

## **DATA COLLECTION**

Information that cannot be quantified is referred to as qualitative information. Word clouds, idea maps, graph databases, timelines, and infographics are a few examples of data visualization techniques used to arrange and show information acquired from text, audio, and visual sources for end users. interviews with a single subject that the researcher chooses to employ for data collection. During the discovery phase of research, this style of interview is frequently utilized to ascertain needs, comprehend context, and elicit requests.

### **Sampling**

In this investigation, sampling will be used. The choice of study subjects from the general community is left up to the researcher, who is allowed to exercise his best judgment in doing so. The participants were chosen because they were knowledgeable about the subject, had a clear and concise way of expressing themselves, and were willing to cooperate with the researcher in gathering data.

There are three University Malaysia Kelantan groups on the Kelantan selected which are University Malaysia Kelantan's Kota Bharu Faculty of Entrepreneurship and Business, University Malaysia Kelantan's Bachok Faculty of creative technology and Heritage, and last University Malaysia Kelantan Faculty of Basic Industry Jeli Agriculture.

## DATA ANALYSIS

The data collection method will be followed by data analysis. The research's most crucial element was data analysis. Thematic analysis was utilized in this study because it offers a flexible strategy and allows for incorrect data interpretation. Also, it was acceptable to approach knowledge, people's perspectives, opinions, and experiences in order to get the facts. A technique for assessing qualitative data called thematic analysis involves looking through data collection to find, examine, and report recurring themes (Braun and Clarke 2006). It highlights the key points in the account of the phenomenon under investigation (Daly et al., 1997).

**Table 1:** Six steps of thematic data analysis (Michelle E. Kiger & Lara Varpio,2020)

Step 1: Educating Yourself About the Information
Step 2: Generating Initial Codes
Step 3: Searching for themes
Step 4: Reviewing themes
Step 5: Defining and naming themes
Step 6: Producing and report manuscript



## FINDINGS

The study interviewed 6 University Malaysia Kelantan students, including 2 from Kota Bharu, 2 from Bachok, and 2 from Jeli, to analyze their opinions on cultural tourism participation. Demographic information included age, gender, race, and marital status. Participants answered ten questions about factors motivating them to participate in cultural tourism activities. The interviews were helpful in analyzing data.

**Table 2: Respondent profile**

Characteristics		frequency
Gender	Male	2
	Female	4
Race	Malay	6
	Chinese	0
	Indian	0
Marital status	21-30 years old	6
Educational level	Bachelor of degree	6

Summary of the respondent profile state in table 1. That have 6 respondents for this study, which included 2 students from campus Kota Bharu, 2 students from Campus Bachok and 2 students from Campus Jeli. The participant's demographic information is shown in table. This study focuses on opinions about the potential of University Malaysia Kelantan's participants in cultural tourism. The demographic information that

the researchers asked for were the participant's age, gender, race, marital status. Each participant was interviewed to answer ten questions regarding the factors that motivate University Malaysia Kelantan's students to participate in cultural tourism activities.

## **DISCUSSION AND RECOMMENDATION**

Malaysia offers numerous tourist cultural activities for students from Kota Bharu, Bachok, and Jeli. These activities include architectural and archaeological treasures, culinary activities, festivals, historical sites, monuments, museums, national parks, wildlife sanctuaries, religious sites, temples, and churches. University Malaysia Kelantan has three campuses: Kota Bharu, Bachok, and Jeli. Kota Bharu's tourism faculty provides students with opportunities to enjoy recreation and study abroad. The campus's unique focus on business, architecture, and agriculture makes it an ideal location for activities tailored to UMK students.

Tourism-related cultural events encourage cross-cultural interaction, deepen awareness, and promote tolerance and respect among students. Educational activities like historical sites, museums, and performances broaden perspectives and enhance personal skills like communication, adaptability, teamwork, and problem-solving.

## **CONCLUSION**

This research investigates Students University Malaysia Kelantan's participate in culture tourism activities. Data was collected from students University Malaysia Kelantan's, contributing many students to participate in cultural tourism activities. However, cultural tourism activity gives many benefits to the students to increase their knowledge and learn about the history of the past that made us free from the colonists of antiquity.

## REFERENCES

- Adina, N., & Medet, Y. (2012). *Cultural tourism motivation – the case of Romanian youths*. *Annals of Faculty of Economics*. Retrieved January 17, 2023, from <https://econpapers.repec.org/RePEc:ora:journal:v:1:y:2012:i:1:p:548-553>
- Akter, M., Sadekin, M. N., & Patwary, A. K. (2020). An Empirical Study on Students' Satisfaction from Mawlana Bhashani Science & Technology University, Bangladesh. *Review of Economics and Development Studies*, 6(2), 363-379.
- Alom, S., Patwary, A. K., & Khan, M. M. H. (2019). Factors affecting the turnover intention of Bangladeshi migrants in the United Arab Emirates: An empirical study on the hotel industry. *International Journal of Innovation, Creativity and Change*, 8(3), 344-360.
- Attride-Stirling J.(2001). *Thematic Networks: An analytic tool for qualitative research*. (n.d.). Retrieved January 17, 2023, from <https://journals.sagepub.com/doi/10.1177/146879410100100307> [avant-garde-of-independent-trav](#)
- Baron, S. P. (1983). *Chain shifts in Chinese historical phonology : Problems of motivation and functionality*. Brill. Retrieved January 4, 2023,
- Barton, A. (2005). *The conceptual arguments concerning accounting for Public Heritage Assets: A note*. *Accounting, Auditing & Accountability Journal*. Retrieved January 17, 2023, from <https://www.emerald.com/insight/content/doi/10.1108/09513570510600774/full/h Behavior-Robert-Kreitner/dp/0078029368>
- Bizirgianni, & P. Dionysopoulou. (2013). *The Influence of Tourist Trends of Youth Tourism through Social Media (SM) & Information and Communication Technologies (ICTs)*☆. *Procedia - Social and Behavioral Sciences*; <https://www.semanticscholar.org/paper/The-Influence-of-Tourist-Trends-of->
- Boyatzis RE.(1998). *Transforming qualitative information: thematic analysis and code development*. Thousand Oaks (CA): Sage.Retrieved January 17, 2023, from <https://psycnet.apa.org/record/1998-08155-000>
- Braun, V. and Clarke, V. (2006) *using thematic analysis in psychology*. Retrieved January 17, 2023, from <https://crispindia.org/wp-content/uploads/2016/11/Using->
- Braun, V., & Clarke, V. (2012). *Thematic Analysis*. in H. , *APA Handbook of Research Methods in Psychology, vol. 2 research designs quantitative, qualitative, neuropsychological, and biological* (pp. 57-71). Retrieved January 17, 2023, from <https://www.scirp.org/%28S%28351jmbntvnsjt1aadkposzje%29%29/reference/ref Choice>. Deep Blue Repositories. Retrieved January 4, 2023, from <https://deepblue.lib.umich.edu/handle/2027.42/116285> [conference-sustainable-tourism-development](#)
- Constitution, F.* (2006). - *laws of Malaysia Federal Constitution incorporating all amendments up to*. Studocu. Retrieved January 17, 2023, from <https://www.studocu.com/my/document/international-islamic-university->
- Current population estimates, Malaysia, 2022 . *Department of Statistics Malaysia Official Portal*. Retrieved January 15, 2023, from <https://www.dosm.gov.my/v1/index.php?r=column%2FcthemByCat&cat=>

[d=YT\\_uqD4G94sC](#)

Daly, J., Kellehear, A., & Gliksman, M. (2001). *The Public Health Researcher: A Methodological Guide*. Amazon. Retrieved January 17, 2023, from <https://www.amazon.com/Public-Health-Researcher-Methodological-Dionysopoulou/1f45d05ce8c77a8e900c30473e23e0782b1973f4-discourse-Hassan-Habil/df03ac43e86c3a98231006aacdb00326146b07e2-document-semantic-and-infer>

Dubin, D., Renear, A., Sperberg-MCQueen, C. M., & Huitfeldt, C. (2002). *A logic programming environment for document semantics and inference*. University of Illinois Urbana-Champaign. Retrieved January 4, 2023, from <https://experts.illinois.edu/en/publications/a-logic-programming-environment-for->

Fengmin, Z., Baijun, W., Jiangtao, B., Li, L., & Patwary, A. K. (2022). Investigating revisit intention of medical tourists in China through nutritional knowledge, perceived medical quality, and trust in the physiologist: A recommendation on health tourism policy measures. *Frontiers in Public Health*, 10, 893497.

Francisco, C. B. (2012). Traditional Delicacies in Malaysia You'd Want to Taste [Web blog]. Retrieved from <http://www.brighthubeducation.com/social-studies->

Ghuman, P. A. S. (1996). *Assimilation or integration? A study of Asian adolescents*.

Google Books. Retrieved January 4, 2023, from [https://books.google.com/books/about/Motivation\\_Beliefs\\_and\\_Organizational\\_T](https://books.google.com/books/about/Motivation_Beliefs_and_Organizational_T)

Green & Butkus T. (1999). *Motivation, beliefs, and organizational transformation*.

[Guide/dp/0195540751](#)

Guilford JP (1967) *The nature of human intelligence*. New York. Retrieved January 17, 2023, from <https://psycnet.apa.org/record/1967-35015-000>

Haigh, R.(1995) : *Backpackers in Australia In: Bureau of Tourism Research, Canberra (1995) No.20, p. 12-34*. Retrieved January 17, 2023, from <https://catalogue.nla.gov.au/Record/2208919>

Hassan, H., Habil, H., & Nasir, Z. M. (2008). *Persuasive strategies of tourism discourse*. Semantic Scholar. Retrieved January 17, 2023, from <https://www.semanticscholar.org/paper/Persuasive-strategies-of-tourism->

Hazbar, A. M. H., Alem Mohammed, A., & Karim, A. K. A. (2019). An Empirical Study of Factors Influencing hotel customers' online booking Intention. *مجلة العلوم التربوية و الدراسات الإنسانية*, (5), 1-17.

[help/123358-traditional-delicacies-of-malaysia/](#)

Hofstede G. H.(2001) . *Culture's consequences: Comparing values, behaviors, institutions and organizations across nations*. Google Books. Retrieved January 4, 2023, from [https://books.google.com/books/about/Culture\\_s\\_Consequences.html?id=w6z18L](https://books.google.com/books/about/Culture_s_Consequences.html?id=w6z18L)

Horak, S. & Weber, S. (2000) : *Youth Tourism in Europe: Problems and Prospects*. In: *Tourism Recreation Research (2000) Vol. 25, No.3, p. 37-44*. Retrieved January

17, 2023, from  
<https://www.tandfonline.com/doi/abs/10.1080/02508281.2000.11014923>

<https://doi.org/10.1163/19606028-90000264>  
[humanities-medals/national-trust-historic-preservation](https://www.tandfonline.com/doi/abs/10.1080/02508281.2000.11014923)  
[interviews-and-focus-Marks-](https://www.tandfonline.com/doi/abs/10.1080/02508281.2000.11014923)  
[J\\_1VsC](https://www.tandfonline.com/doi/abs/10.1080/02508281.2000.11014923)

Jafari M, Papp T, Schiffmann D, & Melanoma Res (1995) *The state of melanoma: Emergent challenges and opportunities*. Clinical cancer research : an official journal of the American Association for Cancer Research. Retrieved January 17, 2023, from <https://pubmed.ncbi.nlm.nih.gov/33414132/>

King, B. E. M., & Gardiner, S. (2015). *Chinese international students. an avant-garde of independent travellers?* PolyU Scholars Hub. Retrieved January 17, 2023, from <https://research.polyu.edu.hk/en/publications/chinese-international-students-an->

Kreitner, R., & Kinicki, A. (2006). *Organizational behavior with olc*. Amazon.

Latham & Ernest (2006). *New Directions in goal-setting theory*. Retrieved January 4, 2023, from <https://journals.sagepub.com/doi/abs/10.1111/j.1467->

Lawler (2003) *Teachers as adult learners: A new perspective*. Retrieved January 4, 2023, from <https://onlinelibrary.wiley.com/doi/abs/10.1002/ace.95>

Li, L., Ragavan, N. A., Patwary, A. K., & Bajjun, W. (2022). Measuring patients' satisfaction toward health tourism in Malaysia through hospital environment, nutritional advice, and perceived value: A study on Chinese exchange students. *Frontiers in public health*, 10, 893439.

Li, L., Wu, B., & Patwary, A. K. (2022). How marine tourism promote financial development in sustainable economy: new evidences from South Asia and implications to future tourism students. *Environmental Science and Pollution Research*, 29, 1155-1172.

Li, L., Wu, B., & Patwary, A. K. (2022). The psychosocial factors affecting chinese Outbound Exchange and mobility students' academic performance during COVID-19. *Frontiers in psychology*, 13, 872516.

[Malaysia](https://www.tandfonline.com/doi/abs/10.1080/02508281.2000.11014923)  
[malaysia/constitutional-law/federal-constitution/36012233](https://www.tandfonline.com/doi/abs/10.1080/02508281.2000.11014923)

Maruschak, L. A. (1985, January 1). *The Ukrainian wedding: An examination of its rites, customs, and traditions*. HARVEST. Retrieved January 17, 2023, from <https://harvest.usask.ca/handle/10388/etd-07302012-115838>

McKercher, B. & Du Cros, H (2005). . *Cultural tourism*. Google Books. Retrieved January 4, 2023, from [https://books.google.com/books/about/Cultural\\_Tourism.html?id=jIf5oAEACA](https://books.google.com/books/about/Cultural_Tourism.html?id=jIf5oAEACA)

Michelle E. Kiger & Lara Varpio (2020) *Thematic analysis of qualitative data: A mee Guide no. 131*. Medical teacher. Retrieved January 17, 2023, from <https://pubmed.ncbi.nlm.nih.gov/32356468/>

Ministry of Tourism (MoT) (2013). *Malaysia Country Report*. 25th CAP-CSA and UNWTO Conference on Sustainable Tourism Development, 12-14 April Hydaerabad. Retrieved January 17, 2023, from <https://www.unwto.org/archive/asia/event/25th-csacap-joint-meeting-unwto->

Mosbah, A. (2014). *A Review of Tourism Development in Malaysia*. *European Journal of Business and Management*. 06. 01-09. Accessed 3 January 2023. [https://www.researchgate.net/publication/262105663\\_A\\_Review\\_of\\_Tourism\\_Development](https://www.researchgate.net/publication/262105663_A_Review_of_Tourism_Development)

National Trust for Historic Preservation. *The National Endowment for the Humanities*.

Negrusa, A., & Yolal, M. (1970). *Cultural tourism motivation – the case of Romanian*

Nella A, Christou E (2016). *Extending tourism marketing: Implications for targeting the senior* Retrieved January 17, 2023, from [https://www.researchgate.net/publication/326464305\\_Extending\\_tourism\\_marketing](https://www.researchgate.net/publication/326464305_Extending_tourism_marketing)

P. O. Adesemovo (2022). *Basic of education*. Retrieved January 10, 2023, from <https://www.researchgate.net/profile/Olufunmilayo-Abosedede>

P. O. Adesemovo (2022). *Basic of education*. Retrieved January 10, 2023, from <https://www.researchgate.net/profile/Olufunmilayo-Abosedede>

Palmeira, M. (2014). *Framework of tourism - jafar jafari 1091*. Academia.edu.

Pandy,R. Chettri,P. Kunwar,R. & Ghimire,G (1995) . Retrieved January 4, 2023, from <https://unesdoc.unesco.org/ark:/48223/pf000012261>

Panel Nell Leiper, Nell Leiper, Abstract Leiper & Résumé Leiper. (2002). *The framework of tourism: Towards a definition of tourism, tourist, and the Tourist Industry*. *Annals of Tourism Research*. Retrieved January 4, 2023, from <https://www.sciencedirect.com/science/article/pii/0160738379900033>

Pappas, S. (2023). *LiveScience*. Retrieved January 4, 2023, from <https://www.livescience.com/author/stephanie-pappas>

Patwary, A. K., Roy, B., Hoque, R., & Khandakar, M. S. A. (2019). Process of developing a community based tourism and identifying its economic and social impacts: An Empirical study on Cox's Bazar, Bangladesh. *Pakistan Journal of Humanities and Social Sciences*, 7(1), 1-13.

Pillai, A. (2018). *"Research on Tourism in Malaysia"*. Accessed 3 January 2023. [https://www.researchgate.net/publication/323389725\\_Research\\_on\\_Tourism\\_in\\_Malaysia](https://www.researchgate.net/publication/323389725_Research_on_Tourism_in_Malaysia)

Pine B., & Gilmore J.(2014).*Welcome to the experience economy*. Harvard Business

Pyo SS, Uysal M, & McLellan RW (1991) *A linear expenditure model for tourism demand*. *Annals of Tourism Research*. Retrieved January 17, 2023, from <https://www.sciencedirect.com/science/article/abs/pii/016073839190051C>

[C](https://www.sciencedirect.com/science/article/abs/pii/016073839190051C)

[r.html?id=tO1ZTbAows8C](https://www.sciencedirect.com/science/article/abs/pii/016073839190051C)

Retrieved January 17, 2023, from <https://ebn.bmj.com/content/3/3/68>

Retrieved January 17, 2023, from <https://versatile-learning.com/teachers/mr-g>

Retrieved January 17, 2023, from

<https://www.cabidigitallibrary.org/doi/book/10.1079/9780851994406.0000>

Retrieved January 17, 2023, from <https://www.weforum.org/reports/travel-and-tourism>

Retrieved January 4, 2023, from

[https://www.academia.edu/8443896/Framework\\_Of\\_Tourism\\_Jafar\\_Jafari\\_1091](https://www.academia.edu/8443896/Framework_Of_Tourism_Jafar_Jafari_1091)

Retrieved January 4, 2023, from <https://www.amazon.com/Organizational-Structure-Of-Tourism-Industry>

Retrieved January 4, 2023, from <https://www.neh.gov/about/awards/national-award-for-cultural-heritage>

- Review. Retrieved January 4, 2023, from [https://hbr.org/1998/07/welcome-to-](https://hbr.org/1998/07/welcome-to-Richards)  
 Richards G (2001) *Cultural Attractions and European tourism* | *cabi books*. (n.d.).
- Richards G. (2014). *Creative tourism*. Academia.edu. Retrieved January 4, 2023, from [https://www.academia.edu/1785786/Creative\\_Tourism\\_Richards\\_and\\_Raymond](https://www.academia.edu/1785786/Creative_Tourism_Richards_and_Raymond)
- Richards, G. and Wilson, J. (2003) *Today's youth travellers: Tomorrow's Global Nomads. New Horizons in independent youth and Student Travel*. Eldis. Retrieved January 17, 2023, from <https://www.eldis.org/document/A14560>
- Robert Shepherd, (2002). *Commodification, culture & tourism* Retrieved January 4, 2023, from <https://journals.sagepub.com/doi/abs/10.1177/146879702761936653>
- Robert, L., & Dennis, A. (2005). *Paradox of richness: A cognitive model of Media*
- Sivalingam, G. (2007). *Beach Based Recreation and Tourism in Malaysia*. Institute on Global Conflict and Cooperation (IGCC) database university of California.  
[sivalingam/](https://www.igcc.ucla.edu/sivalingam/)
- Smith, M. K. *Issues in cultural tourism studies*. Google Books. Retrieved January 4, 2023, from [https://books.google.com/books/about/Issues\\_in\\_Cultural\\_Tourism\\_Studies.html?i](https://books.google.com/books/about/Issues_in_Cultural_Tourism_Studies.html?i)
- [Sotonade/publication/361813544\\_BASIC\\_OF\\_EDUCATION\\_THE\\_MEANING](https://www.soton.ac.uk/publication/361813544_BASIC_OF_EDUCATION_THE_MEANING)  
[Sotonade/publication/361813544\\_BASIC\\_OF\\_EDUCATION\\_THE\\_MEANING](https://www.soton.ac.uk/publication/361813544_BASIC_OF_EDUCATION_THE_MEANING)
- Sumethokula, P., Patwary, A. K., Srinuanpanc, B., Srinuanpand, C., Suwandee, P., Thammathikul, A., & Phanong, W. (2020). The potential of new tour repackaging for creative tourism among entrepreneurs in Nakhon Si Thammarat. *International Journal of Innovation, Creativity and Change*, 13(10), 1752-1771.
- Tang, C., & Tan, E. (2015). *Does tourism effectively stimulate Malaysia's economic growth?* *Tourism Management*, 46, 158-163.  
<http://dx.doi.org/10.1016/.tourman.2014.06.020>.
- The Travel and Tourism Competitiveness Report (2013)*. World Economic Forum.  
[the-experience-economy](https://www.weforum.org/reports/the-experience-economy)  
[thematic-analysis-in-psychology.pdf](https://www.weforum.org/reports/the-experience-economy)
- Thorne, S. (2000). *Data Analysis in qualitative research*. Evidence-Based Nursing.  
[ting\\_Implications\\_for\\_targeting\\_the\\_senior\\_tourists'\\_segment.html](https://www.evidencebasednursing.com/implications-for-targeting-the-senior-tourists-segment.html)
- Tourism Malaysia Corporate Site. (n.d.). Retrieved January 17, 2023, from [https://www.tourism.gov.my/media/view/malaysia-stays-competitive-as-a-tourism-competitiveness-report-2013\\_u\\_id=L0pheU43NWJwRWVSZkIWdzQ4TIhUUT09](https://www.tourism.gov.my/media/view/malaysia-stays-competitive-as-a-tourism-competitiveness-report-2013_u_id=L0pheU43NWJwRWVSZkIWdzQ4TIhUUT09)
- Unesco (1970), UNESCO Office Nairobi UNESCO, & UNESCO Office in Beirut UNESCO. (1970, January 1). Youth. UNESCO.org. Retrieved January 8, 2023, from <https://www.unesco.org/en/youth>  
[value-for-money-destination-in-global-tourism-industry-2009](https://www.unesco.org/en/youth)
- Wilkinson, S., Joffe, H., & Yardley, L. (2004) *Qualitative data collection: Interviews and focus groups*. Semantic Scholar. Retrieved January 17, 2023, from <https://www.semanticscholar.org/paper/Qualitative-data-collection%3A->



- Wong, S. (2009) *News & media. MALAYSIA STAYS COMPETITIVE AS A VALUE-FOR-MONEY DESTINATION IN GLOBAL TOURISM INDUSTRY 2009 -*
- World economic forum - home. (2013). Retrieved January 17, 2023, from [http://www3.weforum.org/docs/WEF\\_TT\\_Competitiveness\\_Report\\_2013.pdf](http://www3.weforum.org/docs/WEF_TT_Competitiveness_Report_2013.pdf) Accessed:8-01- 2023.
- World Economic Forum (2013) The Travel & Tourism Competitiveness Report 2013 [http://www3.weforum.org/docs/WEF\\_TT\\_Competitiveness\\_Report\\_2013.pdf](http://www3.weforum.org/docs/WEF_TT_Competitiveness_Report_2013.pdf)
- Wu, B., Liu, S., Wang, J., Tahir, S., & Patwary, A. K. (2021). Assessing the mechanism of energy efficiency and energy poverty alleviation based on environmental regulation policy measures. *Environmental Science and Pollution Research*, 28, 40858-40870.
- Wu, B., Zhai, B., Mu, H., Peng, X., Wang, C., & Patwary, A. K. (2021). Evaluating an economic application of renewable generated hydrogen: A way forward for green economic performance and policy measures. *Environmental Science and Pollution Research*, 1-15.
- Youthtourism blogger (2012) . *youthtourism*. Retrieved January 17, 2023, from <https://youthtourism.wordpress.com/author/youthtourismblogger/>



# EXAMINING THE PERCEPTIONS OF TOURISM EMPLOYEES TOWARDS GOVERNMENT POLICIES FOR COVID-19 RECOVERY PROCESS

*Chuah Shan Wen, Ellyana Stephanie Anak Galang, Esther Anak Morrison & Fahim Ahmad  
Bin Ismail*

*Faculty of Hospitality, Tourism and Wellness, University Malaysia Kelantan  
Corresponding email: [h20a1123@siswa.umk.edu.my](mailto:h20a1123@siswa.umk.edu.my) [h20a1128@siswa.umk.edu.my](mailto:h20a1128@siswa.umk.edu.my)  
[h20a1129@siswa.umk.edu.my](mailto:h20a1129@siswa.umk.edu.my) [h20a1134@siswa.umk.edu.my](mailto:h20a1134@siswa.umk.edu.my)*

---

## ABSTRACT

This study examines the perceptions of tourism employees in the state of Kelantan towards government policies for the COVID-19 recovery process. To obtain the best results in this study, the researchers stated two objectives: (i) To identify the government's policies regarding rebuilding the tourism industry post-COVID-19 and (ii) To examine the government's plans to promote digital transition in the tourism industry post-COVID-19. The researchers employed an in-depth interview technique with travel agency employees in Kota Bharu, Kelantan. This qualitative data collection method involved interviews with pre-set questions to gain rich data. As a result, the findings of this qualitative study highlight several main themes emerging from tourism staff's perception of government policies for the recovery process of COVID-19, including participants expressing mixed views, the significance of clear communication and direction, and concerns about the long-term sustainability of government assistance.

---

**Keywords:** COVID-19, government policies, tourism employee, travel agency

---

## **INTRODUCTION**

Tourism has been one of the industries with the fastest economic growth due to factors that have an impact, such as sustainable economic growth, air transport liberalization, and regional cooperation. Next is the problem statement COVID-19 has significantly impacted many industries, but tourism and hospitality have been among the hardest hit globally. This research study aims to identify government policies regarding rebuilding the tourism industry after post-COVID-19 and examine the government's plans to promote digitalization in the tourism industry.

## **SIGNIFICANCE OF THE STUDY**

Tourism is a cultural where people visit other nations or places outside their typical environment for personal enjoyment or business purposes. According to one the data we have gathered, the tourism industry was believed to be a vital point for many economies worldwide to have had success. Tourism has the potential to increase the economy's earnings and offers thousands of job opportunities, helping to develop the infrastructure of a country and exchanging culture between foreigners and citizens (Yehia, 2019). However, the tourism and hospitality industry has been severely affected worldwide due to COVID-19, which has had a significant impact.

## **LITERATURE REVIEW**

Tourism is both a cultural and economic phenomenon. It involves people traveling to a place or country outside their usual environment for personal or business purposes. As customer satisfaction, safety, and enjoyment are especially important in tourism, tourism is a dynamic and competitive industry that must constantly adapt to changing customer needs and desires. The tourism industry has changed due to COVID-19. According to Dictionary (2022), Coronavirus disease 2019 is a possibly deadly coronavirus-related respiratory illness marked by fever, coughing, and shortness of breath. The industry is in disarray due to the COVID-19 pandemic, so the government needs to rebuild the tourism industry. Rethinking the future of tourism is a chance presented by the crisis. Policies implemented today will affect tourism in the future as the industry is at a crossroads. Governments must capitalize on digitalization, support the low-carbon transition, and promote the structural transformation necessary to create a stronger, more sustainable, and resilient tourism industry while considering the crisis's long-term effects. At the same time can help all travel agencies to increase business because they provide travel and travel-related services to the public on behalf of the accommodation or travel suppliers, offering different travel packages for each destination.

## **METHODOLOGY**

### **Research Design and Strategy**

A research design typically specifies how the information will be gathered, what tools will be used, how they will be used, and how the information will be interpreted. According to Creswell (2014), research design constitutes types of investigations using quantitative, qualitative, and mixed methods that allow for specific procedures targeting. However, in this research, the researcher only focused on qualitative methods for the data collection in this study.

Quantitative research is the procedure of gathering and analyzing numerical data. Current research design distinguishes three types such as descriptive, exploratory, and casual. Government policies response to COVID-19: Perception of travel agencies' employees will employ exploratory research. Exploratory research is defined as research done to investigate an ambiguous question. It is done to learn more about current issues but does not produce concrete outcomes. When conducting such investigations, researchers start with a broad idea and use the study to pinpoint problems that might be the subject of further investigation.

### **Sampling Strategy**

Sampling is a technique used to select individuals or subgroups of a population to make statistical inferences and estimate population characteristics. In this study, the researchers chose snowball sampling. A non-probability sampling technique called snowball sampling can increase the sample size by persuading additional cases to participate in the study. When subjects are difficult to locate, researchers use snowball sampling. In such instances, researchers use the snowball technique to track numerous categories to interview and gather data. Researchers utilize this sampling strategy when the subject is highly sensitive and cannot be discussed openly (Fleetwood, 2018). Surveys, for example, can be used to gather policy information. Many governments are unlikely to respond to the questions. To learn more about the policies, researchers still can approach persons they know or volunteers involved in the cause.

### **Data Collection Method**

The first step is to clearly define the target population. Next is, to select a sampling frame. The list of actual cases from which the sample will be taken is called the sampling frame. The sampling frame should reflect the population. The last step is, to choose a sampling technique. It is important to understand what sampling entails and the rationales behind why researchers are likely to choose a sample before examining the various sampling techniques. Non-

probability that is used in this study is snowball sampling. Defining a clear target population is the first step in the sampling process. In this study, the unit of study is a travel agency. We have to conduct face-to-face interviews, which is a cost-effective way to quickly obtain a significant volume of data gathered quickly from a large number of people. We need to spend time finding interviewees and conducting interviews. Data was collected via interviewing 3 different travel agencies' employees in the Kota Bharu area.

## **FINDINGS**

The findings of this qualitative study highlighted several key terms that emerged from the perceptions of tourism employees toward government policies for the COVID-19 recovery process. Firstly, participants expressed mixed views regarding the effectiveness of government policies. Respondent stated that travel agencies did not conduct internet commerce or work from home during the pandemic. Instead, they paused operations until authorities permitted them to resume operations. The government helped by paying half of the employees' salaries and providing financial aid of RM3000 to keep the travel businesses operational. At the same time, the other respondents said, "During the pandemic, travel agencies are not closed and are usually online, so the company will promote working from home through social media, which as Instagram and WhatsApp. Next is the significance of clear communication and direction, which is the importance of timely and transparent communication. Third, employees expressed concerns about the long-term sustainability of government assistance. The respondent said, "This country's tourism blueprint needs to be changed by me. Because he doesn't support it. Not supporting entrepreneurs in tourism". The findings can be used by policymakers and industry stakeholders to improve policy formulation and implementation, ensuring that they address the concerns and needs of tourist employees.

## **DISCUSSION AND RECOMMENDATION**

The previous study because it provides essential information regarding tourism employees' perceptions of government policies related to the COVID-19 recovery process. With this information as a guide, the present research further explores the perceptions of those same employees more precisely and sees if any additional factors, such as socioeconomic or cultural differences, play a role in how they perceive the policies resulting from research questions and research objectives.

A limitation is an act of something with limitations, such as a period. In conducting this research study, researchers have faced limitations such as limited time and limited respondents, and limited access to information. Researchers experience time constraints in getting feedback

from respondents because they have yet to answer the call or reply to our email after all the information or details were given to them. Some of the targeted respondents did not answer the phone call or respond through email, which caused researchers to waste their time making a phone call to replace and find another respondent. The researcher's targeted respondents are only owners and travel agency employees in Kota Bharu.

The first recommendation or suggestion is that the government should incentivize all travel agencies to revive the tourism industry. The government will extend the tax exemption for inbound tourism players in the upcoming budget. Other than that, the digital transition of the tourism industry can also be identified in the selection of smartphones as the tool of choice for tourists who want to go on vacation.

## **CONCLUSION**

This study concludes that the government should take serious action to enforce effective policies to recover Malaysia from the Covid-19 condition. This is because the tourism industry is also a major contributor to the national economy.

## REFERENCES

- Akter, M., Sadekin, M. N., & Patwary, A. K. (2020). An Empirical Study on Students' Satisfaction from Mawlana Bhashani Science & Technology University, Bangladesh. *Review of Economics and Development Studies*, 6(2), 363-379.
- Alom, S., Patwary, A. K., & Khan, M. M. H. (2019). Factors affecting the turnover intention of Bangladeshi migrants in the United Arab Emirates: An empirical study on the hotel industry. *International Journal of Innovation, Creativity and Change*, 8(3), 344-360.
- Creswell (2014). *Research Design*. Retrieved from <https://eprints.umm.ac.id/73306/4/CHAPTER%20III.pdf>
- Dictionary. (2022). *COVID-19*. Retrieved 27 November 2022 from <https://www.dictionary.com/browse/covid-19>
- Fengmin, Z., Baijun, W., Jiangtao, B., Li, L., & Patwary, A. K. (2022). Investigating revisit intention of medical tourists in China through nutritional knowledge, perceived medical quality, and trust in the physician: A recommendation on health tourism policy measures. *Frontiers in Public Health*, 10, 893497.
- Fleetwood, D. (2018, April 9). *Types of sampling: Sampling methods with examples*.
- Hazbar, A. M. H., Alem Mohammed, A., & Karim, A. K. A. (2019). An Empirical Study of Factors Influencing hotel customers' online booking Intention. *مجلة العلوم التربوية و الدراسات الإنسانية*, 5(5), 1-17.
- Li, L., Ragavan, N. A., Patwary, A. K., & Baijun, W. (2022). Measuring patients' satisfaction toward health tourism in Malaysia through hospital environment, nutritional advice, and perceived value: A study on Chinese exchange students. *Frontiers in public health*, 10, 893439.
- Li, L., Wu, B., & Patwary, A. K. (2022). How marine tourism promote financial development in sustainable economy: new evidences from South Asia and implications to future tourism students. *Environmental Science and Pollution Research*, 29, 1155-1172.
- Li, L., Wu, B., & Patwary, A. K. (2022). The psychosocial factors affecting chinese Outbound Exchange and mobility students' academic performance during COVID-19. *Frontiers in psychology*, 13, 872516.
- Patwary, A. K., Roy, B., Hoque, R., & Khandakar, M. S. A. (2019). Process of developing a community based tourism and identifying its economic and social impacts: An Empirical study on Cox's Bazar, Bangladesh. *Pakistan Journal of Humanities and Social Sciences*, 7(1), 1-13.
- QuestionPro*. Retrieved January 1, 2023, from <https://www.questionpro.com/blog/types-of-sampling-for-social-research/>
- Sumethokula, P., Patwary, A. K., Srinuanpanc, B., Srinuanpand, C., Suwandee, P., Thammathikul, A., & Phanong, W. (2020). The potential of new tour repackaging for creative tourism among entrepreneurs in Nakhon Si Thammarat. *International Journal of Innovation, Creativity and Change*, 13(10), 1752-1771.
- Wu, B., Liu, S., Wang, J., Tahir, S., & Patwary, A. K. (2021). Assessing the mechanism of energy efficiency and energy poverty alleviation based on environmental regulation policy measures. *Environmental Science and Pollution Research*, 28, 40858-40870.
- Wu, B., Zhai, B., Mu, H., Peng, X., Wang, C., & Patwary, A. K. (2021). Evaluating an economic application of renewable generated hydrogen: A way forward for green economic performance and policy measures. *Environmental Science and Pollution Research*, 1-15.
- Yehia, Y. (26 March 2019). The Importance of Tourism on Economies and Businesses, Retrieved 26 November 2022 from <https://globaledge.msu.edu/blog/post/55748/the-importance-of-tourism-on-economies-a>

**THE FACTORS DETERMINE FOOD SATISFACTION AMONG  
DOMESTIC TOURISTS:  
THE CASE OF GASTRONOMIC TOURISM  
IN KELANTAN**

*Fikri Hakim Zaini, Haslinda Mohd Ariffin, Hadzleen Nur Syarfaqila Hamden, Haniff  
Safwan Razali & Muhamad Nasyat Muhamad Nasir\**

*Faculty of Hospitality, Tourism and Wellness, University Malaysia Kelantan  
Corresponding email: [nasyat.mn@umk.edu.my](mailto:nasyat.mn@umk.edu.my)*

---

**ABSTRACT**

Measuring food satisfaction among tourists has become more crucial since the gastronomic tourism sector involves travellers' desire to have authentic and unique eating experiences, which is presently a growing trend in the tourism business. As one of Malaysia's most well-known destinations for food tourism, Kelantan was chosen for the study. The purpose of this study is to identify the variables: food related motivation, involvement, perceived value, influencing satisfaction among domestic visitors visiting the state of Kelantan for culinary tourism. This study used a quantitative survey using questionnaires which were distributed among domestic tourists who have experienced tasting local foods in Kelantan. A total of 200 respondents participated to answer all questions in this survey and it was found that food related motivation, involvement, perceived value has effects on food satisfaction. Stakeholders such as the state government and businesses must continue to make efforts to create more appealing local food in order to make tourist destinations more attractive.

**Keywords: Food-related Motivation, Local Food Involvement, Food Satisfaction, Perceived Value, Gastronomic Tourism**

---

## INTRODUCTION

Globally, tourism is one of the largest service industries in the world and the main source of income for the nation's economic expansion. According to the United Nations World Travel Organization (UNWTO), gastronomy tourism is a tourist activity that is defined by the visitor's experience associated with food and related products while travelling. Malaysian culture and lifestyle place a high value on food. As a result, there are many foods that are sold not only in restaurants but also many that are sold at the stalls on the sides of the road.

One of the states in Malaysia that is well-known for its food and local delicacies is Kelantan. The cost of living in Kelantan is quite low as compared to other states, which might indirectly satisfy tourists who eat food in this state. As a result, food in Kelantan can be described as delicious and cheap. However, in Kelantan, 1,079 incidents of food poisoning have been reported in all registered food facilities, including canteens and kitchens of school dormitories and higher education institutions (*17 Premis Makanan Kotor di Kelantan Diarah Tutup*, 2022). Additionally, there are street sellers who sell unhygienic food, and the standard of sanitation is very dubious (*17 Premis Makanan Kotor di Kelantan Diarah Tutup*, 2022). However, gastronomic tourism in Kelantan must be sustained at the highest quality. Ji et al. (2016) claims the use of food as a travel motive may affect their food preferences, which may result in satisfaction when they make the right choice. If these factors may increase satisfaction, more tourists will arrive since loyal visitors will come back and recommend the destination to others. Following that, it will promote the purchase of meals by domestic visitors to the state, increasing revenue for the state. Thus, this study is to identify the main factors that determine the food satisfaction among domestic tourists who consume local food in Kelantan. Several objectives of this study were established as follows:

1. To determine the relationship between local food involvement and food satisfaction in Kelantan.
2. To determine the relationship between perceived value and food satisfaction in Kelantan.
3. To determine the relationship between food-related motivation and food satisfaction in Kelantan.



## **Significance of The Study**

### **1. Domestic Tourists (Demand Side)**

The desire of visitors to enjoy original and distinctive eating experiences is only beginning to take off in the tourism sector (Smith & Costello, 2009). In the end, travellers that engage in and enjoy are satisfied with local cuisine in Kelantan will have unique travel experiences since local cuisine is strongly associated with regional cultures and history, which may result in lifelong memories (Tsai, 2016). This study will provide piece of valuable information to make them happy and enjoy when tasting and experiencing local foods in Kelantan.

### **2. Small and Medium Enterprise (Supply Side)**

Small and Medium Enterprise (SME) is an important entity to provide information to determine food satisfaction among domestic tourists visiting Kelantan. It can be related to how far the food can fulfil the needs and expectations from customers. Lack of information causes a customer's perception of the food to differ from what is actually there. In addition, they must take into consideration making food that meets the standards expected by their customers. It will be evaluated in terms of quality through customization. How far the food can satisfy a customer completely. The quality of the food that a business offers to its customer can be seen from the perspective of the small and medium enterprise.

### **3. Sustainable Development Goals (SDGs)**

Stability between environmental, economic, and socio-political sustainability can be achieved through sustainable development strategies. In order to create continuity between economic, social, and environmental growth for the purpose of a common peace without sacrificing the needs of future generations, sustainable development goals must meet both the demands of the present and the future. Sustainable development has 17 important goals in the concept of sustainable development goals. Based on goal number 1 and 2 is about no poverty and zero hunger. Furthermore, goal number 8, it aims to promote sustainable, inclusive and sustainable economic growth, full and productive employment and good work for all good work and economic growth. Hence, by improving the level of tourist satisfaction visiting Kelantan, they tend to purchase more food in Kelantan and the businesses will receive more income. It will provide more jobs to people. It will make them have stable jobs to feed their families and eradicate poverty among the people. This will stimulate economic growth. Therefore, it will achieve goals 1, 2 and 8.

## **LITERATURE REVIEW**

### **Local Food Involvement**

Involvement in the tourism industry has been used to gauge tourist experience (Green and Chalip, 1998; Laverie and Amett, 2000). Many national and local groups, such as the Green Restaurant Association (GRA), describe local food as being within a 100-mile radius of a business, but "regional" food can be defined as being within a 300-mile radius (Green Restaurant Association, 2012). The research claims that engagement is a type of attitude that manifests itself when a person engages with their social surroundings. In varying degrees, loyalty and satisfaction have an impact on involvement. The phrase "local food involvement" refers to the extent to which customers participate in a destination's food-related activities based on these relevant research and literature. The authors discovered that tourists' interest in local cuisine in China has little to do with their commitment to a particular location (Chen & Huang, 2018). Most importantly, involvement has a significant impact on tourist satisfaction (Biswas, Deb, Hasan, and Khandakar, 2021).

## **Perceived Value**

Most tourism sites will require attractions that can draw visitors to the area. To accomplish this, it is necessary to bet on an original and creative gastronomic offer capable of attracting and retaining tourists motivated by culinary pleasures (Gonzalez Santa Cruz, Moral Cuadra, Choque Tito, Lopez-Guzman, 2020). It is also vital to gamble on the destination's gastronomic diversification, so that not all of its tourist attractions are concentrated around a single attraction. The gastronomic experience must be linked to other relevant activities that increase the perceived value of the tourist experience, such as wine tourism or oil tourism (Haven-Tang and Jones, 2005). All of this is possible provided the destination's public and private players allow and support the development of great restaurants, culinary routes, museums and interpretive centres, adequate infrastructure, and food markets (Dimitrovski, Crespi Vallbona, 2017). However, this must be supplemented by an adequate advertising plan in the issuing or potential markets, such as participation in specialised fairs (Ignatov and Smith, 2006). Moreover, Yuliantoro et al. (2019), claimed that perceived value has a significant impact on tourist satisfaction.

## **Food-related Motivation**

Consumers' choices in food may reflect a variety of motives. According to prior study, affordability, convenience, healthiness, and sensory appeal are often the four most crucial criteria that determine what people choose to eat (Scheibehenne., Miester., and Todd., 2007). The word "motivation" refers to the reasons behind someone's actions. It is what motivates people to act in the way they do. The mechanism that starts, directs, and sustains goal-oriented activities is known as motivation (Cherry., 2022).

There are many different types of motivation that are effective in diverse situations, but they all have three characteristics, activation, persistence, and intensity, which may increase motivation in general. Most importantly, motivation influences tourist satisfaction (Bayih, & Singh, 2020).

## **Food Satisfaction**

Food satisfaction is defined as "a good physical and psychological response after taking food and is linked to reported stomach emotions, energy levels, and a longer satiety period following consumption (Anderson and Hyldig, 2015; Lawless and Heymann, 2010). Additionally, vacationers' favourite feeling after exploring a tourist location is culinary pleasure. Satisfaction may be made up of two components. Chemical or emotional factors may be

involved, such as having adequate carbohydrates, protein, and fat. When assessing if we believe we have received what we need, factors including taste, texture, warmth, ambient experience, numbing of emotions, celebrations, social connections, and culture are taken into account (Rebecca Panzer Toutant, 2018). In other words, it is considered satisfactory when tourists' perceptions exceed their initial expectations. Food satisfaction can be measured using general satisfaction attributes such as "taste, appearance, good smell, availability of food, and environment". It is crucial to distinguish between overall contentment and happiness with various aspects of tourism since the distinctive quality of tourism has a significant influence on visitors' satisfaction with meals (Seaton & Benett, 1996; Boonsiritomachai, 2017). Tourists' satisfaction with food (food satisfaction) is important for the success of tourism destination marketing. It influences the decision to visit a certain area, the purchase of tourism-related products and services, and also the desire to go there again (Yoon & Uysal, 2005).

### Research Hypothesis

- H1: There is a significant relationship between local food involvement and food satisfaction.
- H2: There is a significant relationship between perceived value and food satisfaction.
- H3: There is a significant relationship between food related motivation and food satisfaction.

### Research Framework

Figure 1 shows the research framework used in this study.

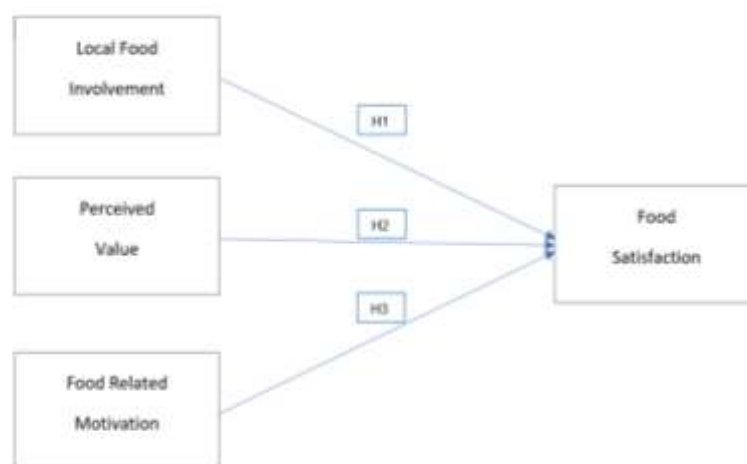

**Figure 1: Research Framework**

## **METHODOLOGY**

### **Research Design**

According to Creswell & Creswell (2017), a study strategy, structure, and method known as research design. This study employed a quantitative approach. Three forms of study are distinguished by this design: causal, exploratory, and descriptive. This investigation employed causal analysis. Cross-sectional design has been used in this investigation. A cross-sectional investigation is a type of research design in which information is concurrently obtained from several people. Individual visitors, more particularly, domestic tourists who eat local cuisine in Kelantan are the study's unit of analysis.

### **Data Collection**

The data collection method procedure is the compilation of data from respondents. When collecting data for this study, a questionnaire survey was used using google form. Respondents are required to answer a series of questions from the distributed questionnaire.

### **Sampling**

Sampling is a statistical analysis technique in which a certain number of samples are selected from a large population or a sample survey (Poonam, 2022). Depending on the sort of study being undertaken, there are two types of sampling methods which are probability sampling and non-probability sampling. In this study, a non-probability sampling technique has been used. A convenience sampling strategy has been adopted in this study because it is simple to use and low cost.

### **Data Analysis**

A method of assessing and understanding the information gathered from the respondents is data analysis.

### **Statistical Package for the Social Sciences (SPSS)**

A statistical analysis application that has been used is SPSS. It is the most commonly used statistical tool, it is capable of evaluating and processing complex data using simple methods. SPSS is used to analyse various sorts of data. Frequency analysis, descriptive statistics and reliability analysis were used to analyse the data. Frequency analysis is used to determine the number of respondents who answer the questionnaire based on certain criteria. Descriptive analysis is used to summarise and characterised the data (Zikmund et al., 2013; Creswell & Creswell, 2017). Descriptive statistics were

generated in this study for each of the dependent and independent variable. To make the data easier to grasp, it uses metrics such as mean, and standard deviation. The reliability analysis whereby it is used to measure the internal consistency of items used to measure the variables. A straightforward metric for evaluating reliability is Cronbach's alpha. Values of true Cronbach's alpha of 0.70 and beyond are taken into consideration. The ideal score is 0.8 or higher, while an outstanding score is 0.90 or higher. Lastly, The Pearson correlation coefficient was used to analyse the data that had been obtained. It is used to evaluate the impact of the straight connection between the independent variables (IV) and the dependent variable. The Pearson correlation coefficient assesses the strength of a two-variable linear relationship. It has a value ranging from -1 to 1, with -1 indicating total negative linear correlation, 0 indicating no connection, and + 1 indicating total positive correlation. The correlation, like the Pearson correlation, assesses the strength of a monotonic relationship between two variables (Bonett & Wright, 2000).

## FINDINGS

### Profile of Respondents

<b>Demographic</b>	<b>Categories</b>	<b>Frequency (N)</b>	<b>Percentage (%)</b>
<b>Age</b>	18 - 20 years	10	5.0
	21 - 30 years	151	75.5
	31 - 40 years	10	5.0
	41 - 50 years	12	6.0
	51 years and above	17	8.5
<b>Gender</b>	Male	53	26.5
	Female	147	73.5
<b>Race</b>	Malay	188	94.0
	Indian	1	0.5
	Chinese	0	0
	Others	11	5.5
<b>Travel Frequencies in a year</b>	1-2 times	107	53.5
	3-5 times	50	25.0
	More than 5 times	42	21.0

Demographic	Categories	Frequency (N)	Percentage (%)
<b>Travel Period</b>	Public holiday	24	12.0
	School holiday	46	23.0
	Semester breaks	49	24.5
	Anytime	79	39.5
	Other	2	1.0

**Table 1: Respondent Profile**

Table 1 shows profiles of 200 respondents and most of them are at the age of 21-30 years old which is (75.5%) from the total of the sample. The lowest frequency respondents' age is 18-20 with (5%). The majority of the respondents are female, (73.5%), compared to male (26.5%). Meanwhile for race, the highest respondents are Malay with (94%). The race of Chinese has the lowest frequency since none of them responded to the questionnaires. As for the travel frequencies, (53.5%) of people travel 1-2 times and (21%) is the lowest frequency of the respondents that travel more than 5 times. In terms of travel period, people who travel anytime are the highest percentage with (39.5%) and the lowest are others with (1%). Thus, the data accurately reflect the real demographic compilation of the determine food satisfaction among domestic tourists visiting Kelantan, Malaysia.

**Analysis for The Determinant of Food Satisfaction Among Domestic Visitors: The Case of Gastronomic Tourism in Kelantan**



<b>Variable</b>	<b>Items</b>	<b>N</b>	<b>Mean</b>	<b>Standard Deviation</b>
Local Food Involvement	Food plays an important role in choosing the destination to visit.	200	4.29	0.727
	Prior to my trip, I planned food choices to experience local culture	200	3.95	0.858
	I decided on destinations to visit only based on the foods I wanted to experience	200	3.75	0.944
	I usually do some research about the local food or restaurants prior to my trip	200	3.91	0.830
	Prior to my trip, one thing I anticipate is eating the food there	200	4.12	0.818
	I like trying different styles or types of food during travel.	200	4.25	0.777
Perceived Value	Local Food Involvement is Interesting	200	4.22	0.694
	Local Food Involvement is Appealing	200	4.12	0.761

	Local Food Involvement is Valuable	200	4.13	0.736
	Local Food Involvement is Exciting	200	4.12	0.793
	Local Food Involvement is Desirable	200	4.17	0.737
	Local Food Involvement is Wanted	200	4.10	0.754
	Local Food Involvement Mean a lot	200	4.13	0.816
Food Related Motivation	I obtained good results from consuming food while visiting Kelantan	200	4.02	0.811
	Food in Kelantan makes it as a destination that I enjoy	200	4.01	0.891
	Consuming food in Kelantan gave me pleasure	200	4.04	0.858
	Compared to other tourism destinations, purchasing food in Kelantan is good value for money	200	4.05	0.881

	Compared to food expenses, I got reasonable quality food experience from visiting Kelantan	200	3.99	0.885
Food Satisfaction	The food experience in Kelantan gave me high satisfaction	200	3.98	0.894
	My choice to taste the local cuisine was a wise one	200	4.06	0.815
	The food experience in Kelantan gave me a sense of joy	200	4.05	0.846
	The food experienced in Kelantan met my expectations	200	3.89	0.918
	The food I experienced in Kelantan exceeded my expectations	200	3.86	0.965

**Table 2: Descriptive Analysis for The Determinant of Food Satisfaction Among Domestic Visitors: The Case of Gastronomic Tourism in Kelantan.**

Table 2 shows the mean and standard deviation of dependent variable and independent variable in this study. The highest mean value in dependent variable was obtained by Question 2 with 4.06 (SD= 0.815) where the respondents agreed that “choosing to taste local cuisine was a wise one”. Meanwhile, Question 5 has a lowest mean value with 3.86 (SD= 0.965) which means the respondents agreed that “food experience in Kelantan exceeds their expectations”. Independent variables for local food involvement had a highest mean value that belongs to Question 1 4.29 (SD= 0.727) which meant that the respondents agreed “food plays an important role in choosing the destination to visit”. After that, the lowest mean value was obtained by Question 3 with 3.75 (SD= 0.944) where the respondents agreed that “destinations to visit only based on the foods they want to experience”. Question 1 had the highest mean value for the independent variable of perceived value, with 4.22 (SD= 0.694), indicating that respondents admit that “local food involvement is interesting”. Question 6 has the lowest mean of 4.10 (SD= 0.754) meaning that respondents concede that “local food involvement is wanted”. The highest mean value for independent variable motivation is Question 4 with 4.05 (SD=0.881), meaning that respondents comply with the statement that purchasing food in Kelantan “is good value for money”. While the lowest mean for the motivation is Question 5 with 3.99 (SD=0.885) showing that respondents agreed that “it is a reasonable quality food experience from visiting Kelantan”.

**Relationship between Local Food Involvement, Perceived Value, Food-Related Motivation among domestic tourists visiting Kelantan, Malaysia.**

		<b>Tourist Satisfaction using AirAsia as a preferred Airline to travel to the domestic destination</b>	
<b>Local Food Involvement</b>	Pearson Correlation		.928
	Sig. (2-tailed)		.000
	N		200
<b>Perceived Value</b>	Pearson Correlation		.752
	Sig. (2-tailed)		.000
	N		200
<b>Food-Related Motivation</b>	Pearson Correlation		.628
	Sig. (2-tailed)		.000
	N		200

**Table 3: Pearson's Correlation between Local Food Involvement, Perceived Value , Food-Related Motivation among domestic tourists visiting Kelantan.**

The result in Table 3 indicates that local food involvement and food satisfaction among domestic tourists visiting Kelantan with 0.928 indicated strong positive correlation. Next is perceived value and food satisfaction among domestic tourists visiting Kelantan showed 0.752 indicating strong positive correlation. Following food-related motivation and food satisfaction among domestic tourists visiting Kelantan shows 0.628 indicated medium positive correlation. Therefore, all the three variables positively correlated with food satisfaction among domestic tourists visiting Kelantan ( $p < 0.05$ ).

**H1:** There is a significant relationship between local food involvement and food satisfaction among domestic tourists visiting Kelantan, Malaysia.

The finding of this study is consistent with the study by Biswas, Deb, Hasan, and Khandakar (2021) whereby involvement is an important predictor of tourist satisfaction. Hence, H1 is supported.

**H2:** There is a significant relationship between perceived value and food satisfaction among domestic tourists visiting Kelantan, Malaysia.

The outcome of this study is consistent with the finding of previous study whereby perceived value has a positive relationship with satisfaction (Yuliantoro et al., 2019). Thus, H2 is supported.

**H3:** There is a significant relationship between food related motivation and food satisfaction among domestic tourists visiting Kelantan, Malaysia.

The study found that food related motivation is positively correlated with food satisfaction. This finding is supported by Bayih and Singh (2020). Hence, H3 is supported.

## **DISCUSSION AND RECOMMENDATION**

Kelantan is a popular tourist destination, with a high number of domestic visitors. To sustain Kelantan's reputation as an attractive tourist destination, the Malaysian tourism industry's management must comprehend their needs and wants. One of the important tourism products in Kelantan is food. Tourism management in Kelantan should promote the local cuisine throughout Malaysia and let them get involved in selecting and purchasing local foods when they visit Kelantan. Moreover, the food stalls and restaurants should provide a variety of local food so that they are more motivated to visit Kelantan. This will help to generate income and encourage the growth of the state's economic development.

The current study has a significant weakness that needs to be improvised such as a limited time for data collection. Therefore, only 200 respondents responded to questionnaires which is less than the earlier total number of samples that the study expected. The researchers made every attempt to contact respondents as soon as possible. Things that may be changed or improved for future studies is that researchers can further diversify the data collection methods such as collecting data online and offline.

## **CONCLUSION**

In conclusion, this study has achieved its main objective which is to discover the factors that determine the food satisfaction among domestic visitors that visit Kelantan. A total of 200 respondents from the age of 18 years old and above were selected from all states of Malaysia who had experience tasting local foods in Kelantan to determine food satisfaction using questionnaire surveys. As a result, three independent variables: food related motivation, local food involvement and perceived value have a significant relationship with food satisfaction among domestic tourists who have tasted local cuisine in Kelantan.

## REFERENCES

- Akter, M., Sadekin, M. N., & Patwary, A. K. (2020). An Empirical Study on Students' Satisfaction from Mawlana Bhashani Science & Technology University, Bangladesh. *Review of Economics and Development Studies*, 6(2), 363-379.
- Alom, S., Patwary, A. K., & Khan, M. M. H. (2019). Factors affecting the turnover intention of Bangladeshi migrants in the United Arab Emirates: An empirical study on the hotel industry. *International Journal of Innovation, Creativity and Change*, 8(3), 344-360.
- Bayih, B. E., & Singh, A. (2020). Modeling domestic tourism: motivations, satisfaction and tourist behavioral intentions. *Heliyon*, 6(9), 1-17.
- Biswas, C., Deb, S. K., Hasan, A. A. T., & Khandakar, M. S. A. (2021). Mediating effect of tourists' emotional involvement on the relationship between destination attributes and tourist satisfaction. *Journal of Hospitality and Tourism Insights*, 4(4), 490-510.
- Bonett, D. G., & Wright, T. A. (2000). Sample size requirements for estimating pearson, kendall and spearman correlations. *Psychometrika*, 65(1), 23–28. <https://doi.org/10.1007/bf02294183>
- BYJUS. Retrieved December 13, 2022, from <https://byjus.com/commerhttps://byjus.com/commerce/types-of-sampling->
- Campbell, J., DiPietro, R. B., & Remar, D. (2014). Local foods in a university setting: Price consciousness, product involvement, price/quality inference and consumer's willingness-to-pay. *International Journal of Hospitality Management*, 42, 39–49. <https://doi.org/10.1016/j.ijhm.2014.05.014>
- Chen, Q., & Huang, R. (2018). Understanding the role of local food in sustaining Chinesedestinations. *Current Issues in Tourism*, 22(5), 544–560. <https://doi.org/10.1080/13683500.2018.1444020>
- Cherry, K. (2022, May 23). *Motivation: Psychological factors that guide behavior*. Verywell Mind. <https://www.verywellmind.com/what-is-motivation-2795378>
- Creswell, J. D. (2017). Mindfulness interventions. *Annual Review of Psychology*, 68(1), 491–516. <https://doi.org/10.1146/annurev-psych-042716-051139>
- Dimitrovski, D., & Crespi Vallbona, M. (2017). Urban food markets in the context of a tourist attraction – La Boqueria market in Barcelona, Spain. *Tourism Geographies*, 20(3),
- Eku Online. (2021, September 30). What is Gastronomic Tourism? EKU Online. <https://ekuonline.eku.edu/blog/global-hospitality-blog/what-is-gastronomic-tourism/>
- Fengmin, Z., Baijun, W., Jiangtao, B., Li, L., & Patwary, A. K. (2022). Investigating revisit intention of medical tourists in China through nutritional knowledge, perceived medical quality, and trust in the physiologist: A recommendation on health tourism policy measures. *Frontiers in Public Health*, 10, 893497.
- González Santa Cruz, F., Moral-Cuadra, S., Choque Tito, J., & López-Guzmán, T. (2020). Gastronomic Motivations and Perceived Value of Foreign Tourists in the City of *Green Restaurant Association | Sustainability | Certification*. (n.d.). Green Restaurant. <https://www.dinegreen.com/>
- Haven-Tang, C., & Jones, E. (2005). Using Local Food and Drink to Differentiate Tourism Destinations Through a Sense of Place. *Journal of Culinary Science & Technology*, 4(4), 69–86. [https://doi.org/10.1300/j385v04n04\\_07](https://doi.org/10.1300/j385v04n04_07)



- Hazbar, A. M. H., Alem Mohammed, A., & Karim, A. K. A. (2019). An Empirical Study of Factors Influencing hotel customers' online booking Intention. *مجلة العلوم التربوية و الدراسات الإنسانية*, (5), 1-17.  
<https://doi.org/10.3390/ijerph17103618>
- Ignatov, E., & Smith, S. (2006). Segmenting Canadian Culinary Tourists. *Current Issues in Tourism*, 9(3), 235–255. <https://doi.org/10.2167/cit/229.0>
- Ji, M., Wong, I. A., Eves, A., & Scarles, C. (2016). Food-related personality traits and the moderating role of novelty-seeking in food satisfaction and travel outcomes. *Tourism Management*, 57, 387–396. <https://doi.org/10.1016/j.tourman.2016.06.003>
- Lacap, J. P. (2019). The Effects of Food-Related Motivation, Local Food Involvement, and Food Satisfaction on Destination Loyalty: The Case of Angeles City, Philippines. *Advances in Hospitality and Tourism Research (AHTR)*, 238–257. <https://doi.org/10.30519/ahtr.550600>.
- Li, L., Ragavan, N. A., Patwary, A. K., & Baijun, W. (2022). Measuring patients' satisfaction toward health tourism in Malaysia through hospital environment, nutritional advice, and perceived value: A study on Chinese exchange students. *Frontiers in public health*, 10, 893439.
- Li, L., Wu, B., & Patwary, A. K. (2022). How marine tourism promote financial development in sustainable economy: new evidences from South Asia and implications to future tourism students. *Environmental Science and Pollution Research*, 29, 1155-1172.
- Li, L., Wu, B., & Patwary, A. K. (2022). The psychosocial factors affecting chinese Outbound Exchange and mobility students' academic performance during COVID-19. *Frontiers in psychology*, 13, 872516.
- Oruro (Bolivia): An Analysis Based on Structural Equations. *International Journal of Environmental Research and Public Health*, 17(10), 3618.
- Patwary, A. K., Roy, B., Hoque, R., & Khandakar, M. S. A. (2019). Process of developing a community based tourism and identifying its economic and social impacts: An Empirical study on Cox's Bazar, Bangladesh. *Pakistan Journal of Humanities and Social Sciences*, 7(1), 1-13.
- Poonam. (n.d.). *Types of Sampling Methods | Random Sampling, Non-Random Sampling*.
- Safian, S. S. S., Osman, A. A., Wahab, S. N., Othman, N., & Mohammad Azhar, N. A. Z. (2021). The Effect of Culinary Tourism on Tourists' Loyalty and Satisfaction: A Comparison Analysis Between the First and Revisit to Malaysia. *International Journal of Academic Research in Business and Social Sciences*, 11(8). <https://doi.org/10.6007/ijarbss/v11-i8/10535>
- Scheibehenne, B., Miesler, L., & Todd, P. M. (2007). Fast and frugal food choices: Uncovering individual decision heuristics. *Appetite*, 49(3), 578–589. <https://doi.org/10.1016/j.appet.2007.03.224>
- Sinar Harian, *17 premis makanan kotor di Kelantan diarah tutup*. (2022, July 5). Sinar Harian. <https://www.sinarharian.com.my/article/210083/berita/semasa/17-premis-makanan-kotor-di-kelantan-diarah-tutup> 397– 417.  
<https://doi.org/10.1080/14616688.2017.1399438>

- Smith, S., & Costello, C. (2009). Segmenting Visitors to a Culinary Event: Motivations, Travel Behavior, and Expenditures. *Journal of Hospitality Marketing & Management*, 18(1), 44–67. <https://doi.org/10.1080/19368620801989022>
- Snelgrove, R., Taks, M., Chalip, L., & Green, B. C. (2008). How Visitors and Locals at a Sport Event Differ in Motives and Identity. *Journal of Sport & Tourism*, 13(3), 165–180. <https://doi.org/10.1080/14775080802310215>
- Sumethokula, P., Patwary, A. K., Srinuanpanc, B., Srinuanpand, C., Suwandee, P., Thammathikul, A., & Phanong, W. (2020). The potential of new tour repackaging for creative tourism among entrepreneurs in Nakhon Si Thammarat. *International Journal of Innovation, Creativity and Change*, 13(10), 1752-1771.
- United Nations. (n.d.). *Sustainable tourism | Department of Economic and Social Affairs*. Sdgs.un.org. <https://sdgs.un.org/topics/sustainable-tourism>
- Vad Andersen, B., & Hyldig, G. (2015). Food satisfaction: Integrating feelings before, during and after food intake. *Food Quality and Preference*, 43, 126–134. <https://doi.org/10.1016/j.foodqual.2015.03.004>
- Waranpong Boonsiritomachai, & Chanchai Phonthanukitithaworn. (2018). DESTINATION ATTRIBUTES THAT ATTRACT MARATHON RUNNERS: A CASE STUDY OF THE BANGSAEN21 HALF MARATHON. *Modern Management Journal*, 16(1), 251–262. <https://so04.tci-thaijo.org/index.php/stou-sms-pr/article/view/134552>
- Wu, B., Liu, S., Wang, J., Tahir, S., & Patwary, A. K. (2021). Assessing the mechanism of energy efficiency and energy poverty alleviation based on environmental regulation policy measures. *Environmental Science and Pollution Research*, 28, 40858-40870.
- Wu, B., Zhai, B., Mu, H., Peng, X., Wang, C., & Patwary, A. K. (2021). Evaluating an economic application of renewable generated hydrogen: A way forward for green economic performance and policy measures. *Environmental Science and Pollution Research*, 1-15.
- Yoon, Y., & Uysal, M. (2005). An examination of the effects of motivation and satisfaction on destination loyalty: a structural model. *Tourism Management*, 26(1), 45–56. <https://doi.org/10.1016/j.tourman.2003.08.016>
- Yuliantoro, N., Goeltom, V., Juliana, I. B., Pramono, R., & Purwanto, A. (2019). Repurchase intention and word of mouth factors in the millennial generation against various brands of Boba drinks during the Covid 19 pandemic. *African Journal of Hospitality, Tourism and Leisure*, 8(2), 1-11.
- Zhou, Y., & Siu, A. F. Y. (2015). Motivational intensity modulates the effects of positive emotions on set shifting after controlling physiological arousal. *Scandinavian Journal of Psychology*, 56(6), 613–621. <https://doi.org/10.1111/sjop.12247>

# THE FACTORS DETERMINE SATISFACTION AMONG TOURIST VISITING SUSTAINABLE HERITAGE TOURISM DEVELOPMENT IN KELANTAN

Khairul Azmi Murir, Iza Shahfika Ibrahim, Leong Hui Thin, Lim Shin Ying & \*Muhamad Nasyat Muhamad Nasir\*

*Faculty of Hospitality, Tourism and Wellness, Universiti Malaysia Kelantan*  
*Corresponding email: [nasyat.mn@umk.edu.my](mailto:nasyat.mn@umk.edu.my)*

---

## ABSTRACT

The study's main objective is to identify the effects of environmental sustainability, economic sustainability, socio-cultural sustainability and institutional sustainability on visitors' satisfaction during their visit to Kelantan's sustainable heritage tourism sites. The present study employs quantitative methods and 207 respondents participated in the survey. It was found that environmental sustainability, economic sustainability, socio-cultural sustainability and institutional sustainability have significant effects on visitors' satisfaction. Thus, all hypotheses are supported. This study provides information to tourism management in Kelantan on how sustainable tourism development can protect cultural heritage and also meet visitor demands and preferences.

**Keywords:** Tourist satisfaction, Environmental Sustainability, Economic Sustainability, Socio-Cultural Sustainability and Institutional Sustainability.

---

## INTRODUCTION

Worldwide, one of the key industries that contributes to a country's development in terms of economy, society, and environment is tourism. There are various niche markets of tourism and one of them is heritage tourism. Heritage tourism is related to travelling with the main purpose of exploring the history and heritage of a place within one particular destination. Malaysia is a country that is rich with culture and physical heritage and is focusing on the sense of place on heritage sites to ensure the continuation of heritage tourism. Hence, it is crucial to maintain the sustainability of heritage tourism sites. The term 'sustainability' reflects both the needs of the current generation and the necessity of protecting resources for future generations (Rasdi, Som, Azinuddin, Nasir, & Khan, 2022). One of the states in Malaysia that should maintain its cultural heritage is Kelantan. For decades, the state has gone unnoticed, hiding a rich wealth of cultural jewels beneath its primarily Islamic, rural appearance. Kelantan, unlike most other regions in

Malaysia, is a time capsule that retains many types of Malay cultural history. However, the serious issue facing the by heritage tourism in Kelantan is the decline of cultural identity in historical sites due to a mass tourism that influences the level of satisfaction among tourists visiting Kelantan's sustainable heritage tourism development (Aizat, 2021). Hence, to resolve this issue, the main objective of the study is to investigate the factors that influence satisfaction among tourists visiting sustainable heritage tourism development in Kelantan.

There are several objectives have been established as follows:

1. To determine the relationship between environmental dimension and tourist satisfaction visiting sustainable heritage tourism development in Kelantan.
2. To determine the relationship between economic dimension and tourist satisfaction visiting sustainable heritage tourism development in Kelantan.
3. To determine the relationship between socio-cultural dimension and tourist satisfaction visiting sustainable heritage tourism development in Kelantan.
4. To determine the relationship between institutional dimension and tourist satisfaction visiting sustainable heritage tourism development in Kelantan.

## **SIGNIFICANCE OF THE STUDY**

### **1. Kelantan Tourism Destination**

Kelantan has many heritage sites that are tourist attractions. This heritage site needs to be maintained and beautified so that it remains an attraction for foreign tourists. This place gives a uniqueness that is different from other places. With that, it will increase the economy and the income of the people in that place. Kelantan can also open many tourist attractions to attract tourists visiting any state of Kelantan and the main advantages of tourism are that it increases national income and gives locals more job opportunities.

### **2. Sustainable Tourism Development Goals**

We must protect the environment and natural resources while also bringing socioeconomic benefits to the local residents that reside inside the tourist area if we are to achieve our long-term development goals. This study shows that by maintaining a stable position in the tourism industry, it is possible to achieve many sustainable development goals, such as (1) no poverty, (2) no hunger, and (8) decent work and economic growth. In addition,

Kelantan's sustainable tourism development will allow for the preservation of both land-based and subaquatic life (objective 15).

### **3. Tourism Policy**

Governments often work with private or social actors to implement a variety of tourism-related objectives through the use of discourses, decisions, and practices known as tourism policy. Hence, the result from this study will provide an avenue for policy makers to establish policy suitable with the current needs of tourists visiting Kelantan.

## **LITERATURE REVIEW**

### **Heritage Tourism**

According to Garrod and Fyall (2001), "heritage tourism" refers to all of the activities tourists engage in when visiting places with historical sites. Pedersen (2002) asserts that heritage tourism encompasses both cultural and natural tourism, with a focus on the protection of cultural assets. Rishter (1999) defined heritage tourism as including travel to historical places, monuments, shrines, and sculptures that all serve as reminders of past occurrences. Additionally, legacy tourism covers a wide range of sites and mostly focuses on the culture, natural beauty, and historical significance of the place.

### **Tourist Satisfaction**

The concept of tourist satisfaction has been investigated thoroughly in the context of tourism marketing (Muhamad Nasir, Mohamad, & Ab Ghani, 2021a). In general, satisfaction occurs when a tourist's perception exceeds the initial expectation (Muhamad Nasir, Mohamad, & Ab Ghani, 2021b). To be specific, tourist satisfaction was defined by Servet et al. (2007) as the level of satisfaction that visitors felt during their travels in relation to qualities of a product or service that met the following criteria: Travel-related aspirations, requirements, and wants of tourists. Customer expectations before and after consumption are compared to determine customer satisfaction. Pre-trip anticipation and post-trip experiences are the two key factors that influence satisfaction. When the experience meets or surpasses expectations, visitors are happy. However, if tourists were unhappy, unhappiness would be the anticipated result (Chen & Chen, 2010; Reisinger and Turner, 2003). Understanding how suppliers in a specific destination recognise and address

visitor demands as well as identifying what aspects of the destination's current offering need to be improved are key to measuring and explaining the client's primary purpose satisfaction

### **Environmental Sustainability**

Environmental sustainability is the obligation to protect natural resources and preserve global ecosystems for current and future health and well-being (Sphera, 2022). Many of us naturally go for a stroll when we are stressed. We seek out forests, parks, beaches, and country roads to feel more at ease with nature. Environmental sustainability seeks to improve the quality of human existence while minimising the strain on the planet's supporting ecosystems. It is about striking a balance between consumerism and the living world. We can achieve this without wasting or depleting natural resources unnecessarily (Inspire,2022). Fan et al. (2012) reported that environmental sustainability has a significant effect on tourist satisfaction.

### **Economic Sustainability**

Economic sustainability refers to practises that promote long-term economic growth while minimising negative impacts on a community's social, environmental, and cultural components (University of Mary Washington 2015-2022). Economic sustainability is also the practice of safeguarding natural and financial resources in order to achieve long-term financial stability. In finance, this may imply lowering global consumption of valuable resources so that future generations can use them to build financial stability and wealth. Companies, governments, and consumers, for example, can assist minimise the global impact of fossil fuel emissions and pollution by lowering their usage of fossil fuels and focusing on alternative fuel sources. Most importantly, there is a positive correlated between economic sustainability and tourist satisfaction (Hsieh et al., 2016).

### **Socio-Cultural Sustainability**

Socio-cultural sustainability is how we as a nation maintain the well-being of our communities now and in the future by recognising, developing, and preserving core human needs such as human rights, equality, health, culture, and religion (National Library of New Zealand, 2020). People are at the heart of society's long-term growth. It acknowledges that individuals and communities have needs, values, shared experiences, and so on, all of which must be considered when planning for sustainable development. Since ancient times, humans have been migrating from one location to another for a variety of reasons such as avoiding danger, getting resources, or finding a more suited

environment. People build communities everywhere they go, developing a shared identity and a distinct culture. According to Fan et al. (2012), socio-cultural sustainability has a direct impact on tourist satisfaction.

### **Institutional Sustainability**

It is a novel approach for analysing sustainability in the environmental, social, and economic sectors. Furthermore, to support its main activities and to understand the stages of sustainable development within the three areas mentioned above, as well as matters in which leadership can be played in sustainable development by bridging the gaps that impede the process of achieving sustainable development (GDRFA, 2022). This is accomplished when institutions, structures, and procedures can continue to execute their functions across time. According to Fan et al. (2012), institutional sustainability has a major impact on tourist satisfaction.

### **Research Hypothesis**

The hypothesis of this study is to determine whether or not there is a correlation or relationship between dependent and independent variables.

H1: There is a significant relationship between environmental sustainability and tourist satisfaction.

H2: There is a significant relationship between economic sustainability and tourist satisfaction.

H3: There is a significant relationship between socio-cultural sustainability and tourist satisfaction.

H4: There is a significant relationship between institutional sustainability and tourist satisfaction.

## Research Framework

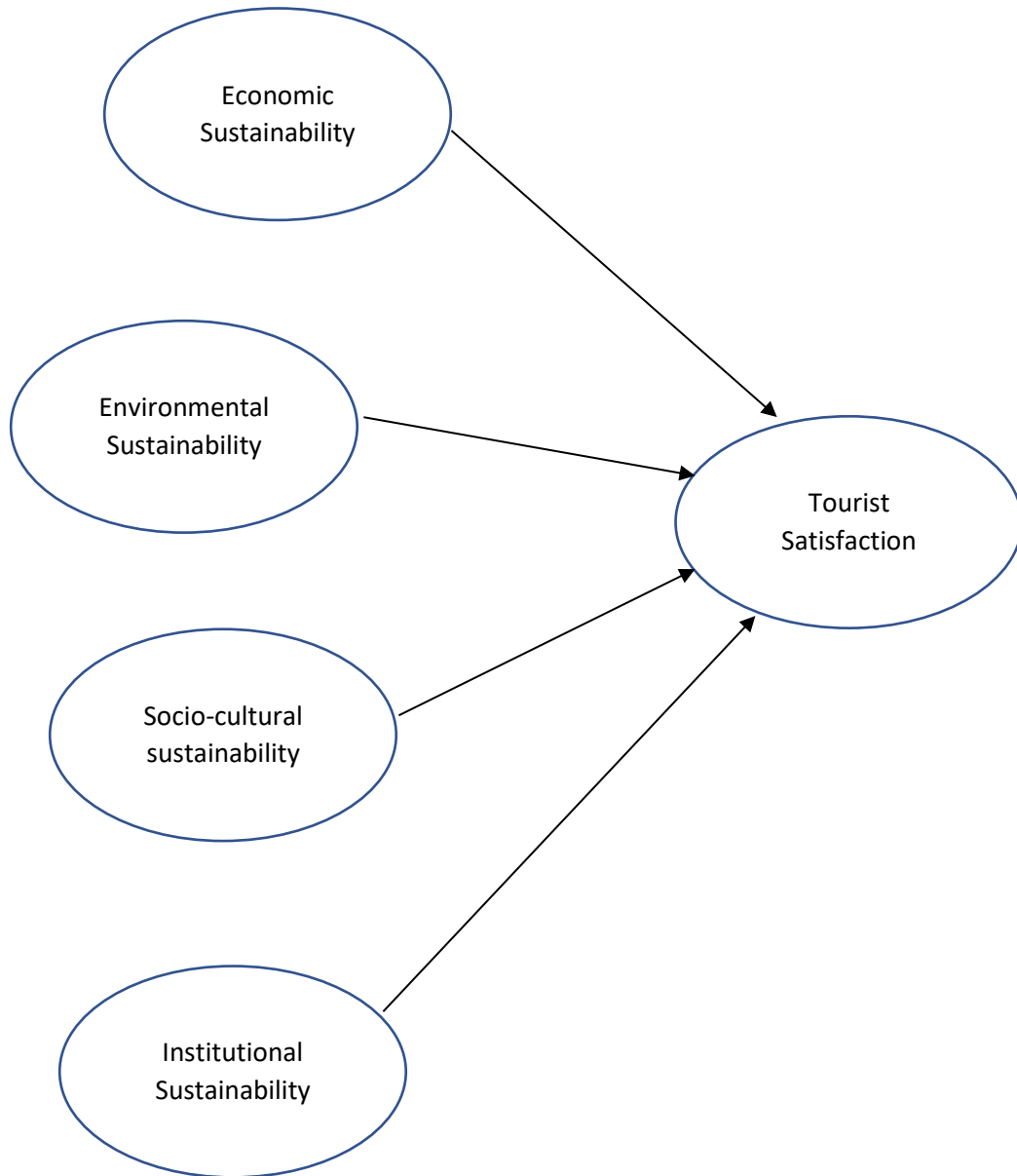



## **METHODOLOGY**

### **Research Design**

Research design is how the data to be collected, what instruments to be used as well as the intended ways on how to interpret the data collection. This study used causal research design to determine the effect of independent variables on dependent variables. Moreover, cross-sectional study is employed. The cross-sectional design is the data collection is collected at a single point in time. The unit analysis that has been used is individual. Surveys are arguably the most practical way to collect quantitative data. Therefore, this study used a self-administered questionnaire to collect data.

### **Data Collection**

This study relies on original data. The instrument we used in our study is a self-administered questionnaire using Google form. The questionnaires have been disseminated online, and we have gathered data from Malaysian domestic visitors who have visited Kelantan heritage tourism sites in the last five years. The study began with a pilot study in which 30 people took part in the survey. After that, the researcher performed a field study, in which 207 visitors participated in the survey.

### **Sampling**

For this investigation, the researchers used non-probability sampling. The technique of sampling employed is convenience sampling. Convenience sampling was used for this study because it is simple, inexpensive, and appropriate.

### **Data Analysis**

The data for this study were analyzed using the Statistical Package for the Social Sciences (SPSS), and four different types of data analyses were used: frequency analysis, descriptive analysis, reliability analysis, and Pearson Correlation analysis.

## **FINDINGS**

### **Profile of Respondents**

**Table 1: Respondent's Profile**

<b>Demographic</b>	<b>Categories</b>	<b>Frequency (N)</b>	<b>Percentage (%)</b>
Gender	Male	74	35.7%
	Female	133	64.3%
Age	18-22 years old	86	41.5%
	23-27 years old	87	42%
	28-32 years old	30	14.5%
	33-37 years old	4	2%
Religion	Buddhist	27	13%
	Muslim	154	74.4%
	Hindi	10	4.8%
	Christian	14	6.8%
	Other	2	1%
Race	Malay	152	73.4%
	Chinese	30	14.5%
	Indian	23	11.1%
	Other	2	1%
Marital Status	Single	185	89.4%
	Married	22	10.6%

State of residences	Johor	27	13%
	Kedah	8	4%
	Kelantan	26	12.6%
	Melaka	17	8.2%
	Negeri Sembilan	5	2.4%
	Pahang	17	8.2%
	Perak	18	8.7%
	Perlis	4	1.9%
	Pulau Pinang	18	8.7%
	Sabah	3	1.4%
	Sarawak	4	1.9%
	Selangor	26	12.6%
	Terengganu	17	8.2%
	Wilayah Persekutuan Kuala Lumpur	17	8.2%

Table 1 depicts the demographics of the 207 respondents. The majority of responders (64.3%) are female, with only (35.7%) being male. Most of them are at the age of 23-27 years old (42%) and the lowest frequency respondents' age is 33-37 years old with (2%). Next, in terms of religion, the majority of the respondents are Muslim with (74.4%). Meanwhile, the majority of respondents (73.4%) are Malay, while the majority of respondents (89.4%) are single. In terms of the state of residences, Johor is the highest respondents with (13%) while Sabah is the lowest which is (1.4%).

#### **Analysis for factor on satisfaction among tourist visiting sustainable heritage tourism development in Kelantan**

**Table 2: Descriptive Analysis for factor on satisfaction among tourists visiting sustainable heritage tourism development in Kelantan.**

<b>Variable</b>	<b>Items</b>	<b>N</b>	<b>Mean</b>	<b>Standard Deviation</b>
<b>Economic Sustainability</b>	Question 1: ECS 1	207	3.22	1.023
	Question 2: ECS 2	207	3.26	1.041
	Question 3: ECS 3	207	3.21	1.029
	Question 4: ECS 4	207	3.52	1.018
	Question 5: ECS 5	207	3.53	0.999
	Question 6: ECS 6	207	3.43	1.007
	Question 7: ECS 7	207	3.53	0.994
	Question 8: ECS 8	207	3.50	0.990
<b>Environmental Sustainability</b>	Question 1: ES 1	207	3.47	0.880
	Question 2: ES 2	207	3.44	0.948
	Question 3: ES 3	207	3.48	0.994

	Question 4: ES 4	207	3.66	0.982
	Question 5: ES 5	207	3.62	0.957
	Question 6: ES 6	207	3.35	1.012
	Question 7: ES 7	207	3.34	1.053
	Question 8: ES 8	207	3.55	0.998
<b>Socio-Cultural Sustainability</b>	Question 1: SCS 1	207	3.47	0.907
	Question 2: SCS 2	207	3.31	0.957
	Question 3: SCS 3	207	3.58	0.930
	Question 4: SCS 4	207	3.57	0.905
	Question 5: SCS 5	207	3.51	0.965
	Question 6: SCS 6	207	3.55	0.943
	Question 7: SCS 7	207	3.49	0.950
	Question 8: SCS 8	207	3.56	0.922

	Question 9: SCS 9	207	3.60	0.944
	Question 10: SCS 10	207	3.70	0.903
	Question 11: SCS 11	207	3.68	0.932
	Question 12: SCS 12	207	3.24	1.038
	Question 13: SCS 13	207	3.58	0.920
	Question 14: SCS 14	207	3.59	0.935
<b>Institutional Sustainability</b>	Question 1: IS 1	207	3.54	1.032
	Question 2: IS 2	207	3.51	1.047
	Question 3: IS 3	207	3.49	1.047
	Question 4: IS 4	207	3.54	1.027
	Question 5: IS 5	207	3.56	1.055
	Question 6: IS 6	207	3.48	1.110
	Question 7: IS 7	207	3.57	1.040

	Question 8: IS 8	207	3.60	1.028
	Question 8: IS 8	207	3.63	1.080
<b>Tourist Satisfaction</b>	Question 1: TS 1	207	3.75	1.031
	Question 2: TS 2	207	3.70	1.056
	Question 3: TS 3	207	3.70	1.023
	Question 4: TS 4	207	3.68	1.018
	Question 5: TS 5	207	3.75	1.012
	Question 6: TS 6	207	3.68	1.046
	Question 7: TS 7	207	3.80	1.004

In this study, the mean and standard deviation of the dependent and independent variables are shown in Table 2. The highest mean value in independent variable for economic sustainability was obtained by Question 5 with 3.53 (SD = 0.999) where “seasonality level of heritage tourism”. Meanwhile, Question 3 has the lowest mean value with 3.21 (SD = 1.029) which means “percentage of quality (stable, high paid, permanent and full-time) tourism jobs”. Independent variable for environmental sustainability had a highest mean value that belongs to Question 4 with 3.66 (SD = 0.982) which mean “value to and protection of the natural environmen”t. After that, the lowest mean value was obtained by Question 7 with 3.34 (SD = 1.053) where “the amount of litter attributed to heritage tourism is low”. Question 10 had the highest mean value for the independent variable quality of socio-cultural sustainability, with 3.70 (SD = 0.903), indicating that “contribution of local cultural values for heritage tourism development”. Question 12 has the lowest mean value of 3.24 (SD =1.038) meaning that “the percentage of criminality, alcoholism, vandalism etc caused by heritage tourism is low”. The highest mean value for independent variable institutional sustainability is Question 9 with 3.63 (SD = 1.080), which is “the level of support for conservation of heritage sites at the local level”. "Implementation of land zoning practises in attraction sites" has the lowest mean score of 3.48 (SD = 1.110). Question 7 got the highest mean value for dependent variable access to tourist satisfaction, with 3.80 (SD = 1.004), which is “accommodation (quality of food and drinks, customer handling, price fairness) in service sectors”. Question 4 has the lowest mean value of 3.68 (SD = 1.018), which is “the reasonability of entrance fee to attraction sites”.



**Relationship between economic sustainability, environmental sustainability, socio-cultural sustainability, institutional sustainability towards tourist satisfaction in Kelantan.**

**Table 3: Pearson's Correlation between economic sustainability, environmental sustainability, socio-cultural sustainability, and institutional sustainability in Kelantan and tourist satisfaction**

		Tourist Satisfaction in Kelantan
Economic sustainability	Pearson correlation	0.235
	Sig. (2-tailed)	<.001
	N	207
Environmental sustainability	Pearson correlation	0.301
	Sig. (2-tailed)	<.001
	N	207
Socio-cultural sustainability	Pearson correlation	0.222
	Sig. (2-tailed)	<.001
	N	207
Institutional sustainability	Pearson correlation	0.388
	Sig. (2-tailed)	<.001
	N	207

Table 3 shows that the association between economic sustainability and visitor satisfaction in Kelantan is 0.235, indicating a high positive link. Next is environmental sustainability and tourist satisfaction in Kelantan showed 0.301 indicating moderate strong positive correlation. Following socio-cultural sustainability and tourist satisfaction with 0.222 indicated the moderate positive correlation. Meanwhile, institutional sustainability and tourists satisfaction shows 0.388, which indicates strong positive correlation. As a result, all four variables are positively connected with tourist satisfaction, and the relationship is statistically significant ( $p < 0.05$ ). The studies findings are consistent with the past studies whereby Fan et al. (2012) claimed that environmental sustainability, socio-cultural sustainability and institutional sustainability have significant implication on satisfaction and Hsieh et al. (2016) claimed that economic sustainability has significant effect on tourist satisfaction. Thus, all hypotheses are supported.

## **DISCUSSION AND RECOMMENDATION**

The study has examined the determining factors on satisfaction among tourists visiting sustainable heritage tourism development in Kelantan. Following the results of the study, some recommendations for tourism stakeholders and future academics to improve future research have been made.

Tour operators need to play an important role in attracting tourists to visit tourist destinations in an effort to revive tourism. To attract domestic tourists, they should examine their preferences. When tourism managers and operators focus solely on international visitors, they risk misinterpreting market shifts and allocating resources inefficiently. Tourists will be drawn to the gorgeous sites and will stay longer and spend more money in Kelantan if there are more attractive attractions. As a result, domestic travel agencies and small enterprises will benefit from increased sales and profits, resulting in higher income. This will likely have long-term consequences for the travel and tourism industry. Kelantan's heritage sites can also help the state's economic viability. Therefore, we need to improve the facilities and cleanliness of the surrounding area. We also need to beautify the heritage places in Kelantan so that they always attract domestic visitors.

This work is also necessary for the continuation of future research. It is suggested that future studies explore tourist satisfaction for the development of sustainable heritage tourism by integrating demographic features of more respondents. For example, race, religion, monthly income, marital status, occupation, and so on, in order to get distinct outcomes or conclusions from various perspectives. Researchers can gather more detailed data this way.

Future researchers could also improve data gathering for this study, particularly in terms of questionnaire dissemination. Future researchers could hand out questions in person rather than using Google Forms. This is because some respondents refused to answer the questionnaire, which the researchers submitted via Google Forms. As a result, when surveys are presented in person to potential responders, the response rate is higher.

## CONCLUSION

Finally, this study was completed to determine the determining element of satisfaction among domestic visitors visiting Kelantan's sustainable heritage tourism development. The research presents the study's four objectives. Moreover, Economic sustainability, environmental sustainability, socio cultural sustainability and institutional sustainability have significant effects on satisfaction. These findings are based on 207 respondents who participated in the study. Hence, all hypotheses are supported.

## REFERENCES

- Akter, M., Sadekin, M. N., & Patwary, A. K. (2020). An Empirical Study on Students' Satisfaction from Mawlana Bhashani Science & Technology University, Bangladesh. *Review of Economics and Development Studies*, 6(2), 363-379.
- Alom, S., Patwary, A. K., & Khan, M. M. H. (2019). Factors affecting the turnover intention of Bangladeshi migrants in the United Arab Emirates: An empirical study on the hotel industry. *International Journal of Innovation, Creativity and Change*, 8(3), 344-360.
- Economic Sustainability. Office of Sustainability. (2019, September 19). <https://sustainability.umw.edu/areas-of-sustainability/economic-sustainability/>
- Environmental Design, International Islamic University Malaysia, (2021). Retrieved from <http://studentrepo.iium.edu.my/handle/123456789/11004>
- Etravel team (2022). What is Heritage (Historical) Tourism? Retrieved from
- Fan JH, et al. (2012): SGD. Fan JH, et al. (2012) | SGD. (n.d.). <https://www.yeastgenome.org/reference/S000151611>
- Fengmin, Z., Baijun, W., Jiangtao, B., Li, L., & Patwary, A. K. (2022). Investigating revisit intention of medical tourists in China through nutritional knowledge, perceived medical quality, and trust in the physiologist: A recommendation on health tourism policy measures. *Frontiers in Public Health*, 10, 893497.
- Garrod and Fyall. (n.d.). How to access research remotely. <https://www.cabdirect.org/cabdirect/abstract/20013121160>
- Garrod, B., & Fyall, A. (2001). Heritage tourism: A question of definition. *Annals of tourism research*, 28(4), 1049-1052.

- Hazbar, A. M. H., Alem Mohammed, A., & Karim, A. K. A. (2019). An Empirical Study of Factors Influencing hotel customers' online booking Intention. *مجلة العلوم التربوية و الدراسات الإنسانية*, (5), 1-17.
- How to access research remotely. (n.d.).  
<https://www.cabdirect.org/cabdirect/abstract/20013121160>  
<https://www.etravel.com/explore/travel-industry/what-is-heritage-tourism/>  
[https://www.researchgate.net/publication/314089854\\_Tourism\\_Policy](https://www.researchgate.net/publication/314089854_Tourism_Policy)  
<https://www.sciencedirect.com/science/article/pii/S2405844018368336>
- IGI GLOBAL (1988-2012). What is Tourism Development? Retrieved from <https://www.igi-global.com/dictionary/the-engineering-of-territorial-tourism-study-case-of-algeria/49800>
- IGI GLOBAL (1988-2012). What is Tourist Satisfaction? Retrieved from <https://www.igi-global.com/dictionary/a-new-frontier-in-the-satisfaction-of-the-cultural-tourist/39285>
- Ismail, N., Masron, T., & Ahmad, A. (2014). Cultural heritage tourism in Malaysia: Issues and challenges. SHS Web of Conferences, Retrieved from [https://www.researchgate.net/publication/307656952\\_Cultural\\_Heritage\\_Tourism\\_in\\_Malaysia\\_Issues\\_and\\_Challenges](https://www.researchgate.net/publication/307656952_Cultural_Heritage_Tourism_in_Malaysia_Issues_and_Challenges)
- Li, L., Ragavan, N. A., Patwary, A. K., & Baijun, W. (2022). Measuring patients' satisfaction toward health tourism in Malaysia through hospital environment, nutritional advice, and perceived value: A study on Chinese exchange students. *Frontiers in public health*, 10, 893439.
- Li, L., Wu, B., & Patwary, A. K. (2022). How marine tourism promote financial development in sustainable economy: new evidences from South Asia and implications to future tourism students. *Environmental Science and Pollution Research*, 29, 1155-1172.
- Li, L., Wu, B., & Patwary, A. K. (2022). The psychosocial factors affecting chinese Outbound Exchange and mobility students' academic performance during COVID-19. *Frontiers in psychology*, 13, 872516.
- Mittuniversitetet (2022). Economic Dimension. Retrieved from <https://www.miun.se/en/Research/research-centers/etour/evenemangskompassen/Getting-Started/The-Dimensions/Economic-Dimension/>
- Muhamad Nasir, M. N., Mohamad, M., & Ab Ghani, N. (2021a). Understanding the behaviour of international tourists from China visiting Malaysia: proposing a conceptual model. *Journal of Marketing Advances and Practices*, 3(2), 1-16.
- Muhamad Nasir, M. N., Mohamad, M., & Ab Ghani, N. I. (2021b). Modelling the relationships between destination attractiveness, service quality, tourist satisfaction and destination loyalty. *Asia-Pacific Journal of Innovation in Hospitality and Tourism*, 10(2), 1-19.
- Patwary, A. K., Roy, B., Hoque, R., & Khandakar, M. S. A. (2019). Process of developing a community based tourism and identifying its economic and social impacts: An Empirical study on Cox's Bazar, Bangladesh. *Pakistan Journal of Humanities and Social Sciences*, 7(1), 1-13.
- Rasdi, A. L. M., Som, A. P. M., Azinuddin, M., Nasir, M. N. M., & Khan, N. F. A. H. (2022). Local community perspective on responsible tourism and destination sustainability. *Planning Malaysia*, 20(3), 255-269.
- Reisinger, Y., & Turner, L. W. (2003). *Cross-cultural behaviour in tourism: Concepts and analysis*. Elsevier.

- Research on tourist satisfaction and dissatisfaction: Overcoming the ... (n.d.). [https://www.researchgate.net/publication/247764665\\_Research\\_on\\_tourist\\_satisfaction\\_and\\_dissatisfaction\\_Overcoming\\_the\\_limitations\\_of\\_a\\_positivist\\_and\\_quantitative\\_approach](https://www.researchgate.net/publication/247764665_Research_on_tourist_satisfaction_and_dissatisfaction_Overcoming_the_limitations_of_a_positivist_and_quantitative_approach)
- Research on tourist satisfaction and dissatisfaction: Overcoming the ... (n.d.). [https://www.researchgate.net/publication/247764665\\_Research\\_on\\_tourist\\_satisfaction\\_and\\_dissatisfaction\\_Overcoming\\_the\\_limitations\\_of\\_a\\_positivist\\_and\\_quantitative\\_approach](https://www.researchgate.net/publication/247764665_Research_on_tourist_satisfaction_and_dissatisfaction_Overcoming_the_limitations_of_a_positivist_and_quantitative_approach)
- Richards, G. (2021). Emerging cultural tourism practices: New opportunities for small cities?. *Turisztikai és Vidékfejlesztési Tanulmányok*, 6(4). Retrieved from <https://journals.lib.pte.hu/index.php/tvt/article/view/5144/4970>
- Richter, L. (2009). Tourism policy-making in Southeast Asia: A twenty-first century perspective. *Tourism in Southeast Asia: Challenges and new directions*, 132-145.
- Sumethokula, P., Patwary, A. K., Srinuanpanc, B., Srinuanpand, C., Suwandee, P., Thammathikul, A., & Phanong, W. (2020). The potential of new tour repackaging for creative tourism among entrepreneurs in Nakhon Si Thammarat. *International Journal of Innovation, Creativity and Change*, 13(10), 1752-1771.
- Team, S. E. (2022, November 1). Safety report 2022. Sphera. <https://sphera.com/report/safety-report-2022/>
- The structural relationship between tourist satisfaction and sustainable heritage tourism development in Tigray, Ethiopia. *Heliyon*, 5(3), e01335. Retrieved from
- Transportation Engineering (Second Edition), (2022). Environmental Dimension. Retrieved from <https://www.sciencedirect.com/topics/engineering/environmental-dimension>
- Valčić, M., & Domšić, L. (2012). Information technology for management and promotion of sustainable cultural tourism. *Informatika*, 36(2). Retrieved from <https://informatika.si/index.php/informatika/issue/viewFile/143/130>
- Wu, B., Liu, S., Wang, J., Tahir, S., & Patwary, A. K. (2021). Assessing the mechanism of energy efficiency and energy poverty alleviation based on environmental regulation policy measures. *Environmental Science and Pollution Research*, 28, 40858-40870.
- Wu, B., Zhai, B., Mu, H., Peng, X., Wang, C., & Patwary, A. K. (2021). Evaluating an economic application of renewable generated hydrogen: A way forward for green economic performance and policy measures. *Environmental Science and Pollution Research*, 1-15.

# The Relationship Between Memorable Experience, Travel Satisfaction, and Tourist Expectation on Revisit Intention Among Tourist in Malaysia

Lim Xin Min, Low Jun Xuan, Luqman Nur Hakim Rahmat, Maisarah Ghzali, Marlisa Abdul Rahim\*

*Faculty of Hospitality, Tourism and Wellness, Universiti Malaysia Kelantan*

marlisa@umk.edu.my

---

## ABSTRACT

Revisit intention is expressed as the desire of the tourists to revisit the destination in another time period. A tourist's loyalty to a place is demonstrated by his or her desire to visit it again as well as by their willingness to suggest it to others. The goal of this study is to examine the variables that affect local visitors' intentions to return. The purpose of this study is to clarify the connection between memorable experiences, travel satisfaction, and tourist expectations on revisit intention among tourists in Malaysia. These factors are vital in making tourists in Malaysia have the intention to revisit a destination. The main data for the study will be collected by using a structured questionnaire, and the analysis will be done by using SPSS software. The survey will be distributed to 384 respondents of revisit intention in any destination in Malaysia. In this study, descriptive, reliability tests, and correlation analyses were utilised to process the data. Researchers want to get a deeper insight into the variables influencing local tourists' intention to return through this study.

**Keywords:** Revisit intention, memorable experiences, travel satisfaction, tourist expectation, tourist

---

## INTRODUCTION

The phrase "revisit intention" refers to a subjective evaluation of how likely it was that mainland Chinese residents would return to Hong Kong. It is possible that the chance of accomplishing the targeted return behaviour was utilised to compute revisit intention (Zhang 2018). Tourism is described as "activities of persons who travel to and stay in places outside their usual environment for leisure, business, and other purposes not related to the exercise of an activity remunerated from within the place visited" (Messori, 2021).

The similar thing happened in Malaysia in terms of tourism interaction; if the locations could deliver enough memorable experiences, travel satisfaction, and outstanding tourist expectations, the likelihood of tourists returning to the place would grow. Repeat visitors are a desired market segment for many destinations because they tend to stay longer at the destination, are more satisfied as a result of experience and realistic expectations, spread positive word, participate in activities more intensively, and require much lower marketing costs than first-time visitors (Huang, 2009). According to Abubakar (2017), repeat users of tourist services who have previously encountered the real delivery of the service. The majority of those tested projected return intention as an extension of enjoyment acquired from the original encounter (Huang, 2009). On top of that, the destination would received a valuable income from the revisit tourists

based on their based on their expenditures on tourism products and services during their stay in a particular destination (Nasir et al., 2021)

Internal and external developments in the tourism business, as in other sectors, directly or indirectly created both benefits and risks in terms of tourist attractions. Successful tourist officials kept an eye on these trends and implemented safeguards ahead of time (Etinsöz, 2013). It stated that repeat tourists were more significant in providing a consistent source of income than the role they played in informing future visitors. Repeat visitors were unconcerned about competitor locations or price tactics. Repeat tourists are an important concept for maturing destinations, and their continuance was an essential element in an attraction remained competitive and growth in tourism. This the same according to Kozak (2001) the quality of local transported service and destination airport service affected tourists' intention to visited other placed in the same country, whereas destination satisfaction founded to been the strongest predictor of both intention to revisit the same holiday destination and other destinations within the country. Internal and external developments in the tourism business, as in other sectors, resulted in both benefits and challenges in terms of tourist attractions. Successful tourist authorities monitored these trends and made safeguards in advance (etinsöz, 2013). It suggested that repeat tourists were more significant in providing a consistent source of income than the role they performed in disseminating information to future visitors. Repeat visitors were unaffected by competitor locations or price initiatives.

According to the research, even the quality of service had a significant influence on attracting visitors to return to the same site. The aspect investigated in this study was memorable experiences, travel satisfaction, and tourist expectations. When determining target region and searching for travel information, people tended to recall prior experiences first (Gohary, 2019). When tourist expectations about the place were correct, this resulted in a pleasure to enjoy the attractions and had a fantastic unforgettable experience visitor, the intention to explore the destination again was high.

There are three objectives of this research:

1. To examine the relationship between memorable experiences and revisit intention among tourists in Malaysia.
2. To analyze the relationship between travel satisfaction and revisit intention among tourists in Malaysia.
3. To analyze the relationship between tourist expectations and revisit intention among tourists in Malaysia.

## **SIGNIFICANCE OF THE STUDY**

### **Researchers**

The findings of the study would have assisted the researchers in determining the relationship between tourist expectations, memorable experiences, and revisit intention among tourists in Malaysia. The studied could gave additional information to students and researchers about their academic studied. The studied helps researchers to did other researched in ordered to give factors, examples and references that influence the revisit intention among tourists in Malaysia.

## **Tourism Players**

This studied would provided information about the individual's perspective about their reasoned to revisit again the placed to had been went. The studied could assist tourism players to improved their facilities and service to promote their business and attracted tourists. Travelled agencies, hotels, and restaurants improved their business by influenced tourists to revisit their placed and attracted old and new tourists.

## **Tourism Ministries**

The data and statistics in the studied may benefit to guided tourism ministries to made a new improvement in tourism industries to attracted tourists in Malaysia. The tourism government could used this researched as an example to have done a researched about trend of tourist in Malaysia.

## **LITERATURE REVIEW**

### **Revisit Intention**

A visit intention is the tendency or desire to go back to a particular location or event in the future (Rasoolimanesh et al., 2021). It expresses a person's desire to go back to a particular place, be it a favourite vacation spot, a dining establishment, a shop, or any other special spot.

Positive past experiences, a feeling of pleasure or satisfaction, or a desire to learn more about and participate with the location or event can all have an impact on the intention to revisit (Torabi et al., 2022). It denotes the possibility of a return trip and illustrates the general allure and allure of the location or activity.

### **Memorable Experiences**

A memorable experience is one that has a lasting impression on our thoughts, feelings, and recollections (Cho, 2022). These encounters are frequently distinguished by their singularity, intensity, and the breadth of their impact. They distinguish themselves from the commonplace and routine, grabbing our attention and leaving us with treasured memories that we keep with us over time. Significant adventures, life milestones, significant relationships with others, or encounters that arouse powerful emotions can all be considered memorable experiences. They have the capacity to alter our viewpoints, encourage personal development, and provide opportunities for enjoyment, introspection, and storytelling. These experiences, whether they are favourable or difficult, are crucial in determining who we are and how we view the world (Hosany et al., 2022).

### **Travel Satisfaction**

The term "travel satisfaction" describes the general happiness and fulfilment people feel after finishing a journey or holiday (Abenoza et al., 2018). It includes how much fun was had, how expectations were met, and how much the traveler's wants and needs were met or exceeded by the event. The standard of accommodation, transportation, attractions, customer service, cultural immersion, safety, and overall travel experience are some of the variables that can affect how satisfied travellers are with their trips. Due to the fact that every person has a varied set of



preferences and expectations, it is subjective and differs from person to person. Travel pleasure ultimately reflects how well a travel experience fits a person's preferences and adds to their overall happiness and sense of fulfilment (Yang et al., 2022).

## **Tourist Expectation**

Tourist expectations are the hopes and wishes that people have before leaving on a trip or participating in a tourist activity. These expectations might be very different based on things like individual preferences, driving forces, life experiences, cultural background, and knowledge of the location or activity (Rangaiah, 2021). Tourists frequently have high expectations for things like the standard of the accommodations, attractions, food, transportation, safety, cultural authenticity, hospitality, and overall contentment. They act as a standard by which the actual experience is measured and have a big impact on how people view a place or activity. To provide great experiences and promote visitor satisfaction, it is essential to meet or exceed these expectations (Franklin, 2023).

## **The relationship between memorable experiences, travel satisfaction, and travel expectation on revisit intention among local tourists in Malaysia**

Memorable experiences and revisit intention are closely related. A memorable experience leaves a powerful, favourable impression on people and has a long-lasting effect on their memories (Kane, 2018). These encounters frequently elicit positive emotions such as fulfilment, joy, and happiness. As a result of wanting to reproduce or relive that great experience, people are more likely to have a high revisit intention. A memorable encounter can create an emotional bond that can lead to a yearning to go back to the location or do the activity once more. Thus, as they foster a good association and a desire to go back, memorable experiences can considerably affect and raise the chance of revisit intention (Lu et al., 2022).

Travel satisfaction and revisit intention are tightly related. People are more pleased and fulfilled with their travels overall when they have a positive travel experience (Bayih, 2020). This happy feeling prompts a desire to return to the same location in order to repeat or lengthen the experience. Travel happiness is frequently influenced by elements like engaging activities, comfortable lodgings, excellent service, cultural immersion, and positive encounters. When these factors meet or even surpass visitors' expectations, they feel a stronger connection to the place and are more likely to want to go again. Because people are compelled to reproduce the pleasant experience and further explore or deepen their relationship with the destination, high levels of travel pleasure often correlate with an increased revisit intention (Chan, 2020).

Expectations of tourists significantly influence their intentions to return. When tourists have preconceived notions about a place or a tourism experience, it creates a standard by which their actual experience is measured (Jebbouri et al., 2021). If their expectations are met or surpassed, it leaves a favourable impression and raises the possibility that they may decide to return. Meeting or exceeding visitor expectations can promote a feeling of fulfilment, happiness, and satisfaction, which in turn increases the desire to return to the location. However, if the encounter falls short of expectations, it may cause disappointment and lessen the likelihood that the visitor will return. As a result, there is a significant link between visitor expectations and

intent to return, with the degree to which expectations are met directly influencing the desire to return to the destination (Culic et al., 2021).

### Research Hypothesis

A hypothesis need to be plausible, testable, and take into account the most recent discoveries and methodologies. A forecast or an explanation of the relationship between two variables is also referred to as a hypothesis. It suggests that an independent variable and a dependent variable are related causally.

As a result, the research suggests:

H1: Memorable experiences have a positive relationship with revisit intention.

H2: Travel satisfaction is positively associated with tourist revisit intention.

H3: Tourist expectations have a positive relationship with revisit intention.

### Research Framework

The conceptual framework for this research is seen in Figure 2.1. The three factors that make up the independent variable that will be proposed are memorable experiences, tourist travel satisfaction, and tourist expectations. Revisit intention is the dependent variable.

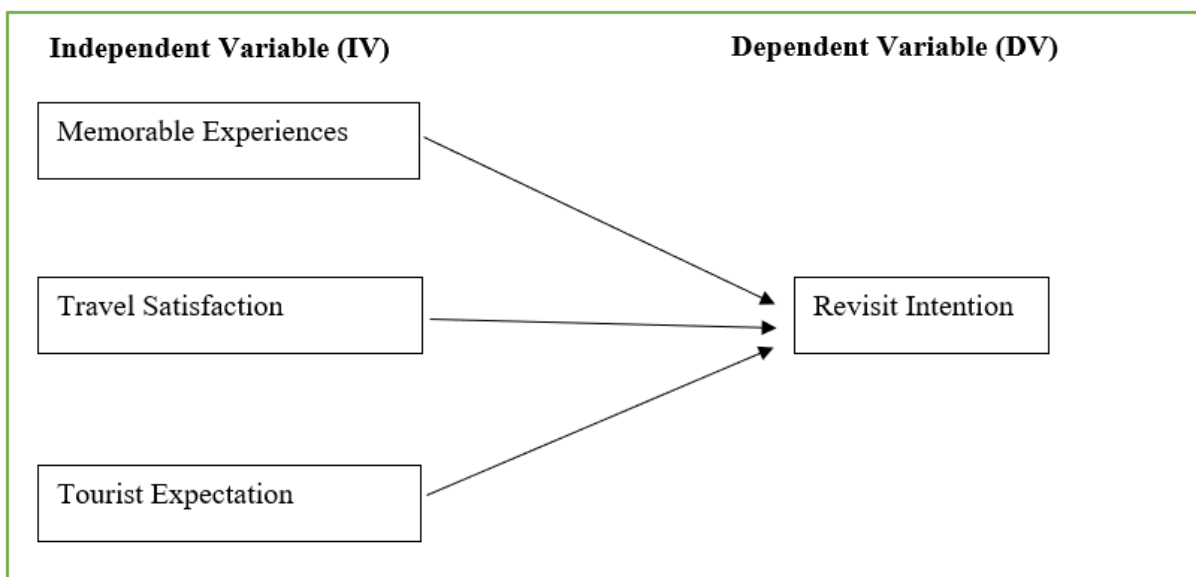

Figure 2.1: Conceptual Framework of Memorable Experiences, Travel Satisfaction, and Tourist Expectation towards the Tourists' Revisit Intention

## METHODOLOGY

### Research Design

The study's design incorporates the relationship between memorable experiences, tourist travel satisfaction, and tourist expectation on revisit intention among tourists in Malaysia. This study will use quantitative research among local tourists in Malaysia. A descriptive study design helps to address the research question and fulfill the research objectives.

### Population and Sample Size

Overall, there are 66 million people in Malaysia's target market, including domestic visitors. This study only includes local tourists in Malaysia as its research population. In this study, sample size calculations were made using a table based on Krejcie & Morgan (1970) for a specific demographic. By Krejcie and Morgan in 1970:

S = sample size

$X^2$  = the table value of chi-square for 1 degree of freedom at the desired confidence level (3.841)

N = the population size of domestic tourist in a year

P = the population proportion (assumed to be 0.5 since this would provide the maximum sample size)

d = the degree of accuracy expressed as a proportion (0.5)

$$S = \frac{x^2NP(1-P)}{d^2(N-1)+(x^2P(1-P))}$$

$$S = \frac{3.841(2054000000)(0.5)(1 - 0.5)}{(0.05)^2(2054000000 - 1) + 3.841(0.5)((1 - 0.5))}$$

$$S = \frac{197235300}{5135000.958}$$

$$S = 384.099$$

$$S = 384$$

The precise sample size for the population is 384, but only 200 respondents' responses to the questionnaire were collected for data.

### Data Collection

Online questionnaires that employed Google forms were used as the initial data collection technique in this investigation. Because it is free and user-friendly, the researcher used this platform of technological tools. Additionally, it makes it simpler for researchers to get all the information from regional tourists. Three components make up the questionnaire created to collect data from domestic tourists. Questionnaires were also used as the primary data gathering tool in this investigation. Respondents are required to answer three questions in each of the three sections. To gather information about the population of local tourists in Malaysia, a questionnaire was made available to them.

### Sampling

Sampling is a technique for obtaining data in academics to learn regarding a particular population by studying the findings of a sample of people rather than focusing on some specific individuals (Turner, 2020). Probability sampling and non-probability sampling are examples of the types of

sample techniques employed in this study. Random samples are used in probability sampling, enabling important inferences more about overall demography to be drawn (Stratton, 2021). Non-probability sampling is frequently related with qualitative research and the construction of research articles (Taherdoost, 2016). The non-probability approach, for example, a simple sampling method, was chosen as the sample design in this investigation.

In this study, convenience sampling will be used. Convenience sampling will be helping researchers to collect data. It's the most commonly utilised sample technique because it's incredibly quick, simple, and cost-effective (Fleetwood, 2020). Because of the advantages and application of multiple sampling approaches in circumstances when there are big populations, this method was chosen for this investigation.

### Research Instrument

The questions used to measure the selected research constructs were taken from earlier studies in the area of traveler behaviour.

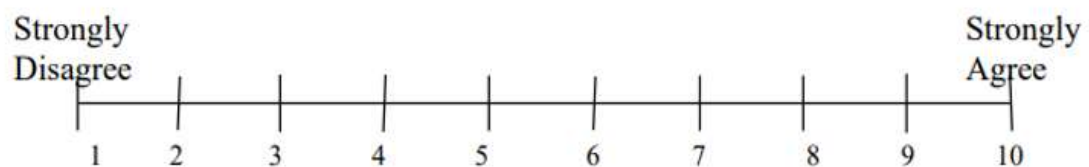

Figure 2: Measurement of Likert scale

Table 1: Source of Measurement

Variable	Source of Measurement Items
Revisit Intention	Harun et al., (2018)
Memorable Experience	Amir et al., (2015)
Tourist Travel Satisfaction	Lee et al., (2011)
Tourist Expectation	Solis-Radilla et al., (2019)

### Data Analysis

The programme Statistical Programmers for Social Science (SPSS) version 29.0 will be used by researchers to analyse the primary data. You can make tables and pie charts using the program-based data processing and analysis window known as SPSS. Computers aided researchers in

lowering the effort required to determine information and making quantitative analysis easily and quickly. The researcher uses descriptive statistics, reliability statistics, Pearson's correlation, and regression to evaluate quantitative data.

## FINDINGS

### Demographic Profile of Respondent

Table 2: Demographic Profile of Sample

Characteristics		Frequency	%
Age	18-30 years old	85	42.5
	31-40 years old	88	44.0
	41-50 years old	18	9.0
	51 and above	9	4.5
Gender	Male	68	34.0
	Female	132	66.0
Ethnicity	Malay	137	68.5
	Chinese	46	23.0
	Indian	15	7.5
	Others	2	1.0
Occupation	Civil Servant	11	5.5
	Enterprise Staff	11	5.5
	Freelancer	2	1.0
	Self-employed	11	5.5
	Student	158	79.0
	Others	7	3.5
Marital Status	Married	32	16.0
	Unmarried	168	84.0
Travel Frequencies	1-2 times	88	44.0
	3-5 times	32	16.0
	More than 5 times	80	40.0
Travel Period	Anytime	43	21.5
	Semester breaks	61	30.5
	Weekends or Public Holidays	96	48.0
Preferred Travel Spot	Beach Vacation	55	27.5
	Camping Vacation	30	15.0

	City Vacation	55	27.5
	Theme Parks	29	14.5
	Abroad	31	15.5

Table 2 presents an overview of the responder profile. The age group from 31 to 40 years old had the highest percentage of responders (44.0%), followed by the age group from 18 to 30 years old (42.5%), the age group from 41 to 50 years old (9.0%), and the age group from 51 years and older (4.5%). Male respondents made up 68 of the total respondents, while female respondents made up 132. 200 people replied to the survey, including 137 Malay, 46 Chinese, 15 Indian, and 2 others. Malay respondents made up the majority of the sample (68.5%), followed by Chinese respondents (23.0%), Indian respondents (7.5%), and other respondents (1.0%).

The majority of respondents, at 79.0% (158 respondents), were students. 5.5% (11 respondents) of the respondents worked as civil servants, 5.5% (11 respondents) as enterprise staff, 5.5% (11 respondents) as self-employed, 3.5% (7 respondents) worked in other occupations, and 1.0% (2 respondents) employed freelancers.

In addition, there were 32 respondents who were married, making up 16.0% of the 168 respondents who were unmarried overall. The questionnaire was completed by 44.0% (88 respondents) of those with 1-2 times for travel frequencies, 40.0% (80 respondents) of those with more than 5 times for travel frequencies, and the lowest proportion of respondents were those with 3-5 times, which is 16.0% (32 respondents).

Furthermore, the highest was 48.0% (96 respondents) who chose to travel during weekends or public holidays, followed by 30.5% (61 respondents) who chose to travel during the semester break, and the lowest were 21.5% who chose to travel anytime (43 respondents).

Moreover, there were 55 respondents who preferred to refer to beach vacation (27.5%), 30 respondents who chose to do camping vacation (15.5%), and 55 respondents who preferred to do city vacation (27.5%). Then, 29 respondents chose theme parks as their travel spot (14.5%), meanwhile 31 respondents chose abroad as their travel spot (15.5%).

## Reliability Test

A reliability system is employed to evaluate a system's overall performance and stability over a specific time period and in various testing scenarios. Before being distributed to 200 respondents via an online survey, the pilot test was carried out with 30 participants.

Table 3: Results of Reliability Test

Variable	Number of items	Cronbach's Alpha coefficient	Strength of Association
Revisit Intention	5	0.934	Excellent
Memorable Experience	5	0.953	Excellent
Travel Satisfaction	5	0.923	Excellent

Tourist Expectation	5	0.947	Excellent
---------------------	---	-------	-----------

Table 3 displays the independent and dependent variable's Cronbach's Alpha Coefficient values. The table above shows that all of the variables were more than 0.9. As a result, the drawn conclusion can be trusted and used in this investigation. The Revisit Intention variable, which affected tourists' intentions to revisit Malaysia, was measured using five questions. Table 4.2 revealed that the question in this section had an exceptional Cronbach's Alpha score of 0.934. As a result, the coefficients found for the revisit intention variable's questions were accurate.

Following that, the Memorable Experience variable that influenced tourists to revisit intention in Malaysia was measured using 5 questions, and the Cronbach's Alpha score for the question in this area was an amazing 0.953. The coefficients obtained for the questions related to the memorable experience variable were therefore accurate.

Five questions were used to gauge travel satisfaction and revisit intention in Malaysia. The score was 0.923, which is outstanding. The coefficients determined for the travel satisfaction factors were therefore accurate.

Finally, in measuring the Tourist Expectations that influenced tourists to revisit intention in Malaysia, five questions were used and the Cronbach's Alpha result for this section's question was 0.947 which indicated excellent. Therefore, the coefficients obtained for these questions in measuring the Tourist Expectations that influenced tourists to revisit intention in Malaysia were also reliable. Since Cronbach's Alpha charge for the variables exceeded 0.8, it may be concluded that surveys are extremely trustworthy and that the study can proceed.

### Descriptive Analysis

The mean and standard deviation for the questionnaire parts B and C have been examined in this study.

Table 4: Descriptive Statistics

Variables	N	Mean	Standard Deviation
Memorable Experience	200	8.0260	1.86822
Travel Satisfaction	200	8.4990	1.86844
Tourist Expectation	200	8.2400	1.96077
Revisit Intention	200	8.1990	1.94820

Table 4 shows the mean and standard deviation analysis for the independent and dependent variables. The dependent variable was the revisit intention in Malaysia. Memorable Experience, Travel Satisfaction, and Tourist Expectation were independent variables. Travel Satisfaction had the highest mean score, 8.4990, indicating that respondents were more in agreement with this characteristic. The variable with the lowest mean value in this study's respondents' agreement

was Memorable Experience, which has a value of just 8.0260. The data set that has more dispensing values has a standard deviation of more than 1 out of 200 respondents.

### Pearson Correlation

Pearson's correlation analysis was one of the most significant analyses that looked at the linear relationship between the two variables. This study's objective was to determine whether there were any correlations between the dependent variable which is revisit intention in Malaysia and the independent variables which are memorable experience, travel satisfaction, and tourist expectation. The researchers must decide what level of association strength is appropriate if the relationship is significant.

### Hypothesis 1

H<sub>1</sub>: Memorable experiences have a positive relationship with revisit intention.

Table 5: Correlation coefficient for memorable experience and revisit intention among tourists in Malaysia

		Revisit Intention	Memorable Experience
Revisit Intention	Pearson Correlation	1	.835**
	Sig. (2-tailed)		<.001
	N	200	200
Memorable Experience	Pearson Correlation	.835**	1
	Sig. (2-tailed)	<.001	
	N	200	200

Table 5 showed the 200 examples, the significant value, and the Pearson correlation coefficient. The p-value was less than 0.01 and below the threshold of significance of 0.01. A strong positive association between a memorable experience and revisit intention may be seen in the correlation coefficient of 0.835.

### Hypothesis 2

H<sub>2</sub>: Travel satisfaction is positively associated with tourist revisit intention.



Table 6: Correlation coefficient for travel satisfaction and revisit intention among tourists in Malaysia

		Revisit Intention	Travel Satisfaction
Revisit Intention	Pearson Correlation	1	.867**
	Sig. (2-tailed)		<.001
	N	200	200
Travel Satisfaction	Pearson Correlation	.867**	1
	Sig. (2-tailed)	<.001	
	N	200	200

Table 6 showed the 200 examples, the significant value, and the Pearson correlation coefficient. The p-value was less than the significant level of 0.01 at 0.01, or 0.01. The 0.867 correlation value indicated a strong positive relationship between tourist satisfaction and revisit intention.

### Hypothesis 3

H<sub>3</sub>: Tourist expectations have a positive relationship with revisit intention.

Table 7: Correlation coefficient for tourist expectation and revisit intention among tourists in Malaysia

		Revisit Intention	Tourist Expectation
Revisit Intention	Pearson Correlation	1	.823**
	Sig. (2-tailed)		<.001
	N	200	200
Tourist Expectation	Pearson Correlation	.823**	1
	Sig. (2-tailed)	<.001	
	N	200	200

Table 7 showed the 200 examples, the significant value, and the Pearson correlation coefficient. The p-value was less than the significant level of 0.01 at 0.01, or 0.01. Tourist expectations and revisit intention were strongly positively correlated, according to the correlation coefficient of 0.823.

Table 8: Summary of Correlation Analysis

Hypot he sis	Significant Value	Conclusio n	Correlation Value	Conclusion
1	0.000	Accepted	0.835	High Positive Correlation
2	0.000	Accepted	0.867	High Positive Correlation
3	0.000	Accepted	0.823	High Positive Correlation

To ascertain the linear relationship between the two variables listed as the study's goals, researchers performed correlation analysis. The findings of the correlation analysis are presented in Table 8, which showed a very strong correlation between the memorable experience, travel satisfaction, and tourist expectation towards revisit intention among local tourists in Malaysia.

## DISCUSSION AND RECOMMENDATION

The purpose of the study was to ascertain the connection between memorable experiences, travel satisfaction, tourist expectations, and revisit intention. The goal of this study is to understand the connection between memorable experiences, travel satisfaction, and tourist expectations on revisit intention among tourists in Malaysia.

Because this study was restricted to Malaysian tourists, it was unable to reach a respondent because not all local tourists in Malaysia can be respondents who wanted to answer questions or receive a questionnaire from the researchers. This study therefore suggests that more research on local tourist travel in Malaysia should be conducted. The findings of this study point to the need for additional research on foreign tourists visiting Malaysia because it only looked at local visitors to the country. Future research on foreign tourists visiting Malaysia could compare the results with those of this study. This research may produce different findings if it relates to overseas visitors to Malaysia.

The current study also only took into account three other variables or other types of characteristics that affect how Malaysian tourists behave as tourists. Other key elements that are relevant in influencing revisit intention among tourist in Malaysia may have been overlooked in this study. Such as, service quality, social influence, tourist motivation, and destination image. Variety of factors can create a variety of results for the research.

The investigation is then focused on Malaysian tourists. 200 out of the 384 total replies to the survey were useful and may be examined. According to Krejcie and Morgan (1970), larger sample sizes could be used to assess millions of Malaysian tourists if the number is sufficiently

dependable. Consequently, future researchers should increase their sample size in order to enhance the validity and reliability of their studies. As a result, this research limited the sample to 200. This amount is considered small and the range of respondents are limited. The further research should have a large sample size from 200 to 300. The size of respondent and answer will be varieties.

Furthermore, the use of a qualitative technique approach rather than having people respond to a scale questionnaire online. A study approach known as the qualitative method aims to gather and examine non-numerical data in order to better understand people's social reality, including attitudes, beliefs, and motivation. As a result, various method methods can produce various outcomes for future research.

Finally, future researchers should be undertaken up to date on variables that might impact revisit intention towards local tourists in Malaysia because the factors can fluctuate. The goal of the study is to understand how positive memorable experiences, tourist satisfaction, and tourist expectations relate to revisit intention among tourists in Malaysia. The findings of the research goals that look at the relationship between memorable experience, travel satisfaction, and tourist expectation that influence revisits intention among tourists in Malaysia is accepted. Meanwhile, such outcomes can be predicted regarding the factors of a memorable experience, travel satisfaction, and tourist expectation that influence tourist revisit intention in Malaysia.

## **CONCLUSION**

In a nutshell, visitors' contentment and plans to return were thought to be impacted by pleasant, positive memorable experiences, travelling satisfaction, and tourist expectations. These three criteria were addressed simultaneously to increase the likelihood of tourist revisit intention, as this was one of the most important factors influencing tourist revisit intention. To improve Malaysian tourism, the tourism ministry, tourism players, and tourism agencies should collaborate to achieve memorable memories, high traveller satisfaction, and to meet tourist expectations. The tourism service and attractions must be in high condition, 5 star rated, and full of originality in order to attract local and international tourists who will revisit intention. Future studies should prioritise a well-balanced population sample. An unbalanced sample would result in inconsistencies in the results, favouring just one group. Then, in order to get precise, accurate, and consistent results, the sample size should be increased. Future research may also look into including additional factors to find more traits that encourage tourists to return to the same locations. Knowing additional elements that influence tourist return intention aided the tourism sector in upgrading its amenities in order to attract tourists and expand the tourism sector.

## REFERENCES

- Abenoza, R. F., Cats, O., & Susilo, Y. O. (2018, February 8). *How does travel satisfaction sum up? an exploratory analysis in decomposing the door-to-door experience for multimodal trips - transportation*. SpringerLink. <https://link.springer.com/article/10.1007/s11116-018-9860-0>
- Akter, M., Sadekin, M. N., & Patwary, A. K. (2020). An Empirical Study on Students' Satisfaction from Mawlana Bhashani Science & Technology University, Bangladesh. *Review of Economics and Development Studies*, 6(2), 363-379.
- Al Mahmud, S. R. (2020). The effectiveness of Facebook advertisements on purchase intention of customers in Malaysia. *South Asian Journal of Social Sciences and Humanities*, 1(1), 97-104.
- Alom, S., Patwary, A. K., & Khan, M. M. H. (2019). Factors affecting the turnover intention of Bangladeshi migrants in the United Arab Emirates: An empirical study on the hotel industry. *International Journal of Innovation, Creativity and Change*, 8(3), 344-360.
- Bayih, B. E., & Singh, A. (2020, September 18). *Modeling domestic tourism: Motivations, satisfaction and tourist behavioral intentions*. Heliyon. <https://www.sciencedirect.com/science/article/pii/S2405844020316820>
- Chan, T. (2020, October 31). *Memorable tourism experiences of international students and the potential for destination loyalty: A case study in New Zealand*. University of Otago Master's thesis. [https://www.academia.edu/44406189/Memorable\\_Tourism\\_Experiences\\_of\\_International\\_Students\\_and\\_The\\_Potential\\_for\\_Destination\\_Loyalty\\_A\\_Case\\_Study\\_in\\_New\\_Zealand](https://www.academia.edu/44406189/Memorable_Tourism_Experiences_of_International_Students_and_The_Potential_for_Destination_Loyalty_A_Case_Study_in_New_Zealand)
- Cho, K. W. (2022, October 1). *A review of memorable experiences and their implications for Tourism Experiences in Management and Marketing Science*. Mondes du Tourisme. <https://journals.openedition.org/tourisme/5053>
- Ćulić, M., Vujičić, M. D., Kalinić, Č., Dunjić, M., Stankov, U., Kovačić, S., Vasiljević, Đ. A., & Anđelković, Ž. (2021, May 21). *Rookie tourism destinations-the effects of attractiveness factors on destination image and revisit intention with the satisfaction mediation effect*. MDPI. <https://www.mdpi.com/2071-1050/13/11/5780>
- Fengmin, Z., Baijun, W., Jiangtao, B., Li, L., & Patwary, A. K. (2022). Investigating revisit intention of medical tourists in China through nutritional knowledge, perceived medical quality, and trust in the physiologist: A recommendation on health tourism policy measures. *Frontiers in Public Health*, 10, 893497.
- Franklin, A. (2023, April 12). *What is customer satisfaction? definition + importance*. Zendesk. <https://www.zendesk.com/blog/3-steps-achieving-customer-satisfaction-loyalty/>
- Hazbar, A. M. H., Alem Mohammed, A., & Karim, A. K. A. (2019). An Empirical Study of Factors Influencing hotel customers' online booking Intention. *مجلة العلوم التربوية و الدراسات الإنسانية*, (5), 1-17.
- Hosany, S., Sthapit, E., & Björk, P. (2022). Memorable tourism experience: A review and research agenda. <https://onlinelibrary.wiley.com/doi/full/10.1002/mar.21665>
- Jebbouri, A., Zhang, H., Wang, L., & Bouchiba, N. (2021, November 23). *Exploring the relationship of Image Formation on tourist satisfaction and loyalty: Evidence from China*. *Frontiers in psychology*. <https://www.ncbi.nlm.nih.gov/pmc/articles/PMC8649662/>

- Kane, L. (2018). *The peak–end rule: How impressions become memories*. Nielsen Norman Group. <https://www.nngroup.com/articles/peak-end-rule/>
- Li, L., Ragavan, N. A., Patwary, A. K., & Baijun, W. (2022). Measuring patients' satisfaction toward health tourism in Malaysia through hospital environment, nutritional advice, and perceived value: A study on Chinese exchange students. *Frontiers in public health*, 10, 893439.
- Li, L., Wu, B., & Patwary, A. K. (2022). How marine tourism promote financial development in sustainable economy: new evidences from South Asia and implications to future tourism students. *Environmental Science and Pollution Research*, 29, 1155-1172.
- Li, L., Wu, B., & Patwary, A. K. (2022). The psychosocial factors affecting chinese Outbound Exchange and mobility students' academic performance during COVID-19. *Frontiers in psychology*, 13, 872516.
- Lu, Y., Lai, I. K. W., Liu, X. Y., & Wang, X. (2022, September 16). *Influence of memorability on revisit intention in welcome back tourism: The mediating role of nostalgia and destination attachment*. *Frontiers*. <https://www.frontiersin.org/articles/10.3389/fpsyg.2022.1020467/full>
- Nasir, M. N. M., Mohamad, M., & Izzati Ab, N. (2021). Understanding the behaviour of international tourists from china visiting Malaysia: Proposing a conceptual model. *Journal of Marketing Advances and Practices*, 3(2), 1-16.
- Patwary, A. K., Roy, B., Hoque, R., & Khandakar, M. S. A. (2019). Process of developing a community based tourism and identifying its economic and social impacts: An Empirical study on Cox's Bazar, Bangladesh. *Pakistan Journal of Humanities and Social Sciences*, 7(1), 1-13.
- Rangaiah, M. (2021). *5 factors influencing consumer behavior*. Analytics Steps. <https://www.analyticssteps.com/blogs/5-factors-influencing-consumer-behavior>
- Rasoolimanesh, S. M., Seyfi, S., Hall, C. M., & Hatamifar, P. (2021, May 25). *Understanding memorable tourism experiences and behavioural intentions of Heritage Tourists*. *Journal of Destination Marketing & Management*. <https://www.sciencedirect.com/science/article/pii/S2212571X2100069X>
- Sumethokula, P., Patwary, A. K., Srinuanpanc, B., Srinuanpand, C., Suwandee, P., Thammathikulf, A., & Phanong, W. (2020). The potential of new tour repackaging for creative tourism among entrepreneurs in Nakhon Si Thammarat. *International Journal of Innovation, Creativity and Change*, 13(10), 1752-1771.
- Torabi, Z.-A., Shalbfafian, A. A., Allam, Z., Ghaderi, Z., Murgante, B., & Khavarian-Garmsir, A. R. (2022, February 25). *Enhancing memorable experiences, tourist satisfaction, and revisit intention through Smart Tourism Technologies*. MDPI. <https://www.mdpi.com/2071-1050/14/5/2721>
- Wu, B., Liu, S., Wang, J., Tahir, S., & Patwary, A. K. (2021). Assessing the mechanism of energy efficiency and energy poverty alleviation based on environmental regulation policy measures. *Environmental Science and Pollution Research*, 28, 40858-40870.
- Wu, B., Zhai, B., Mu, H., Peng, X., Wang, C., & Patwary, A. K. (2021). Evaluating an economic application of renewable generated hydrogen: A way forward for green economic performance and policy measures. *Environmental Science and Pollution Research*, 1-15.
- Yang, W., Zhang, Y., & Wang, Y.-C. (2022). Would travel experiences or possessions make people happier? <https://journals.sagepub.com/doi/abs/10.1177/00472875211064631?journalCode=jtrb>

# **The Relationship Between Accommodation, Food Quality, and Customer Relations Towards Tourist Satisfaction in Malaysia**

**Mohamad Alliff Bin Che Rahim, Mohamad Israfael Bin Mokhtar, Mohamad Nor Afiq Bin Mohd Nor Khalid, Mohd Shafiq Ikhwan Bin Maida & Marlisa Abdul Rahim**

*Faculty of Hospitality, Tourism and Wellness, Universiti Malaysia Kelantan*

marlisa@umk.edu.my

## **ABSTRACT**

Tourist satisfaction measurement has become an important issue in the tourism industry because this industry necessitates a high level of interaction between contact personnel (frontline employees) and tourist, and because quality perceptions are primarily based on the performance of subjective (intangible) criteria. Thus, the amount of satisfaction with services provided by tourists may have a direct towards on the level of satisfaction with services provided by tourists. The purpose of this study is to assess the relationship between accommodation, food quality, customer relations and tourist satisfaction. The debate is based on the findings of a study of Malaysian tourists. The purpose of this research is to examine the relationship of accommodation, food quality, and customer relations between tourist satisfaction among local tourist in Malaysia. It is discovered accommodation, food quality, and customer relations were that affected tourist satisfaction among local tourist in Tourism Industry Malaysia. The local tourist around the Peninsular of Malaysia were targeted respondents and a total of 256 respondents were successfully responded through the online survey. Data collected was analysed by using Statistical Package for Social Science (SPSS) version 29.0.

***Keywords:*** Tourist Satisfaction, Tourism Industry, and Local Tourist.

---

## **INTRODUCTION**

Many countries rely on this thriving industry for money, jobs, private-sector growth, and infrastructure development. Tourism expansion is encouraged in developing countries when manufacturing or natural resource exporting are financially unfeasible.

There are various and diverse reasons why people wish to travel. The rising ease of access to the many components of the travel experience has led to tourism's fast development in a short period of time. Many countries now offer affordable transportation to, from, and within previously inaccessible regions. Major cities, resort areas, near airports and major thoroughfares, and rural areas offer high-quality lodging and food at various prices. The contemporary travel industry owes its ability to provide secure, agreeable, and gratifying travel experiences to

proficient travel enterprises and excursion organisers, promotional efforts by governmental tourism bureaus, and state-of-the-art technological advancements that expeditiously link tourism elements for prospective voyagers.

This study investigates the link between tourist satisfaction and accommodation, food quality, and customer relations. The growing prosperity of nations such as Taiwanese, S. Korea, and Malaysia, as well as the vast populations of China, India, and Indonesia, are driving the rapid growth of tourism in Asia. Verdict provides the top five tourism locations in Asia Pacific in 2022, according to Global Data, based on tourist arrivals, traveler demand, and flow databases.

According to Global Data, in 2022, China will receive 43.4 million international tourists, making it the most popular destination in Asia. According to Global Data's traveler demands and flows database, Hong Kong, Macao, and Taiwan are forecast to be China's most important source markets in 2022. According to Global Data's 2022 travelers demands and flows database, 26.6 million tourists will visit Thailand, the second-most popular Asia Pacific destination. Global Data predicts that China, Malaysia, and India will be the most significant source markets for the destination.

There are three objectives of this research:

1. To investigate the link between accommodation and tourist satisfaction in Malaysia.
2. To examine the connection between food quality and tourist satisfaction in Malaysia.
3. To examine the link between customer relations and tourist satisfaction in Malaysia.

## **SIGNIFICANCE OF THE STUDY**

### **Researchers**

The study's outcome will aid researchers in assessing the correlation between three factors - accommodation, food quality, and customer relations - and the satisfaction of local tourists in Malaysia. The findings of this study will assist researchers in gaining a better understanding of the factors that impact the satisfaction of local tourists with e-hailing services.

### **Owners**

This study aims to gather information on individuals' satisfaction with services. This study aims to evaluate the quality of accommodation, food, and customer relations to understand the types of behaviours that may arise when using these services. It is important to understand the behaviour of customers and their decision-making process when using services, whether as individuals or as a group. Gathering data will help owners understand the factors that influenced their purchase of a service.

**Tourism sector**

The data will provide valuable insights to the tourism sector regarding how people make decisions when purchasing tourism products and services, as well as the factors that can influence their decision-making process. The outcome will allow the tourism sector to enhance their management and effectively convince people to buy their tourism services. These studies help the tourism sector understand what factors are important in making usage decisions. This study contributes to the development of tourism planning.



## **LITERATURE REVIEW**

### **Accommodation**

Accommodation pertains to the various lodging options that are accessible to tourists, such as hotels, motels, resorts, bed and breakfasts, and vacation rentals. The standard of lodging can greatly influence the overall experience of a tourist. Tourists are more likely to have a positive experience if the accommodations are clean, comfortable, and well-maintained. Conversely, if the lodging is unclean, uncomfortable, or inadequately maintained, it is probable that travellers will have an unfavourable experience (Gerwe et al., 2021).

Accommodation is supplied to meet the needs of tourist who are traveling, such as a place to stay or a temporary dwelling. Tourist accommodation is made up of two distinct components. Supply and demand are the two components. It demonstrates that tourist accommodation relates to who provides services to tourists or tourism customers (Silaban et al., 2019).

### **Food Quality**

It is important to emphasise that food and drinks are essential components that tourists must consume. The quality of food can potentially enhance a tourist's interest in a particular location and prompt them to reevaluate their selection criteria. It has been discovered that the quality of food is a determining factor in the perceived value of tourism. This is because food quality affects not only tourist satisfaction, but also other aspects related to it (Richards et al., 2021).

The important factor in tourist satisfaction is the variety and quality of food provided by fast food businesses. Price and product quality are two criteria recognized as related to tourist satisfaction. Food quality towards tourist impressions of food and their purchasing decisions. The quality of food has been identified as the most important factor in determining the ratings of different types of establishments by tourists. To ensure that the expectations of tourists are met and that they are satisfied, it is essential to use high-quality food (Uslu et al., 2020).

### **Customer Relations**

Customer relations are also a critical aspect of the tourism industry. Effective communication, responsiveness to customer needs, and providing a personalized experience can help create loyal customers who return time and again. Having staff members who are friendly, knowledgeable, and responsive to customers' needs can greatly contribute to establishing a positive reputation for a business. Establishing strong customer relationships can result in favorable reviews and recommendations, ultimately drawing in new customers (Stojiljkovi et al., 2019).

As the growth of tourism and customer relations has become a crucial aspect for all businesses, the marketing approach of customer relationship development has been extensively researched. The absence of hesitancy in delivering positive feedback to a product, the preservation of client connections, the convenience of sale, and the speed with which items are promoted all indicate a tourist loyalty to that product (Pambudi et al., 2021).

## **Tourist Satisfaction**

The concept of tourism is commonly used in tourism marketing literature (Nasir et al., 2021). Definition of Tourist satisfaction Tourist satisfaction pertains to the degree of gratification or satisfaction that a tourist encounters during their travel experience. It is a subjective evaluation of the overall experience, including various factors such as accommodation, transportation, attractions, food, and customer service. The satisfaction of tourists is influenced by their expectations before travelling, the actual experience they have during their trip, and the comparison they make between the two. Tourist satisfaction is an essential measure of the success of the tourism industry, as it can impact tourists' decision to return to a destination or recommend it to others (Pai et al., 2020).

Accommodation is an essential element of a tourist's overall travel experience and can significantly impact their level of satisfaction. Room Quality. The quality of the room is a crucial factor that can significantly impact a tourist's satisfaction level. The level of cleanliness, comfort, size, and available amenities in a room can significantly affect a tourist's overall satisfaction. Staff Service. The staff's quality of service is also a crucial antecedent of tourist satisfaction. Friendly and helpful staff can make a significant difference in a tourist's experience, while rude or unhelpful staff can leave a negative impression (Nisar et al., 2020).

### **The relationship between accommodation, food quality, and customer relations toward tourist satisfaction in Malaysia**

The correlation between accommodation and tourist satisfaction. The location of accommodation can also impact tourist satisfaction. Tourists may be more satisfied if their accommodation is conveniently located near tourist attractions or other amenities. Tourist satisfaction is the level of service provided by accommodation providers. Friendly and helpful staff, personalized attention, and efficient check-in and check-out processes can all contribute to a positive experience for tourists. On the other hand, poor service, rude staff, or long wait times can lead to dissatisfaction. The quality of accommodation can have a significant impact on tourist satisfaction. Tourism businesses should prioritize high-quality accommodation and customer service to ensure that tourists have positive experiences and are more likely to return in the future (Biswas et al., 2020).

The correlation between accommodation and tourist satisfaction. The quality of food is a crucial aspect that can significantly affect the satisfaction of tourists, especially in the tourism industry. Tourists often seek out local cuisine and dining experiences as an important part of their travel experience, and the quality of food and dining options can influence their overall satisfaction with their trip. When tourists have access to high-quality food options that meet their expectations, they are more likely to have positive feelings about their destination and their trip. Good quality food can enhance the overall experience of travel and create lasting memories for tourists (Kala et al., 2020).

The correlation between accommodation and tourist satisfaction. Effective customer relations can also impact tourist satisfaction in other ways. For example, businesses that actively seek feedback from customers and make changes based on that feedback are more likely to meet customers' needs and expectations, leading to increased satisfaction. Likewise, offering personalized experiences and creating a sense of community can help tourists feel valued and appreciated, which can contribute to higher levels of satisfaction (Khan et al., 2022).

## Research Hypothesis

For a hypothesis to be considered valid, it must be both testable and realistic, while also considering current knowledge and methodologies. A hypothesis is a prediction or explanation of a relationship between two variables. It suggests that an independent variable and a dependent variable have a systematic connection. As a result, the research suggests:

H1: There is a relationship association between accommodation and tourist satisfaction.

H2: There is a relationship Food quality correlates positively with tourist satisfaction.

H3: There is a relationship Customer relations correlate positively with tourist satisfaction.

## Conceptual Framework

The conceptual framework for this research is seen in Figure 2.1. The three factors that make up the independent variable that will be proposed are accommodation, food quality, and customer relations. Local tourist satisfaction in Malaysia is the dependent variable.

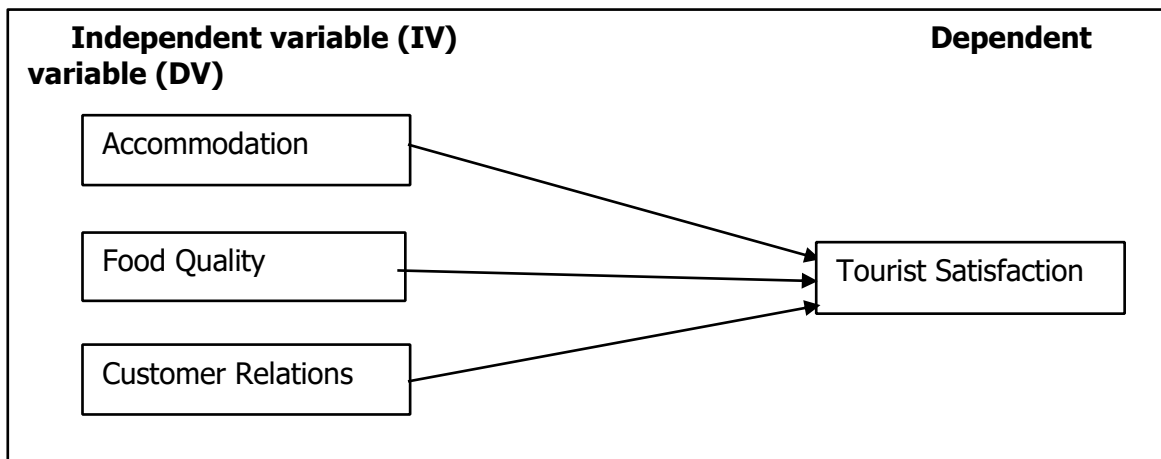

Figure 2.1: Conceptual Framework of accommodation, food quality, and customer relations toward Tourists' Satisfaction.

## METHODOLOGY

### Research Design

The study's design incorporates the factors that impact tourist satisfaction among local tourist in Malaysia. A quantitative technique will use in this study, and data will collect from individuals using a self-directed questionnaire. The relationship between accommodation, food quality, customer relations, and tourist satisfaction among local tourist in Malaysia is the subject of a descriptive study. The descriptive study design assists in answering the research questions and achieving the research objectives.

### Population and sample size

Overall, the population including the international and domestic tourist is 231.3 million. The research population of this study only involves local tourist in Malaysia. The target population for local tourist is 131.66 million. To determine the sample size, Krejcie and Morgan (1970) sample was used in this study. Krejcie & Morgan (1970):

S = sample size

$X^2$  = the table value of chi-square for 1 degree of freedom at the desired confidence level (3.841) N = the population size of domestic tourist in a year

P = the population proportion (assumed to be 0.5 since this would provide the maximum sample size)

d = the degree of accuracy expressed as a proportion (0.5)

$$S = \frac{x^2NP(1-P)}{d^2(N-1) + (x^2P(1-P))}$$
$$S = \frac{3.841(2054000000)(0.5)(1-0.5)}{(0.05)^2(2054000000-1) + 3.841(0.5)((1-0.5))}$$
$$S = \frac{1972353500}{5135000.958}$$

$$S = 384.099$$

$$S = 384$$

The exact amount of sample size for the population are 384 but the return of the questionnaire answered by respondents collected the data for 256 respondents.

## **Data Collection**

The data collection method utilised in the initial stage of this study involved online surveys administered through Google Forms. The researcher chose to use this platform of technology tools because it is both free and user-friendly. It also makes it easier for the researcher to collect all the data from tourists who are local to the area. The second stage of data collection involved conducting fieldwork. The questionnaire was utilised as the primary instrument for data collection in this study. There are six sections in the questionnaire that require respondents to provide answers. A questionnaire was distributed among the local tourists in Malaysia to collect data.

## **Sampling**

Csikszentmihalyi et al., (2014) Sampling is a technique for obtaining data in academics to learn regarding a particular population by studying the findings of a sample of people rather than focusing on some specific individuals. Probability sampling and non-probability sampling are the two major sample methodologies used in this study. Random samples are used in probability sampling, enabling important inferences more about overall demography to be drawn. Non-probability sampling is frequently related with qualitative research and the construction of research articles. The non-probability approach, for example, a simple sampling method, was chosen as the sample design in this investigation. Facility sampling is a sampling strategy that involves selecting participants from a target group based on specific criteria, such as accessibility, geographic location, capacity at a given time, or willingness to participate. This method is non-probability or non-random in nature.



## Research Instrument

The items measuring the chosen research constructs were adopted from prior related research in the field of tourism consumer behaviour.

Table 1: Measurement items

Measurements	Number of items in the questionnaires	Scales used	Author
Section A: Demographic information	6	Adapt	
(Dependent Variables) Section B: Tourist satisfaction	5	Adopt	Khan et al., (2020)
(Independent Variables) Section C: Customer Relations	5	Adopt	Stojiljkovi et al., (2019)
(Independent Variables) Section D: Food Quality	5	Adopt	Jeaheng et al., (2020)
(Independent Variables) Section E: Accommodation	5	Adopt	Gössling et al., (2021)
Total	26		

## Data Analysis

The primary data will be examined by researchers using the Statistical Programmers for Social Science (SPSS) version 29.0. SPSS is a program-based data processing and analysis window that allows you to create tables and pie charts. Computers aided researchers in lowering the effort required to determine information and making quantitative analysis easily and quickly. The researcher uses descriptive statistics, reliability statistics, Pearson's correlation, and regression to evaluate quantitative data.

## FINDINGS

### Demographic Profile of Respondent

### Research Instrument

The items measuring the chosen research constructs were adopted from prior related research in the field of tourism consumer behaviour.

Table 1: Measurement items

Measurements	Number of items in the questionnaires	Scales used	Author
Section A: Demographic information	6	Adapt	
(Dependent Variables) Section B: Tourist satisfaction	5	Adopt	Khan et al., (2020)
(Independent Variables) Section C: Customer Relations	5	Adopt	Stojiljkovi et al., (2019)
(Independent Variables) Section D: Food Quality	5	Adopt	Jeaheng et al., (2020)
(Independent Variables) Section E: Accommodation	5	Adopt	Gössling et al., (2021)
Total	26		

Table 2: Demographic Profile of Sample

Characteristics	Frequency	%	
Gender	Male	91	35.55
	Female	165	64.2
Age	18-20 years old	15	6.4
	21-30 years old	115	45.1
	31-40 years old	95	36.2
	41-50 years old	28	10.9
	51 and above	3	1.4
Race	Malay	157	61.4
	India	68	26.5
	Chinese	31	12.1
Occupation	Student	91	35.7
	Governments	13	5.1
	Private Sector	129	50.3
	Freelancer	8	3.1
Travel Frequencies	Self-employed	15	5.8
	1-2 Times	78	30.4
	3-5 Times	113	44
Travel Period	More than 5 Times	65	25.6
	Public Holiday	108	42.4
	Semester Break Weekends	42	17.9
	Anytime	102	39.7

The respondent profile is summarized in Table 2. The total number of respondents for male was 91 respondents while the number of females was 165 respondents. The highest percentage of respondents was age from 21-30 years old which have (45.1%), second highest is the age range 31-40 which have (36.2%), third is 41-50 years' old which has (10.9%), fourth is 18-20 years old which was (6.4%), and the last is age range below 50 years' old and above which have (1.4%).

There were 256 respondents who consist of Malay (157 respondents), India (68 respondents), and Chinese (31 respondents) had responded to the questionnaire. The highest percentage of respondents was Malay (61.4%) and follow by Indian respondents which have 26.5%, third is Chinese respondents who have 12.1%.

Next, the total number of respondents for student was 91 respondents and 35.7%, the respondent for governments was 13 respondents and 5.1%. The questionnaire was completed by 3.1 % of those is freelancer (8 respondents). 5.8 % (15 respondents) of self-employed have responded. The highest respondents were 50.3 % (129 respondents) is private sector.

Furthermore, there were 30.4 % (78 respondents) who had travel frequencies for 1-2 times who answered the questionnaires. The highest were 44 % (113 respondents) who had travel more, and the lowest were 25.6 % who had travel is (65 respondents). Moreover, public holiday had the greatest percentage of responders (42.4%). (108 respondents). The questionnaire was completed by anytime travel period by 39.7% (102 respondents). Semester break weekends had the lowest participation rate, at 17.9 % (45 respondents).

## Reliability Test

A reliability system is used to assess a system's overall stability and performance over a particular period and under various testing situations. The pilot test was conducted with 30 people before being circulated to 256 people via an internet survey.

Table 3: Results of Reliability Test

Variable	Number of items	Cronbach's Alpha coefficient	Strength of Association
Accommodation	5	0.905	Excellent
Food Quality	5	0.917	Excellent
Customer Relations	5	0.904	Excellent
Tourist Satisfaction	5	0.905	Excellent

Cronbach's Alpha Coefficient values for the independent and dependent variables in this study are shown in Table 3. We may deduce from the table above that all the variables were more than 0.9. Consequently, the conclusion presented is reliable and may be accepted in this study. The accommodation variable that impacted tourist satisfaction among local tourists in Malaysia was measured using 5 questions, and the Cronbach's Alpha result for this section's question was 0.905, which was excellent. As a result, the coefficients derived for the accommodation variable questions were reliable.

Following that, there were five questions in assessing the food quality variable that affected tourist satisfaction among local tourist in Malaysia, and the result was 0.917, which is considered excellent. As a result, the coefficients calculated for the food quality variables were reliable.

Five questions were utilised to measure the dependability variable that affected customer relations among local tourist in Malaysia, and the outcome for this section's question was 0.904, which was outstanding. As a result, the coefficients produced for the reliability variable questions were reliable.

Finally, five questions were utilised to assess tourist satisfaction among local tourist in Malaysia, and the Cronbach's Alpha result for this section's question was 0.905, indicating excellent. As a result, the coefficients derived for these questions in assessing tourist satisfaction among local tourist in Malaysia were also reliable. Since the Cronbach's Alpha charge for the variables exceeded 0.7, it may be concluded that surveys are extremely trustworthy and that the study can proceed.

## Descriptive Analysis

This study has analysed the mean and standard deviation for section C, D, E and F of the questionnaires.

Table 4: Descriptive Statistics

Variables	N	Mean	Standard Deviation
Accommodation	256	8.9695	1.42030
Food Quality	256	7.8672	1.65859
Customer Relations	256	9.0977	1.15904
Tourist Satisfaction	256	8.2695	1.42030

Table 4 displays on the independent variable and dependent variable, the mean and standard deviation analysis. Accommodation factor, food quality factor, and customer relations factor was independent variable while dependent variable was tourist satisfaction among local tourist in Malaysia. The highest mean value was customer relations, which is 9.0977, where respondents agreed more on this factor. Meanwhile, the lowest mean value was food quality factor, which is only 7.8672, where in this study the respondents agreed lower for that variable. The data set with the standard deviation of more than 1 out of 256 respondents shows the more dispensing values.

## Pearson Correlation

One of the most important analyses that examined the linear relationship between the two variables was Pearson's correlation analysis. The goal of this study was to see if there were any relationships between the independent variables (accommodation, food quality, and customer relations) and the dependent variable (tourist satisfaction). If the relationship is substantial, the researchers must determine what degree of association strength is acceptable.

## Hypothesis 1

H<sub>1</sub>: There is relationship between accommodation factors and tourist satisfaction among local tourist in Malaysia.

Table 5: Correlation coefficient for accommodation factors and tourist satisfaction local tourist in Malaysia.

		Tourist Satisfaction		Accommodation	
Tourist Satisfaction	Pearson correlation	1		0.752**	
	Sig. (2-tailed)			0.000	
	N	256		256	
Accommodation	Pearson correlation	0.752**		1	
	Sig. (2-tailed)	0.001			
	N	256		256	

Table 5 shows the Pearson correlation coefficient, the significant value, and the total number of respondents (256). The p-value was 0.001, which was the same with the 0.01 level of significance. The accommodation and tourist satisfaction exhibited a high positive link with a correlation value of 0.752.

## Hypothesis 2

H<sub>2</sub>: There is relationship between food quality factors and tourist satisfaction among local tourist in Malaysia.

Table 6: Correlation coefficient for food quality factors and tourist satisfaction among local tourist in Malaysia.

		Tourist Satisfaction		Food Quality	
Tourist Satisfaction	Pearson correlation	1		0.778**	
	Sig. (2-tailed)			0.000	
	N	256		256	
Food Quality	Pearson correlation	0.778**		1	
	Sig. (2-tailed)	0.000			
	N	256		256	

Table 6 shows the Pearson correlation coefficient, the significant value, and the total number of instances (256). The p-value was 0.001, which was same with the 0.01 level of significance. The correlation value of 0.778 revealed a high positive relationship between food quality and tourist satisfaction.

### Hypothesis 3

H<sub>3</sub>: There is relationship between customer relations and tourist satisfaction among local tourist in Malaysia.

Table 7: Correlation coefficient for customer relations and tourist satisfaction among local tourist in Malaysia.

		Tourist Satisfaction	Customer Relations
Tourist Satisfaction	Pearson correlation	1	0.826**
	Sig. (2-tailed)		0.001
	N	256	256
Customer Relations	Pearson correlation	0.826**	1
	Sig. (2-tailed)	0.001	
	N	256	256

Table 7 shows the Pearson correlation coefficient, significant value, and case count of 256. The p-value was 0.001, which was same with the 0.01 level of significance. With a correlation value of 0.826, there was a high positive link between customer relations and tourist satisfaction.

Table 8: Summary of Correlation Analysis

Hypothesis	Significant Value	Conclusion	Correlation Value	Conclusion
1	0.001	Accepted	0.752	High Positive
2	0.001	Accepted	0.778	High Positive
3	0.001	Accepted	0.826	High Positive

Researchers used Correlation Analysis to determine the linear relationship between the two variables that were indicated as the study's goals. Table 8 shows the results of the Correlation Analysis, which revealed a strong positive association between accommodation, food quality, and customer relations. In addition, there is a strong link between accommodation, food quality, customer relations among local tourist in Malaysia.

## **DISCUSSION & RECOMMENDATION**

The study analysing the relationship between accommodation, food quality, customer relations, and tourist satisfaction. The purpose of this study is to determine the relationship between accommodation, food quality, customer relations, and tourist satisfaction among local tourists in Malaysia.

This study suggests that more research on local tourist travel in Malaysia conducted, because this research was limited to Malaysian visitors, it was unable to draw any conclusions. The results of this study may differ if it is extended to international visitors in Malaysia. As a result, instead of focusing just on local tourists, other tourists were otherwise expected to answer out surveys.

Additionally, this study solely considers of three characteristics that influence tourist satisfaction with accommodation, food quality, customer relations, among local tourist in Malaysia. Nevertheless, this study may be overlooking other crucial aspects that impact tourist satisfaction among local tourist in Malaysia. Consequently, future researcher's may propose additional variables, such as transparency factors, to test their new discovery.

The study is then reduced to 256 samples, which may be utilised to define the target population. According to Krejcie and Morgan (1970), if the amount is sufficiently reliable, higher sample sizes might be applied to analyse millions of Malaysian tourists. Consequently, to improve the validity and reliability of their investigations, future researchers should raise their sample size.

Furthermore, rather than respondent responding a scale online survey questionnaire, uses an interview method construct open-ended questions to respondents. Researchers may receive a high interview response rate, and uncertainties or partial answers can be pursued on straight away. Consequently, these strategy will eliminate misunderstanding and considerably to improve study findings.

Finally, future researchers should be undertaken to remain up to date on variables that might impact tourist satisfaction with accommodation, food quality, and customer relations. It is feasible to assess the factors that influence tourist satisfaction, which may assist business owners in implementing more successful marketing tactics. Academics in the future might create a unique framework for analysing tourist satisfaction with tourism industry. Because client happiness with e-hailing services is variable, regional surveys must be conducted to measure customer satisfaction.



## CONCLUSION

In conclusion, the researcher must clearly state the study's goal in relation to this chapter's problem. This study investigates how accommodation, food quality, and customer relations impact the satisfaction of local tourists in Malaysia. The research framework has been developed based on the literature that has been reviewed. The researcher wanted to see how each element related in the dependent variables and the independent variables.

This research examines the correlation between accommodation, food quality, and customer relations and how they impact the level of satisfaction among local tourists in Malaysia. Research goals have been accepted, it's aimed to examine the relationship between accommodation, food quality, and customer relations that influence tourist satisfaction among local tourists in Malaysia. The joy of local tourists in Malaysia can be affected by factors such as accommodation, food quality, and customer relations. Predictions can be made about the impact of these factors on tourist satisfaction.

## REFERENCES

- Akter, M., Sadekin, M. N., & Patwary, A. K. (2020). An Empirical Study on Students' Satisfaction from Mawlana Bhashani Science & Technology University, Bangladesh. *Review of Economics and Development Studies*, 6(2), 363-379.
- Alom, S., Patwary, A. K., & Khan, M. M. H. (2019). Factors affecting the turnover intention of Bangladeshi migrants in the United Arab Emirates: An empirical study on the hotel industry. *International Journal of Innovation, Creativity and Change*, 8(3), 344-360.
- Biswas, C., Omar, H., & Rashid-Radha, J. Z. R. R. (2020). The impact of tourist attractions and accessibility on tourists 'satisfaction: the moderating role of tourists 'age. *Geo Journal of Tourism and Geosites*, 32(4), 1202-1208.
- Csikszentmihalyi, M., Csikszentmihalyi, M., & Larson, R. (2014). Validity and reliability of the experience-sampling method. *Flow and the foundations of positive psychology: The collected works of Mihaly Csikszentmihalyi*, 35-54.
- Fengmin, Z., Baijun, W., Jiangtao, B., Li, L., & Patwary, A. K. (2022). Investigating revisit intention of medical tourists in China through nutritional knowledge, perceived medical quality, and trust in the physiologist: A recommendation on health tourism policy measures. *Frontiers in Public Health*, 10, 893497.
- Gerwe, O. (2021). The Covid-19 pandemic and the accommodation sharing sector: Effects and prospects for recovery. *Technological Forecasting and Social Change*, 167, 120733.
- Hazbar, A. M. H., Alem Mohammed, A., & Karim, A. K. A. (2019). An Empirical Study of Factors Influencing hotel customers' online booking Intention. *مجلة العلوم التربوية و الدراسات الإنسانية*, (5), 1-17.
- Kala, D., & Barthwal, S. (2020). Exploring tourist satisfaction on food and restaurant experience in mountainous religious destinations. *International Journal of Tourism Policy*, 10(1), 1-22.
- Khan, R. U., Salamzadeh, Y., Iqbal, Q., & Yang, S. (2022). The impact of customer relationship management and company reputation on customer loyalty: The mediating role of customer satisfaction. *Journal of Relationship Marketing*, 21(1), 1-26.
- Krejcie, R. V., & Morgan, D. W. (1970). Determining sample size for research activities. *Educational and psychological measurement*, 30(3), 607-610.
- Li, L., Ragavan, N. A., Patwary, A. K., & Baijun, W. (2022). Measuring patients' satisfaction toward health tourism in Malaysia through hospital environment, nutritional advice, and perceived value: A study on Chinese exchange students. *Frontiers in public health*, 10, 893439.
- Li, L., Wu, B., & Patwary, A. K. (2022). How marine tourism promote financial development in sustainable economy: new evidences from South Asia and implications to future tourism students. *Environmental Science and Pollution Research*, 29, 1155-1172.
- Li, L., Wu, B., & Patwary, A. K. (2022). The psychosocial factors affecting chinese Outbound Exchange and mobility students' academic performance during COVID-19. *Frontiers in psychology*, 13, 872516.
- Nasir, M. N. M., Mohamad, M., & Izzati Ab, N. (2021). Understanding the behaviour of international tourists from china visiting Malaysia: Proposing a conceptual model. *Journal of Marketing Advances and Practices*, 3(2), 1-16.

- Nisar, T. M., Hajli, N., Prabhakar, G., & Dwivedi, Y. (2020). Sharing economy and the lodging websites: Antecedents and mediators of accommodation purchase intentions. *Information Technology & People*, 33(3), 873-896.
- Pambudi, A., Widayanti, R., & Edastama, P. (2021). Trust and Acceptance of E-Banking Technology Effect of Mediation on Customer Relationship Management Performance. *ADI Journal on Recent Innovation*, 3(1), 87-96.
- Patwary, A. K., Roy, B., Hoque, R., & Khandakar, M. S. A. (2019). Process of developing a community based tourism and identifying its economic and social impacts: An Empirical study on Cox's Bazar, Bangladesh. *Pakistan Journal of Humanities and Social Sciences*, 7(1), 1-13.
- Richards, G. (2021). Evolving research perspectives on food and gastronomic experiences in tourism. *International journal of contemporary hospitality management*, 33(3), 1037-1058.
- Silaban, P. H., Pasaribu, A., & Silalahi, A. D. (2019). The influence of human aspect of accommodation and destination on tourist satisfaction. *International Journal of Innovative Technology and Exploring Engineering*, 8(7), 985-995.
- Stojiljković, A. (2019). The impact of social media marketing on customer relationship development. *Journal of Process Management. New Technologies*, 7(3), 41-48.
- Sumethokula, P., Patwary, A. K., Srinuanpanc, B., Srinuanpand, C., Suwandee, P., Thammathikul, A., & Phanong, W. (2020). The potential of new tour repackaging for creative tourism among entrepreneurs in Nakhon Si Thammarat. *International Journal of Innovation, Creativity and Change*, 13(10), 1752-1771.
- Uslu, A., & Eren, R. (2020). Critical review of service quality scales with a focus on customer satisfaction and loyalty in restaurants. *Deturope-the Central European Journal of Regional Development and Tourism*, 12(1), 64-84.
- Wu, B., Liu, S., Wang, J., Tahir, S., & Patwary, A. K. (2021). Assessing the mechanism of energy efficiency and energy poverty alleviation based on environmental regulation policy measures. *Environmental Science and Pollution Research*, 28, 40858-40870.
- Wu, B., Zhai, B., Mu, H., Peng, X., Wang, C., & Patwary, A. K. (2021). Evaluating an economic application of renewable generated hydrogen: A way forward for green economic performance and policy measures. *Environmental Science and Pollution Research*, 1-15.

# **THE FACTORS INFLUENCE EMPLOYEE SATISFACTION EMPLOYEE SATISFACTION IN THE HOTEL INDUSTRY**

**MOHD AZMIER HAFIZ BIN LAMRI, MOHAMMAD AZAM BIN BORHAN, MOHD AMIN & MOHD HAFIZAN BIN ARSANI, \*MARLISA ABDUL RAHIM**

*Faculty of Hospitality, Tourism and Wellness, University Malaysia Kelantan*

marlisa@umk.edu.my

## **ABSTRACT**

The goal of this research is to investigate the relationship among reward, working conditions, motivation and employee satisfaction in the Malaysian hotel industry. It was discovered that reward, working conditions, and motivation all had an impact on employee satisfaction in Malaysian hotel industry while targeted 177 respondents proficiently finished that online survey. The details was evaluated via the Statistical Package for Social Science (SPSS) edition 24.0. SPSS Statistical covers the whole statistical evaluation approach to help make better decisions and perform better. Through the research, the Pearson correlation coefficient was utilised in order to explore the relationship among reward, working conditions, motivation, and employee satisfaction. The outcome shows the employee satisfaction has profound impact on hotel sector in Malaysia. This study can help to understand how reward, work conditions, and motivation affect employee satisfaction in the Malaysian hotel industry.

*Keywords : Job Satisfaction, Hotel industry and Employee.*

## **INTRODUCTION**

The tourism market is now recognised as an essential component for worldwide growth in society and the economy. (Wakimin et al., 2018). Based on Camilleri, (2018) defines tourism as provisional individuals that stay in another place from their house for at least a day if they plan to travel for leisure, wellness or vacation. Meanwhile, according to Chin (2020), tourism can classified as an influx of human beings over regions in search of unique natural as well as cultural pleasures. Also the other hand, The World Tourism Organization (UNWTO)(2021), defines tourism that includes any activities that include a person visiting and residing at a spot other than their customary residence for fewer than 12 months in consecutive years for enjoyment, work or other reasons. Moreover, tourism industry includes several other industries that offer services and products to both international and domestic tourists to fulfill their needs during their vacation such as accommodation, air, travel agencies, food and road passenger transport, and travel agencies (Nasir and Wongchestha, 2022).

Due to by Report of International Tourism Highlights (2019 Edition) on worldwide scale, the World Tourism Organization was signed up to 1.5 billion international tourist travel globally and demonstrates a 4% increase in stead of 2018. The extension of similarity was expected around 2020 (World Tourism Organization (UNWTO) World Tourism Barometer, 2020). However, Covid-19 pandemic's occurrences significantly altered the state of global tourism at this time. The epidemic had detrimental influence over tourism segments (Gössling and Scott, 2020) inevitably led to months of industrial shutdown. Although attempts have been made to restart the business, most of the sectors are still having trouble, with tourism being one of the most severely affected (Dolnicar & Zare, 2020). The World Travel & Tourism Council (WTTC) encourages the tourist industry to expand sustainably by collaborating with governments and international organizations to boost exports, build wealth to create employment again. Hence, tourism plays a significant role in a nation, community, economy, nature and environment, and the world (Horaira, 2020).

Malaysia's hotel industry is rising because of tourism increasing economic impact. (Shamsudin et al., 2019). In other countries where tourist customer service is also advanced, it is also a growing trend (Aldaihani & Ali, 2018). Aside from its Shariah-compliant Hotels (SCH), Malaysia is also well-known for its Muslim tourism from the Middle East (Haque et al., 2019). The hospitality industry is service-oriented and highly dependent on the actions and attitude of employees to offer the customer pleasant and friendly services. The workforce in hospitality was a primary resource in the industrial sector. Customer satisfaction can only be attained in a sector where services are highly individualized when staff members are content with their work. A study by the University of Warwick shows that happy and satisfied employees are 12 percent more productive than unhappy employees (Chowdhury, 2019). This happens because satisfied employees are more inclined to be working at the maximum level. In order to improve work pleasure and mitigate employee turnover intentions, hoteliers must better understand what inspires and satisfies their staff.

There are three objectives of this study:

1. To examine the relationship between reward and employees satisfaction in the hotel industry.
2. To examine the relationship between working conditions and employees satisfaction in the hotel industry.
3. To examine the relationship between the work motivation and employees satisfaction in the hotel industry.

## **SIGNIFICANCE OF THE STUDY**

### **Researchers**

The study's outcome will assist researchers in determining the link between three variables which is reward and employee satisfaction, working conditions and employee satisfaction and work motivation employee satisfaction hotel industry in Malaysia. The result will help researcher aspire to understand much about the variables that influence employees satisfaction in hotel segment in Malaysia.

### **Owners**

This research will assess a reward, working condition and also motivation factor to recognise the sorts of acts that can occur when use employee satisfaction. Get to know the behaviour of employee and the decision making when individual or group uses the employee satisfaction. The details acquired will conduct the proprietors in determining what elements have an impact employee satisfaction.

### **Tourism sector**

The information will provide insight the tourist segment exactly how customers opted to obtain tourism products and services. As a consequence, the tourist industry will be able to strengthen its administration in persuade individuals to obtain a employee satisfaction. These studies also make the tourism sector know what is important in the using decisions. In advance, through this type of research also contributes to the progress of tourist planning in future.

## **LITERATURE REVIEW**

### **Employee Satisfaction**

A key component of an organization's success is employee satisfaction (Amburgey 2005). This issue has piqued the interest of researchers worldwide as well as organization personnel (Lu et al., 2005). The major reason this subject has to be brought up is that an organization's success depends on its committed, devoted, motivated, and contented employees. They are among the key factors influencing an organization's performance.

According to Bushra (2011), when a worker is content with their job, they are satisfied with it. It is an admiring and fulfilling sensation that a person has as a result of their professional success (Belias et al., 2014). Employee satisfaction is necessary for the workforce since it indicates how each employee feels about their position (Raja et al., 2014).

It is thought that if job satisfaction is lacking, it will lead to unhappy employees who will be unable to place as much effort as they can (Muhammad et al., 2009). In short, employee satisfaction may be defined as the employee's favorable attitude about their employment.

### **Reward Factor**

Reward alludes to a range of benefits offered to employees, including both monetary and non-monetary (Armstrong, 2013). Total rewards are the term used to express an emphasis on the necessity of taking into account all aspects of job performance that are beneficial to employees. It seeks to combine the material and immaterial components of reward into a unified whole. Financial rewards include both person-based pay, which gives reward acknowledgment an individual's contributions and effort pay where it provides compensation linked to the worth of the task. (Armstrong, 2013). Non-financial rewards accentuate the varied degree to which people's desires for respect, accomplishment, room for personal development, and livable working circumstance (Armstrong, 2013).

### **Working Conditions Factor**

The working environment is determined by the standards set by the organization such as the workplace, equipment and collaboration among supervisor and coworkers. The atmosphere of the workplace has an influence on an employee's performance, protection, wellness, and psychological well-being. Comparing the workplace now to the past, it is distinct, diversified, and always evolving (Bhattacharjee et al., 2019). According to (Heap, 2001) shows that more than 90% of respondents said their attitude toward their job and mood are influenced by the setting they work.

## **Work Motivation Factor**

Motivation is determined by the passion or drives to achieve something, as well as the capacity to satisfy a few needs. Employers can motivate their employees by expanding the scope of the work and making it more intriguing, keeping them engaged, as well by improving their performance in the workplace. The achievement in achieving progressive targets and goals is probably one of the most crucial facets of their success. Motivation to work plays a central role in the presence of workers since they formulate the fundamental explanation of working for the duration of regulars day-to-day existence.

A high level motivation is an essential constituent of business exercises, whereby high motivation is correlated with work satisfaction, a sense of accomplishment and a profound attachment to the company, which affects performance and profit. "The predominance of the culture in the organisation has an enormous effect on motivating individuals in peak performance". (Garg & Rastogi, 2006). A Lean management approach would be very effective way to motivate all employees in an efficient manner.

### **The relationship between reward factor, working condition factor, motivation factor and employee satisfaction in hotel industry.**

Compensation and reward are critical components of Humans Resource Management. An organization remuneration scheme for tis personnel is crucial in determining employees commitment and retention. According to Wills (2001), the most important issues in attracting and retaining talent in organizations is compensation. As they compete for required skills and human capital, organisations, whether public or private, governmental or nonprofit, are implementing incentive practises. Bowen (2000) argued, in an era where accomplishing more with less is the norm, incentive and recognition are essential.

The outcome of working conditions on job satisfaction comprises two kinds of group workers: those who operate in an integrated environment and those who operate in tough situation. Only employees who meet specific requirements with condition of gender, age, health, qualifications, physical and mental condition capabilities are suited for tasks with challenging working conditions. As the consequence, it is critical to minimise hazardous working circumstances and if required to establish appropriate safety measures. This is to avoid tragedies and keep sure that working conditions are appropriate for workers right.

It contains a connection among motivation and job satisfaction, which serves as the cornerstone for every company existence. Peretomode (1991) stated that there are linked between job satisfaction and motivation but not like to synonymous terms. Job satisfaction is a component of the motivational procedure but motivation mostly focused goal of company, job satisfaction is concerned



with enlightenment of rewards and job tasks. It is also conceivable where worker appreciates all aspects of his work but is yet unmotivated. This implies denotes a high level of job satisfaction.

## Research Hypothesis

A hypothesis should be feasible, plausible, and also methodologies into account. Furthermore, a hypothesis is a forecast or justification of a link between variables. It suggests that an independent variable and a dependent variable have a systematic connection. As a result, the research suggests:

H1: There is a significant relationship between reward and employee satisfaction in hotel industry

H2: There is a significant relationship between working condition and employee satisfaction in hotel industry .

H3: There is a significant relationship between motivation and employee satisfaction in hotel industry

## Conceptual Framework

The conceptual framework for this research is seen in Figure 2.1. The three factors that make up the independent variable that will be proposed are reward, working condition, and motivation. Employee satisfaction is the dependent variable.

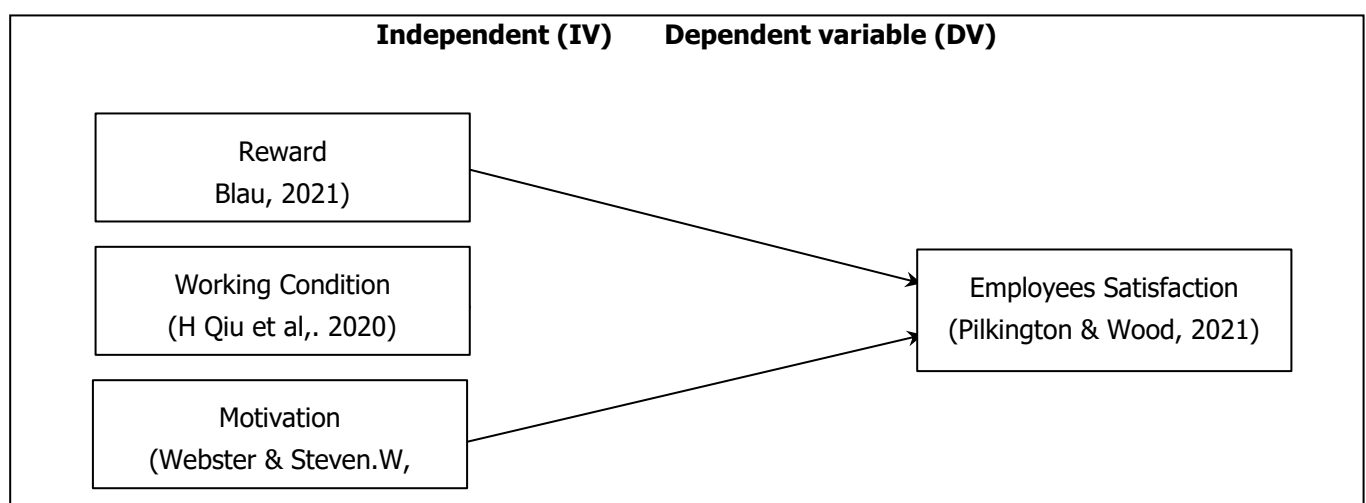

Figure 1: Conceptual Framework of the relationship among reward, working condition and motivation with employees satisfaction.



## METHODOLOGY

### Research Design

The study's design incorporates the factors that impact influence employee satisfaction among hotel industry in Malaysia. A quantitative technique will use through the research and details collected from individuals via self-directed questionnaire. The relationship between reward, working condition, and motivation among employee satisfaction is the subject of a descriptive study. The descriptive study design assists in answering the research questions and achieving the research objectives.

### Population and Sample size

Overall, the sample size is 177 employee. The population and sample size study only involves among employee hotel industry in Malaysia. The target population or employee is 177 respondent . To determine the sample size, Krejcie and Morgan (1970) sample was employed in this study.

S = sample size

$X^2$  = the table value of chi-square for 1 degree of freedom at the desired confidence level (3.841)

N = the population size of domestic tourist in a year

P = the population proportion (assumed to be 0.5 since this would provide the maximum sample size)

d = degree of accuracy expressed as a proportion (0.05)

$$S = \frac{\chi^2 NP (1 - P)}{d^2 (N - 1) + (\chi^2 P (1 - P))}$$

$$S = \frac{3841 (2054000000)(0.5)(1 - 0.5)}{(0.05)^2(2054000000 - 1) + 3.841 (0.5)(1 - 0.5)}$$

$$S = \frac{1972353500}{5135000.958}$$

$$S = 384.099$$

$$S = 384$$

The precise value of sample size for the population are 300 but the return of the questionnaire answered by respondents collected the data for 177 respondents.

## **Data Collection**

In the beginning phase, online surveys which is Google Form used to employed the data. The researcher utilised this structure of technological instruments because it is cost-free and straightforward to use. The fieldwork was the second phases of data gathering. Through this research, questionnaire was employed as the major source of information. The section has 6 components that declares ought to address. The questionnaire was handed out to the community, who are Malaysian tourists, with the desire to accumulate data.

## **Sampling**

Each population has a chance of being elite if the first type of sampling method mentioned above is used. It is primarily employed in quantitative research. Quantitative analysis and non-probability sampling methods will be used in this study. Rather than testing a hypothesis of a few large populations, the goal of these types of analyses is to develop a better understanding of a community (McCombes, 2021). Whatever method is used, the people chosen for a sample must be representative of the entire population. This could imply focusing on hard-to-reach demographics.

Probability sampling and non-probability sampling are the two sorts of sampling techniques. Begin with an entirely representative data set of everyone who is eligible from which to draw your possibility sample. For the outcome, the measurement error is unable to constructed and a remarkable risk of obtaining a non-representative sample with non-generalize results exists. In contrast, non-probability sampling is better for developing hypotheses and exploratory research more practical. The method of convenience sampling shall be employed through the research. Convenience sampling will assist researchers in data collection. It's the most commonly used sample technique because it's quick, easy, and inexpensive (Fleetwood, 2020). This method was chosen for this investigation because of the benefits and application of multiple sampling approaches in situations with large populations.

## Research Instrument

The substances applied to quantify the selected study components were taken from previous pertinent studies in the field of tourist purchaser habits

## Data Analysis

Researchers will use the programme Statistical Programmers for Social Science (SPSS)

Table 1: Measurement items			
Measurements	Number of items in the questionnaires	Scales used	Author
Section A: Demographic information	6		
(Dependent Variables) Section B: Employee satisfaction	5	Adopt	Pilkington & Wood (2021)
(Independent Variables) Section C: Reward	5	Adopt	Peter M. (2021)
(Independent Variables) Section D: Working Condition	5	Adopt	H. Qiu (2020)
(Independent Variables) Section E: Motivation	5	Adopt	Webster, Steven W (2018)
Total	26		

edition  
20.2 to  
consider  
the major

information. SPSS is a program-based data processing and analysis window that allows you to create tables and pie charts. Computers aided researchers in lowering the effort required to determine information and making quantitative analysis easily and quickly. The researcher uses descriptive statistics, reliability statistics, Pearson's correlation, and regression to evaluate quantitative data.

## FINDINGS

### Demographic Profile of Respondent

Table 2: Demographic Profile of Sample

Characteristics		Frequency	%
Gender	Male	56	31.5
	Female	122	68.5
Race	Malay	137	77
	Chinese	3	1.7
	Indian	14	14
	Others	24	13.5
Age	21-30 year old	174	97.8
	31-40 year old	4	2.2
	41-50 year old	0	0
	51 years old and above	0	0
Marital Status	Single	173	97.2
	Married	5	2.8
Education Level	Secondary School	3	1.7
	Diploma	7	3.9
	Bachelor of Degree	162	91
	Master Degree	6	3.4
	Doctor of Philosophy	0	0
Occupation	Employee	7	3.9
	Part time	0	0
	Unemployed	3	1.7
	Retired	1	0.6
	Student	167	93.8

Table 2 will illustrate the respondent description. Male replies totaled 56, while female respondents totaled 122. The survey received responses from Malay (137 respondents), Chinese (3 respondents), Indian (14 respondents), and others (24 respondents). The Malay had the biggest percentage of replies (77%), followed by others with 13.5%, Indians with 14%, and Chinese with just 1.7%. The largest proportion of respondents was in scale of age from 21-30 years old (97.8%) and the second highest is the range 31-40 years old which have 2.2%.

The complete amount of responders for single was 173 (97.2%) and married was 5 (2.8 %). The highest respondents were 91 % (162 respondents) with a bachelor's degree level of education, followed by 3.9 % (7 respondents) with diploma, third is Master of degree stated 3.4% (6 respondents) and the lowest proportion of respondents were those with a secondary school, which is 1.7 % (3 respondents).

Last but not least is students made up the bulk of respondents 93.8% (167 respondents), while the employees stated 3.9 % (7 respondents). There were 1.7 % (3 respondents) for unemployed and retired only 0.6% for 1 respondent

### Reliability Test

A reliability system is applied to gauge a system's entire resilience and efficiency beyond a specific time duration and across a variety of evaluation circumstances. It involved over 30 participants earlier than being distributed to 385 people by a digital survey which is Pilot Test.

**Table 3 : Result of Reliability Test**

Variable	Number of items	Cronbach's Alpha coefficient	Strength of Association
Employee satisfaction	5	0.820	Excellent
Reward	5	0.887	Excellent
Working condition	5	0.894	Excellent
Motivation	5	0.929	Excellent

Table 3 displays the Cronbach's Alpha Coefficient outcomes for independent and dependent variables in this research. We may deduce from the table above that all the variables were more than 0.8. As consequence, the offered conclusion is trustworthy and may be accepted in this probe. Employees satisfaction variable that influence employees satisfaction in the hotel industry was measured using 5 questions, and the Cronbach's Alpha outcome for this section query was 0.820,



which was excellent. For the outcome, the coefficients derived for employees satisfaction variable questions were reliable.

After that, five questions per section were submitted to analyze the incentive variables that affect employee satisfaction in the hotel business, and the results were for rewards (0.887), working conditions (0.894) and finally motivation (0.929). Every variable is considered excellent. Therefore, all the calculated coefficients are reliable.

### Descriptive Analysis

The mean and standard deviation for sections C, D, E, and F of the questionnaires were evaluated in this research.

Table 4: Descriptive Statistics

Variables	N	Mean	Standard Deviation
Motivation	177	7.3314	1.6815
reward	177	6.766	1.6716
Working condition	177	7.017	1.5969
Employee satisfaction	177	6.644	1.619

Table 4 shows the independent and dependent variables, mean also standard deviation analysis. The

independent variables were motivation, reward, and working conditions, while the dependent variable was employee satisfaction in the Malaysian hotel industry. Motivation had the greatest mean score (7.3314), indicating that respondents satisfied most to this characteristic. Afterward, the lowest mean was employee satisfaction only 6.644 in this survey, indicating that respondents agreed less strongly on that dimension. The information collection with a standard deviation greater than one out of 177 respondents demonstrates the most prevalent values.

### Pearson Correlation

Pearson's correlation analysis are most fundamental procedures that looked at the linear connection between the both variables. The purpose of the study was to determine if there any correlations among the independent variables (motivation, reward, and working condition) and the dependent variable (employee satisfaction in the Malaysian hotel industry). If the link is substantial, the researchers have to identify the acceptable level of association strengths.

## Hypothesis 1

H1: There is relationship between motivation and employee satisfaction hotel industry in Malaysia.

Table 5: Correlation coefficient for motivation and employee satisfaction hotel industry in Malaysia

		Employees Satisfaction in Hotel Industry	Motivation
Employees Satisfaction in Hotel Industry	Pearson Correlation	1	0.929**
	Sig. (2-tailed)		0.000
	N	177	177
Motivation	Pearson Correlation	0.929**	1
	Sig. (2-tailed)	0.000	
	N	177	177

The Pearson correlation coefficient, significant value, and total number of responders (177) are shown in Table 5. The p-value was 0.000, less than the threshold of 0.01. Motivation component and employee satisfaction hotel industry in Malaysia exhibited a high positive link with a correlation value of 0.929.

## Hypothesis 2

H2: There is relationship between reward and employee satisfaction hotel industry in Malaysia

Table 6: Correlation coefficient for reward and employee satisfaction hotel industry in Malaysia

		Employees Satisfaction in Hotel Industry	Reward
Employees Satisfaction in Hotel Industry	Pearson Correlation	1	0.887**
	Sig. (2-tailed)		0.000

	N	177	177
Reward	Pearson Correlation	0.887**	1
	Sig. (2-tailed)	0.000	
	N	177	177

The Pearson correlation coefficient, significant value, and total number of cases (177) are shown in Table 6. The p-value was 0.000, below than the significance threshold of 0.01. The correlation value of 0.887 revealed a very high positive relationship among reward and employees satisfaction hotel industry in Malaysia.

### Hypothesis 3

H3: There is relationship between working condition and employee satisfaction hotel industry in Malaysia.

Table 7: Correlation coefficient for working condition factors and employee satisfaction hotel industry in Malaysia.

		Employees Satisfaction in Hotel Industry	Working Condition
Employees Satisfaction in Hotel Industry	Pearson Correlation	1	0.894**
	Sig. (2-tailed)		0.000
	N	177	177
Working Condition	Pearson Correlation	0.894**	1
	Sig. (2-tailed)	0.000	
	N	177	177

The Pearson correlation coefficient, significant value, and case count of 177 are shown in Table 7. The p-value was 0.000, below than the significance threshold of 0.01. With a correlation value of 0.894, there was very strong positive link among working condition and employees satisfaction hotel industry in Malaysia.

Table 8: Summary of Correlation Analysis

Hypothesis	Significant Value	Conclusion	Correlation Value	Conclusion
1	0.000	Accepted	0.929	High Positive Correlation
2	0.000	Accepted	0.887	Very High Positive Correlation
3	0.000	Accepted	0.894	Very High Positive Correlation

Correlation Analysis was employed by investigators in order to evaluate the linear relationship among the both variables identified as the research aims. Table 8 displays the outcomes of the Correlation Analysis, which demonstrated a strong positive relationship between motivation, reward and employees satisfaction in the Malaysian hotel industry. Furthermore, there is high positive correlation among working conditions and employees satisfaction in the Malaysian hotel industry.

## **DISCUSSION & RECOMMENDATION**

The research analyzing the relationship among reward factors, working condition, motivation factors, and employees satisfaction hotel industry in Malaysia. The intention of this study is to find out the relationship among motivation factors, working condition factors, reward factors, and employee satisfaction hotel industry in Malaysia.

This study shows that more research on the employee satisfaction of the hotel industry in Malaysia should be carried out, as this research is limited to workers in Malaysia, it cannot draw any conclusions. The results of this study may vary if it is extended to the satisfaction of international workers in Malaysia. As a result, rather than focusing solely on local employee satisfaction, other employees are instead expected to respond to surveys.

Further, the most recent explore only looked at 3 criteria which affect the satisfaction of hotel industry workers in Malaysia. However, this study may overlook other important aspects that affect employees satisfaction among Malaysians. As this indicates, subsequent investigators might propose additional variables, such as disclosure components, to explore their new discoveries.

The research is then narrowed down to 177 samples, which may subsequently be used to identify the target population. According to Krejcie and Morgan (1970), if the amount is sufficiently reliable, larger sample sizes should leveraged to examine millions of Malaysian tourists. Consequently, to improve the validity and reliability of their investigations, future researchers should raise their sample size. Merely having respondents complete a scale questionnaire online, conduct an interview or pose open-ended questions. Using the interview strategy, researchers may get a great deal of response and incomplete replies could be picked up on instantly. This strategy can eliminate misunderstanding and considerably improve study findings.

Finally, future researchers should be taken to stay up to date on variables that may impact the satisfaction of hotel industry workers in Malaysia as these factors can vary. It is possible to evaluate the factors affecting the trust of employees, which can help business owners in implementing more successful marketing tactics. Academics in the future may create a unique framework to analyse employee satisfaction with the hotel industry in Malaysia. As workers' happiness with the satisfaction of hotel industry workers in Malaysia fluctuates, a regional survey must be conducted to measure employee satisfaction.

## CONCLUSION

To conclude, these three factors must be addressed together to make the employee satisfaction more colorful and vivid with a diverse range of employee satisfaction, since this is one of the most effective marketing strategies. As a method to boost Malaysian tourism, employee satisfaction hotel industry in Malaysia providers and the government should work together to provide the finest service possible to employee satisfaction. The outcome of this research will aid researchers in better understanding employee satisfaction with hotel industry in Malaysia. Any subsequent research should start with a well-rounded population sample. Imbalanced sample c an inconsistency in the results, which will only favor one group. The sample size ought to be expanded to gain accurate, reliable, also uniform outcome. Researchers ought to think further dimension to identify other aspects that trigger Malaysian youth employees' enthusiasm to go to other areas. Consequently, to make the employee satisfaction hotel industry livelier by providing a variety of hotel industry services, DMOs and local governments must collaborate effectively and completely commit to providing reliable services.

## REFERENCES

- Aguinis, H., & Glavas, A. (2019). On corporate social responsibility, sensemaking, and the search for meaningfulness through work. *Journal of management*, 45(3), 1057-1086.
- Ahmad, A. H., Ibrahim, A., Ahmad, Z. H., & Masri, R. (2019). The Predictors of Sports Tourism Involvement in Malaysia: An Extreme Sport Overview. *Humanities & Social Sciences Reviews*, 7(2), 449-453.
- Akter, M., Sadekin, M. N., & Patwary, A. K. (2020). An Empirical Study on Students' Satisfaction from Mawlana Bhashani Science & Technology University, Bangladesh. *Review of Economics and Development Studies*, 6(2), 363-379.
- Al Mahmud, S. R. (2020). The effectiveness of Facebook advertisements on purchase intention of customers in Malaysia. *South Asian Journal of Social Sciences and Humanities*, 1(1), 97-104.
- Aldaihani, F. M. F., & Ali, N. A. (2018). Factors Affecting Customer Loyalty in the Restaurant Service Industry in Kuwait City, Kuwait. *Journal of International Business and Management*, 1(2), 1-14
- Ali, B. J., & Anwar, G. (2021). An empirical study of employees' motivation and its influence job satisfaction. *Ali, BJ, & Anwar, G.(2021). An Empirical Study of Employees' Motivation and its Influence Job Satisfaction. International Journal of Engineering, Business and Management*, 5(2), 21-30.
- Alom, S., Patwary, A. K., & Khan, M. M. H. (2019). Factors affecting the turnover intention of Bangladeshi migrants in the United Arab Emirates: An empirical study on the hotel industry. *International Journal of Innovation, Creativity and Change*, 8(3), 344-360.
- Barney-McNamara, B., Peltier, J., Chennamaneni, P. R., & Niedermeier, K. E. (2020). A conceptual framework for understanding the antecedents and consequences of social selling: a theoretical perspective and research agenda. *Journal of Research in Interactive Marketing*.
- Camilleri, M. A. (2018). The tourism industry: An overview. *Travel marketing, tourism economics and the airline product*, 3-27.
- Cannas, M., Sergi, B. S., Sironi, E., & Mentel, U. (2019). Job satisfaction and subjective wellbeing in Europe. *Economics and Sociology*, 12(4), 183-196. doi:10.14254/2071-789X.2019/12-4/11
- Chin, C. H., Lo, M. C., Razak, Z. B., Pasbakhsh, P., & Mohamad, A. A. (2020). Resources confirmation for tourism destinations marketing efforts using PLS-MGA: The moderating impact of semirural and rural tourism destination. *Sustainability*, 12(17), 6787.
- Csikszentmihalyi, M. (1990). *Flow: The psychology of optimal experience*. New York: Harper & Row. Reviewed by Steve Krett.
- Danish, R. Q., & Usman, A. (2010). Impact of reward and recognition on job satisfaction and motivation: An empirical study from Pakistan. *International Journal of Business and Management*, 5(2), P159.
- Deci, E. (1975). *Intrinsic Motivation*. Plenum: New York. Flynn, G. (1998). Is your recognition program understood? *Workforce*, 77(7), 30-35.



- Dolnicar S., Zare S. COVID19 and Airbnb: Disrupting the disruptor. *Annals of Tourism Research*. 2020 doi: 10.1016/j.annals.2020.102961
- Fengmin, Z., Baijun, W., Jiangtao, B., Li, L., & Patwary, A. K. (2022). Investigating revisit intention of medical tourists in China through nutritional knowledge, perceived medical quality, and trust in the physiologist: A recommendation on health tourism policy measures. *Frontiers in Public Health*, 10, 893497.
- Frempong, L. N., Agbenyo, W., & Darko, P. A. (2018). The impact of job satisfaction on employees' loyalty and commitment: a comparative study among some selected sectors in Ghana. *European Journal of Business and Management*, 10(12), 95-105.
- Gössling S., Scott D., Hall C.M. Pandemics, tourism, and global change: A rapid assessment of Covid- 19. *Journal of Sustainable Tourism*. 2020 doi: 10.1080/09669582.2020.175870
- Haque, A., Chowdhury, N. A., Yasmin, F., & Tarofder, A. K. (2019). Muslim Consumers' Purchase Behavior Towards Shariah Compliant Hotels in Malaysia. *Vidyodaya Journal of Management*, 5(1), 121-138.
- Haque, A.U., and Oino, I. (2019). Managerial challenges for software houses related to work, worker and workplace: stress reduction and sustenance of human capital, *Polish Journal of Management Studies*, 19(1), 170-189.
- Hashim, Ina Murni, et al. "Kebahagiaan bekerja melahirkan budaya kerja yang positif." *Gading Journal for Social Sciences* 24.2 (2021): 13-20.
- Hazbar, A. M. H., Alem Mohammed, A., & Karim, A. K. A. (2019). An Empirical Study of Factors Influencing hotel customers' online booking Intention. *مجلة العلوم التربوية و الدراسات الإنسانية*, (5), 1-17.
- Horaira, M. A. (2020). The economic impact of tourism on to the community of kuakata. *Asian Journal of Humanity, Art and Literature*, 7(1), 43-58.
- Horaira, M. A. (2021). Impact of COVID-19 Pandemic on Tourism Industry: Possible Reconciliation Strategy for Bangladeshi Tourism Industry. *International Tourism and Hospitality Journal*, 4(4), 1-17
- Ifinedo (2003). Employee Motivation and Job Satisfaction in Finnish Organizations: A Study of Oulu Region Employees Thesis for a Master of Business Administration at the University of London.
- Ingsih, Kusni, Wuryani, Wiwin, Suhana, Suhana. *Acedemy of Strategic Management Journal* Vol.20, iss 3,( 2021):1-11
- Kasbuntoro, D. I., Maemunah, S., Mahfud, I., Fahlevi, M., & Parashakti, R. D. (2020). Work-life balance and job satisfaction: A case study of employees on banking companies in Jakarta. *International Journal of Control and Automation*, 13(4), 439-451.
- Kyrylov, Y., Hranovska, V., Boiko, V., Kwilinski, A., & Boiko, L. (2020). International tourism development in the context of increasing globalization risks: On the example of Ukraine's integration into the global tourism industry. *Journal of Risk and Financial Management*, 13(12), 303.
- Legault, L. (2020). Intrinsic and extrinsic motivation. *Encyclopedia of personality and individual differences*, 2416-2419.

- Li, L., Ragavan, N. A., Patwary, A. K., & Baijun, W. (2022). Measuring patients' satisfaction toward health tourism in Malaysia through hospital environment, nutritional advice, and perceived value: A study on Chinese exchange students. *Frontiers in public health*, 10, 893439.
- Li, L., Wu, B., & Patwary, A. K. (2022). How marine tourism promote financial development in sustainable economy: new evidences from South Asia and implications to future tourism students. *Environmental Science and Pollution Research*, 29, 1155-1172.
- Li, L., Wu, B., & Patwary, A. K. (2022). The psychosocial factors affecting chinese Outbound Exchange and mobility students' academic performance during COVID-19. *Frontiers in psychology*, 13, 872516.
- Locke, E. A. (1976). The nature and causes of job satisfaction, In Dunnette, M. D., Editor. *Handbook of Industrial/Organizational Psychology*, McNally, Chicago, 1297-1346.
- Loeb, S., Dynarski, S., McFarland, D., Morris, P., Reardon, S., & Reber, S. (2017). Descriptive Analysis in Education: A Guide for Researchers. NCEE 2017- 4023. *National Center for Education Evaluation and Regional Assistance*
- Malay mail. (2019, August 23). Tourism contributes RM41.69b to Malaysian economy in first half 2019, new data reveals. Retrieved March 28, 2020, from Malay mail :
- Mertler, C. A., Vannatta, R. A., & LaVenja, K. N. (2021). *Advanced and multivariate statistical methods: Practical application and interpretation*. Routledge.
- Milkovich, G. T., & Boudreau, J. W. (1997). *Human Resource Management*. Irwin McGraw-Hill.
- Mishra, P., Pandey, C. M., Singh, U., Gupta, A., Sahu, C., & Keshri, A. (2019). Descriptive statistics and normality tests for statistical data. *Annals of cardiac anaesthesia*, 22(1), 67.
- Nadef, Z. A. (2018). Comparative study on job satisfaction of J & K bank employees. *North Asian International Research Journal of Social Science & Humanities*, 4(1), 281-293.
- Nasir, M.N.M., & Wongchestha, N. (2022). Parallel Mediators of Place Attachment and Tourist Motivation in Involvement and Destination Loyalty: A Conceptual Model. *International Journal of Hospitality & Tourism Systems*, 15(2), 103-105.
- Newsham, G., JayBrand, C. D., Veitch, J., Aries, M., & Charles, K. (2009). Linking Indoor Environment Conditions to Job Satisfaction. *Building Research & Information*, 37(2), 129- 147.
- Ong, M. H. A., & Puteh, F. (2017). Quantitative data analysis: Choosing between SPSS, PLS, and AMOS in social science research. *International Interdisciplinary Journal of Scientific Research*, 3(1), 14-25
- Paais, M., & Pattiruhu, J. R. (2020). Effect of motivation, leadership, and organizational culture on satisfaction and employee performance. *The Journal of Asian Finance, Economics, and Business*, 7(8), 577-588.
- Patwary, A. K., Roy, B., Hoque, R., & Khandakar, M. S. A. (2019). Process of developing a community based tourism and identifying its economic and social impacts: An Empirical study on Cox's Bazar, Bangladesh. *Pakistan Journal of Humanities and Social Sciences*, 7(1), 1-13.
- Rahmanov, F., Aliyeva, R., Rosokhata, A. S., & Letunovska, N. Y.(2020). Tourism management in Azerbaijan under sustainable development: impact of COVID-19.

- Shamsudin, M. F., Esa, S. A., & Ali, A. M. (2019). Determinants of customer loyalty towards the hotel industry in Malaysia. *International Journal of Innovation, Creativity and Change*, 6(9), 21-29
- Sroka, W., Pysz, J. K., Wróblewski, Ł., and Majerova, J. (2019). *New Trends in Management: Regional and Cross-border Perspectives*, UK: London Scientific
- Sumethokula, P., Patwary, A. K., Srinuanpanc, B., Srinuanpand, C., Suwandee, P., Thammathikul, A., & Phanong, W. (2020). The potential of new tour repackaging for creative tourism among entrepreneurs in Nakhon Si Thammarat. *International Journal of Innovation, Creativity and Change*, 13(10), 1752-1771.
- Syamsir, S. (2020). Competence, Job Satisfaction, Work Motivation, and Job Performance of The Village (“Nagari”) Masters in Managing E- Village Finance. *International Journal of Advanced Science and Technology*, 29(8), 1337- 1350
- Wakimin, N.; Azlina, A.; Hazman, S. Tourism demand in Asean-5 countries: Evidence from panel data analysis. *Manag. Sci. Lett.* **2018**, 8, 677– 690.
- Wu, B., Liu, S., Wang, J., Tahir, S., & Patwary, A. K. (2021). Assessing the mechanism of energy efficiency and energy poverty alleviation based on environmental regulation policy measures. *Environmental Science and Pollution Research*, 28, 40858-40870.
- Wu, B., Zhai, B., Mu, H., Peng, X., Wang, C., & Patwary, A. K. (2021). Evaluating an economic application of renewable generated hydrogen: A way forward for green economic performance and policy measures. *Environmental Science and Pollution Research*, 1-15.

# The Factors that Influence Tourism Demand in Malaysia

**Mohd Nazmi Syah Bin Malik Faisal, Mohd Zaquan Fikri Bin Mohd Zaki, Muhamad Fathuddin Bin Muhamad & Mugilan A/L Ganas, Marlisa Abdul Rahim**

*Faculty of Hospitality, Tourism and Wellness, Universiti Malaysia Kelantan*

marlisa@umk.edu.my

## **ABSTRACT**

The objective of this study is to analyse the correlation between the variables under consideration of quality of accommodation, uniqueness and service quality among tourist demand in Malaysia. It is discovered quality of accommodation, uniqueness and service quality were the major needs in tourism industry that effect tourist demand in Malaysia. The international tourist and local tourist subject matter at hand pertains to the act of being specifically singled out for a particular purpose or objective respondents and a total of 208 respondents were successfully responded through the online survey. The data that was gathered underwent analysis through the utilisation of the Statistical Package for Social Science (SPSS) version 26.0. Ladies and gentlemen, today we shall be discussing the SPSS Statistical software. This software is designed to cater to the entire statistical analysis process, from planning to data collection, analysis, and reporting. Its primary objective is to enhance decision-making and performance. In this study, the Pearson correlation coefficient was utilised to examine the correlation between the variables quality of accommodation, uniqueness and service quality towards tourist demand. The result shows a significance effect of quality of accommodation, uniqueness and service quality towards tourist demand. Through this study can understand, a tourism sector's reputation could be improved by improving its accommodations, uniqueness, and service quality. This would only lure more tourists to the same site.

**Keywords:** Tourism sector, tourist demand, accommodations, uniqueness, and service quality.

## **INTRODUCTION**

Ladies and gentlemen, it is imperative to acknowledge that tourism plays a pivotal role in the economic growth and development of numerous nations across the globe. Ladies and gentlemen, it is my pleasure to discuss with you today the various benefits that tourism can bring to host cities. As per Yehia's research in 2019, tourism has been found to have a positive impact on a country's economy by increasing its revenue and creating numerous job opportunities. Additionally, it has been observed to enhance a nation's infrastructure and promote cultural exchange between its citizens and visitors from other countries. In recent decades, both international tourism and the importance of tourism to many nations' economies have grown. It is noteworthy that tourism has been incorporated into three of the seventeen universal goals. These goals include goal 8, which pertains to the attainment of decent employment and economic development, goal 12, which emphasises responsible consumption, and goal 14, which focuses on life below water. Good afternoon, class. Today, we will be discussing the work of Comerio and Strozzi in their 2018 publication. Tourism are often seen as the sector of the economy that will thrive in the years to come. It has been suggested by Chalupa that the worldwide phenomena of the present are an important carrier of globalization processes. The topic we are discussing here is the current global phenomenon (Pellešová, 2019).

Tourism promotes growth. It contributes 10% of global GDP and employment. Every other economic sector is tied to the industry. Its capacity to operate in several regions and provide entry level employment and beyond helps overcome development and income divides (Peng, 2019). The tourism industry has grown to become a significant global and national economic force. The industry has expanded rapidly and is now a force in promoting long-term, positive social and economic change across the world. Yet, tourism is a major contributor to environmental deterioration due to its impact on carbon dioxide emissions (GHG) (Wakimina et al., 2018). There are always plenty of difficulties for any given government in attempting to increase tourism. However, although numerous publications have verified that industry may aid in boosting tourism, very few studies have explored the function of both agricultural and manufacturing sectors in doing so, as was witnessed over the 2 previous decades. Second, there is a paucity of research linking political stability to tourist demand in the ASEAN area, even though this is the element with the greatest influence (Nguyen & Nguyen, 2020).

Malaysia's economy has seen tremendous development in the previous 10 years, notably in the domains of e-commerce and digital banking. E-commerce, in particular, has grown in importance. Digital technology has a significant impact on the running of economies due to its capacity to grow the size of firms, boost economic efficiency, improve user experiences, lower operational costs, and better manage financial risks (Mentek, 2022). Digital technology was critical in restoring economic stability during the Covid-19 pandemic. Accurately locating confirmed cases of the disease, moving many financial dealings online, and enabling local governments to provide vouchers for consumer purchases all contributed to this success. As a consequence of 5G and other technology advancements, as well as infrastructural upgrades, Malaysia's digital economy is expected to grow at a faster pace in the next few years, ushering in a higher number of major changes. To ensure that the program runs well, the authorities will need to handle some additional issues (Yipping. Et al., 2021).

This research highlights three criteria that influence tourist demand: quality of accommodation, uniqueness and service quality. Each variable has its explanation for how it might affect tourist demand. There are links between the tourist's selection and the tourist's desire to experience the product again. All of the elements in tourism have an essential part in influencing the number of tourists that visit the tourist site. If a tourist is happy with their experience in Malaysia, they would most likely return or suggest Malaysia to their friends and family members. Tourist satisfaction with Malaysia is critical since it will contribute to the growth of Malaysia's tourism business. Malaysia should understand what is on tourists' minds about Malaysia to meet their expectations and ensure that their perception matches what they will encounter. Thus, the purpose of this research is to look at the aspects that impact tourist demand in Malaysia, such as quality of accommodation, uniqueness and service quality. All of these characteristics will be examined to determine their link to tourist demand. The target of the study is the tourism demand in Malaysia. The focus of this research will be on the topic at hand quality of accommodation, uniqueness and service quality

The study was undertaken with the subsequent aims and objectives:

- a. To examine the relationship between the quality of accommodation and tourism demand in Malaysia.
- b. To investigate the relationship between uniqueness and tourism demand in Malaysia.
- c. To analyze the relationship between service quality and tourism demand in Malaysia.

## **SIGNIFICANT OF THE STUDY**

The research study could offer details on how the quality of accommodations, uniqueness, and service quality can affect tourist demand to return to Malaysia.

In addition, this study will examine how to enhance Malaysia's image in order to attract more tourists, especially in the future. Due to the study's improvement of locals and tourists' knowledge of potential problems with the quality of accommodations, it will be beneficial to the country's tourism industry and cultural heritage.

Additionally, as this study will give the required details on the elements that influence a nation's uniqueness, it may be advantageous to both tourists and residents. This could alter tourists' perceptions of Malaysia and cause them to change their minds. This study can give future researchers a baseline understanding of the current state of tourist demand in Malaysia.

### **Researchers**

The outcome of the investigation shall facilitate the assessment of the correlation among three variables by the researchers: quality of accommodation, uniqueness and service quality and tourist demand in Malaysia. The result will help researchers aspire to understand much about the factors that influence tourism demand in Malaysia.

### **Owners**

This study will provide information about the individual's satisfaction with services. This study will evaluate a quality of accommodation, uniqueness and service quality to know the type of behavior that can be involved when using services. Get to know the behavior of customers and the decision making when an individual or group uses the services. Data gathered will help owners know what factor influent them when purchased a service.

### **Tourism demand**

Today, we will be discussing the concept of tourism demand. As we delve into the topic of tourism, it is important to understand the concept of tourism demand. In essence, tourism demand refers to the desire and inclination of individuals to consume various travel-related products and services within a particular market or location, at a given time and for a specific cost. In essence, tourism demand refers to the desire for goods and services that are related to the tourism industry. As we delve into the realm of tourism, it becomes apparent that catering to the needs and wants of visitors and consumers alike is an integral aspect of the tourism demand. It is imperative to comprehend the intricacies of supply and demand within the purview of the business being scrutinised. As we delve into the intricacies of the tourism product, we come to realise that it is not a singular entity but rather a multifaceted amalgamation of numerous intangible services. This poses

an even greater challenge in the context of tourism. As we can see here, the authors Song et al. in 2019, Song and Li in 2008, and Wu et al. in 2017 have all contributed to this topic.

## **LITERATURE REVIEW**

### **Antecedents of tourism demand**

There are many variables or factors that contribute to tourist demand in the tourism sector. The first case study that have been chosen and examined was "The Impact of Accessibility Quality and Accommodation Quality on Tourists' Satisfaction and Revisit Intention to Rural Tourism Destination in Sarawak: The Moderating Role of Local Communities' Attitude "by Chee Hua Chin, Fung-Yee Law, May-Chiun Lo, T.Ramayah. The measured variables in this case study are the activity appeal, a consideration of the influence of the accessibility and accommodation quality.

### **Quality of accommodation**

The idea of accommodation was initially used by renowned psychologist J.M. Baldwin 2010. He claims that the phrase refers to learned adjustments in people's behaviour that aid in environment adaptation. "The word accommodation has been used to designate the changes people in groups make to relieve the weariness and stress of rivalry and conflict,(Lundberg 2009). Sociologists use the term "accommodation" to refer to how hostile people or groups adjust (Nimkoff & Ogburn 2009). Conflict naturally leads to accommodation: Conflicts allow for accommodation because they cannot always persist. When parties or individuals engaged in a dispute do not enjoy the conflict's current state, they sit down to try to resolve it. These settlements, whether transient or permanent, may be referred to as 12 "accommodation." Conflicts do not exist when the issue of finding accommodations does not exist. Both the "condition" and the "process" of accommodation are universal. Conflicts are necessary since antagonistic elements make up human civilization. Accommodation becomes necessary since no community can exist in a condition of constant strife. As a result, accommodations can be found throughout all societies and sectors of social life. The process of accommodation is not limited to any one stage of a person's life. It is not constrained by any specific social circumstance either. On the other hand, one must learn to adjust to different conditions throughout life. Additionally, if and when conflicts arise, accommodation would follow sooner or later. The groupings that make up society must make accommodations for one another as well as for the individuals who belong to them. As a first step toward assimilation, it might act to lessen tension between individuals or groups. As in a treaty between nations or labour management pact, it may serve to temporarily put off outright conflict. It might make it possible for groups with pronounced sociopsychological gaps to get along.

### **Uniqueness**

A person or object is said to be unique when it differs from everything else in comparison, or when it is noteworthy or exceptional. When used in reference to people, it frequently refers to a person's personality or certain aspects of it, indicating that they differ from the personality traits that are typical in their culture (Tayob,Abdulkador,2004).When the word "uniqueness" is used to

describe something, it's frequently in the context of a product (Strack, Stephen, 2006). The term is then used to promote or sell the product in an effort to set it apart from similar items in the same category (Baumol, William, 2008). The idea of American exceptionalism is based on the West's distinctiveness, especially its clearly defined secularism (Headley & John 2012).

### **Service quality**

This notion of service excellence is founded on the expectancy-disconfirmation paradigm, which serves as the foundation for the framework. (Balakrishnan & Barry, 2007). A company that offers good service quality will continue to be economically competitive while meeting or exceeding customer expectations (Kenzelman 2008). As per empirical studies conducted by Parasuraman in 2008, it has been observed that there exists a correlation between enhanced service quality and increased profitability as well as long-term economic competitiveness. It is imperative to measure customer satisfaction and other performance outcomes in order to enhance operational procedures. By doing so, problems can be identified promptly and systematically, and service performance measurements can be established that are both valid and trustworthy. Ultimately, this leads to improved operational processes. (Oliver Joseph Brady, 2000). As a result of the intangible character of services and the fact that they are sometimes subjectively experienced, experts have historically regarded service quality as being particularly challenging to define and quantify (Barry 1985). The so-called Nordic School made one of the early attempts to address the idea of service quality. According to this method, there are only two fundamental dimensions for service quality (Oliver 2011).

## **Relationship between the quality of accommodation, uniqueness, service quality and tourism demand in Malaysia**

### **Relationship between the quality of accommodation and tourism demand in Malaysia.**

According to Chin et al., (2018), persons who evaluated a favorable level of accommodation quality would have more intent and be more satisfied with their conduct. It is now well-accepted that high-quality lodging is a crucial factor in boosting vacationers' happiness Shonk (2018).

Now, in the realm of tourism, the term "accommodation" encompasses a variety of premises, including but not limited to hotels and motels within urban areas. Conversely, in the context of rural tourism, accommodation may take the form of village stays or homestays. Among the most common options for visitors to rural tourist hotspots is a homestay Chin et al.(2018). According to the findings of previous research, the physical aspects do play a role in determining the quality of the accommodations in rural areas. In particular, the state of the facility, the furnishings, and the cuisine all play a role in determining the quality of the accommodations (Deshmukh) 2018. They will be more likely to visit Malaysia in the future if they have a positive experience with the service and quality of their accommodations, which can both meet the requirements of foreign visitors and keep them coming back.

When tourists from other countries go to Malaysia, the quality of their accommodations and the level of service they get are two of the most significant factors for them to consider. Therefore, the level of service provided by accommodation is taken into consideration to be a significant component that influences the level of satisfaction experienced by tourists. As tourists want to



guarantee that the quality of accommodation meets their expectations before traveling, it is critical that the host country's accommodation meets tourism demands (Deng et al, 2019).

### **Relationship between the uniqueness and tourism demand in Malaysia.**

According to Karagoz et al. (2020), the individual's reliance on uniqueness is typically a psychological structure that examines the individual's reliance on uniqueness due to a personality attribute. When a person exhibits the need to seek items or services that exhibit distinction and achievement, uniqueness is required. The advertising firm will be asked to provide a variety of stunning, soothing, and aesthetically pleasing photographs. People nowadays often have preconceived notions of what they will see at a tourist attraction or trip (Hikmah et al., 2018).

Furthermore, Thai tourists who have a positive experience in Malaysia or who are drawn to the country by its distinctive tourism offerings will tell their friends and family back home about their travels. As a result, boosting the marketing of Malaysia's tourism is simultaneous with spreading knowledge about Malaysia's tourism to attract prospective Thai tourists. Promotion of Malaysian tourism at the right moment and with the right amount of information will attract Thai tourists and allay their fears about the country's security (Thien et al., 2018).

Malaysia cares about its multicultural community. Before Merdeka, numerous races lived in Malaysia. Malaysians are Malay, Chinese, and Indian, but there are also Iban, Dayak, and Kadazan. Everyone lives peacefully. Malaysians accept each other's culture and religion as evidence. Hari Raya, Chinese New Year, and Deepavali are also celebrated. Malaysia is distinct and powerful because all races stand together (Sutra, 2019).

### **Relationship between service quality and tourism demand in Malaysia.**

When used in the field of tourism research, the term "destination service quality" refers to the degree of service performance achieved at each characteristic (Chen & Chen, 2019). In this age of increased competition in destination management, service quality has become critical. Tourist sites are more likely to attract both first-time and repeat tourists if they provide high-quality services. Tourists who had a positive experience are more inclined to tell their friends and family about it. This generates both recurring business and the possibility of new business Vassiliadis et al. (2018).

One of the most significant benefits that can be acquired via the efficient delivery of highquality tourist services and unforgettable experiences at a tourism destination is loyalty to the area. This may be accomplished in a number of ways Akroush et al. (2018). According to (Khan et al.,2013), vacation spots that provide higher-quality services are more likely to entice visitors and fulfill their expectations once they get there. In addition, a number of studies (Silvestri et al., 2017) amongst others, have revealed that the quality of the service provided is an important factor in determining the level of satisfaction experienced by tourists.

## Research Hypothesis

A hypothesis must be testable and realistic, taking current knowledge and methodologies into account. Furthermore, a hypothesis is a forecast or explanation of a link between two variables. It suggests that an independent variable and a dependent variable have a systematic connection. As a result, the research suggests:

Taking into account the aforementioned factors, the following research hypotheses are developed:

H1: Quality of accommodation has a positive relationship with tourist demand.

H2: Uniqueness has a positive relationship with tourist demand.

H3: Service quality has a positive relationship with tourist demand.

## Conceptual Framework

The suggested structural equation model of tourist demand intention is shown in Figure 1. The model reveals a direct causal-effect relationship between the variables that affect tourism demand in Malaysia. Previous research, including that done by Nagi Medai, Naoyuki Okamoto, Yu Ogasawara, and Katsuya Hihara (2022), supports this association. (In this study, three variables will be analyzed. Based on prior studies, quality of accommodation, uniqueness and service quality will expect to have relationships with tourism demand. The relationship of the variables shows in Figure 1.

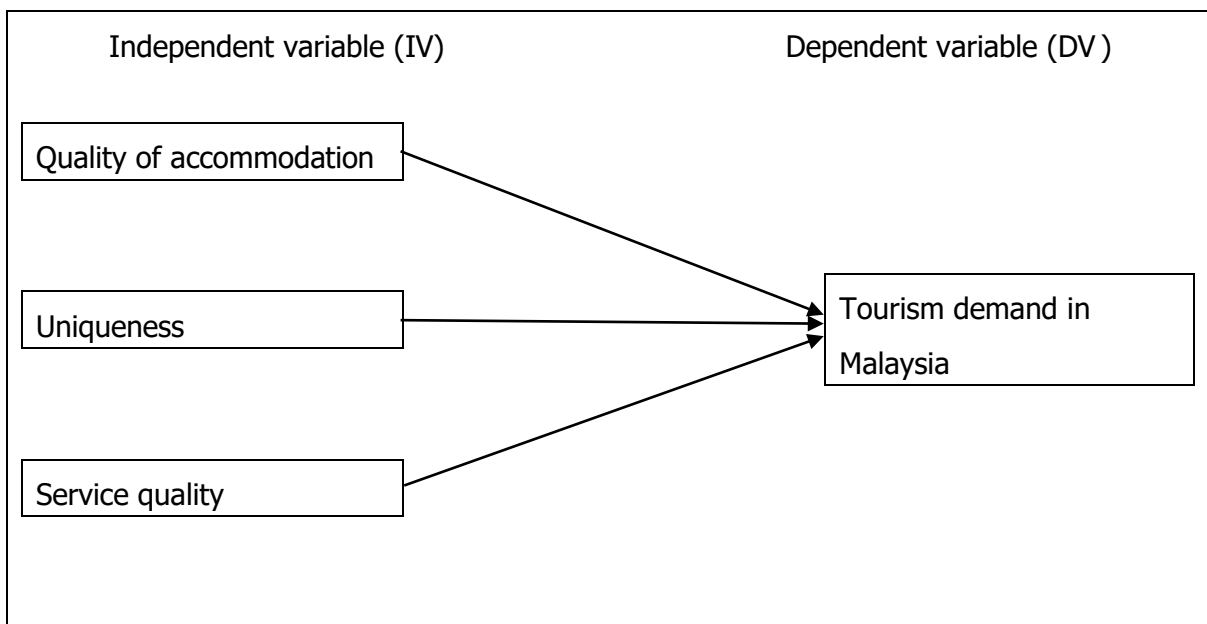

Figure 1 : Conceptual Framework of Quality of Accommodation, Uniqueness and Service Quality towards the Tourist Demand

## METHODOLOGY

### Research Design

Research design is also important in determining a method to conduct research (Nusaibah, 2019). According to Willey, (2020) research is also an action plan in the collection, measurement and analysis of data that is implemented empirically in a research. The design of the study will be adapted as a maximum control over the factors that are problematic about the findings of the study. (Burns & Grove, 2002). Boris F.Blumberg's statement, (2011) stated that the plan in forming the answer to make the research design. Research design can also be categorized as research purpose, exploratory testing, descriptive or hypothesis (sekaran & bougie, 2010). According to Maxwell, (2005) states that the study design will also affect the research questions and research objectives. The research design also has a good measurement method in determining the research objectives, research questions and hypotheses.

### Target population

As we delve into the realm of research, it is imperative that we establish a clear understanding of the term "population". In essence, population refers to the entirety of individuals, occurrences, or entities that are of relevance to the researcher's inquiry and warrant investigation (Sekaran and Bougie 2009). Population refers to the total number of people from whom samples will be drawn. The population is also the entire subject of the study while the sample is a part of the population. This study will focus on international tourists in Malaysia where the target population is 131.7 million (Domestic Tourism, 2020).

### Sample Size

According to Boris F.Blumberg et al., (2011) stated that sample size is the total population that has been summarized into a small sample. The number of respondents selected to be a small population according to regulations (Sekaran and Bougie, 2009). The sample of this study consists of requests from overseas tourists who come to Malaysia. The minimum sample size of this study is 384 foreign tourists from various countries. Therefore, the total number of respondents of 384 tourists will be selected based on Krejcie & Morgan's table (Krejcie & Morgan 1970) as shown below.

S = sample size

$X^2$  = the table value of chi-square for 1 degree of freedom at the desired confidence level (3.841)

N = the population size of domestic tourist in a year

P = the population proportion (assumed to be 0.5 since this would provide the maximum sample size) d = the degree of accuracy expressed as a proportion (0.5)

$$S = \frac{x^2 NP(1 - P)}{d^2(N - 1) + (x^2 P(1 - P))}$$

$$S = 3.841(2054000000)(0.5)(1 - 0.5) / (0.05)^2(2054000000 - 1) + 3.841(0.5)((1 - 0.5))$$

$$S = 1972353500 / 5135000.958$$

$$S = 384.099$$

$$S = 384$$

It is important to note that the sample size for the population is precisely 384. However, it is worth mentioning that the data collected from respondents through the questionnaire return was based on a sample size of 204.

## **Data Collection**

A collection of information called data may include words, numbers, measurements, observations, or merely descriptions of various objects. The information obtained from the data can be used to achieve various goals whether it's individual, group, company and so on.

Primary data is information regarding the factors affecting the study topic that has been gathered by researchers themselves or under their direction and supervision. Original, genuine, trustworthy, objective, legitimate, and most crucially unpublished, this data should be acquired by researchers themselves or under their supervision and assistance. (Ganesha & Aithal, 2022)

In this study, our group decided to use primary data as a source of data collection. The primary data we will use is through questionnaires and the questionnaire will be distributed online survey or in any other way to reach the respondents to get primary data.

A questionnaire is a tool consisting of a series of questions or items designed to collect data from respondents regarding their attitudes, experiences, or opinions. Questionnaires are a viable tool for gathering either quantitative or qualitative data. This study has decided to use close ended questions.

The purpose of this analysis will be displayed on the front page of the form that will be distributed to respondents. This is because it aims to tell the respondents the purpose of why this study was conducted so that they can provide more accurate information based on the correct perspective.

## **Sampling**

Data collection should have a systematic process in providing good data based on questionnaires provided by the researcher. Data collection also has good knowledge from various aspects (Sekaran & Bougie, 2009). According to Kumar (2011) data collection can also go through the process of testing hypotheses according to certain phenomena. This study has evaluated three hypotheses based on the dependent and independent variables outlined in the preceding chapter.

Data collection methods need to have original sources in testing hypotheses. A good researcher will also develop a strong reputation to ensure that research methods can be organized according to logic and basis (Olsen, 2011). According to Al Mansor, (2012) he stated that the data collection method has been divided into two approaches namely quantitative approach and

qualitative approach. Quantitative approach is research that addresses the objective of the study through empirical assessors involving measurement and numerical analysis (Boris F.Blumberg et al., 2011). According to (Merrigan & Huston, 2004) the qualitative approach is an approach that does not involve the form of numbers or statistics. Usually, this data collection involves interviews or conversations. The questionnaire also has closed questions for non-involved respondents. This approach can also be measured by mathematical methods (Robert B.burn, 2008). For example, correlation, regression, chisquare, mode, median and mean approaches.

Quantitative analysis and non-probability sampling techniques will be used in this investigation. Instead of testing a hypothesis based on a small number of large populations, these analyses seek to better understand a community (McCombes, 2021). In this analysis, the nonprobability sampling methodology was selected as the best sample strategy. Convenience sampling will be used in this investigation.

Convenience sampling will aid in data collection for researchers. It is the most widely used sampling procedure since it is so quick, easy, and economical (Fleetwood, 2020). This methodology was chosen for this inquiry due to the benefits and practicality of using various sampling approaches in situations when there are large populations.

### Research Instrument

A Research Instrument is a tool used to collect, measure, and analyse data related to your research interests. The Research Instrument is usually determined by researchers and is tied to the study methodology.

Table 1: Measurement items

Measurements	Number of items in the questionnaires	Scales used	Author
Section A: Demographic information	4	1-10	
(Dependent Variables) Section B: Factors influences tourism demand	5	1-10	Seyidov and Adomaitienė (2016)
(Independent Variables) Section C: quality of accommodation	5	1-10	Kamata and Misui (2015)
(Independent Variables) Section D: Uniqueness	5	1-10	Jafari (2000)
(Independent Variables) Section F: Service Quality	5	1-10	(Seo, Moon, & Lee, 2015)

Total	24		
-------	----	--	--

## DATA ANALYSIS

Researcher will use the use the programmed Statistical Programmers for Social Science (SPSS) version 27 to examine the primary data. SPSS is a program-based data processing and analysis window that allows you to create tables and pie charts. Computers aided researchers in lowering the effort required to determine information and making quantitative analysis easily and quickly. The researcher uses descriptive statistics, reliability statistics, Pearson's correlation, and regression to evaluate quantitative data.

## FINDINGS

### • Demographic Profile of Respondent

Table 2: Demographic Profile of Sample

CHARACTERISTIC		FREQUENCY	PERCENTAGE (%)
Gender	Male	105	50.5%
	Female	103	49.5%
Age	20 years old and below	19	9.1%
	21 - 30 years old	109	52.4%
	31 - 40 years old	40	19.2%
	41 - 50 years old	33	15.9%
	50 years old and above	7	3.4%
Race	Malay	151	72.6%
	Chinese	15	7.2%
	Indian	42	20.2%
Religion	Islam	152	73.1%
	Buddha	14	6.7%

Hindu	38	18.3%
Christian	4	1.9%

The respondent profile is summarized in Table 2. The total number of respondents for male was 105 respondents while the total of female is 103 respondents. The highest percentage of respondents was respondents in range of age 21-30 years old (52.4%), the second highest is age range 31-40 years old (19.2%). The third one is age range 41-50 years old (19.2%) and the fourth one is age range 20 years old and below and the least total respondents is age range of 50 years old and above.

Besides, there were 208 respondents which consist of Malay with 151 respondents (72.6%), followed by Indian with 42 respondents (20.2%) and lastly Chinese with 15 respondents (7.2%). Meanwhile the highest total number of respondents based on religion is Islam with 152 respondents (73.1%). The second one is Hindu with the total of 38 respondents (18.3%).

### RELIABILITY TEST

A reliability test is a method used to evaluate the stability and performance of a system over a specific period and under different testing conditions. It is a crucial tool for assessing the overall reliability of a system. Prior to its distribution through an online survey, a pilot test was administered to a cohort of 30 individuals. The subsequent sample size for the survey was 208 participants.

Table 3: Results of Reliability Test

Variable	Number of Items	Cronbach's Alpha Coefficient	Strength of Association
Quality of Accommodation	5	0.960	Excellent
Service Quality	5	0.963	Excellent
Uniqueness of Destination	5	0.958	Excellent

Tourism Demand	5	0.919	Excellent
----------------	---	-------	-----------

Cronbach’s Alpha Coefficient values for the independent and dependent variables in this study are shown in Table 3. Based on the table above, it can be concluded that all the variables were more than 0.9. Consequently, the presented variable is reliable and may be accepted in this study. For dependent variable which is Tourism Demand was measured using five questions, and the Cronbach’s Alpha result for this question section was 0.919 which was excellent. As a result, the coefficients derived for the Tourism demand variable were reliable.

Besides that, for independent variable which is Quality of Accommodation, there were five questions in assessing the quality of accommodation variable that affected tourism demand in Malaysia and the result was 0.960 which was excellent. As a result, the coefficients produced for the reliability variable questions were reliable.

Furthermore, there were five questions utilized to measure the service quality that affected tourism demand in Malaysia and the outcome of the result is 0.963 which was excellent. As a result, the coefficients for the safety variables were reliable.

Last but not least, there were five questions utilizes to measure the uniqueness of destination that affected tourism demand in Malaysia and the outcome of the result is 0.958 which was excellent. As a result, the coefficients for the safety variables were reliable.

## DESCRIPTIVE ANALYSIS

The present study has conducted an analysis of the mean and standard deviation values pertaining to sections B, C, D, and E of the questionnaire.

Table 4: Descriptive Statistics

<b>Variables</b>	<b>N</b>	<b>Mean</b>	<b>Standard Deviation</b>
Quality of Accommodation	208	8.86	0.961
Service Quality	208	9.024	0.958
Uniqueness of Destination	208	8.826	0.963
Tourism Demand	208	8.95	0.958



Table 4 shows the dependent variable and independent variable, the mean and standard deviation analysis. The independent variable is Quality of Accommodation, Service Quality and Uniqueness of Destination while the dependent variable is Tourism Demand in Malaysia. The highest mean value was Service Quality which is 9.024 where respondent agreed more on this factor. Meanwhile, the lowest mean is Uniqueness of Destination, which shows that the respondents agreed lower for that variable. The data set with the standard deviation of more than 0.9 out of 208 respondents who's more dispensing values.

## PEARSON CORRELATION

One of the most important analyses that examined the linear relationship between the two variables was Pearson's correlation analysis. The goal of this study was to see if there were any relationship between the independent variables (quality of accommodation, service quality and uniqueness of destination) and the dependent variable (tourism demand in Malaysia). If the relationship is substantial, the researcher must determine what degree association strength is acceptable

### Hypothesis 1

H1: There is relationship between Quality of Accommodation and Tourism Demand in Malaysia

Table 5: Correlation coefficient for Quality of Accommodation and Tourism Demand in Malaysia

		Tourism Demand	Quality of Accommodation
Tourism Demand		.820	1
	Pearson Correlation		
	Sig. (2-tailed)	.000	
	N	208	208
Quality of Accommodation		1	.820
	Pearson Correlation		
	Sig. (2-tailed)		.000

Table 5 shows the Pearson correlation coefficient, the significant value, and the total number of respondent (208). The p-value was 0.000, which was less than 0.01 level of significance. The Quality of Accommodation component and Tourism Demand exhibited a high positive link with a correlation value of 0.820.

## Hypothesis 2

H2: There is relationship between Service Quality and Tourism Demand in Malaysia

Table 5: Correlation coefficient for Service Quality and Tourism Demand in Malaysia

	Tourism Demand	Service Quality
Tourism Demand	1	.794
Pearson Correlation		
Sig. (2-tailed)		.000
N	208	208
Service Quality	.794	1
Pearson Correlation		
Sig. (2-tailed)	.000	
N	208	208

Table 5 shows the Pearson correlation coefficient, the significant value, and the total number of respondent (208). The p-value was 0.000, which was less than 0.01 level of significance. The Service Quality component and Tourism Demand exhibited a high positive link with a correlation value of 0.794.

### Hypothesis 3

H3: There is relationship between Uniqueness of Destination and Tourism Demand in Malaysia

Table 5: Correlation coefficient for Uniqueness of Destination and Tourism Demand in Malaysia

	Tourism Demand	Uniqueness of Destination
Tourism Demand	1	.781
	Pearson Correlation	
	Sig. (2-tailed)	.000
	N	208
Uniqueness of Destination	.781	1
	Pearson Correlation	
	Sig. (2-tailed)	.000
	N	208

Table 5 shows the Pearson correlation coefficient, the significant value, and the total number of respondent (208). The p-value was 0.000, which was less than 0.01 level of significance. The Uniqueness of Destination component and Tourism Demand exhibited a high positive link with a correlation value of 0.781

### DISCUSSION AND RECCOMENDATION

The study analyzing the relationship between Quality of Accommodation factors, Service Quality factors and Uniqueness of Destination factor and Tourism Demand in Malaysia. The purpose of this study is to determine the relationship between Quality of Accommodation factors, Service Quality factors and Uniqueness of Destination factor and Tourism Demand in Malaysia

This study suggest that more research need to be conducted on tourists especially foreigner that has traveled in Malaysia. This because this research was limited to Malaysian visitors, which cause to unable to draw further conclusions. The result of this study may differ if its open to international visitors in Malaysia and it will surely could fill out the answers of important questions in surveys.

In addition, the current study is focusing limited to only three characteristics that influence Tourism Demand in Malaysia and potentially ignoring another crucial factor. Future researcher should

consider including additional variables such as economic factored to generate new findings in their research.

Furthermore, the current study also only limited to 384 respondents according the ratio of Krejcie and Morgan (1970) table. Higher sample sizes might be useful to applied to analyzed millions of local tourists to improve the validity and reliability of research data.

Finally, Future researcher could consider using interview methods or open-ended questions. This is because it may provide more specific answer to collect data than online scaling questionnaire. Interviews can yield a high respond rate and enable to clarify any ambiguities. This method could produce more accurate results.

## **CONCLUSION**

In conclusion, these three factors must be addressed together to attract and increase the tourism demand in Malaysia, with more quality services, facilities and marketing strategies. One of method that could boost Tourism Demand in Malaysia is the government should focus more on providing quality services to local tourist, modify or create tourist attraction while following Sustainable Development Goal (SGD) because tourist love uniqueness and something different to experience. The result of this study will aid researcher in better understanding tourism demand in Malaysia. Future research should also consider doing research on well balance population and note solely focus only one group. Last but not least, larger sample size also helps to acquire more precise and accurate findings on this research. Researcher also should consider more variables that may affect more tourism demand in Malaysia.

## REFERENCES

- Ahmad Sahir Jais, Azizan Marzuki, 2020. E-hailing services in Malaysia: current practices and future outlook, 18(3), 128-141
- Akter, M., Sadekin, M. N., & Patwary, A. K. (2020). An Empirical Study on Students' Satisfaction from Mawlana Bhashani Science & Technology University, Bangladesh. *Review of Economics and Development Studies*, 6(2), 363-379.
- Alom, S., Patwary, A. K., & Khan, M. M. H. (2019). Factors affecting the turnover intention of Bangladeshi migrants in the United Arab Emirates: An empirical study on the hotel industry. *International Journal of Innovation, Creativity and Change*, 8(3), 344-360.
- Chung, J. F., & Al-Khaled, A. A. S. (2020). The Ride-Hailing Services: An Empirical Study among Private University Students in Klang Valley, Malaysia. *International Journal of Academic Research in Business and Social Sciences*, 10(12), 769-785. [https://www.researchgate.net/publication/348176529\\_The\\_RideHailing\\_Services\\_An\\_Empirical\\_Study\\_among\\_Private\\_University\\_Students\\_in\\_Klang\\_Valley\\_Malaysia\\_content/uploads/papers/v7i5s/ES2132017519.pdf](https://www.researchgate.net/publication/348176529_The_RideHailing_Services_An_Empirical_Study_among_Private_University_Students_in_Klang_Valley_Malaysia_content/uploads/papers/v7i5s/ES2132017519.pdf)
- Determinants of E-hailing Service Adoption in Restoring Pre-Pandemic Normalcy, 11(6), 874-882 [https://hrmars.com/papers\\_submitted/10218/understanding-the-determinants-of-e-hailing-service-adoption-in-restoring-pre-pandemic-normalcy.pdf](https://hrmars.com/papers_submitted/10218/understanding-the-determinants-of-e-hailing-service-adoption-in-restoring-pre-pandemic-normalcy.pdf)
- Fengmin, Z., Baijun, W., Jiangtao, B., Li, L., & Patwary, A. K. (2022). Investigating revisit intention of medical tourists in China through nutritional knowledge, perceived medical quality, and trust in the physiologist: A recommendation on health tourism policy measures. *Frontiers in Public Health*, 10, 893497.
- Hazbar, A. M. H., Alem Mohammed, A., & Karim, A. K. A. (2019). An Empirical Study of Factors Influencing hotel customers' online booking Intention. *مجلة العلوم التربوية و الدراسات الإنسانية*, 5(5), 1-17. [https://www.researchgate.net/publication/343087867\\_ehailing\\_services\\_in\\_malaysia\\_current\\_practices\\_and\\_future\\_outlook](https://www.researchgate.net/publication/343087867_ehailing_services_in_malaysia_current_practices_and_future_outlook)
- Indra Balachandran, Ibrahim Bin Hamzah, 2017. The Influence Of Customer Satisfaction On Ride-Sharing Services In Malaysia. 5(2), 184-196 <https://www.ftms.edu.my/journals/pdf/IJABM/Nov2017/184-196.pdf>
- Lee, Y. C., Wang, Y. C., Lu, S. C., Hsieh, Y. F., Chien, C. H., Tsai, S. B., & Dong, W. (2016). Empirical research on customer satisfaction study: a consideration of different levels of performance. *Journal of Springer Plus*, 5(1). <https://doi.org/10.1186/s40064-016-3208-z>
- Li, L., Ragavan, N. A., Patwary, A. K., & Baijun, W. (2022). Measuring patients' satisfaction toward health tourism in Malaysia through hospital environment, nutritional advice, and perceived value: A study on Chinese exchange students. *Frontiers in public health*, 10, 893439.
- Li, L., Wu, B., & Patwary, A. K. (2022). How marine tourism promote financial development in sustainable economy: new evidences from South Asia and implications to future tourism students. *Environmental Science and Pollution Research*, 29, 1155-1172.
- Li, L., Wu, B., & Patwary, A. K. (2022). The psychosocial factors affecting chinese Outbound Exchange and mobility students' academic performance during COVID-19. *Frontiers in psychology*, 13, 872516.
- Mohd Idros, N. A. N., Mohamed, H., & Jenal, R. (2019). Determinant factors of customer satisfaction for e-hailing service: A preliminary study. *Journal of Advances in Intelligent Systems and Computing*, 843(September 2020), 803-811. [https://doi.org/10.1007/978-3-319-99007-1\\_7](https://doi.org/10.1007/978-3-319-99007-1_7)

- Nur Zaimah Ubaidillah, Chan Yong Yi, Mohd Khairul Hisyam Hassan, Sharifah Sabrina Syed Ali, and Josephine Yau Tan Hwang, 2019. The Determinants of Generation Z Intention to Use the Grab E-Hailing Services, Vol. 9, No. 11, Pg. 483 – 495 [https://www.researchgate.net/profile/JosephineYau/publication/340451414\\_The\\_Determinants\\_of\\_Generation\\_Z\\_Intention\\_to\\_Use\\_the\\_Grab\\_EHailing\\_Services/link/s/5ef986ea45851550507b0931/The-Determinants-of-Generation-Z-Intention-to-Use-the-Grab-E-Hailing-Services.pdf](https://www.researchgate.net/profile/JosephineYau/publication/340451414_The_Determinants_of_Generation_Z_Intention_to_Use_the_Grab_EHailing_Services/link/s/5ef986ea45851550507b0931/The-Determinants-of-Generation-Z-Intention-to-Use-the-Grab-E-Hailing-Services.pdf)
- Nurul Farah Izzah Zailani, Albattat, Ahmad, Amirul Hakeem Sulaiman, Indah Adriana Abu Nazari, Nik Faisal Nik Nasirman, (2020). Factors influencing consumer perception on ride-sharing application services: a case study of grab car. 57(9), 2490-2495 [https://www.researchgate.net/publication/348899866\\_Factors\\_influencing\\_consumer\\_perception\\_on\\_ride-sharing\\_application\\_services\\_a\\_case\\_study\\_of\\_grab\\_car](https://www.researchgate.net/publication/348899866_Factors_influencing_consumer_perception_on_ride-sharing_application_services_a_case_study_of_grab_car)
- Patwary, A. K., Roy, B., Hoque, R., & Khandakar, M. S. A. (2019). Process of developing a community based tourism and identifying its economic and social impacts: An Empirical study on Cox's Bazar, Bangladesh. *Pakistan Journal of Humanities and Social Sciences*, 7(1), 1-13.
- Ridzuan Masri, 2021. Manipal International University, Malaysia. The Competitive Position of E-Hailing Giant in Asia Pacific Region: Challenges for Malaysian Startups, 1(1), 1-7 <https://ijbmcjournal.files.wordpress.com/2021/05/ijba-vol-1-1-12021.pdf>
- Ruzzakiah Jenal, Hazura Mohamed, Siti Aishah Hanawi & Nur Athirah Nabila Mohd Idros, (2021). User Satisfaction Index Of E-Hailing Services Based On Co-Creation Value. 99(10), 2445-2457. <http://www.jatit.org/volumes/Vol99No10/22Vol99No10.pdf>
- Service Quality Dimensions towards Customer's Satisfaction of Ride-Hailing Services in Kuala Lumpur, Malaysia. 7(5), 102-109 <https://www.ijrte.org/wp-services>
- Services: An Empirical Study among Private University Students in Klang Valley, Malaysia. 10(12), 796-785 [https://www.researchgate.net/publication/348176529\\_The\\_Ride\\_Hailing\\_Services\\_An\\_Empirical\\_Study\\_among\\_Private\\_University\\_Students\\_in\\_Klang\\_Valley\\_Malaysia](https://www.researchgate.net/publication/348176529_The_Ride_Hailing_Services_An_Empirical_Study_among_Private_University_Students_in_Klang_Valley_Malaysia)
- Sumethokula, P., Patwary, A. K., Srinuanpanc, B., Srinuanpand, C., Suwandee, P., Thammathikul, A., & Phanong, W. (2020). The potential of new tour repackaging for creative tourism among entrepreneurs in Nakhon Si Thammarat. *International Journal of Innovation, Creativity and Change*, 13(10), 1752-1771.
- Wu, B., Liu, S., Wang, J., Tahir, S., & Patwary, A. K. (2021). Assessing the mechanism of energy efficiency and energy poverty alleviation based on environmental regulation policy measures. *Environmental Science and Pollution Research*, 28, 40858-40870.
- Wu, B., Zhai, B., Mu, H., Peng, X., Wang, C., & Patwary, A. K. (2021). Evaluating an economic application of renewable generated hydrogen: A way forward for green economic performance and policy measures. *Environmental Science and Pollution Research*, 1-15.

# FACTOR INFLUENCING TOURIST SATISFACTION WHILE TRAVELING AMONG STUDENTS AT UNIVERSITI MALAYSIA KELANTAN

*Muhammad Hisham Bin Mohd Nawawi, Muhammad Aizat Bin Mohamad Sayoti, Muhammad Amir Izzat Bin Mohd Sharif, Muhammad Ammar Bin Mohd Arifin & \*Dr. Siti Salina Binti Saidin*

*Faculty of Hospitality, Tourism and Wellness, Universiti Malaysia Kelantan  
Corresponding email: salina.s@umk.edu.my*

---

## ABSTRACT

This study intends to investigate how amenities, attractions, and destination perception affect traveller satisfaction among students at Universiti Malaysia Kelantan. Students at the Universiti Malaysia Kelantan city campus received surveys. Using SPSS version 25, 135 data points were collected and subjected to descriptive analysis, reliability testing, and correlation testing. According to the study, there was a strong relationship between tourist satisfaction and attractions, amenities, and destination image. Future research might explore different variables, employ qualitative methodologies, and broaden the population under study.

**Keywords: Attraction, Facilities, Destination Image & Tourist Satisfaction**

---

## INTRODUCTION

The tourism sector is significant because it contributes significantly to the economies of both emerging and wealthy nations. The term "tourism" has undergone significant change over the past few decades (Vanhove, 2005). It is now widely acknowledged that it encompasses a dynamic transitory aspect (temporary travel), a static element (staying in a particular location aside from the tourist's regular place of employment and abode), and financial repercussions (facilities and services offered). According to a recent definition from UNWTO (2003), tourists are "people who travel to and stay in places outside their usual environment for more than twenty-four hours and not more than one consecutive year for leisure, business, or other purposes not related to the exercise of an activity remunerated from within the place visited."

### Significant of The Study

The goal of this study is to examine the relationship between creative work behavior and satisfaction, specifically organisational citizenship behavior and satisfaction of tourists and innovative work behavior and performance at work. For tourist journeys, researchers have examined tourism satisfaction in a variety of ways. This study's primary objective is to find parameters that influence consumer satisfaction with pre-tourism product components. This study employs a quantitative approach, using several data processing tests to demonstrate the validity of the hypothesis. The study's findings also indicate that many travellers from all main groupings of nations find the service level adequate.

## LITERATURE REVIEW

### Attraction

According to Suanmali (2014), an attraction is anything or everything that pulls tourists to a certain location. Examples of tourist attractions include natural attractions, cultural attractions, and leisure pursuits. According to Lascu et al. (2018), a site's popularity in the eyes of visitors is influenced by its attractions. These attractions include features of the natural world, such as breathtaking river views, parks, roads, underground formations and tunnels, and picturesque mountain and valley panoramas. Another type of attraction is entertainment and events, such as Western musicals, plays,

exhibits, cultural events, festivals, nightlife, and entertainment. This category may also include historical landmarks like historical, heritage, and antique buildings (Rajesh, 2014).

### **Facilities**

The broad variety of elements in a location that support and enable the expansion of the tourist business is referred to as facilities (Swarbrooke and Horner, 2001). Numerous viewpoints on the significance of infrastructure, tourist infrastructure, and recreational amenities have been highlighted in the literature. Hansen (1965) views infrastructure as a blend of economic and social overhead capital, much as Mera (1973). In contrast to economic capital, social capital emphasises developing human capital, particularly through publicly sponsored social services. Roads, bridges, and other productive endeavours are supported by economic capital. Using public health and education as examples. It refers to all the services visitors utilise before, during, and after their visits, according to Lohmann and Netto (2017).

### **Destination Image**

They concluded that analysing images only in terms of lists of attributes would not accurately capture the multidimensionality of ideas, and they recommended understanding images as consisting of components from three categories: attribute/holistic, functional/psychological and common/unique. As a result, some include new image components and produce more thorough builds. For example, Baloglu and Brinberg (1997) use a broad term from several authors: Image consists of people's thoughts, ideas and impressions about places or travel destinations. Crompton's formulation (1979) includes aspects of the emotive component, cognitive awareness, and simple evaluation.

### **Tourist Satisfaction**

Tourist satisfaction is often defined as travellers' favourable evaluations of their travel experiences, whereas travellers' irritation with their travel experiences is conveyed in negative reviews (Xu & Li, 2016). The outcome of a tourist's trip experiences at the destination is whether or not they met or exceeded their pre-trip expectations. Similarly, Chiu, Zeng, and Cheng (2016) asserted that "tourist satisfaction" relates to how visitors evaluate their prior views and expectations. When visitors' impression surpasses their initial expectations, they feel satisfied.

### **Research Hypothesis**

There is no formal hypothesis, and it is possible that the study's goal is to explore a particular subject thoroughly to produce a particular hypothesis or prediction that can be verified in subsequent investigations. An investigation may contain one or more hypotheses. The hypothesis of this research:

H1: There is a relationship between attraction and tourist satisfaction among Universiti Malaysia Kelantan students

H2: There is a relationship between facilities and tourist satisfaction among students at Universiti Malaysia Kelantan

H3: There is a relationship between destination image and tourist satisfaction among students at Universiti Malaysia Kelantan



## Research Framework

The three factors that make up the independent variable that will be proposed are attraction factor, accessibility factor, and destination image factor is a factor influencing tourist satisfaction while travelling among students at Universiti Malaysia Kelantan.

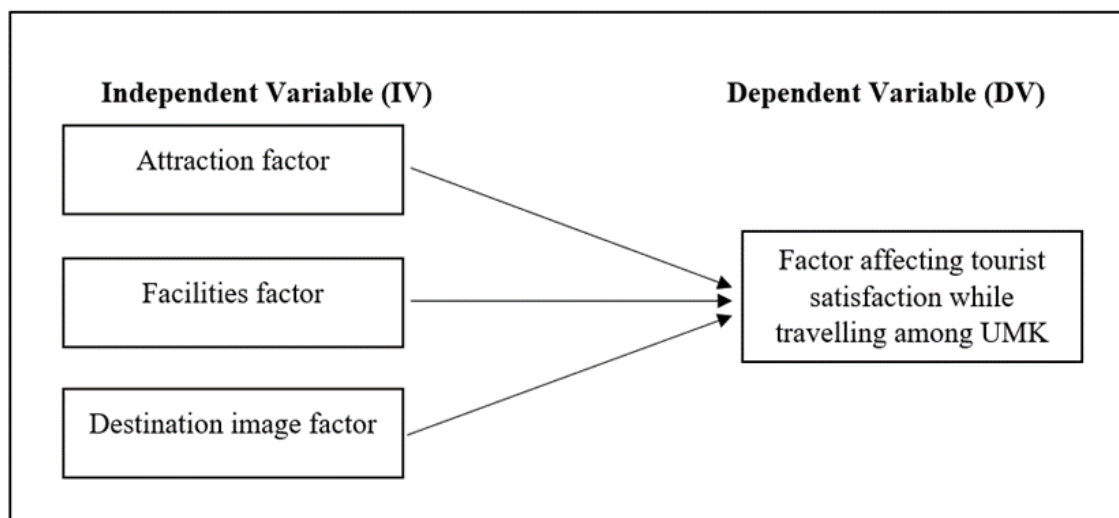

Figure 1: Conceptual Framework

## METHODOLOGY

It is defined as using research information while applying something to a planned outcome. The research process, data collection techniques, sampling plan, and presented work form a large part of the analytical approach. From the above statement, it can be concluded that what conveys the definition of research is a methodical and objective effort to gather or collect correct and useful facts. The process of reviewing and researching studies systematically and fairly is known as methodology.

### Research Design

The conceptual model that this study proposes adequately describes the perception of quality destinations in tourist satisfaction by combining multiple research models. The link between gender and visitation frequency will affect both of these characteristics, which is another crucial issue to take into account.

### Data Collection

Primary data, or information acquired directly from sources by researchers utilising an online survey, will be used in the research project to gather data. In this study, respondents were given questionnaires to complete in order to gather primary data. The survey, usually referred to as an online questionnaire, will be disseminated online.

The purpose of this analysis was stated in the covering letter included with the form that was distributed to the respondents. As a result, respondents can understand the motivation and purpose of this study, allowing them to generate more accurate data. The questionnaire was distributed to 100-350 respondents of tourist satisfaction while traveling.

## Sampling

This random sampling method refers to the collection of information to participate in research studies from members of the population (Sekaran, 2009). Therefore, by using random sampling, the number of people is large, including all individuals. Random sampling method was used for sampling in this study.

This study simulates the relationship between tourist satisfaction and destination attributes and looks at the extent to which emotional involvement mediates between tourist satisfaction and destination attributes. Studies have examined the antecedents of the consequences of tourists' satisfaction with their chosen destination.

## Data Analysis

This study simulated the factor affecting tourist satisfaction while travelling among UMK students. The findings revealed that attraction factors, accessibility and destination image factor influenced tourist satisfaction directly and indirectly.

## FINDINGS

### Demographic analysis

Demography is the study of populations, including their size, composition, and changes across time. It is relevant in this context because it has to do with counting births, deaths, emigration, and other significant occurrences that directly affect population fluctuations and, in turn, have an impact on factors like age distribution and population size and composition. There are numerous ways to get information and data about visitor pleasure. The relationships between demographic characteristics like age and life-changing occurrences like births or socioeconomic variables that affect these occurrences like the effect of fertility rates on the degree of child dependence on the working population and demand for educational services are some other issues in demographic analysis.

### GENDER/JANTINA

		Frequency	Percent	Valid Percent	Cumulative Percent
Valid	Female/Perempuan	96	61.9	61.9	61.9
	Male/Lelaki	59	38.1	38.1	100.0
	Total	155	100.0	100.0	

### RACE/BANGSA

		Frequency	Percent	Valid Percent	Cumulative Percent
Valid	Chinese/Cina	5	3.2	3.2	3.2
	Indian/India	5	3.2	3.2	6.5
	Malay/Melayu	134	86.5	86.5	92.9
	Other/Lain-lain	11	7.1	7.1	100.0
	Total	155	100.0	100.0	

#### AGE/UMUR

		Frequency	Percent	Valid Percent	Cumulative Percent
Valid	21-25 year old/21-25 tahun	103	66.5	66.5	66.5
	21-30 year old/21-30 tahun	35	22.6	22.6	89.0
	26-30 year old/26-30 tahun	5	3.2	3.2	92.3
	31-35 year old/31-35 tahun	4	2.6	2.6	94.8
	31-40 year old/31-40 tahun	1	.6	.6	95.5

<b>35 year old and above/35 tahun dan keatas</b>	<b>2</b>	<b>1.3</b>	<b>1.3</b>	<b>96.8</b>
<b>Less than 20 year old/kurang dari 20 tahun</b>	<b>5</b>	<b>3.2</b>	<b>3.2</b>	<b>100.0</b>
<b>Total</b>	<b>155</b>	<b>100.0</b>	<b>100.0</b>	

#### MARITAL STATUS/STATUS PERKHAWINAN

		<b>Frequency</b>	<b>Percent</b>	<b>Valid Percent</b>	<b>Cumulative Percent</b>
<b>Valid</b>	<b>Married/Berkhawan</b>	<b>11</b>	<b>7.1</b>	<b>7.1</b>	<b>7.1</b>
	<b>Single/Bujang</b>	<b>144</b>	<b>92.9</b>	<b>92.9</b>	<b>100.0</b>
	<b>Total</b>	<b>155</b>	<b>100.0</b>	<b>100.0</b>	

#### EDUCATIONAL LEVEL/PERINGKAT PENDIDIKAN

		<b>Frequency</b>	<b>Percent</b>	<b>Valid Percent</b>	<b>Cumulative Percent</b>
<b>Valid</b>	<b>Bachelor of Degree/Sarjana Muda</b>	<b>133</b>	<b>85.8</b>	<b>85.8</b>	<b>85.8</b>
	<b>Diploma</b>	<b>15</b>	<b>9.7</b>	<b>9.7</b>	<b>95.5</b>
	<b>Doctor of Philosophy/Doktor Falsafah</b>	<b>5</b>	<b>3.2</b>	<b>3.2</b>	<b>98.7</b>

<b>Secondary School/Sekolah Menengah</b>	<b>2</b>	<b>1.3</b>	<b>1.3</b>	<b>100.0</b>
<b>Total</b>	<b>155</b>	<b>100.0</b>	<b>100.0</b>	

### Descriptive analysis

To highlight the most important aspects of the data in an organisation, a descriptive statistic is utilised. There are enthralling insights that are divided into proportions of local predilection and proportions of inconstancy. Local propensity proportions are made up of mean, median, and mode, whereas fluctuation proportions are made up of standard deviation, change, base and most extreme variables, kurtosis, and skewness.

Data must be studied with these purposes in mind since, in the eyes of the content analyst, they are representations of meanings expressed through texts, images, and other expressions rather than actual events (Krippendorff, 2004).

### DV: Tourist Satisfaction

#### Descriptive Statistics

	N	Minimum	Maximum	Mean	Std. Deviation
I think there are a lot of tourism places around Malaysia/Saya rasa terdapat banyak tempat pelancongan di sekitar Malaysia	155	1	5	4.45	.968
I think the price of traveling is cheap for me/Saya rasa harga melancong adalah murah bagi saya	155	1	5	3.37	1.038

I prefer to use my time in good way like traveling/Saya lebih suka menggunakan masa saya dengan cara yang baik seperti melancong	155	1	5	4.05	.963
I travel because want to release stress/Saya melancong untuk menghilangkan rasa stress	155	1	5	4.20	.929
Information from mouth-to-words influences travel for me/Maklumat dari mulut ke perkataan mempengaruhi perjalanan untuk saya	155	1	5	3.94	1.064
Valid N (listwise)	155				

#### IV1: Attraction

#### Descriptive Statistics

N	Minimum	Maximum	Mean	Std. Deviation
---	---------	---------	------	----------------

Promoting attraction via social media such as Instagram, Twitter and WhatsApp attract me to travel/Mempromosikan tarikan melalui media sosial seperti Instagram, Twitter dan WhatsApp menarik saya untuk melancong	155	1	5	4.43	.868
Cultural differences make me want to know them and visit them/Perbezaan budaya membuatkan saya ingin mengenali mereka dan melawat mereka	155	1	5	4.27	.892
I choose the destination because of the high quality of the universe, which seems to be a big attraction for visitors when choosing a vacation spot/Saya memilih sesuatu destinasi itu kerana kualiti alam semesta yang tinggi, yang menjadi tarikan utama pengunjung apabila memilih tempat percutian	155	1	5	4.28	.930

I travel because i am attracted to historical places/Saya melancong kerana saya tertarik dengan tempat bersejarah	155	1	5	4.03	.980
I think food is one of the factors I prefer to travel/Saya rasa makanan adalah salah satu faktor saya lebih suka melancong	155	1	5	4.31	.951
Valid N (listwise)	155				

## IV2: Facilities

### Descriptive Statistics

	N	Minimum	Maximum	Mean	Std. Deviation
There are many good facilities for traveling/Terdapat banyak kemudahan fasiliti yang baik untuk melancong	155	1	5	4.04	.973
I did a survey for convenience in social media before traveling/Saya membuat tinjauan untuk kemudahan fasiliti pelancongan dalam media sosial sebelum melancong	155	1	5	4.26	.933



Facilities are important for comfort when on vacation/Kemudahan fasiliti di tempat percutian penting untuk keselesaan ketika bercuti	155	1	5	4.45	.913
I think a comfortable facility is one factor while traveling/Saya rasa kemudahan fasiliti yang selesa adalah salah satu faktor semasa melancong	155	1	5	4.43	.918
Various facilities make me attractive to travel/Pelbagai kemudahan membuatkan saya menarik untuk melancong	155	1	5	4.42	.829
Valid N (listwise)	155				

### IV3: Destination Image

#### Descriptive Statistics

N	Minimum	Maximum	Mean	Std. Deviation
---	---------	---------	------	----------------

I would be proud to tell other people about Malaysia/Saya akan berbangga untuk memberitahu orang lain tentang Malaysia	155	1	5	4.52	.792
In general, i have a great perception of the value of my holiday in Malaysia/Secara umumnya, saya mempunyai persepsi yang hebat tentang nilai percutian saya di Malaysia	155	1	5	4.34	.877
Malaysia has clean and organized beaches/Malaysia mempunyai pantai yang bersih dan teratur	155	1	5	3.94	1.017
Malaysia has freash and oxygen-rich air/Malaysia mempunyai udara segar dan kaya dengan oksigen	155	1	5	4.08	.993
Good variety of plant and animals/Pelbagai haiwan dan tumbuhan yang baik	155	1	5	4.28	.881
Valid N (listwise)	155				

### Reliability analysis

A reliability system is used to assess a system's stability and overall performance over a specified time frame and under various distinct testing scenarios. The Cronbach Alpha reliability coefficient, which estimates the Cronbach Alpha coefficient, is validated in order to obtain and gain the reliability of the tourist satisfaction measurement, indicating that an instrument is impartial and ensuring that it is consistent to measure various items at various times.

Variable	Cronbach's Alpha	No of Item	N
Tourist Satisfaction	0.828	5	155
Attraction	0.908	5	155
Facilities	0.906	5	155
Destination Image	0.893	5	155
All Variable	0.937		155

### Pearson correlation

The temporary correlation coefficient of the product was also known as the Pearson correlation tourist attraction. It is represented by  $r$  in a sample. Following that, a sample of the population was taken and described. With a non-unit scale, a value between 1 and +1 will be utilised to determine the coefficient. When the positive correlation coefficient had a positive sign, the positive correlation was also present. If the correlation coefficient was negative, there would have been a negative correlation (Philip, 2012).

Hypothesis	Pearson's correlation results
H1: There is a significant relationship between attraction and tourist satisfaction.	$r = 0.652, p < 0.01$ Moderate
H2: There is a significant relationship between facilities and tourist satisfaction.	$r = 0.629, p < 0.01$ Moderate
H3: There is a significant relationship between food related motivation and food satisfaction	$r = 0.408, p < 0.01$ Low

## **DISCUSSION AND RECOMMENDATION**

The facilities variable had the highest mean value in the descriptive analysis for the independent variables, at 4.3187, followed by the attraction variable at 4.2619. Destination image 4.2310 had the lowest mean value among the independent factors. The dependent variable's mean value was 4.0013. It may be concluded that amenities affected UMK students' traveller satisfaction.

The researchers used the Correlation Analysis to gauge the linear relationship between the two variables designated as the study's goals. The correlation for hypothesis 1, which refers to facilities, is 0.652 (moderately positive). The correlation value for proposition number two, which is about attraction, is 0.629, which is somewhat positive. The correlation result for hypothesis three, which is the destination image, is 0.408 (low positive).

Since this study solely focused on UMK students, it proposes that more research may be done generally on non-specialized visitors vacationing in Malaysia to determine if there are any common findings. If this study were to be conducted on international visitors to Malaysia, the findings could be different. Therefore, in addition to UMK students, there are international visitors who will respond to the questionnaire. Additionally, just three factors that affect how Malaysian tourists behave are the subject of the current study. Other significant factors do, however, illustrate how Malaysian visitors behave. Future researchers will be able to suggest new variables, such economic factors, to include fresh information into their research. There are just 155 samples in this study, hence the market can be deemed tiny. The amount will be enough and acceptable, and a bigger sample size can be utilised to organise the millions of domestic visitors from Malaysia, claim Krejcie & Morgan (1970). Therefore, future researchers should expand their sample size in order to improve the study's accuracy and dependability.

## **CONCLUSION**

In order to better understand how students from Universiti Malaysia Kelantan perceive their travel experiences, this survey was done. Important variables (independent variable), such as attractions, amenities, and destination image, have an impact on tourist satisfaction (dependent variable) among students at Universiti Malaysia Kelantan. To gather all data and facts, researchers also employ a quantitative technique. The findings of the questionnaire survey were examined using a number of techniques, including frequency analysis, descriptive analysis, reliability analysis, and correlation analysis. The results from the previous chapter and all the data from the questionnaire were examined using the statistical programme SPSS 25 (Statistical Package for the Social Science). This programme was chosen by the researchers because it made it simple to obtain all the results. Additionally, this study offers shortcomings and suggestions that could be helpful for future investigations.

## **REFERENCES**

- Agapito, D., Oom do Valle, P., & da Costa Mendes, J. (2013). The cognitive-affective-conative model of destination image: A confirmatory analysis. *Journal of Travel & Tourism Marketing*, 30(5), 471-481.
- Akter, M., Sadekin, M. N., & Patwary, A. K. (2020). An Empirical Study on Students' Satisfaction from Mawlana Bhashani Science & Technology University, Bangladesh. *Review of Economics and Development Studies*, 6(2), 363-379.
- Al-Ababneh, M. M. (2013). Service quality and its impact on tourist satisfaction. *Institute of Interdisciplinary Business Research*, 164.

- Alom, S., Patwary, A. K., & Khan, M. M. H. (2019). Factors affecting the turnover intention of Bangladeshi migrants in the United Arab Emirates: An empirical study on the hotel industry. *International Journal of Innovation, Creativity and Change*, 8(3), 344-360.
- Bianco, C. & France, K. (2019). Balancing the benefits and risks of tourism attraction construction. *Mediterranean Journal of Social Sciences*, 10(4), 153.
- Biswas, C., Omar, H., & Rashid-Radha, J. Z. R. R. (2020). THE IMPACT OF TOURIST ATTRACTIONS AND ACCESSIBILITY ON TOURISTS'SATISFACTION: THE MODERATING ROLE OF TOURISTS'AGE. *Geo Journal of Tourism and Geosites*, 32(4), 1202-1208.
- Biswas, C., Omar, H., & Rashid-Radha, J. Z. R. R. (2020). THE IMPACT OF TOURIST ATTRACTIONS AND ACCESSIBILITY ON TOURISTS'SATISFACTION: THE MODERATING ROLE OF TOURISTS'AGE. *Geo Journal of Tourism and Geosites*, 32(4), 1202-1208.
- Bowen, D., & Clarke, J. (2002). Reflections on tourist satisfaction research: Past, present and future. *Journal of Vacation Marketing*, 8(4), 297-308. <https://doi.org/10.1177/135676670200800401>
- Del Bosque, I. R., & San Martín, H. (2008). Tourist satisfaction a cognitive-affective model. *Annals of tourism research*, 35(2), 551-573.
- Dmitrović, T., Cvelbar, L. K., Kolar, T., Brenčič, M. M., Ograjenšek, I., & Žabkar, V. (2009). Conceptualising tourist satisfaction at the destination level. *International Journal of Culture, Tourism and Hospitality Research*. <https://www.emerald.com/insight/content/doi/10.1108/17506180910962122/full/html>
- Fengmin, Z., Baijun, W., Jiangtao, B., Li, L., & Patwary, A. K. (2022). Investigating revisit intention of medical tourists in China through nutritional knowledge, perceived medical quality, and trust in the physiologist: A recommendation on health tourism policy measures. *Frontiers in Public Health*, 10, 893497.
- Hazbar, A. M. H., Alem Mohammed, A., & Karim, A. K. A. (2019). An Empirical Study of Factors Influencing hotel customers' online booking Intention. *مجلة العلوم التربوية و الدراسات الإنسانية*, (5), 1-17.
- Hidayatullah, S., Wibowo, R., Astuti, W., Alvianna, S., & Setioko, M. D. Analysis of the Influence of Tourist Destinations and Service Quality on Tourist Satisfaction Visiting the Jawa Timur Park in the New Normal Era.
- Huang, S., Weiler, B., & Assaker, G. (2015). Effects of interpretive guiding outcomes on tourist satisfaction and behavioral intention. *Journal of Travel Research*, 54(3), 344-358. <https://journals.sagepub.com/doi/abs/10.1177/0047287513517426>
- Kumar, T. (2017). Image optimisation for search engine results. Retrieved from <https://blog.longpath.in/image-optimization-for-search-engine-result/>
- Li, L., Ragavan, N. A., Patwary, A. K., & Baijun, W. (2022). Measuring patients' satisfaction toward health tourism in Malaysia through hospital environment, nutritional advice, and perceived value: A study on Chinese exchange students. *Frontiers in public health*, 10, 893439.

- Li, L., Wu, B., & Patwary, A. K. (2022). How marine tourism promote financial development in sustainable economy: new evidences from South Asia and implications to future tourism students. *Environmental Science and Pollution Research*, 29, 1155-1172.
- Li, L., Wu, B., & Patwary, A. K. (2022). The psychosocial factors affecting chinese Outbound Exchange and mobility students' academic performance during COVID-19. *Frontiers in psychology*, 13, 872516.
- Martens, David. "The Destination Visual Experience: Use Creative Visuals to Engage Consumers." Ascend2, 2017, [www.ascend2.com/insights/case-studies/visual-experience-engage-consumers/](http://www.ascend2.com/insights/case-studies/visual-experience-engage-consumers/).
- Martina G.Gallarza (2002). Destination image: Towards a Conceptual Framework. Retrieved from <https://www.sciencedirect.com/science/article/abs/pii/S0160738301000317>
- Nguyen, T.C. et al. (2019). Image optimisation: principles and techniques for content publishers and marketers. Retrieved from <https://searchengineland.com/image-optimization-principles-techniques-content-publishers-marketers-285147>
- Patwary, A. K., Roy, B., Hoque, R., & Khandakar, M. S. A. (2019). Process of developing a community based tourism and identifying its economic and social impacts: An Empirical study on Cox's Bazar, Bangladesh. *Pakistan Journal of Humanities and Social Sciences*, 7(1), 1-13.
- Purwanto, A., Novitasari, D., & Asbari, M. (2022). Tourist Satisfaction and Performance of Tourism Industries: How The Role of Innovative Work Behaviour, Organisational Citizenship Behaviour?. *Journal of Industrial Engineering & Management Research*, 3(1), 1-12. <https://www.jiemar.org/index.php/jiemar/article/view/246>
- ResearchGate is a European commercial social networking site for scientists and researchers to share papers, ask and answer questions, and find collaborators [https://www.researchgate.net/publication/303554285\\_Tourists'\\_Satisfaction\\_with\\_a\\_Destination\\_An\\_Investigation\\_on\\_Visitors\\_to\\_Langkawi\\_Island](https://www.researchgate.net/publication/303554285_Tourists'_Satisfaction_with_a_Destination_An_Investigation_on_Visitors_to_Langkawi_Island)
- Shahrivar, R. B. (2012). Factors that influence tourist satisfaction. *Journal of Travel and Tourism Research (Online)*, 12(1), 61.
- Springer Science+Business Media, commonly known as Springer, is a German multinational publishing company of books, e-books and peer-reviewed journals in science, humanities, technical and medical publishing [https://link.springer.com/content/pdf/10.1007%2F978-3-319-01669-6\\_12-1.pdf](https://link.springer.com/content/pdf/10.1007%2F978-3-319-01669-6_12-1.pdf)
- Sumethokula, P., Patwary, A. K., Srinuanpanc, B., Srinuanpand, C., Suwandee, P., Thammathikul, A., & Phanong, W. (2020). The potential of new tour repackaging for creative tourism among entrepreneurs in Nakhon Si Thammarat. *International Journal of Innovation, Creativity and Change*, 13(10), 1752-1771.
- Svetlana Stepchenkova & Juline E. Mills (2010) Destination Image: A Meta-Analysis of 2000–2007 Research, *Journal of Hospitality Marketing & Management*, 19:6, 575-609, DOI: 10.1080/19368623.2010.493071

- Tasci, A. D., Gartner, W. B., & Cavusgil, S. T. (2007). Conceptualization and Operationalization of Destination Image. *Journal of Hospitality & Tourism Research*, 31(2), 194–223. <https://doi.org/10.1177/1096348006297290>
- Wu, B., Liu, S., Wang, J., Tahir, S., & Patwary, A. K. (2021). Assessing the mechanism of energy efficiency and energy poverty alleviation based on environmental regulation policy measures. *Environmental Science and Pollution Research*, 28, 40858-40870.
- Wu, B., Zhai, B., Mu, H., Peng, X., Wang, C., & Patwary, A. K. (2021). Evaluating an economic application of renewable generated hydrogen: A way forward for green economic performance and policy measures. *Environmental Science and Pollution Research*, 1-15.
- Yoon, Y. and Uysal, M. (2005) 'An Examination of the Effects of Motivation and Satisfaction on Destination Loyalty: A Structural Model', *Tourism Management* 26(1): 45—56. <https://www.sciencedirect.com/science/article/pii/S0261517703002000>

## **Factors Determining Young Tourists' Intention To Use Smart Tourism Technology In Kelantan.**

**Muhammad Ammirul Harith Bin Nawawi, Muhammad Aqil Bin Abd. Rahman, Muhammad Arif Hakimi Bin Abdullah, Muhammad Ariff Bin Baharudin & Siti Salina Saidin\***

Faculty of Hospitality, Tourism and Wellness, University Malaysia Kelantan

Corresponding email : [salina.s@umk.edu.my](mailto:salina.s@umk.edu.my)

---

### **ABSTRACT**

The development of information and communication technology (ICT), including social media, mobile technology, artificial intelligence, and the Internet of Things, has completely changed the tourism sector. Focuses on young tourists because they use the Smart Tourism Technology almost in their daily life and become a need for them. For example, when people travel to other places or destinations, the environment will be changed regarding the current destination. They have to adapt with the new environment and also new cultures depending on their location. Aims of study to examine the relationship between smart tourism technologies with accessibility, security and informativeness among young tourists in Kelantan. This study has used convenience sampling techniques which are quantitative studies to ensure the intention is guaranteed. A total 217 respondents participated to answer all the questions in this survey. As a result, the Accessibility variable had the highest mean value in the descriptive analysis and findings for the independent variables which is 4.1963, this can be seen that the most important factor among the other factors is Accessibility.

**Keywords : Smart Tourism Technology, Smart Tourism, Intentions Towards STT, Security, Informativeness, Accessibility.**

---



## **INTRODUCTION**

The main goal of this study is to better understand how smart tourism technology may better serve young tourists in Kelantan by emphasizing accessibility, information, and security. The purpose of this study was to determine the extent to which smart tourism technology has an impact on young tourists from Kelantan. In fact, this study also aims to look into how participants use smart tourism technologies when traveling in Kelantan. The tourists of the study, statement of the problem, objective of the study, research question, importance of the study, scope of the study and chapter summary follow the chapter introduction in this study.

## **SIGNIFICANCE OF STUDY.**

There is growing interest in the educational element of tourism as the field of study of tourism develops and as the number of higher education institutions devoted to tourism continues to grow globally. As the body of knowledge on the subject of tourism is now growing, research into education-related fields is also rising (D Airey, J Tribe, 2006). Information and communication technology (ICT)-based resources make it easier for students to access travel and hospitality-related goods, services, locations, and experiences. By enhancing and expanding these resources, urban intelligence is improved and student participation is raised. Title of the study is Factors that Influence Young Tourists' Intention to Use Smart Tourism Technology in Kelantan. Understanding how students use tourist technology as a platform to help them develop ideas and knowledge is the goal of this project. This study also examines how students respond while deciding to participate in services and physical activities. The results of this study show how important smart tourism technology is to youthful travelers in Kelantan.

## LITERATURE REVIEW

### 1. Accessibility.

The term "accessibility" refers to how a person may use various types of SST to access and use the information offered at the destination. To be accessible or accessible, travelers and technologies must be able to interact with, reach, and be accessed by other organizations (Kim and Garrison, 2009).

### 2. Informativeness.

The extent to which a website offers users the information they require to be seen as knowledgeable and helpful is characterized as informativeness, according to Pavlou et al. (2007).

### 3. Security.

When doing different transactions, security refers to how private personal information is. (Park, YA; Gretzel, U., 2007). The protection of personal information when utilizing different forms of STTs is referred to as security.

### 4. Intention to use Smart Tourism Technology. (STT)

"Smart tourism technology" (STT), as defined by Yoo et al. (2017), is any interactive technology that is used by various tourists to gather data, carry out transactions, communicate, and create content. According to Neuhofer et al. (2015), "smart tourism" is a collection of applications that enhance the traveler's experience and offer value to customers.

## Research Hypothesis

It implies that a relationship between an independent variable and a dependent variable is reliable. Therefore, according to the research:

**H1** : To examine the relationship between informativeness with intention to use Smart Tourism Technology among tourist in Kelantan.

**H2** : To examine the relationship between security with intention to use Smart Tourism Technology among tourist in Kelantan.

**H3** : To examine the relationship between accessibility with intention to use Smart Tourism Technology among tourist in Kelantan.

## Research Framework

Figure 1 below shows the conceptual framework that was used in this study.

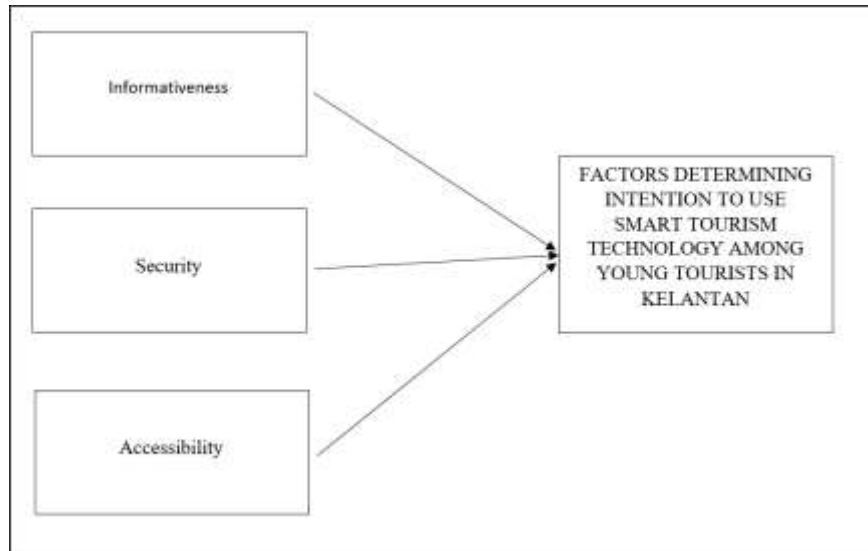

**Figure 1 Conceptual framework of informativeness, security and accessibility toward intentions to use smart tourism technology among young tourists in Kelantan.**

## METHODOLOGY

It is described as the process of applying knowledge from research to a predetermined result. A significant portion of the analytical approach is formed by the study methodology, data gathering strategies, sample design, and presented work. As may be inferred from the aforementioned statement, research is an organized, objective activity with the goal of acquiring reliable information. The term "methodology" refers to the methodical, impartial procedure of evaluating and investigating studies.

## **Research Design**

When conducting a study, a certain approach known as research design must be followed that specifies the time frame, the data sources, and the conditions under which the data will be acquired (Cooper & Schindler, 2008). Making sure that the data-based evidence can effectively and convincingly address the research topic is the goal of study design (Vaus, 2001). Because it is simple to get data from people based on our independent variable and dependent variables, we used a quantitative research design for our study.

## **Data Collection**

The collection of data is essential to statistical analysis. As the primary technique of data collection for this research, respondents answered the questionnaires. The package of surveys will include a cover letter. The content of the respondent's research objective will be shown on the top page. This will inform the responder about the motivation behind and goal of our study. There are 5 checkboxes in the area that respondents must complete in order to provide a response, and the data they provide is what we use for the study. Young travelers in Kelantan get the questionnaire.

## **Sampling**

Refers to (Alvi, 2016), sampling is the process of removing a sample from a population. Sampling can be used to infer a population or to generalize a theory (Hamed, 2016). Using this random sample approach, the information about the population that willing to participate in the research is acquired (Sekaran, 2009). Since there are several people, a random sampling is employed to ensure that each person is considered. Cluster random sampling was used for this study's sample selection.

## **Data Analysis.**

The process of analyzing data entails meticulously scrutinizing each element of the information provided while using logic and science to the evaluation. Conducting an exploratory test

has a wide range of alternatives, including this form of inspection. Data obtained, reviewed, and then deconstructed from numerous sources are used to frame a finding or end type. Explicit information research techniques include information mining, content evaluations, business insight, and information perceptions. The data acquired were assessed using the Statistical Package for the Social Science Version 24(SPSS). A complete range of statistical tools, such as IBM SPSS version 24, is available for processing statistical data and producing a variety of outputs in order to respond to an objective investigation.

## **FINDINGS.**

### **Demographic Analysis**

The fundamental analysis of this investigation comprised a frequency analysis. The information from Section A of the questionnaire includes inquiries on the respondents' gender, age, race, status, level of education, and occupation. The respondents' race and ethnicity were two additional demographic characteristics. The respondents' demographic characteristics were shown using a table and a pie chart.

Table 1 : Descriptive analysis for Demographic Profile

		<b>GENDER</b>			
		<b>Frequenc</b>		<b>Valid</b>	<b>Cumulative</b>
		<b>y</b>	<b>Percent</b>	<b>Percent</b>	<b>Percent</b>
<b>Valid</b>	<b>Female</b>	<b>178</b>	<b>82.0</b>	<b>82.0</b>	<b>82.0</b>
	<b>Male</b>	<b>39</b>	<b>18.0</b>	<b>18.0</b>	<b>100.0</b>
<b>Total</b>		<b>217</b>	<b>100.0</b>	<b>100.0</b>	

### RACE

		Frequenc y	Percent	Valid Percent	Cumulative Percent
Valid	Chinese	2	.9	.9	.9
	Indian	2	.9	.9	1.8
	Malay	203	93.5	93.5	95.4
	Others	10	4.6	4.6	100.0
	Total	217	100.0	100.0	

### AGE

		Frequenc y	Percent	Valid Percent	Cumulative Percent
Valid	21-30 years old	199	91.7	91.7	91.7
	Less than 20 years old	5	2.3	2.3	94.0
	More than 30 Years old	13	6.0	6.0	100.0
	Total	217	100.0	100.0	

### MARITAL STATUS

		Frequenc y	Percent	Valid Percent	Cumulative Percent
<b>Valid</b>	<b>Married</b>	19	8.8	8.8	8.8
	<b>Single</b>	198	91.2	91.2	100.0
	<b>Total</b>	217	100.0	100.0	

### EDUCATIONAL LEVEL

		Frequenc y	Percent	Valid Percent	Cumulative Percent
<b>Valid</b>	<b>Bachelor of Degree</b>	193	88.9	88.9	88.9
	<b>Diploma</b>	11	5.1	5.1	94.0
	<b>Master Degree</b>	9	4.1	4.1	98.2
	<b>Primary School</b>	1	.5	.5	98.6
	<b>Secondary School</b>	3	1.4	1.4	100.0
	<b>Total</b>	217	100.0	100.0	

## OCCUPATION

	Frequency	Percent	Valid Percent	Cumulative Percent
<b>Valid Employed</b>	24	11.1	11.1	11.1
<b>Student</b>	192	88.5	88.5	99.5
<b>Unemployed</b>	1	.5	.5	100.0
<b>Total</b>	217	100.0	100.0	

### Descriptive Analysis

A descriptive statistic is used in an organisation to highlight the most important aspects of the data. Remarkable reports are divided into proportions of local predilection and proportions of inconstancy. The components of local propensity proportions are mean, median, and mode, whereas the components of fluctuation proportions are standard deviation, change, base and most extreme factors, kurtosis, and skewness.

Table 2 : Descriptive analysis for Intention to Use Smart Tourism

### DV: Intention to Use Smart Tourism

	N	Minimum	Maximum	Mean	Std. Deviation
<b>I can easily find smart tourism technology</b>	217	1	5	3.94	.803



<b>I can easily use smart tourism technology apps and websites.</b>	<b>217</b>	<b>1</b>	<b>5</b>	<b>4.04</b>	<b>.741</b>
<b>I can access smart tourism technology apps and websites at everywhere and anytime</b>	<b>217</b>	<b>1</b>	<b>5</b>	<b>4.13</b>	<b>.711</b>
<b>I have quick access to smart tourism technologies from a number of other similar apps and websites</b>	<b>217</b>	<b>1</b>	<b>5</b>	<b>4.00</b>	<b>.782</b>
<b>I can search without a complicated sign-up process while using smart tourism technology</b>	<b>217</b>	<b>1</b>	<b>5</b>	<b>3.97</b>	<b>.841</b>
<b>Valid N (listwise)</b>	<b>217</b>				

Table 3 : Descriptive analysis for Accessibility

**IV1: Accessibility**

	<b>N</b>	<b>Minimum</b>	<b>Maximum</b>	<b>Mean</b>	<b>Std. Deviation</b>
<b>Do you use smart tourism technology while traveling</b>	<b>217</b>	<b>2</b>	<b>5</b>	<b>4.06</b>	<b>.780</b>
<b>Does smart tourism technology help in planning trip</b>	<b>217</b>	<b>1</b>	<b>5</b>	<b>4.24</b>	<b>.686</b>
<b>Using smart tourism technology help me reach my destination conveniently</b>	<b>217</b>	<b>1</b>	<b>5</b>	<b>4.24</b>	<b>.699</b>
<b>Using smart tourism technology increase my interest to visit the place</b>	<b>217</b>	<b>1</b>	<b>5</b>	<b>4.25</b>	<b>.677</b>

<b>Using smart tourism technology can prevent from congestion while traveling</b>	<b>217</b>	<b>1</b>	<b>5</b>	<b>4.05</b>	<b>.832</b>
<b>Valid N (listwise)</b>	<b>217</b>				

Table 4 : Descriptive analysis for Informativeness

**IV2: Informativeness**

	<b>N</b>	<b>Minimum</b>	<b>Maximum</b>	<b>Mean</b>	<b>Std. Deviation</b>
<b>I can find relevant information about the travel destination by using smart tourism technology</b>	<b>217</b>	<b>1</b>	<b>5</b>	<b>4.31</b>	<b>.675</b>
<b>Smart tourism and technology apps and website are helpful for evaluating the destination and the trip</b>	<b>217</b>	<b>1</b>	<b>5</b>	<b>4.23</b>	<b>.695</b>

<b>Smart tourism technology enable me to complete my trips with the full information that has provided</b>	<b>217</b>	<b>1</b>	<b>5</b>	<b>4.14</b>	<b>.739</b>
<b>I can reduce my concern about my trip by using smart tourism technology apps and websites</b>	<b>217</b>	<b>2</b>	<b>5</b>	<b>4.12</b>	<b>.707</b>
<b>It easy to share tourism information content on smart tourism application and website</b>	<b>217</b>	<b>2</b>	<b>5</b>	<b>4.19</b>	<b>.650</b>
<b>Valid N (listwise)</b>	<b>217</b>				

Table 5 : Descriptive analysis for Security

### IV3: Security

<b>N</b>	<b>Minimum</b>	<b>Maximum</b>	<b>Mean</b>	<b>Std. Deviation</b>
----------	----------------	----------------	-------------	-----------------------

<b>When i use smart tourism technology, i believe my privacy is protected</b>	<b>217</b>	<b>2</b>	<b>5</b>	<b>3.73</b>	<b>.801</b>
<b>Smart tourism technology provides adequate security to protect my personal information</b>	<b>217</b>	<b>2</b>	<b>5</b>	<b>3.77</b>	<b>.759</b>
<b>I have doubt about how well my privacy is protected when i use smart tourism technology application and websites</b>	<b>217</b>	<b>1</b>	<b>5</b>	<b>3.87</b>	<b>.874</b>
<b>I am concerned with the security of sensitive information when i use tourism websites and application</b>	<b>217</b>	<b>1</b>	<b>5</b>	<b>4.18</b>	<b>.711</b>

<b>My personal information be misused to illegal access when using smart tourism technology</b>	<b>217</b>	<b>1</b>	<b>5</b>	<b>3.74</b>	<b>.947</b>
<b>Valid N (listwise)</b>	<b>217</b>				

### Reliability analysis

Utilizing reliability analysis, the surveys' dependability was evaluated. The reliability and internal consistency of the data were examined using Cronbach's Alpha analysis. According to Hair et al.'s (2007) Rules of Thumb for Cronbach's Alpha coefficient size, see the table below.

Table 6 : Result of Reliability analysis

<b>Variables</b>	<b>Number of Item</b>	<b>Cronbrach's Alpha Coefficient</b>	<b>Strength of Association.</b>
<b>Accessibility</b>	<b>5</b>	<b>0.644</b>	<b>Moderate</b>
<b>Informativeness</b>	<b>5</b>	<b>0.608</b>	<b>Moderate</b>
<b>Security</b>	<b>5</b>	<b>0.551</b>	<b>Poor</b>

## **Pearson Correlation**

One of the key techniques for establishing a relationship between the variables was Pearson's correlation study. The goal of this research was to look at the data to see if there was any correlation between the dependent variable, which was the factor influencing young tourists in Kelantan's intention to utilise smart tourism technology, and the independent variables, which were informativeness, security, and accessibility. If the correlation is substantial, researchers must decide if the strength of the association is appropriate. The following information illustrates the general guideline for interpreting a correlation coefficient's size in order to support that assertion.

Table 7 : Summary of Pearson Correlation results

Hypothesis	Pearson's correlation results	
<b>H1: There is a significant relationship between accessibility and intention to use smart tourism technology</b>	<b>r = 0.644, p &lt; 0.01</b>	<b>Moderate</b>
<b>H2: There is a significant relationship between informativeness and Intention to use smart tourism technology</b>	<b>r = 0.608, p &lt; 0.01</b>	<b>Moderate</b>
<b>H3: There is a significant relationship between security and Intention to use smart tourism technology</b>	<b>r = 0.551, p &lt; 0.01</b>	<b>Low</b>

## DISCUSSION AND RECOMMENDATION

The accessibility variable had the highest mean value in Descriptive Analysis for the independent variables, 4.1963, then the security variable, 4.0175. The independent variable with the lowest mean value was informativeness (3.8571). The dependent variable's mean value was 4.1668. It is possible to conclude that accessibility has an impact on the intention to use smart tourism technology among young tourists in Kelantan, as well as satisfaction while traveling among UMK students.

This study advises that more research be done on foreign tourists because the study focused on young tourists in Kelantan to see whether there are any parallels in the findings. If this study is



applied to international tourists in Kelantan, the findings may alter. As a result, instead of focusing just on local visitors, other foreigners were asked to complete the questionnaire. Furthermore, the study focuses on the variables that influence young tourists' intentions to use smart tourism technology in Kelantan. However, this study may have overlooked other major elements that impact the factor among young tourists in Kelantan. As a result, future researchers suggested that other variables, such as economic characteristics, be included in their research to include new discoveries. There are only 217 samples in this survey. The number will be sufficient and suitable, according to Krejcie and Morgan (1970), and a bigger sample size may be employed to organize the millions of Malaysian domestic visitors.

## **CONCLUSION**

This study's final objective was to look at the factors that affect young visitors' intentions to use smart tourism technology in Kelantan. Accessibility, informativeness and security are the independent variables that have an effect on the dependent variable among young visitors in Kelantan. The researchers take a quantitative strategy to gather all the data and information. The findings from the questionnaire survey were evaluated using a variety of techniques, including descriptive analysis, reliability analysis, and correlation analysis. The findings of the preceding chapter and all of the questionnaire data were examined using the Statistical Package for the Social Sciences (SPSS) 25 software. Additionally, this study provides recommendations and limits that may be helpful for future studies.

## REFERENCES

- Adnan, A. H. M., Shak, M. S. Y., Karim, R. A., Tahir, M. H. M., & Shah, D. S. M. (2020). 360-degree videos, VR experiences and the application of Education 4.0 technologies in Malaysia for exposure and immersion. *Adv. Sci. Technol. Eng. Syst. Journal*, 5(1), 373-381.
- Akter, M., Sadekin, M. N., & Patwary, A. K. (2020). An Empirical Study on Students' Satisfaction from Mawlana Bhashani Science & Technology University, Bangladesh. *Review of Economics and Development Studies*, 6(2), 363-379.
- Al Mahmud, S. R. (2020). The effectiveness of Facebook advertisements on purchase intention of customers in Malaysia. *South Asian Journal of Social Sciences and Humanities*, 1(1), 97-104.
- Alom, S., Patwary, A. K., & Khan, M. M. H. (2019). Factors affecting the turnover intention of Bangladeshi migrants in the United Arab Emirates: An empirical study on the hotel industry. *International Journal of Innovation, Creativity and Change*, 8(3), 344-360.
- Azis, N., Amin, M., Chan, S., & Aprilia, C. (2020). How smart tourism technologies affect tourist destination loyalty. *Journal of Hospitality and Tourism Technology*.
- Babu, S., & Subramoniam, S. (2016). Tourism Management in Internet of Things Era. *Journal of Information Technology & Economic Development*, 7(1).
- Bano, N., & Siddiqui, S. (2022). Consumers' intention towards the use of smart technologies in tourism and hospitality (T&H) industry: a deeper insight into the integration of TAM, TPB and trust. *Journal of Hospitality and Tourism Insights*, (ahead-of-print).
- Buhalis, D., & Michopoulou, E. (2011). Information-enabled tourism destination marketing: addressing the accessibility market. *Current Issues in Tourism*, 14(2), 145-168. <https://doi.org/10.1080/13683501003653361>
- Car, T., Stifanich, L. P., & Šimunić, M. (2019). Internet of things (iot) in tourism and hospitality: Opportunities and challenges. *Tourism in South East Europe*, 5, 163-175.
- Chan, F. M. (2002, October). ICT in Malaysian schools: Policy and strategies. In *a Workshop on the Promotion of ICT in Education to Narrow the Digital Divide* (pp. 15-22).
- Elfil, M., & Negida, A. (2017). Sampling methods in clinical research; an educational review. *Emergency (Tehran, Iran)*, 5(1). ncbi. <https://www.ncbi.nlm.nih.gov/pmc/articles/PMC5325924/>
- Femenia-Serra, F., Ioannou, A., & Tussyadiah, I. P. (2022). Is smart scary? A mixed-methods study on privacy in smart tourism. *Current Issues in Tourism*, 25(14), 2212-2238.
- Fengmin, Z., Baijun, W., Jiangtao, B., Li, L., & Patwary, A. K. (2022). Investigating revisit intention of medical tourists in China through nutritional knowledge, perceived medical quality, and trust in the physiologist: A recommendation on health tourism policy measures. *Frontiers in Public Health*, 10, 893497.
- Gajdošík, T. (2018). Smart tourism: Concepts and insights from Central Europe. *Czech Journal of Tourism*, 7(1), 25-44.

- Gong, Y., & Schroeder, A. (2022). A systematic literature review of data privacy and security research on smart tourism. *Tourism Management Perspectives*, 44, 101019.
- Goo, J., Huang, C. D., Yoo, C. W., & Koo, C. (2022). Smart Tourism Technologies' Ambidexterity: Balancing Tourist's Worries and Novelty Seeking for Travel Satisfaction. *Information Systems Frontiers*, 1-20.
- Hamzah, M. I., Ismail, A., & Embi, M. A. (2009). The impact of technology change in Malaysian smart schools on Islamic education teachers and students. *International Journal of Human and Social Sciences*, 4(11), 824-836.
- Hazbar, A. M. H., Alem Mohammed, A., & Karim, A. K. A. (2019). An Empirical Study of Factors Influencing hotel customers' online booking Intention. *مجلة العلوم التربوية و الدراسات الإنسانية*, (5), 1-17.
- Hinkle, Wiersma, & Jurs (2003). *Applied Statistics for the Behavioral Sciences* (5 th ed.). <https://oak.ucc.nau.edu/rh232/courses/EPS525/Handouts/Correlation%20Coefficient%20Handout%20-%20Hinkle%20et%20al.pdf>
- Huang, C. D., Goo, J., Nam, K., & Yoo, C. W. (2017). Smart tourism technologies in travel planning: The role of exploration and exploitation. *Information & Management*, 54(6), 757-770.
- Jeong, M., & Shin, H. H. (2020). Tourists' experiences with smart tourism technology at smart destinations and their behavior intentions. *Journal of Travel Research*, 59(8), 1464-1477.
- Kaur. (2018). *Descriptive statistics*. [www.ijam-Web.org](http://www.ijam-Web.org). <https://www.ijam-web.org/text.asp?2018/4/1/60/230853>
- Lee, P., Hunter, W. C., & Chung, N. (2020). Smart tourism city: Developments and transformations. *Sustainability*, 12 (10), 3958.
- Li, L., Ragavan, N. A., Patwary, A. K., & Baijun, W. (2022). Measuring patients' satisfaction toward health tourism in Malaysia through hospital environment, nutritional advice, and perceived value: A study on Chinese exchange students. *Frontiers in public health*, 10, 893439.
- Li, L., Wu, B., & Patwary, A. K. (2022). How marine tourism promote financial development in sustainable economy: new evidences from South Asia and implications to future tourism students. *Environmental Science and Pollution Research*, 29, 1155-1172.
- Li, L., Wu, B., & Patwary, A. K. (2022). The psychosocial factors affecting chinese Outbound Exchange and mobility students' academic performance during COVID-19. *Frontiers in psychology*, 13, 872516.
- Meyer, D. F. (2019). The Tourism Sector in Malaysia: An Analysis of the Impact of Economic Growth, Political Instability and the Exchange Rate. *International Journal of Innovation, Creativity and Change*, 5(2), 658-678.
- Morse, J. M. (2010). Simultaneous and Sequential Qualitative Mixed Method Designs. *Qualitative Inquiry*, 16(6), 483-491. <https://doi.org/10.1177/1077800410364741>
- No, E., & Kim, J. K. (2015). Comparing the attributes of online tourism information sources. *Computers in human behavior*, 50, 564-575.
- Omar A. (2014). Sample size estimation and sampling techniques for selecting a representative sample. *Journal of Health Specialties*, 2(4), 142-147.

- Opute, A. P., Irene, B. O., & Iwu, C. G. (2020). Tourism service and digital technologies: A value creation perspective. *African Journal of Hospitality, Tourism and Leisure*.
- Pai, C. K., Liu, Y., Kang, S., & Dai, A. (2020). The role of perceived smart tourism technology experience for tourist satisfaction, happiness and revisit intention. *Sustainability*, 12(16), 6592.
- Paraskevas, A. (2022). Cybersecurity in travel and tourism: a risk-based approach. In *Handbook of e-Tourism* (pp. 1605-1628). Cham: Springer International Publishing.
- Park, S. (2021). Big data in smart tourism: a perspective article. *Journal of Smart Tourism*, 1(3), 3-5.
- Patton, M. Q. (2002). *Qualitative Research and Evaluation Methods* (3rd ed.). Sage Publications.
- Patwary, A. K., Roy, B., Hoque, R., & Khandakar, M. S. A. (2019). Process of developing a community based tourism and identifying its economic and social impacts: An Empirical study on Cox's Bazar, Bangladesh. *Pakistan Journal of Humanities and Social Sciences*, 7(1), 1-13.
- Pradhan, M. K., Oh, J., & Lee, H. (2018). Understanding travelers' behavior for sustainable smart tourism: A technology readiness perspective. *Sustainability*, 10(11), 4259.
- Rafdinal, W., Susanto, E., Novianti, S., & Juniarti, C. (2021). Is smart tourism technology important in predicting visiting tourism destination? Lessons from West Java, Indonesia. *Journal of Tourism Sustainability*, 1(2), 102-115.
- Rantala, O., Rokenes, A., & Valkonen, J. (2018). Is adventure tourism a coherent concept? A review of research approaches on adventure tourism. *Annals of Leisure Research*, 21(5), 539-552.
- Scheyvens, R. (1999). Ecotourism and the empowerment of local communities. *Tourism management*, 20(2), 245-249.
- Seltman, H.,J. (2013). *Experimental Design and Analysis*. Pittsburgh, PA: Carnegie Mellon University, Variable classification
- Shorten A., Moorley C. (2014). Selecting the sample. *Evidence Based Nursing*, 17(2), 32–33.
- Sumethokula, P., Patwary, A. K., Srinuanpanc, B., Srinuanpand, C., Suwandee, P., Thammathikul, A., & Phanong, W. (2020). The potential of new tour repackaging for creative tourism among entrepreneurs in Nakhon Si Thammarat. *International Journal of Innovation, Creativity and Change*, 13(10), 1752-1771.
- Susanto, E., Novianti, S., Rafdinal, W., Prawira, M. F. A., & Septyandi, C. B. (2020). Visiting Tourism Destination: Is It Influenced by Smart Tourism Technology? *Journal of Indonesian Tourism and Development Studies*, 8(3), 145-155.
- Tyrer S., Heyman B. (2016). Sampling in epidemiological research: Issues, hazards and pitfalls. *British Journal of Psychiatry Bulletin*, 40, 57–60.
- Wu, B., Liu, S., Wang, J., Tahir, S., & Patwary, A. K. (2021). Assessing the mechanism of energy efficiency and energy poverty alleviation based on environmental regulation policy measures. *Environmental Science and Pollution Research*, 28, 40858-40870.

- Wu, B., Zhai, B., Mu, H., Peng, X., Wang, C., & Patwary, A. K. (2021). Evaluating an economic application of renewable generated hydrogen: A way forward for green economic performance and policy measures. *Environmental Science and Pollution Research*, 1-15.
- Zain, M., Rose, R. C., Abdullah, I., & Masrom, M. (2005). The relationship between information technology acceptance and organizational agility in Malaysia. *Information & management*, 42(6), 829-839.
- Zhang, Y., Sotiriadis, M., & Shen, S. (2022). Investigating the Impact of Smart Tourism Technologies on Tourists' Experiences. *Sustainability*, 14(5), 3048

# **Factor That Builds Youth's Intention To Do Adventure Tourism In Kelantan**

**Muhammad Ariff Syakirl Bin Hairol, Muhammad Ashrof Ridhuan Bin Mazemi, Muhammad Azam Ezaidi Bin Marzuki, Muhammad Fairul Daniel Bin Izhar & Siti Salina Binti Saidin\***

*Faculty of Hospitality, Tourism and Wellness, Universiti Malaysia Kelantan*

*Corresponding email: [salina.s@umk.edu.my](mailto:salina.s@umk.edu.my)*

---

## **ABSTRACT**

Adventure tourism is the migration of individuals from one place to another outside their comfort zone for exploration or travel to remote, exotic, and sometimes violent regions. Regardless of the poor economic circumstances that may be leading more young people to abandon adventure tourism. Since most of them are studying and some of it still new at work, they don't plan to spend their money on adventure tourism because there are more focused on saving money for their future, like buying a house, or car, or getting married and many more. This study aims to examine the relationship between place attraction, facilities and environmental education on youth's intention to do adventure tourism in Kelantan. To ensure the intention is guaranteed, a research method is conducted quantitatively. A total of 161 respondents participated to answer all question in this survey. Facilities received the highest mean score of 4.410 in data analysis and finding, indicating that this is the most important factor.

**Keywords: Adventure Tourism, Place Attraction, Facilities, Environmental Education, Youth's Intention**

---

## **INTRODUCTION**

This study focused on the factors that build youth's attention to do adventure tourism activities in Kelantan. The first chapter comprises the study's context, problem statement, research aims and questions, scope of investigation, significance of study (including practical and theoretical contribution), definition of words, and a summary of the entire chapter one.

## **SIGNIFICANCE OF THE STUDY**

### ***Adventure Tourism***

Adventure tourism, as defined by the Adventure Travel Trade Association (ATTA), refers to a type of vacation that incorporates physical activity, engagement with the natural environment, and cultural immersion. In contrast to previous definitions and debates, which focused on the notion of risk, the discussion on the importance of risk has been deemed unproductive. Although risk has been a

prominent aspect in earlier literature reviews, the argument regarding its role in adventure tourism experiences continues. In his work, Buckley (2012) suggests a conceptual approach that considers the concept of 'rush' to analytically demonstrate that while danger holds significance, it is not the primary factor in adventure tourism experiences.

## **LITERATURE REVIEW**

### **Place Attraction**

Place attractions play a crucial role in tourism as they serve as the driving factors that attract visitors. These attractions encompass a wide range of natural and cultural locations, historical sites, monuments, zoos, game reserves, aquaria, museums, art galleries, gardens, architectural landmarks, theme parks, sports facilities, festivals, events, wildlife, and people. According to Lew (2000), any element that is labeled and promoted as an attraction within a tourism system becomes one. There are three main types of place attractions: natural, man-made, and special events. Natural attractions are inherent features of a location that occur naturally and can be found worldwide (Boniface et al., 2020). On the other hand, man-made attractions are specifically designed for tourism purposes, either originally or repurposed from their original function (Camilleri, 2018). Purpose-built place attractions are designed explicitly with tourism in mind. Sports activities are highly popular tourist attractions, and they can be classified into three types: spectating, participation, and stadium tours. Special events come in various forms and sizes, offering limitless possibilities for creating unique experiences. Examples of special events include markets, festivals, parades, exhibits, and entertainment venues. For instance, an entertainment establishment that tourists enjoy visiting can be considered a special event (Pearce & Wu, 2018). These events can vary in size, ranging from large to small, and they can be permanent or temporary structures. Some entertainment venues may serve multiple purposes or have been repurposed for their current tourism-related function.

### **Facilities**

Tourism is created when the service element is combined with one of the other three factors: attraction, housing, or transportation (Provotorina et al., 2020).). As a result, one of the fundamental components of tourism is facilities, including pull factors. In other terms, it is the spirit or core of tourism. Travelling by bus or train, for example, is not tourism. It includes the services of reservation, booking, ticketing, and information provision. Facilities are all of the services and facilities that are required to make guests feel at ease when travelling. These include lodging, various forms of entertainment,

picnic spots, leisure, information and communication, and sightseeing possibilities. They encompass a wide array of facilities, such as arts, music, dance, restaurants, bars, shopping outlets, sports facilities, swimming areas, relaxation spots, food options, healthcare services, and communication resources. These amenities contribute to the overall experience of travelers and facilitate their enjoyment during their journeys.

### **Environmental Education**

Environmental Education (EE) is a transformative process that enables individuals to develop an awareness of their surroundings and acquire knowledge, skills, values, experiences, and the motivation to address current and future environmental issues (Hadjichambis & Paraskeva, 2020). It aims to foster attitudes, motivations, and commitments that lead to informed decision-making and responsible action-taking. This is achieved by enhancing people's understanding and awareness of the environment and its challenges, cultivating the necessary skills and expertise to tackle these challenges, and promoting attitudes, motivations, and commitments to take proactive measures. The goal of EE is to cultivate informed citizens who possess knowledge about the biophysical environment and its associated challenges. They are equipped with the capacity to contribute to the resolution of these problems and are motivated to work towards their mitigation. EE should provide a holistic, lifelong education that is responsive to the ever-changing world, providing an understanding of the critical issues facing the modern world. It also equips individuals with the necessary skills and qualities to make positive contributions to enhancing quality of life and safeguarding the environment, while upholding ethical principles.

### **Intention To Do Adventure Tourism**

The intention is a good substitute for motivation-related factors, as it is a plan or motivation to act. According to Tapar, Dhaigude, & Jawed (2017) The likelihood of improved performance is determined by the degree of intent for a specific behaviour. It is a mental state where a person has chosen a course of action when they have an intention, and those that are successful carry through the planned course of action, while those that are failed do not. According to Sherran & Webb (2016) Intentions are what people tell themselves to do to get the desired results. Intentions are what people tell themselves to do in order to get the results they want, and interventions that support public health,



energy conservation, educational goals, and organisational outcomes typically rely on frameworks that view intentions as a key determinant of behaviour change.

### Research Hypothesis

The hypothesis of this reserach is to find out whether there are any correlations or relationships between dependent variables and independent variables:

- H<sub>1</sub>** There is a significant relationship between place attraction and youth's intention to do adventure tourism activities in Kelantan.
- H<sub>2</sub>** There is a significant relationship between facilities and youth's intention to do adventure tourism activities in Kelantan.
- H<sub>3</sub>** There is a significant relationship between environmental education and yout's intention to do adventure tourism activities in Kelantan.

### Research Framework

Figure 1 below shows the research framework used for this study.

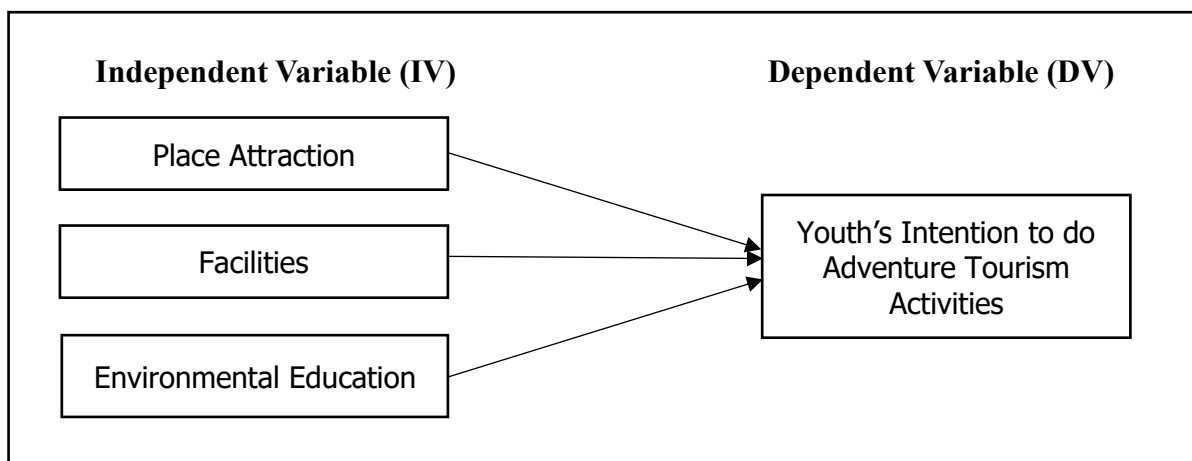

Figure 1: Research Framework

## METHODOLOGY

### Research Design

The development of the research design refers to the general strategy that the researcher selected to combine the study's various aspects in a logical and reasonable point. Descriptive analysis has been chosen to determine the components that contribute to the factors that build the youth's intention to do adventure tourism activities in Kelantan. It is also referred to as quantitative analysis, which

describes phenomena as they occur. This form of research describes social circumstances, social arrangements, social environments, etc. The observer follows and identifies what he/she discovered. The descriptive analysis intent on rendering the characteristics of a specific group or scenario closely may carry out a narrative review about the works in a company, their age circulation, their society-wise allocation, their educative status, and so on.

### **Data Collection**

Data collection involves systematically gathering and analyzing relevant information on specific variables to address research questions, test hypotheses, and evaluate findings. In this particular study, data was collected through a survey that utilized questionnaires. Questionnaires serve as a tool for collecting data by posing a series of questions to respondents. The use of questionnaires in this study offers several advantages. Firstly, it is a standardized method, making it less expensive and easier to manage compared to alternative data collection methods. Additionally, due to the large number of participants in this study, questionnaires provide an efficient means of gathering data and information. Each survey will be accompanied by a cover letter that explains the research purpose to the respondents, ensuring they understand the motivation and goals of the study. The questionnaire consists of four sections that participants will need to complete by selecting appropriate answers. The responses provided by the participants will serve as the data collected for the research. The questionnaires are being distributed among the youth population in Kelantan.

### **Sampling**

In this study, non-probability convenience sampling was utilized. Non-probability sampling, despite its limitations, can be valuable, particularly when dealing with large populations (Etikan et al., 2016). Convenience sampling is a straightforward and cost-effective method, as it involves selecting respondents who are readily available and accessible. Since the respondents play a key role in providing data, questionnaire results can be utilized for research purposes (Dudovskiy, 2018). This approach allows researchers to gather data from participants who are willing to participate, which can enhance the overall data collection process. In this particular study, the questionnaire will be distributed exclusively to young individuals throughout the state of Kelantan..

## Data Analysis

This process involves reviewing, clarifying, and organizing the collected data. Before proceeding with data analysis, researchers should have a clear understanding of the purpose and rationale behind the study. The analysis includes descriptive data analysis, reliability analysis, and Pearson correlation. These statistical procedures are conducted using the Social Science Statistical Package Version 24 (SPSS), specifically IBM SPSS version 24. SPSS is a comprehensive software tool designed for processing statistical data and generating various outputs to address the research objectives.

## FINDINGS

### Profile of Respondents

Table 1: Respondent's Profile

<b>Demographic</b>	<b>Category</b>	<b>Frequency (N)</b>	<b>Percentage (%)</b>
<b>Gender</b>	Female	107	66.5
	Male	54	33.5
<b>Age</b>	15-20 years old	5	3.1
	21-25 years old	143	88.8
	26-30 years old	5	3.1
	31-35 years old	7	4.3
	36-40 years old	1	0.6
<b>Race</b>	Malay	150	93.2
	Chinese	4	2.5
	Indian	4	2.5
	Others	3	1.8
<b>Marital Status</b>	Single	148	91.9
	Married	13	8.1
<b>Occupation</b>	Governments staff	4	2.5
	Private sector	6	3.7
	Self- employed	4	2.5
	Student	142	88.2
	Unemployed	5	3.1

Table 1 presents the profiles of the 161 respondents in the study. The majority of the respondents are female, accounting for 66.5% of the total sample, while males represent 33.5%. Regarding age, the largest proportion of respondents falls within the 21-25 years old category, comprising 88.8% of the sample. The lowest frequency of respondents is found in the 36-40 years old category, with only 0.6%. In terms of ethnicity, the majority of the respondents are Malay, accounting for 93.2% of the sample. Other ethnicities have the lowest frequency, representing 1.8% of the total. As for marital status, the majority of respondents are single, making up 91.9% of the sample, while married respondents constitute only 8.1%. In relation to occupation, the largest proportion of respondents (88.2%) consists of students, indicating that they form the majority within the total sample. The lowest frequency of respondents (2.5%) is observed in the categories of government staff and self-employed. These demographic findings accurately reflect the actual compilation of factors that contribute to the intentions of young individuals to engage in adventure tourism activities in Kelantan.

### **Analysis for Factor That Builds Youth's Intention to do Adventure Tourism Activities in Kelantan.**

Table 2: Descriptive Analysis for factor that build youth's intention to do adventure tourism activities in Kelantan.

<b>Variable</b>	<b>Items</b>	<b>N</b>	<b>Mean</b>	<b>Standard Deviation</b>
<b>Youth's Intention to do Adventure Tourism Activities</b>	I think adventure tourism can relieve stress and tension.	161	4.57	0.677
	I think to develop physical fitness.	161	4.32	0.762
	I think to discover new things.	161	4.40	0.674
	I intend to improve skill and ability in doing them.	161	4.30	0.749
	I want to satisfy my curiosity.	161	4.40	0.683
<b>Place Attraction</b>	Place attraction gained my attention to involved in adventure tourism	161	4.40	0.753
	I tend to participate in adventure tourism because of man-made attraction	161	4.07	0.877
	I tend to participate in adventure tourism because of neutral attraction	161	4.43	0.748
	I will consider place attraction more than other aspect to join adventure tourism	161	4.17	0.760

	Beautiful scenery can release my stress	161	4.60	0.635
<b>Facilities</b>	The facilities provided at the location attract me to join adventure tourism.	161	4.40	0.636
	Secure facilities that guarantee safety encourage me to join adventure tourism.	161	4.50	0.643
	Accommodation at the place motivate me to join adventure tourism.	161	4.35	0.702
	Secure equipment that provided attract me to join adventure tourism.	161	4.40	0.702
	Safety and emergency measures provided motivate me to join adventure tourism.	161	4.39	0.760
<b>Environmental Education</b>	The desire to experience the landscape and moods of nature motivate me to join adventure tourism.	161	4.35	0.692
	Desire to appreciate beautiful natural resources encourages me to join adventure tourism.	161	4.37	0.641
	The need to have a time for natural study motivates me to participate in adventure tourism.	161	4.27	0.740
	Desire to enjoy flora and fauna attract me to join adventure tourism.	161	4.40	0.693
	The need to find peace and quiet motivate me to join adventure tourism.	161	4.47	0.759

Table 2 presents the mean and standard deviation of the dependent and independent variables in this study. The dependent variable with the highest mean value is Question 1, scoring 4.57 (SD = 0.677), indicating that respondents agree that adventure tourism can alleviate stress and tension. On the other hand, Question 4 has the lowest mean value of 4.30 (SD = 0.749), suggesting that some respondents do not have the intention to enhance their skills and abilities. Regarding the independent variable of place attraction, Question 4 obtained the highest mean value of 4.60 (SD = 0.635), indicating that respondents agree that beautiful scenery can help alleviate stress. Conversely, Question 2 has the lowest mean value of 4.07 (SD = 0.877), indicating that respondents tend to participate in adventure tourism because of man-made attractions. For the independent variable of facilities factor, Question 2 obtained the highest mean value of 4.50 (SD = 0.643), suggesting that respondents believe secure facilities that ensure safety encourage them to engage in adventure tourism. Question 3 has the lowest

mean value of 4.35 (SD = 0.702), indicating that respondents agree that accommodation at the destination motivates them to participate in adventure tourism. In terms of the independent variable of environmental education, Question 5 has the highest mean value of 4.47 (SD = 0.759), suggesting that respondents agree that they need to find peace as a motivation to engage in adventure tourism. Question 3 has the lowest mean score of 4.27 (SD = 0.740), indicating that respondents agree that having time for nature study motivates them to participate in adventure tourism.

### Reliability Analysis Coefficient Alpha for the Independent Variables and Dependent Variable

Table 3: Result of Reliability Coefficient Alpha for the Independent Variables and Dependent Variable

Variable	Number of Item	Cronbach's Alpha coefficient	Strength of Association
Youth's Intention	5	0.863	Very Good
Place Attraction	5	0.811	Very Good
Facilities	5	0.877	Very Good
Environmental Education	5	0.897	Very Good
Overall Variables	20	0.943	Excellent

Table 3 presents the Cronbach's Alpha coefficients for the independent and dependent variables in this study. The values for all variables exceeded 0.8, with an aggregate coefficient of 0.943, indicating high reliability and supporting the acceptance of the results. The measurement of youth's intention to do adventure tourism in Kelantan utilized five questions, and the Cronbach's Alpha coefficient for this section was 0.863, indicating very good. Similarly, the place attraction variable, assessed with five questions, yielded a Cronbach's Alpha coefficient of 0.811, also indicating very good reliability. The facilities variable, consisting of five questions, achieved a Cronbach's Alpha coefficient of 0.877, signifying very good reliability. Lastly, the environmental education variable, measured with five questions, obtained a Cronbach's Alpha coefficient of 0.897, also indicating very

good reliability. The Cronbach's Alpha coefficients exceeding 0.9 for all variables demonstrate that the questionnaires used in this study are excellent reliable. This suggests that the respondents understood the questions well, further supporting the suitability of the questionnaires for this study.

### **Relationship between Place Attraction, Facilities, Environmental education towards Youth's Intention to do Adventure tourism Activities in Kelantan.**

Table 4: Pearson's Correlation between place attraction, facilities, environmental education towards youth's intention to do adventure tourism activities in Kelantan.

		<b>Youth's Intention to do Adventure tourism Activities in Kelantan.</b>
<b>Place Attraction</b>	Pearson correlation	0.548
	Sig. (2-tailed)	<.001
	N	161
<b>Facilities</b>	Pearson correlation	0.513
	Sig. (2-tailed)	<.001
	N	161
<b>Environmental Education</b>	Pearson correlation	0.555
	Sig. (2-tailed)	<.001
	N	161

The result in Table 4 indicates place attraction and youth's intention to do adventure tourism activities in Kelantan. 0.548 indicated a moderately strong positive correlation. Next are facilities and the youth's intention to do adventure tourism activities in Kelantan. 0.513 indicating a moderate positive correlation. Followed by environmental education and youth's intention to do adventure tourism activities in Kelantan with 0.555 indicated a strong positive correlation. Therefore, all three variables positively correlated with the youth's intention to do adventure tourism activities in Kelantan and the relationship is significant.

According to Lou (2014), the more interesting the place offers, the more people intend to do adventure tourism.

**H1:** There is a significant relationship between place attraction and youth's intention to do adventure tourism activities in Kelantan

Mahazir (2021) states that facilities are important to people before joining adventure tourism accommodation, secure equipment, especially safety and emergency provided at that place.

**H2:** There is a significant relationship between facilities and youth's intention to do adventure tourism activities in Kelantan

Environmental education is environmental awareness and knowledge. According to Mason (2016) stated environmental education is refer to people who participate the adventure tourism for natural study and enjoy the flora and fauna, and appreciate the beautiful natural study.

**H3:** There is a significant relationship between environmental education and youth's intention to do adventure tourism activities in Kelantan

## **DISCUSSION AND RECOMMENDATION**

More research should be done to make the results more believable by balancing travel partners can be relatives and friends, friends and acquaintances, or even organisational packages. This is due to the fact that various people who participate in adventure activities may have opposing perspectives. Furthermore, the current study primarily focuses on three characteristic that build youth's intentions to do adventure tourism activities in Kelantan. However, this study may overlook other critical elements that build youth's intentions to do adventure tourism activities in Kelantan. As a result, future researchers might suggest additional variables, such as economic factors, to carry out new results in their study. This research uses qualitative approaches for this goal. Nonetheless, we all agree that future researchers should send out the Google form link as soon as possible. So that future researchers can collect a large number of responders in a short period of time. Furthermore, a future researcher can repeatedly click on the link. Researchers, for example, can distribute links using social media platforms such as WhatsApp and Telegram..

## **CONCLUSION**

In conclusion, this study evaluated the factors that build youth's intentions to do adventure tourism activities in Kelantan. This study investigates the interaction between place attraction, facilities, and environmental education in youth's intentions to do adventure tourism activities in Kelantan. As mentioned in Chapter 3, researchers used a Google Form to distribute questionnaires to 161



respondents, asking them about the variables that influence their decision to participate in adventure tourism activities. These people were requested to fill out questionnaires. In addition, the researcher employs a quantitative technique to acquire all facts and information. The researcher employed Google Forms as the survey tool to reach respondents across Kelantan. This choice was made for its convenience, allowing respondents to easily complete the surveys and saving time and resources for the researcher. The questionnaire survey findings were analyzed using various techniques, including frequency analysis, descriptive analysis, reliability analysis, and correlation analysis. All data collected from the questionnaire, along with the results from the previous chapter, were examined using the statistical software SPSS 24 (Statistical Package for the Social Science). SPSS 24 was selected by the researchers due to its user-friendly interface and ability to generate comprehensive results. Furthermore, this study acknowledges its limitations and provides suggestions that could prove valuable for future research endeavors.

## REFERENCES

- Akter, M., Sadekin, M. N., & Patwary, A. K. (2020). An Empirical Study on Students' Satisfaction from Mawlana Bhashani Science & Technology University, Bangladesh. *Review of Economics and Development Studies*, 6(2), 363-379.
- Alom, S., Patwary, A. K., & Khan, M. M. H. (2019). Factors affecting the turnover intention of Bangladeshi migrants in the United Arab Emirates: An empirical study on the hotel industry. *International Journal of Innovation, Creativity and Change*, 8(3), 344-360.
- ATI (Aviation and Tourism International) (1995) Europe's Youth Travel Market. Brussels: European Travel Commission (written by S. Wheatcroft and J. Seekings).
- Buckley, R. 2012. "Rush as a Key Motivation in Skilled Adventure Tourism: Resolving the Risk Recreation Paradox." *Tourism Management* 33: 961–970.
- Camilleri, M. A. (2018). The tourism industry: An overview. *Travel marketing, tourism economics and the airline product*, 3-27.
- Etikan, I., Alkassim, R., & Abubakar, S. (2016). Comparison of snowball sampling and sequential sampling technique. *Biometrics and Biostatistics International Journal*, 3(1), 55.
- Fengmin, Z., Baijun, W., Jiangtao, B., Li, L., & Patwary, A. K. (2022). Investigating revisit intention of medical tourists in China through nutritional knowledge, perceived medical quality, and trust in the physiologist: A recommendation on health tourism policy measures. *Frontiers in Public Health*, 10, 893497.
- Hadjichambis, A. C., & Paraskeva-Hadjichambi, D. (2020). Education for environmental citizenship: The pedagogical approach. *Conceptualising environmental citizenship for 21st century education*, 4, 237-261.
- Hazbar, A. M. H., Alem Mohammed, A., & Karim, A. K. A. (2019). An Empirical Study of Factors Influencing hotel customers' online booking Intention. *مجلة العلوم التربوية و الدراسات الإنسانية*, (5), 1-17.

- Jayaprakash, K., & Mythili, B. 2017. Tourist Satisfaction Level on Destination Facilities in The Nilgiris. *EPR International Journal of Economic and Business Review*, 5(9), 122-126.
- Li, L., Ragavan, N. A., Patwary, A. K., & Baijun, W. (2022). Measuring patients' satisfaction toward health tourism in Malaysia through hospital environment, nutritional advice, and perceived value: A study on Chinese exchange students. *Frontiers in public health*, 10, 893439.
- Li, L., Wu, B., & Patwary, A. K. (2022). How marine tourism promote financial development in sustainable economy: new evidences from South Asia and implications to future tourism students. *Environmental Science and Pollution Research*, 29, 1155-1172.
- Li, L., Wu, B., & Patwary, A. K. (2022). The psychosocial factors affecting chinese Outbound Exchange and mobility students' academic performance during COVID-19. *Frontiers in psychology*, 13, 872516.
- Lou, J. (2014). Analysis of adventure tourist motivation: The case of China-born international students in New Zealand universities (Doctoral dissertation, Auckland University of Technology).
- Ly, A., Marsman, M., & Wagenmakers, E. J. (2018). Analytic posteriors for Pearson's correlation coefficient. *Statistica Neerlandica*, 72(1), 4-13.
- Mahazir, M., Hasim, N. A. C., Ali, N. M., Jaafar, S. N. A., & Kosnin, R. (2021). Motivation That Triggers Adventure Tourism Participation Among Youths in Malaysia.
- Mason, M. C., Gos, L., & Moretti, A. (2016). Motivations, perceived risk and behavioural intentions in hard adventure tourism. A natural park case study. *Sinergie Italian Journal of Management*, 34(May-Aug), 181-199.
- Patwary, A. K., Roy, B., Hoque, R., & Khandakar, M. S. A. (2019). Process of developing a community based tourism and identifying its economic and social impacts: An Empirical study on Cox's Bazar, Bangladesh. *Pakistan Journal of Humanities and Social Sciences*, 7(1), 1-13.
- Pearce, P. L., & Wu, M. Y. (2018). Entertaining international tourists: An empirical study of an iconic site in China. *Journal of Hospitality & Tourism Research*, 42(5), 772-792.
- Provotorina, V., Kazmina, L., Petrenko, A., & Ekinil, G. (2020). Organisation and functioning of accommodation facilities as a component of rural tourism infrastructure in the Rostov Region. In *E3S Web of conferences* (Vol. 175, p. 10002). EDP Sciences.
- Sheeran, P., & Webb, T. L. (2016). The intention–behavior gap. *Social and personality psychology compass*, 10(9), 503-518.
- Sumethokula, P., Patwary, A. K., Srinuanpanc, B., Srinuanpand, C., Suwandee, P., Thammathikul, A., & Phanong, W. (2020). The potential of new tour repackaging for creative tourism among entrepreneurs in Nakhon Si Thammarat. *International Journal of Innovation, Creativity and Change*, 13(10), 1752-1771.
- Tapar, A. V., Dhaigude, A. S., & Jawed, M. S. (2017). Customer experience-based satisfaction and behavioural intention in adventure tourism: exploring the mediating role of commitment. *Tourism Recreation Research*, 42(3), 344-355.
- Wu, B., Liu, S., Wang, J., Tahir, S., & Patwary, A. K. (2021). Assessing the mechanism of energy efficiency and energy poverty alleviation based on environmental regulation policy measures. *Environmental Science and Pollution Research*, 28, 40858-40870.
- Wu, B., Zhai, B., Mu, H., Peng, X., Wang, C., & Patwary, A. K. (2021). Evaluating an economic application of renewable generated hydrogen: A way forward for green economic performance and policy measures. *Environmental Science and Pollution Research*, 1-15.

# FACTORS INFLUENCING INTENTION TO USE SMART MOBILE APPS AMONG LOCAL TRAVELLER IN EAST COAST MALAYSIA

*Muhammad Faiz Akif Bin Fairus, Muhammad Faiz Fitri Bin Abdul Rahim, Muhammad Fakhri Bin Norazman, Muhammad Fakhruddin Bin Che Khalid & \*Dr Siti Salina Binti Saidin*

*Faculty of Hospitality, Tourism and Wellness, Universiti Malaysia Kelantan,*

*City Campus Pengkalan Chepa, Kota Bharu, Kelantan, Malaysia*

*Corresponding email: [salina.s@umk.edu.my](mailto:salina.s@umk.edu.my)*

## ABSTRACT

The current research aims to examine how social influence, performance expectations and price value influence the intention to use mobile applications among East Coast residents. This study focuses on the ease of use that leads to the intention to use smart mobile apps among consumers. Therefore, this research has used quantitative methods to achieve its objective. Researchers have examined 30 questions related to variables that have been established where all variables have a significant relationship with intention to use smart mobile apps among east coast residents using a "Google Form" or questionnaire. The results show that social influence, performance expectations and price value have a significant correlation between East Coast local travelers' intentions to use smart mobile applications. The findings obtained from this study will help smart mobile application developers in creating user-friendly applications, especially those on the east coast. In conclusion, all the data in this study can be used as a guideline for strategic planning in order to be able to use smart mobile applications on the east coast and especially in Malaysia.

**Keywords:** Intention to use smart mobile apps, social influence, performance expectancy, price value

## **INTRODUCTION**

Travelling for pleasure, social, or business is the travel and tourism industry. The travel industry is tourism. It is closely tied to the hotel, hospitality, and transportation businesses and mostly focuses on keeping guests happy, engaged, and supplied while they are away from home. Mobile applications (apps) have grown exponentially in the digital media business. Mobile app usage intentions from functional, contextual, and motivational communication perspectives have received little investigation despite its rapid growth and diffusion. Understanding app use intention variables can teach app developers, marketers, and academics how people choose apps. Recent studies examined the effects of various mobile communication devices. However, the studies solely examined voice calling usage.

## **SIGNIFICANCE OF THE STUDY**

This study looks into the variables affecting east coast residents' intentions to utilise smart mobile phone apps. This study can be used by developers of applications or mobile phone apps to improve their products and increase consumer happiness, particularly among east coast residents. We must utilise technology to make it simpler for tourists to survey and less likely that they would be taken advantage of by locals in order to strengthen Malaysia's economy. If they are informed enough to travel to Malaysia, they will promote it in their own nation. The study's findings can also be used to inform the tourism industry's efforts to develop innovative tactics for drawing in more domestic and international visitors.

## LITERATURE REVIEW

An essential component of the electronic payment system is the electronic wallet (sometimes known as a "e-wallet"). Customers must link their debit or credit cards to their electronic wallets before they may make any transactions. When using electronic cards to make certain payments, users can save the details of their physical cards and bank account information. It is said that using an e-wallet saves time and money compared to using a traditional banking system. Payments can be made through cellular-based payment methods as well as mobile apps. E-wallet users appreciate ease, speed, and security while making payments. The six most well-known and frequently used e-wallets in Malaysia among the more than 42 that Bank Negara Malaysia (BNM) has legally authorized are AEON Wallet, Boost, BigPay, GrabPay, WeChat pay, and Touch'n Go eWallet.

### **Social influence**

Venkatesh et al. (2012, p. 159) define social influence as "the extent to which consumers sense that significant persons (e.g., family and friends) believe they should use a specific technology." Interpersonal influence and media-related impact are the two main types of social influence, according to (Wei et al. 2009). While interpersonal influence often originates from social networks like classmates, friends, superiors, and so on, mass media influence encompasses publications like newspapers, scholarly journals, magazines, the internet, radio, and television (Park, et al. 2007). Furthermore, Lu et al. (2005) pointed out that social influence is only significant in situations where it is necessary. Chong (2013) found that System Integration is a significant driver of Business Intelligence in his study of m-commerce. Customers of mobile commerce are likely to take cues from their social networks, family, the media, and other mobile commerce users when making behavioural decisions. Chong et al. (2012) claim that social influence has a significant influence on consumers' intentions to use mobile commerce in Malaysia and China. Leong et al.'s (2013) 2013b study also validated the aforementioned conclusion. The aforementioned conclusion implies that in Chong's study on m-commerce, the integration of different systems (SI) significantly influences the effectiveness of business intelligence (BI). This suggests that a well-integrated system is crucial for collecting and analyzing data to make informed

business decisions in the mobile commerce domain.. Since they are available to all user groups and are required, mobile apps.

## **Performance Expectancy**

Performance expectation is the idea that using a certain technology or method will, in some way, benefit the user or improve their performance (Mahmood, 2021). The degree to which a person expects that using the system would enable him to benefit from his activities is known as performance expectancy (Venkatesh et al. 2003). Performance expectancy, on the other hand, states that a person will use an information system if the system may assist in improving its performance.

## **Price Value**

The majority of mobile applications are available for free download, but additional expenses such as Internet, mobile device, and device maintenance fees are associated with utilising them. Price value is defined as the cognitive trade-offs between the perceived benefits of the applications and the monetary cost of utilising them. According to Hanafizadeh et al. (2014), one of the factors that customers would take into account while deciding whether or not to use mobile banking services is the cost. Venkatesh et al. (2012) also concluded that a favourable pricing value could influence behavioural intention favourably. Price value follows the concept of perceived value, which compares and evaluates perceptions of relative rewards obtained and associated costs incurred. If the perceived benefits surpass the costs incurred for using IT applications, this may affect how people use technology.

## **Intention To Use Mobile Apps**

The tourism and hospitality industries are big fans of smart travel apps (Lai, 2015). Customers can use mobile devices to organise their vacations with the help of smart travel apps (Anshari and Alas, 2015). Travellers utilise mobile devices to book excursions, hotels, and flights in addition to seeing well-known attractions. By adopting travel applications in response to demand, tour operators have improved client interactions and produced more memorable experiences (Lu, 2015). Many studies have looked at how mobile technology affects travellers' enjoyment (Cai, 2019). The consumer experience can be enhanced through mobile apps in the tourism industry (Liebana-Cabanillas 2020). This study analyses the elements of e-service quality

that influence app usage by users. E-service quality is determined by social influence, performance expectation, and price value.

### **Research Hypotheses**

A hypothesis is a forecast or explanation of a link between two variables, suggesting the existence of a structured link between them. It must be testable and realistic, taking current knowledge and methodologies into account.

H1: There is relationship between social influence and Intention to use smart mobile travel apps among east coast resident.

H2: There is relationship between performance expectancy and Intention to use smart mobile travel apps among east coast resident.

H3: There is relationship between price value and Intention to use smart mobile travel apps among east coast residents



## Research Framework

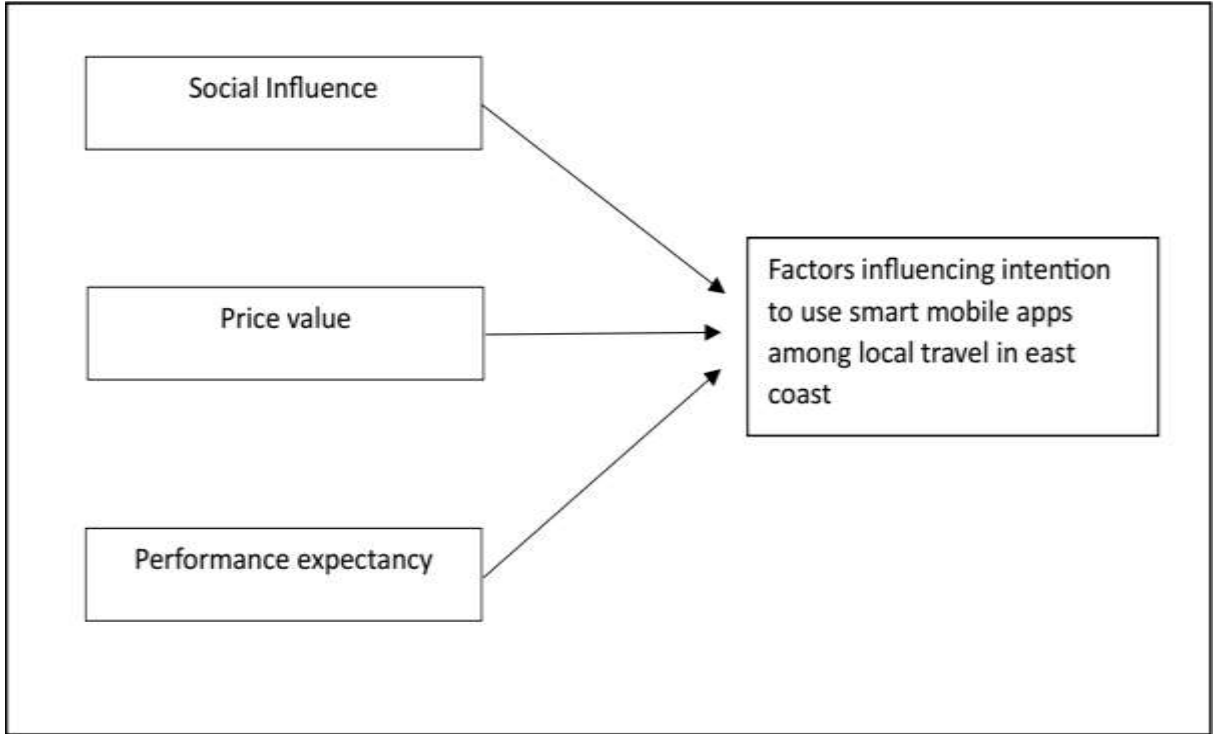

**Figure 1: Research Framework**

## **METHODOLOGY**

The procedures of the study, including the study design, target population, sample size, sampling technique, data collecting, research equipment design, and data analysis, are the main topics of this chapter. It offers a summary of each stage as well as the statistical methods applied to evaluate the hypotheses. The research methodologies will be explained in this chapter. The steps and statistical methods applied to evaluate the hypotheses will be outlined. The chapter will decide which method of data collection is most efficient.

### **Research Design**

A research design is a project plan for a study that specifies the steps researchers must take to test their hypotheses or reach their study objectives (McDaniel and Gates, 1999). Quantitative research is a quantifiable examination of numerical data obtained through broad inquiries using techniques like surveys and questionnaires. For the examination to have increasing factual power for hypotheses regarding the finds, an example size is necessary (Kumar, Talib, & Ramayah, 2013). The study's goal is to identify the variables that affect Malaysian local tourists' travel consumer behaviour. The right technique is to develop an expressive research plan after evaluating the situational, societal, and personal factors. The investigation had used a quantitative research strategy.

### **Data Collection**

The major tool for gathering data in this study was a questionnaire. Information obtained for the first time with the goal of resolving a problem is referred to as primary data. Surveys are significant data sources because they provide respondents a variety of questions and allow them to mark the ones that they feel are relevant. Every set of questionnaires will be accompanied with a cover letter outlining the purpose of the study for the respondent. The data we compile from the responses is what allows us to arrive at the study's conclusions. Locals received the questionnaires by postal mail.

## **Sampling**

A big population or a sample survey of variables is sampled as part of a statistical analysis (Poonam, 2022). There are two basic kinds of sampling techniques: probability sampling and non-probability sampling, depending on the sort of study being conducted. Non-probability sampling techniques will be applied in this investigation. Since convenience sampling is easy to use and moderately priced, it will be used in this study. To carry out this investigation, non-probability convenience sampling was employed. Despite these limitations, non-probability sampling is useful, according to Etikan et al. (2016). especially when there is a large population. Convenience sampling is very easy and affordable, because the respondents are readily available to finish the survey. Since the questionnaire is the primary source of data for the study, its results can be used (Dudovskiy, 2018). As a result, this approach can help researchers gather more data from participants who are convenient to reach.

## **Data Analysis**

Data analysis is a method of assessing information by carefully examining each item of the data while applying logical, scientific reasoning. It can be done in many ways, such as information mining, content analysis, business insight, and information perception. SPSS is used to analyse statistical data and provide different outputs to respond to objective studies.

## Findings

The findings showed that social influence, performance expectations, and price value are the most important behavioural intention antecedents. It was found that travellers' intents and habits for using technology (smart mobile apps) had an impact on their actual usage behaviour. The intention of tourists to utilise smart mobile apps while travelling was not significantly impacted by performance expectations, social influence, or price value, it was noted.

**Table 1: Descriptive Statistics**

	N	Minimum	Maximum	Mean	Std. Deviation
The use of smart mobile apps has influenced local travelers on the east coast to travel.	169	1	5	4.15	.974
Social influence has influenced local travelers on the east coast to travel.	169	1	5	4.29	.782
Performance expectancy has influenced local travelers on the east coast to travel.	169	1	5	4.19	.852
Price value has influenced local travelers on the east coast to travel.	168	1	5	4.23	.796
Valid N (listwise)	168				

The total number of respondents, the mean, and the standard deviation for the independent and dependent variables were displayed in Table 1. Social influence had the highest mean among the independent variables (4.29), followed by price value (4.23), and performance expectancy (4.19). The dependent variable's mean value was 4.15.

**Table 2: Reliability Analysis**

Variable	Cronbach's Alpha	No of Item	N
Factors Influencing Intention To Use Smart Mobile Apps Among Local Traveller In East Coast	0.874	4	169
Social Influence	0.828	4	169
Performance Expectancy	0.847	4	169
Price Value	0.845	3	169
All Variable	0.935		169

Reliability is the ability to judge a questionnaire's consistency and stability, which is essential for evaluating the importance and caliber of primary data. Researchers used measurements and tools developed by others with relevant interests.

**Table 4:** Correlation coefficient for social influence and factors influencing intention to use smart mobile apps among local traveller in east coast.

		IV1	DV
IV1	Pearson Correlation	1	.587**
	Sig. (2-tailed)		.000
	N	169	169
DV	Pearson Correlation	0.587**	1
	Sig. (2-tailed)	0.000	
	N	169	169

According to DeCoster & Claypool (2004), there is a continuous or linear relationship between the two constant variables. It will demonstrate that the data that was gathered will be related. The correlation lies in the range of -1.0 to 1.0. If it displays a positive mark, the range will expand and the other element will follow suit. The smaller the range, the lower the range will be for the other element if it displays a negative mark. If the range is zero, there is a relationship between the variables.

## **DISCUSSION AND RECOMMENDATION**

This study focuses on those living on the East Coast and recommends further investigation on foreign visitors to Malaysia. It might ignore additional aspects, such as economic concerns, that influence local passengers' intents to utilise smart mobile apps. Academics can advise employing interviews or open-ended questions rather than online questionnaires to enhance study outcomes. This strategy can reduce misconceptions and enhance study results.

## **CONCLUSION**

This study examines the impact of social influence, performance expectations, and price value on East Coast local travellers' intentions to utilise mobile apps with advanced features. 69 pieces of literature served as the foundation for a study framework. The online survey had 169 participants in total, and the reliability analysis showed a total variable of 0.935. According to the findings, social influence, performance expectations, and price value has a significant correlation between East Coast local travellers' intentions to utilise smart mobile apps.

## **REFERENCES**

- Abubakar, S., Etikan, I., & Alkassim, R. (2016). *Comparision of Snowball Sampling and Sequential Sampling Technique Comparision of Snowball Sampling and Sequential Sampling Technique*. <https://www.academia.edu/download/42569290/BBIJ-03-00055.pdf>
- Akter, M., Sadekin, M. N., & Patwary, A. K. (2020). An Empirical Study on Students' Satisfaction from Mawlana Bhashani Science & Technology University, Bangladesh. *Review of Economics and Development Studies*, 6(2), 363-379.
- Alalwan, A. A. (2020). Mobile food ordering apps: An empirical study of the factors affecting customere-satisfaction and continued intention to reuse. *International Journal of Information Management*, 50, 28-44.
- Alom, S., Patwary, A. K., & Khan, M. M. H. (2019). Factors affecting the turnover intention of Bangladeshi migrants in the United Arab Emirates: An empirical study on the hotel industry. *International Journal of Innovation, Creativity and Change*, 8(3), 344-360.

- Bonsu, S. (2019). Corporate Social Responsibility: Assessing the Alignment of Theory and Practice Utilizing Case Studies. *Journal of Marketing and Management*, 10(1), 1–18. <https://gsmi-ijgb.com/wp-content/uploads/JMM-V10-N1-P01-Samuel-Bonsu-Corporate-Social-Responsibility.pdf>
- Chong, A. Y.-L., Chan, F. T. S., & Ooi, K.-B. (2012). Predicting consumer decisions to adopt mobile commerce: Cross country empirical examination between China and Malaysia. *Decision Support Systems*, 53(1), 34–43. <https://doi.org/10.1016/j.dss.2011.12.001>
- Cui, Y., Mou, J., Cohen, J., Liu, Y., & Kurcz, K. (2019). Understanding consumer intentions toward cross-border m-commerce usage: a psychological distance and commitment-trust perspective. *Electronic Commerce Research and Applications*, 100920. <https://doi.org/10.1016/j.elerap.2019.100920>
- Fadzil, F. (2017, December 19). *A Study on Factors Affecting the Behavioral Intention to Use Mobile Apps in Malaysia*. Papers.ssrn.com. [https://papers.ssrn.com/sol3/papers.cfm?abstract\\_id=3090753](https://papers.ssrn.com/sol3/papers.cfm?abstract_id=3090753)
- Fengmin, Z., Baijun, W., Jiangtao, B., Li, L., & Patwary, A. K. (2022). Investigating revisit intention of medical tourists in China through nutritional knowledge, perceived medical quality, and trust in the physiologist: A recommendation on health tourism policy measures. *Frontiers in Public Health*, 10, 893497.
- Forgasz, H., Tan, H., Leder, G., & McLeod, A. (2017). Enhancing survey participation: Facebook advertisements for recruitment in educational research. *International Journal of Research & Method in Education*, 41(3), 257–270. <https://doi.org/10.1080/1743727x.2017.1295939>
- Gupta, S., Mohindra, R., Jain, A., Singla, M., Sorsa, T., Räsänen, I., Malhotra, M., Soni, R. K., Kumar, A., Kanta, P., Gauba, K., Singh, M. P., Ghosh, A., & Suri, V. (2022). Toothbrush as a sampling methodology for detection of SARS-CoV-2. *Oral Diseases*, 28 Suppl 2, 2616–2617. <https://doi.org/10.1111/odi.14122>
- Hanafizadeh, P., Behboudi, M., Abedini Koshksaray, A., & Jalilvand Shirkhani Tabar, M. (2014). Mobile-banking adoption by Iranian bank clients. *Telematics and Informatics*, 31(1), 62–78. <https://doi.org/10.1016/j.tele.2012.11.001>
- Hazbar, A. M. H., Alem Mohammed, A., & Karim, A. K. A. (2019). An Empirical Study of Factors Influencing hotel customers' online booking Intention. *مجلة العلوم التربوية و الدراسات الإنسانية*, (5), 1-17.
- Ho, R. C., & Rajandram, K. V. (2016). The Influence of Social Media Data on Online Purchase. *Encyclopedia of E-Commerce Development, Implementation, and Management*, 2039–2050. <https://doi.org/10.4018/978-1-4666-9787-4.ch145>
- Kang, S. (2014). Factors influencing intention of mobile application use. *International Journal of Mobile Communications*, 12(4), 360-379.
- Li, L., Ragavan, N. A., Patwary, A. K., & Baijun, W. (2022). Measuring patients' satisfaction toward health tourism in Malaysia through hospital environment, nutritional advice, and perceived value: A study on Chinese exchange students. *Frontiers in public health*, 10, 893439.
- Li, L., Wu, B., & Patwary, A. K. (2022). How marine tourism promote financial development in sustainable economy: new evidences from South Asia and implications to future tourism students. *Environmental Science and Pollution Research*, 29, 1155-1172.

- Li, L., Wu, B., & Patwary, A. K. (2022). The psychosocial factors affecting chinese Outbound Exchange and mobility students' academic performance during COVID-19. *Frontiers in psychology*, 13, 872516.
- Liébana-Cabanillas, F., Sánchez-Fernández, J., & Muñoz-Leiva, F. (2014). The moderating effect of experience in the adoption of mobile payment tools in Virtual Social Networks: The m-Payment Acceptance Model in Virtual Social Networks (MPAM-VSN). *International Journal of Information Management*, 34(2), 151–166. <https://doi.org/10.1016/j.ijinfomgt.2013.12.006>
- Mahmood, Z. (2021). Web 2.0, social media, and mobile technologies for connected government. In *Web 2.0 and Cloud Technologies for Implementing Connected Government* (pp. 1-18). IGI Global.
- Martins, C., Oliveira, T., & Popovič, A. (2014). Understanding the Internet banking adoption: A unified theory of acceptance and use of technology and perceived risk application. *International Journal of Information Management*, 34(1), 1–13. <https://doi.org/10.1016/j.ijinfomgt.2013.06.002>
- Mcdaniel, C., & Gates, R. (n.d.). *Preface VII 1 Introduction to Marketing Research 1 Nature of Marketing 2 The Marketing Concept 2 Opportunistic Nature of Marketing Research 2 External Marketing Environment 3 Marketing Research and Decision Making 4 Marketing Research Defined 4 Importance of Marketing Research to Management 4 Understanding the Ever-Changing Marketplace 6 Social Media and User-Generated Content 6 Proactive Role of Marketing Research 7 Applied Research versus Basic Research 7 Nature of Applied Research 8 Decision to Conduct Marketing Research 9 Development of Marketing Research 11 Inception*. <https://doc1.bibliothek.li/aca/FLMF037627.pdf>
- Oladele, F., & Oyewole, T. G. (2020). Literature Discourse. *Social Media, Mobile and Cloud Technology Use in Accounting: Value-Analyses in Developing Economies*, 9–80. <https://doi.org/10.1108/978-1-83982-160-820201004>
- Patwary, A. K., Roy, B., Hoque, R., & Khandakar, M. S. A. (2019). Process of developing a community based tourism and identifying its economic and social impacts: An Empirical study on Cox's Bazar, Bangladesh. *Pakistan Journal of Humanities and Social Sciences*, 7(1), 1-13.
- Rehman, A. U., Bashir, S., Mahmood, A., Karim, H., & Nawaz, Z. (2022). Does e-shopping service quality enhance customers' e-shopping adoption? An extended perspective of unified theory of acceptance and use of technology. *PLOS ONE*, 17(2), e0263652. <https://doi.org/10.1371/journal.pone.0263652>
- Sari, F. P., Rhamadan, H., & Shihab, M. R. (2016, October 1). The effects of customization and permission on location-based advertising toward consumer behavioural intention. <https://doi.org/10.1109/ICACISIS.2016.7872759>
- Slade, E., Williams, M., Dwivdei, Y., Dwivdei, & Yogesh. (2013). *Extending UTAUT2 To Explore Consumer Adoption Of Mobile Payments*. 36. <https://core.ac.uk/download/pdf/301360866.pdf>
- Sumethokula, P., Patwary, A. K., Srinuanpanc, B., Srinuanpand, C., Suwandee, P., Thammathikul, A., & Phanong, W. (2020). The potential of new tour repackaging for creative tourism



- among entrepreneurs in Nakhon Si Thammarat. *International Journal of Innovation, Creativity and Change*, 13(10), 1752-1771.
- Trust and TAM in online shopping: An integrated model - ProQuest*. (n.d.). Wwww.proquest.com. Retrieved January 17, 2023, from [https://search.proquest.com/openview/a609d4f63d059424c8cf3169b6258921/1.pdf?pq-origsite=gscholar&cbl=36245&casa\\_token=VBQ03eq32B4AAAAA:mtGVmYlQB9nzu8C4oi9btLUnzoux7yXTGTbstqYDyvdmIS7DLxEDM-E6fdITSQpvLEUFU-wSbjf4](https://search.proquest.com/openview/a609d4f63d059424c8cf3169b6258921/1.pdf?pq-origsite=gscholar&cbl=36245&casa_token=VBQ03eq32B4AAAAA:mtGVmYlQB9nzu8C4oi9btLUnzoux7yXTGTbstqYDyvdmIS7DLxEDM-E6fdITSQpvLEUFU-wSbjf4)
- Walton, S., Thong, J., & Xu, X. (n.d.). *CONSUMER ACCEPTANCE AND USE OF INFORMATION TECHNOLOGY: EXTENDING THE UNIFIED THEORY OF ACCEPTANCE AND USE OF TECHNOLOGY* 1 Viswanath Venkatesh. <https://asset-pdf.scinapse.io/prod/3125976894/3125976894.pdf>
- Wang, X., Yu, C., & Wei, Y. (2012). Social Media Peer Communication and Impacts on Purchase Intentions: A Consumer Socialization Framework. *Journal of Interactive Marketing*, 26(4), 198–208. <https://doi.org/10.1016/j.intmar.2011.11.004>
- Wu, B., Liu, S., Wang, J., Tahir, S., & Patwary, A. K. (2021). Assessing the mechanism of energy efficiency and energy poverty alleviation based on environmental regulation policy measures. *Environmental Science and Pollution Research*, 28, 40858-40870.
- Wu, B., Zhai, B., Mu, H., Peng, X., Wang, C., & Patwary, A. K. (2021). Evaluating an economic application of renewable generated hydrogen: A way forward for green economic performance and policy measures. *Environmental Science and Pollution Research*, 1-15.
- Xu, J. (David), Benbasat, I., & Cenfetelli, R. T. (2013). Integrating Service Quality with System and Information Quality: An Empirical Test in the E-Service Context. *MIS Quarterly*, 37(3), 777–794. <https://doi.org/10.25300/misq/2013/37.3.05>
- Zhou, T., & Li, H. (2014). Understanding mobile SNS continuance usage in China from the perspectives of social influence and privacy concern. *Computers in Human Behavior*, 37, 283–289. <https://doi.org/10.1016/j.chb.2014.05.008>

# **The Factors That Influence The Malay Community In The Use Of Accommodation Technology Applications In Kota Bharu, Kelantan.**

Muhammad Hisham Bin Buyong Surja, Muhammad Haiqal Solihin Bin Mat Salleh,  
Muhammad Faries Bin Khairul Hasni, Muhammad Firdaus Bin Abdul Jalil.

*Norizan Binti Musa\**

*Faculty Of Hospitality, Tourism And Wellness, University Malaysia Kelantan*

---

## **ABSTRACT**

*This study is about the factors that influence the Malay community in using accommodation applications in Kota Bharu, Kelantan. Youth are a vulnerable group with the various technologies and applications available today. Therefore, this research is focused on the young people in Kota Bharu, Kelantan. This research is to identify the ease of use in simple accommodation applications and behavioural intentions. Second, to examine whether the facilities provided in the accommodation application and behavioural intention. Finally, to examine the relationship between the security provided in the accommodation application and behavioural intention. Quantitative methods were chosen and used in this study in the form of a questionnaire. Total of 120 Malay community respondents who use accommodation application facilities in Kota Bharu, Kelantan, Malaysia were selected in this study and from that number, a total of ten people respondents were interviewed in depth.*

**Keywords: Influence Malay Community, Technology Accommodation Application**

---

## **INTRODUCTION**

This chapter will discuss background of study, problem statement and follow by research objective, research question, significance of the study. definition of terms and lastly summary. All related above will be described in the title factors that Malay community in using accommodation applications in Kota Bharu, Kelantan.

The focus of the study is the accommodation application, a peer-to-peer short-term rental business that enables users to post and reserve rooms using a website and mobile application. Customers who have experience utilizing accommodation applications in order to create various marketing strategies. These studies' specific objectives were as follows: First, to determine the make-up of the elements that impact Malay community usage of the accommodation application, second, to determine if the accommodation application is user-friendly, and third, based on the findings of this study, to learn more about this study.

There were three objectives of this research:

1. To identify the between ease of use and behavioural intention in the usage of accommodation applications in Kota Bharu, Kelantan.

2. To examine the relationship between convenience and behavioural intention to utilise accommodation applications in Kota Bharu, Kelantan.
3. To investigate the relationship between security and behaviour intention to utilise accommodation applications in Kota Bharu, Kelantan.

## **SIGNIFICATION OF THE STUDY**

### **Community**

The purpose of this study is to evaluate the value and security of accommodation application services for the tourism industry. Based on this study, the information gathered will assist the community in evaluating the advantages and disadvantages of accommodation application. The neighbourhood can learn about the efficiency and safety of using accommodation application as a result, which may persuade the neighbourhood to be using accommodation application.

### **Competition Analysis**

By analysing the relevant motivators and restrictions, the study offers greater insights into the decision-making process of both guests and hosts. It will also help the accommodation application platform determine how it differs from other vacation rental services and the conventional hotel business. The importance of the study will help policymakers better control the accommodation application phenomenon by giving them a thorough understanding of the micro and macro environments.

### **Intentions Of Young**

This study can help to reveal the intentions of young people to engage in Airbnb apps. According to a study conducted by Assistant Professor Daniel Guttentag at Ryerson University's Ted Rogers School of Hospitality and Tourism Management, which was conducted in August 2016 and the findings of which were published, the straightforward response is, in fact, that it is inexpensive. Furthermore, the survey found that "convenient location" and "household amenities" were two other important driving factors for travellers.

## **LITERATURE REVIEW**

### **Behavioural Intentions**

Behavioural intentions refer to the perceived likelihood or subjective probability of an individual to engage in a given behaviour. In the context of retailing, this concept can be defined as the consumer willingness to develop some categories of behaviours such as referrals, price sensitivity, repurchase, complaining behaviour, loyalty and word of mouth (Zeithaml et al., 1996).

## Ease Of Use

Ease of use is one of Airbnb's core values. As a result, they must ensure that users can easily use Airbnb's webpages and smartphone apps. We are all aware that the circulation of modern times is accelerating with the development of advanced technology.

Therefore, the use of accommodation applications is very necessary because it can make it easier for users to make any booking online. For example, users can find out information related to a place they want to go to. In addition, it is also easy for users to book the accommodation and they do not have to bother to go to the place. Clearly showing that it is easy to use is one of the factors that influence the attraction of users in using accommodation applications. Perceived ease of use refers to the user's belief that using an application or website is easy (cheema, 2009).the tendency to accept technology is strongly influenced by the perception of ease of use (juniwati, 2014).

## Convenience

Everything nowadays centres around access. With a burgeoning millennial population, one factor driving ride sharing purchases is convenience. It is now possible because the sharing economy relies on real-time transactions via cell phones that connect providers and buyers. Consumers today expect everything to be speedy, and if they really do not acquire it on time, they assume the systems cannot be trustworthy. In order to achieve customer satisfaction, Habibi et al. (2017) emphasise the importance of convenience, efficiency, and, most significantly, accessibility.

## Security

Security is a priority in technology. Identity fraud and credit card fraud are two common attacks that occur when customers provide data through websites. Security, often known as privacy risk, relates to the acquisition and use of users' personal details by crowdfunding platform providers in an unfavorable manner (Gao et al., 2015). Participation in the sharing economy requires the disclosure of personal information, which causes users tremendous anxiety (Ballus-Armet et al., 2014). Although this is an important barrier to the sharing economy, it has overcome the barrier of distrust, allowing users to continue using the sharing function by verifying and verifying its customers and providers to protect each other. Therefore, it is imperative to protect customer privacy. With the security provided, users do not need to worry about their safety. For example, personal information. According to researchers, effective security increases confidence (Alrawabdeh et al., 2012; Kima et al., 2010).

## Research Hypothesis

The research's hypothesis is based on the study's elements, including economic, environmental, cultural, and community factors that influence the choice of domestic tourism destinations. The hypothesis had been developed and was going to be evaluated based on the investigation.

H1: Tourists' behavioural intention to utilise accommodation applications is significantly influenced by effort expectation.

H2: Tourists' behavioural desire to utilise accommodation applications is significantly influenced by performance expectation.

H3: The behavioural intention of travellers to utilise accommodation applications is significantly influenced by habit.

H4: Social conditioning has a considerable positive impact on travellers' behaviour intention to use accommodation apps.

H5: Hedonic motivation influences travellers' behavioural intention to utilise accommodation applications significantly.

### Conceptual Framework

The conceptual framework displays the relationship between the independent variable and dependent variable used in the study. There are three independent variable (IV) have been used in this study which are easy of use the accommodation application, the convenience and also the security of the accommodation application. The dependent variable (DV) is behavioural intention.

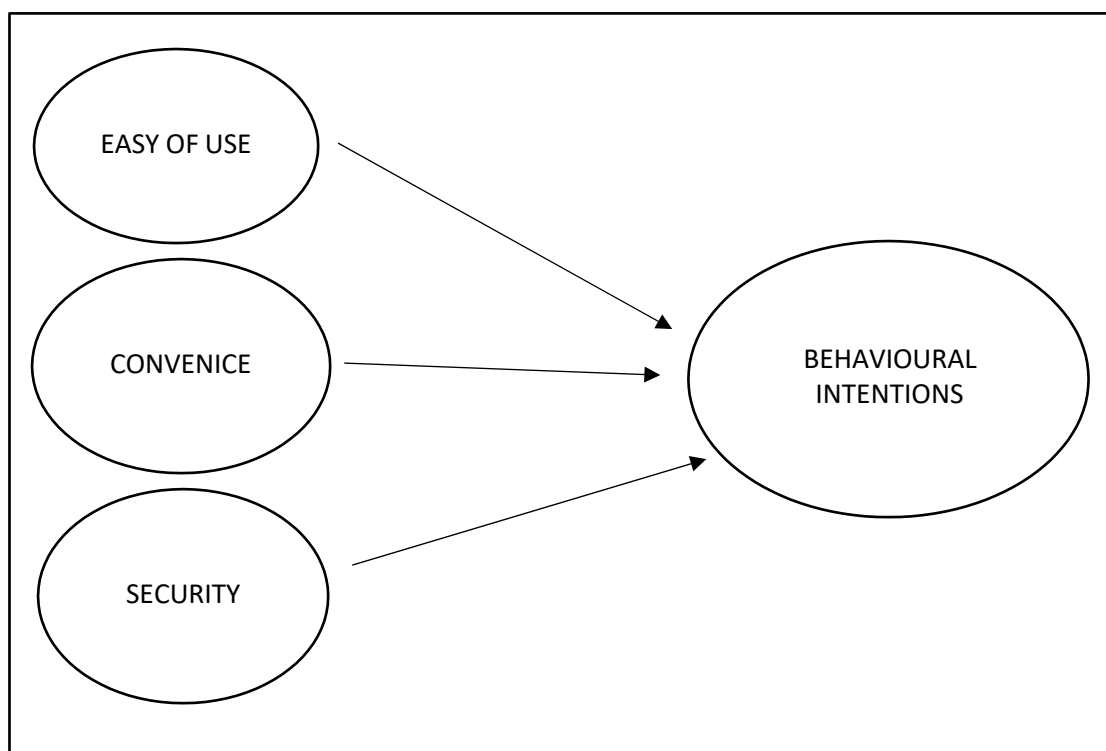

Figure 1 : Conceptual Framework

## METHODOLOGY

### Research Design

Defined research design as procedures for collecting, analysing, interpreting, and reporting data in research studies (Creswell and Plano -Clark,2007). The study's design specifies how the relevant information will be obtained, analysed, and used to answer the research question (Grey, 2014). The subject of research design is the examination of a scenario or problem to discover if one item causes another (Creswell, 2003). There are three types of research methodologies: mixed methods, qualitative design, and quantitative design (Creswell & PlanoClark, 2007). According to Denzin and Lincoln (2008), qualitative research strives to give the researcher with a way of comprehending a phenomenon by seeing or interacting with study participants (Teddlie &Tashakkori, 2009).

### Population

The phrase "population" refers to the entire group of individuals, occasions, or objects that researchers are curious about learning more about (Kumar, 2013). Local, malay community using the accommodation applications in Kota Bharu, Kelantan, which make up the study's population. The number youngster that uses the accommodation applications is about young people from 18 to 29 years old - 69 565 people.

### Sample Size

The subset of a population that is necessary to ensure that there is enough information available to draw conclusions is known as the sample size (Sekaran & Bougie, 2010). The sample population for this study consists of local tourists who use lodging booking websites in Kota Bharu, Malaysia's Kelantan province. 120 respondents will be picked from the population of local visitors in accordance with Krejcie & Morgan's (1970) sample size table to provide.

### Sampling Method

This is the method of figuring out how many elements should be included in a community (Kumar, 2013). The researchers choose certain subsets of the population to use as sample subjects for their sampling technique. Sampling techniques and non-probability sampling are the two available types of sampling procedures.

### Data Collection Procedure

It is possible to collect data from both primary and secondary sources. Gathering information from real sources, such as customers, users or non-users, or other research participants, specifically for the topic at hand, is known as primary data research. "Secondary data research" refers to any published material that has been specifically acquired for the current study challenge. 364 respondents who are among those who have used accommodation applications in Kota Bharu, Kelantan will provide the primary information gathered from the questionnaires.

## Research Instrument

In this study, we used the survey approach using online questions via Google Form to collect data in order to collect all of the necessary information to finish this research. Furthermore, because it is standardised, this type of research is typically less expensive than other ways and easier to maintain. Because this study included a high number of respondents, researchers used this strategy to collect data and information because it is an efficient way of collecting data and information.

## Data Analysis

The data was analysed using descriptive language. Descriptive analysis will be used to characterise the demographic profile of the respondents, including the percentage, frequency, mean, and average mean. Inferential analysis is used to investigate the relationship between independent and dependent variables. Pearson Correlation is a statistical method for determining the strength of a link between independent and dependent variables based on the magnitude of the correlation coefficient. (Piaw, 2006).

## FINDINGS

### Results of Frequency Analysis

Most respondents were young adults in Malaysia; the majority were male (51%), and the remaining respondents (49%) were female. Regarding their age, the age of the respondents varied between 19 years below until 56 years and above. More than half of the respondents (67.5%) aged between 20-24 years, (13.3%) of them aged from 25-29 years, ( 8.3%) of them aged from 35-39 years, (6.7%) of them aged 30-34 years,( 2.5%) of them aged 40 years above, ( 1.7% ) of them are aged 19 years and below. As for the respondents, the status of married are the majority of respondent ( 75.8% ), compared to single ( 21.7% ) and others ( 2.4% ). For highest education degree are the most ( 56.7%), ( 17.5% ) diploma , (14.2% ) STPM, (11.7%) SPM. The majority of income ( 66%) RM 0 – RM 1000, ( 23% ) from RM 2001 – RM 2500, ( 13%) from RM 1001 – RM 2000, ( 11% ) from RM 2501 – RM 3000, ( 5 % ) from RM 3501 and above, ( 2% ) RM 3001 – RM 3500. Most of respondent visit Kelantan ( 67.5 % ) from 04, (22.5%) from 10 and above, (9.2%) from 5 – 7, while 8-9 ( 0.8% ). Occupation for unemployed are the most ( 55.8 % ), comparing ( 25%) for self-employed, government for (13.3% ), non-government (5%), businessman ( 0.8% ). Only ( 76.7%) who stay in hotel at Kelantan while (23.3%) say no. Meanwhile, ( 82.5% ) using Air BnB app and ( 17.5% ) not using the app.

Characteristics	Frequency	Percentage (%)
<b>Gender</b>		
Male	61	51
Female	59	49
<b>Age</b>		
19 years – below	2	1.7
20-24 years	81	67.5
25-29 years	16	13.3

30-34 years	8	6.7
35-39 years	10	8.3
40 years – above	3	2.5
<b>Status</b>		
Single	26	21.7
Married	91	75.8
Divorced man	1	0.8
Divorced woman	1	0.8
Widow	1	0.8
<b>Highest Education</b>		
Diploma	21	17.5
Degree	3	2.5
Degree	65	54.2
Spm	17	14.2
Stpm	14	11.7
<b>Stay in Kelantan Hotel</b>		
No	28	23.3
Yes	92	76.7
<b>Use Air BnB App</b>		
No	21	17.5
Yes	99	82.5
<b>Income</b>		
RM 0 - RM1000	66	66
RM1001 - RM2000	13	13
RM2001 - RM2500	23	23
RM2501 - RM3000	11	11
RM3001 - RM3500	2	2
RM3501 and above	5	5
<b>How often visit Kelantan</b>		
0 - 4	81	67.5
5 - 7	11	9.2
8 - 9	1	0.8



10 and above	27	22.5
<b>Occupation</b>		
Government	16	13.3
Non – government	6	5.0
Businessman	1	0.8
Unemployed	67	55.8
Self-Employed	30	25.0
<b>TOTAL</b>	120	100

## Result of Descriptive Analysis

The mean score and standard deviation of the variable are shown in Table 2. The factors can be considered low if the mean score is from 1.00 to 1.99 and high if the mean score from 2.00 to 4.00. Table 2 shows result of descriptive analysis:

Table 2: Descriptive Analysis

VARIABLES	ITEMS	MEAN	STANDARD DEVIATION
<b>Convenience</b>	1. Where to stay plays an important role in choosing a destination to visit.	4.37	0.800
	2. Before the trip starts, I plan to choose a place to stay to immerse myself in the local culture.	4.17	0.863
	3. I decide which destinations to visit only based on where I want to stay.	4.08	0.881
	4. Usually, I do research about accommodation using an accommodation booking application before I start my trip.	4.27	0.710
	5. Before starting the trip, one thing I expect is to have a good environment.	4.37	0.744
	6. I want to try a new culture in the chosen accommodation.	4.27	0.827
	7. The involvement of the convenience application to book a place to stay is interesting.	4.26	0.750
<b>Ease of use</b>	8. Involvement of the convenience application to book a place to stay is easy to use.	4.27	0.742
	9. The engagement of the convenience app to book a place to stay is valuable.	4.25	0.781
	10. The involvement of the convenience application to book a place to stay is very meaningful.	4.36	0.754
	11. Involvement of the convenience application to book a place to stay is desirable.	4.33	0.735
	12. I obtained good results when using the convenience application to book accommodation when visiting the state of Kelantan.	4.14	0.725
<b>Security</b>	13. I feel safe when using the accommodation application to book accommodation in Kelantan.	4.17	0.781
	14. My personal information is protected if I use the convenience application when booking accommodation in Kota Bharu, Kelantan.	4.18	0.763
	15. Compared to other tourist destinations, staying in Kelantan is very worthwhile.	4.20	0.784

	16. I got the experience of booking a suitable place through the accommodation application when visiting Kelantan with reasonable expenses.	4.10	0.814
	17. The experience of staying in Kelantan gave me great satisfaction	3.92	0.816
	18. The experience of staying in Kelantan made me happy	4.06	0.823
	19. The experience of staying in Kelantan met my expectations.	4.06	0.813
	20. The experience of staying in Kelantan exceeded my expectations	4.04	0.893

Table 2 shows the mean and standard deviation 20 statements under three independent variables and four statements under the dependent variable based on the survey involving 120 respondents. The results in table 2 above shows that item of Convenience (Where to stay plays an important role in choosing a destination to visit.) has the highest mean score ( $M = 4.37$ ,  $SD = 0.800$ ) meanwhile item Convenience (I decide which destinations to visit based solely on where I want to stay.) has the lowest mean score ( $M = 4.08$ ,  $SD = 0.881$ ). As for the item of Ease of use (The involvement of the convenience app to book a place to stay is very meaningful.) has the highest mean score ( $M = 4.36$ ,  $SD = 0.754$ ). Meanwhile item of Ease of use (I got good results when using the convenience app to book accommodation when visiting the state of Kelantan.) has the lowest mean score ( $M = 4.14$ ,  $SD = 0.725$ ). Furthermore, for the item of Security (Compared to other tourist destinations, staying in Kelantan is very worthwhile) has the highest mean score ( $M = 4.20$ ,  $SD = 0.784$ ). Other than that, for the item Security (The experience of staying in Kelantan gave me great satisfaction) has the lowest mean score ( $M = 3.92$ ,  $SD = 0.816$ ).

### **Pearson Correlation Analysis**

One of the important statistical methods for determining the linear relationship between two numerical variable is the Pearson correlation test. This study has two parts such as independent variables and dependent variables, which influence the Malay Community in the use of accommodation technology applications in Kota Bahru, Kelantan. The three factors that make up the independent variables are Easy of Use, Security and Convenience. Pearson's correlation is being used to provide a more accurate measure with the aim of determining whether the correlation coefficient is significant.

Table 3: Show the coefficient range, r

Coefficient range, r	Strength of association
0.91 to 1.0 / -0.91 to -1.0	Very strong
0.71 to 0.90 / -0.71 to -0.90	High
0.51 to 0.70 / -0.51 to -0.70	Moderate
0.31 to 0.50 / -0.31 to -0.50	Small but define relationship/weak
0.01 to 0.30 / -0.01 to -0.30	Slight, Almost negligible

**Table 4.1: Correlation between independent variable and dependent variable.**

Table 3 shows a significant relationship between each independent variable (Safety, convenience and Ease of Use, with the dependent variable, behavioural intention. Based on the results, there is a relationship between the independent and dependent variables. Therefore, the following hypothesis is accepted:

<b>Correlations</b>			
		Accommodation Application Involvement	Accommodation Application Related Motivation
Accommodation Application Involvement	Pearson Correlation	1	.776**
	Sig. (2-tailed)		.000
	N	120	120
Accommodation Application Related Motivation	Pearson Correlation	0.776**	1
	Sig. (2-tailed)	.000	
	N	120	120
**. Correlation is significant at the 0.01 level (2-tailed).			

<b>Correlation</b>
--------------------

		Accommodation Application Related Motivation	Perceived Value
Accommodation Application Related Motivation	Pearson Correlation	1	.648**
	Sig. (2-tailed)		.000
	N	120	120
Perceived Value	Pearson Correlation	0.648**	1
	Sig. (2-tailed)	.000	
	N	120	120
**. Correlation is significant at the 0.01 level (2-tailed).			

<b>Correlations</b>			
		Accommodation Application Related Motivation	Satisfaction
Accommodation Application Related Motivation	Pearson Correlation	1	.494**
	Sig. (2-tailed)		.000
	N	120	120
Satisfaction	Pearson Correlation	0.494**	1
	Sig. (2-tailed)	.000	
	N	120	120
**. Correlation is significant at the 0.01 level (2-tailed).			

## **DISCUSSION & RECOMMENDATIONS**

The findings of this study indicate that a variety of factors influence the Malay Community in the use of accommodation technology applications in Kota Bahru, Kelantan. The first research goal is language of the area. In order to interact with the community in an efficient manner, communicate in Bahasa Malaysia, the native language. Make sure that all of the promotional

materials, instructions, and user interfaces are provided in Bahasa Malaysia so that they are easier to comprehend and access.

The second goal is taking care of worries. It is important to address any worries or misunderstandings that members of the Malay community may have regarding the privacy, security, or dependability of accommodation technology applications. In order to foster trust and confidence, it is important to bring attention to the safety precautions, reviews, and suggestions contained within the applications. Other than that, work together with local accommodation providers including hotels, guesthouses, and homestays to encourage them to advertise their properties on the technological platforms. This may be accomplished by collaborating with these providers. Provide some sort of incentive or reward in order to encourage other suppliers to take part.

The third goal is partnerships with Accommodation Technology Application Providers. In order to give the Malay community in Kota Bharu with exclusive discounts, promotions, or special package deals, you should consider forming partnerships with accommodation technology application providers. Bring attention to the money-saving and other advantages offered by the use of these applications. We can also motivate contented users from the Malay community to spread the word about their great experiences using accommodation technology apps through word of mouth by encouraging them to do so. For the purpose of amplifying these testimonials, you should make use of social media platforms and local community networks. Lastly, we can offer the Malay community continual help and guidance in adopting and making use of accommodation technology applications. Create a dedicated hotline or customer support service in order to solve any questions or problems that they may experience.

## **CONCLUSION**

In conclusion, all independent variables such as Security, Ease of Use and Convenience have a positive correlation with the dependent variable which is Behavioural Intention. As a result, the analysis revealed that security, ease of use and convenience have a positive factors influence the Malay Community in the use of accommodation technology applications in Kota Bharu, Kelantan.

## REFERENCES

Asia Pacific Journal of Innovation and Entrepreneurship | Emerald Insight. (n.d).

Www.emerald.com. <https://www.emerald.com/insight/2398-7812.htm>

Wang, J., & Ritchie, B. W. (2012). Understanding accommodation managers' crisis planning intention: An application of the theory of planned behaviour. *Tourism*

*Management*, 33(5), 1057–1067. <https://doi.org/10.1016/j.tourman.2011.12.006>

Sci-Hub | *Understanding accommodation managers' crisis planning intention: An application of the theory of planned behaviour. Tourism Management*, 33(5), 1057–1067 | 10.1016/j.tourman.2011.12.006. (n.d.). Sci-Hub.se. Retrieved January 2, 2023, from [https://scihub.se/https://www.sciencedirect.com/science/article/abs/pii/S02615177110](https://scihub.se/https://www.sciencedirect.com/science/article/abs/pii/S0261517711002597)

[02597](https://scihub.se/https://www.sciencedirect.com/science/article/abs/pii/S0261517711002597).

Hoffman, D. M., Girshick, A. R., Akeley, K., & Banks, M. S. (2008). Vergence–accommodation conflicts hinder visual performance and cause visual fatigue. *Journal of Vision*, 8(3), 33. <https://doi.org/10.1167/8.3.33>

Fauzi, N., & Awaluddin, N. I. (2017). Evaluating the Urban Heat Effects of High Rise NonGreen Buildings: A Case Study in Kota Bharu, Kelantan, Malaysia. *Journal of Tropical*

*Resources and Sustainable Science (JTRSS)*, 5(2), 66–70.

<https://doi.org/10.47253/jtrss.v5i2.599>

Kim, K., Jeon, S., & Kim, J. (2019). A study on the Selection Attributes of Accommodation Applications. *International Journal of Advanced Smart Convergence*, 8(4), 130–137.

<https://doi.org/10.7236/IJASC.2019.8.4.130>

Nguyen, Q. (2014). A Study of Airbnb as a Potential Competitor of the Hotel Industry. *UNLV Theses, Dissertations, Professional Papers, and Capstones*.

<https://doi.org/10.34917/8349601>

Davis, F. D. (2015). Perceived usefulness, perceived ease of use, and user acceptance of Information Technology. *MIS Quarterly*, 13(3), 319. <https://doi.org/10.2307/249008>

Chellappa, R. K., & Pavlou, P. A. (2022). Perceived Information Security, financial liability and Consumer Trust in Electronic Commerce Transactions. *Logistics Information Management*, 15(5/6), 358–368. <https://doi.org/10.1108/09576050210447046>

The effect of security, trust and ease of use towards repurchase ... (n.d.). Retrieved January 10,2023, from <https://www.researchgate.net/publication/344564327>

The effect of perceived ease of use and perceived security toward ... (n.d.). Retrieved January 10, 2023, from <https://www.researchgate.net/publication/350836196>

The effect of security, trust and ease of use towards repurchase ... (n.d.). Retrieved January 10,2023, from <https://www.researchgate.net/publication/344564327>

Trivedi, S.K. and Yadav, M. (2020), "Repurchase intentions in Y generation: mediation of trust and e-satisfaction", *Marketing Intelligence & Planning*, Vol. 38 No. 4, pp. 401-415.

<https://doi.org/10.1108/MIP-02-2019-0072>



# IMPACTS OF ECOTOURISM DEVELOPMENT TOWARD QUALITY OF LIFE AMONG LOCAL COMMUNITIES IN DABONG, KELANTAN

**Muhammad Idam bin Mustapha, Muhammad Irfan Aizat bin Zuraini,  
Muhammad Izzat bin Mohd Daud, Muhammad Kamal Danial bin Wirazimi  
& Dr. Aikal Liyani binti Mohamad Rasdi.**

*Faculty of Hospitality, Tourism and Wellness, Universiti Malaysia Kelantan  
Corresponding email:*

## ABSTRACT

It is important to highlight ecotourism to the local community in Dabong. The level of knowledge of the local community in Dabong regarding ecotourism is low. This is because many do not know the meaning of ecotourism and this is very important to avoid environmental pollution. This study was conducted to try and evaluate the data obtained from the local community in Dabong to ensure whether this ecotourism has a positive impact whether politically, economically and socially in their lives. This study uses an quantitative method which is a questionnaire with 151 people from the local community who know about the surrounding area and have settled in Dabong with a projected number of years there. The information for this study was compiled after a detailed question and answer session.

**Keywords: Ecoturism, Local community in Dabong.**

## INTRODUCTION

The title Impacts of Ecotourism development towards quality of life among local residents in Dabong, Kelantan, shall describe everything said above. However, following the storm, Dabong has become a popular destination for both domestic and foreign tourists. The structure of Dabong, which is more of a natural occurrence, has led to the area becoming a popular spot for ecotourism. The three main tourist attractions in Dabong are The Fish Cave, Lata Kertas, and Lata Kenerong..

Ecotourism is a strategy for preserving a region's natural resources and biodiversity while taking poverty alleviation and rural development into consideration. It based its operations on the natural and cultural resources of the area and engages local populations in tourism-related activities. This study explores the effects of ecotourism programmes on people who live in and around tourist-friendly areas.

Ecotourism initiatives can only be considered "successful" from a development point of view if local communities have a degree of control over them and if they share the advantages associated with ecotourism activities. With a focus on exploring the advantages, effects, and difficulties of ecotourism development in the area, the study looks at the socioeconomic impact of ecotourism attractions in Dabong. The study's conclusions show that the ecotourism sector in the region generates advantages including better transportation networks, economic possibilities, increased family income, and job development. Furthermore, tourism also helps to stimulate economic growth (Nasir &

Wongchestha, 2022). Based on these findings, the study recommends that all tourism industry stakeholders take an active role in the region's ecotourism development at all stages and that tourism be included as a required subject or course in high schools, colleges, and universities to raise local awareness and boost the labor force. The study approach that will be used in Dabong, Kelantan comprises the creation of an algorithm to assess local activities as well as a collection of scientific and useful ecotourism locations.

The top destinations for ecotourism are chosen through expert review, which is also used to compile best practises and create a handicap system. Community-Based Ecotourism (CBET) is a kind of localised natural resource management that is based on the principles and methods of conservation. This study will look at how the growth of ecotourism affects the standard of living in the local community in Dabong, Kelantan.

## **SIGNIFICANCE OF THE STUDY**

Ecotourism development initiatives can assist local communities, but they also benefit travellers who travel to protected natural areas from all over the world. This research will also look at how well-informed locals and visitors are about potential quality issues in Dabong, which is good for both the nation's natural environment and the tourism sector.

## **LITERATURE REVIEW**

### **RELATIONSHIP BETWEEN SOCIAL CULTURAL IMPACTS TOWARDS QUALITY OF LIFE AMONG LOCAL COMMUNITIES**

From a social perspective, the growth of ecotourism has a favourable effect, i.e., improves and advances infrastructure amenities, infrastructure, and facilitates improved connection amongst community members. The benefits of ecotourism development can raise community standards of living and spur the growth of small and medium-sized businesses (SME) (James Et al, 2021). However, by promoting pride in cultural traditions and preventing urban redevelopment by generating local jobs, effects on tourism can be favourable and seen.

### **RELATIONSHIP BETWEEN COMMUNITY IMPACTS TOWARDS QUALITY OF LIFE AMONG LOCAL COMMUNITIES**

In addition to preserving biodiversity and natural resources, protected areas often benefit local communities or populations by generating revenue from tourists. The majority of nature tourism destinations are frequently found in remote or wilderness areas; yet, in order to protect the natural value and draw more visitors, basic but required facilities must be provided. The study's conclusions indicate that the perception of the tourism industry's effect from economic, social, cultural, and environmental viewpoints might affect the quality of life in the neighbourhood. In terms of the social aspect, the tourism sector's perspective can improve the neighbourhood's ability to communicate with visitors in other languages. Finally, from an environmental perspective, it has compelled the local population to preserve the reputation of the hamlet or tourist attraction. Greater efforts are now being made to encourage environmental conservation in order to maintain the environment's quality. Overall, the positive impact of tourism expansion can raise the standard of living in the neighbourhood.

## **RELATIONSHIP BETWEEN ECONOMIC IMPACTS TOWARDS QUALITY OF LIFE AMONG LOCAL COMMUNITIES**

Larger economic benefits from tourism growth contribute to the betterment of nearby towns. Malaysia's tourism industry, like that of many other countries, is typically measured in terms of dollars and cents, notably the quantity of arriving and spending foreign visitors. In Malaysia, the number of visitors increased from 23.65 million in 2009 to 25.72 million in 2013, bringing in RM 65.44 billion in 2013 as opposed to RM53.4 billion in 2009. According to Brown (1998), the combined effects of infrastructural upgrades and a rise in tourists show that travel has a mixed record of effects on the economy, culture, and environment. The Department of Statistics of Malaysia reports that the expansion in tourism has helped to increase tourist arrivals, income, and employment. According to the MTSA's 2005–2012 data, overall employment in the tourism industry rose by 4.7% in 2012 compared to 7.8% in 2011.

Tourism has many economic benefits, such as higher foreign exchange revenues, job possibilities, better social circumstances, and more market stability than conventional commodities exports. Local communities gain economically, physically, and socially from tourism activities, with the most immediate benefit being the creation of employment and the potential for individuals to enhance their income and level of life. The consequences of tourism vary by location, and include economic, environmental, socio-cultural, service-related, taxation, congestion, and community reactions.

The majority of individuals benefit financially from tourism resources, which raises their standard of living. Additionally, tourism benefits local communities by bringing in money, opening up new business and investment opportunities, and improving living circumstances. According to Courtney (1999), some of the positive changes brought about by tourism, such job opportunities, more money, and employment, may be appreciated by the locals.

## **IMPACTS OF ECOTOURISM DEVELOPMENT TOWARDS QUALITY OF LIFE AMONG LOCAL COMMUNITIES.**

Ecotourism has a great impact on the local community in Dabong, as it is the best way to ensure tourism in Malaysia remains stable and increase the country's income. Local residents can also carry out economic activities by working and earning their own income through business.

## **RESEARCH HYPOTHESES**

The literature review below shows independent variables such as the social, cultural, community and economic impact of the quality of ecotourism development services among the local community in Dabong, Kelantan.

H1: There is relationship between social cultural toward quality of life among local communities in Dabong, Kelantan.

H2: There is relationship between environment impacts toward quality of life among local communities in Dabong, Kelantan.

H3: There is relationship between economic impacts toward quality of life among. local communities in Dabong, Kelantan.

## RESEARCH FRAMEWORK

The link between the independent and dependent variables utilised in the study is shown by the conceptual framework. In this study, three independent variables (IVs), including visitor satisfaction, place attachment, and destination attractiveness, were employed. The destination loyalty DV is the dependent variable.

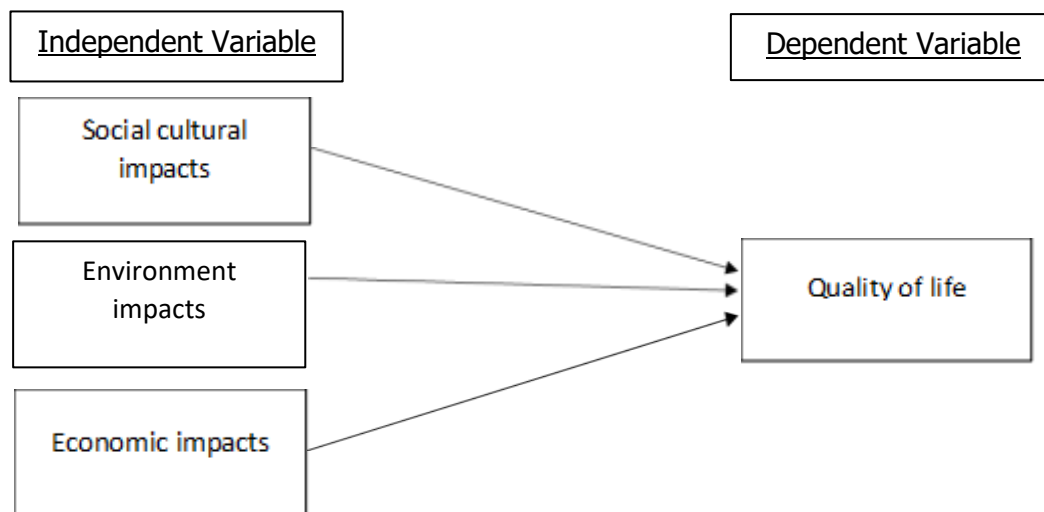

Figure 2.1: Conceptual Framework

## METHODOLOGY

### RESEARCH DESIGN

The process of developing an appropriate framework for a study is known as research design. Research methodologies may be divided into three categories: mixed methods, qualitative design, and quantitative design. Combining quantitative and qualitative research into a single study or collection of studies is known as mixed methods research. The quantitative research approach will be used in this study since it produces precise and measurable data that can be used to a huge population.

### DATA COLLECTION

Qualitative data is gathered in Dabong by community leaders or door-to-door surveys using spoken or written words, such as interviews, observations, records, and artefacts.

Secondary data is used to provide justification for judgements and quantitative research is used to investigate phenomena or events that affect people.

Primary data research is gathering information from real sources, while secondary data research is collecting published material for the current study challenge. Primary data will be collected from 152 respondents in Dabong, Kelantan, while secondary data will help make decisions clearer.

## SAMPLING

To get useful data for market research, researchers employ a variety of sampling techniques. In certain circumstances, like the early stages of a study or financial restrictions, non-probability sampling is more beneficial than other types of sampling. In our investigation, convenience sampling was used as the non-probability strategy.

## DATA ANALYSIS

Analysis of the connection between independent and dependent variables is done through descriptive analysis. Pearson A statistical method called correlation employs the correlation coefficient's magnitude to assess the strength of a relationship between independent and dependent variables.

## FINDINGS

**TABLE 1 : DEMOGRAPHIC ANALYSIS**

	Demographic characteristics	Frequency	Percentage (%)
Gender			
Male		82	54.3
Female		69	45.7
Age			
15 - 25 years		92	60.9
26 - 35 years		29	19.2
36 - 45 years		13	8.6
46 - 55 years		15	9.9
55 years above		2	1.3
Marital Status			
Married		39	25.8
Single		112	74.2
Occupation			
Government		15	9.9
NGO		15	9.9
Retired		5	3.3

Self-employed	19	12.6
Student	93	61.6
Unemployed	4	2.6

According to table 1 gender results, there are 82 responders who are men, or 54.3 percent of the total. While there are 45.7 responses who are female, or 45.7 percent of the total. Next, the results for respondents' ages, 60.9 percent, or 92 respondents, are between the ages of 15 and 25. There were 1.3 percent fewer responders in the 55 and older age group than there were overall. While the ages of 26 to 35, 36 to 45, and 46 to 55 had 29, 13, and 15 respondents, respectively, with percentages of 19.2%, 8.6%, and 9.9%. Based on the reply of respondents, single has the largest number of respondents which is 112 respondent and the percentage is 74.2%. The least respondents is married. The number married is 39 respondent and 25.8 %. According to the table, there were 93 respondents, the majority of them were students, making up 61.6% of the total. The second largest category in the statistics, with 19 respondents, or 12.6%, was self-employed. Government and NGO came in third with 15 respondents and a 9.9% response rate. Retired ranks fourth in the statistics with 5 respondents and 3.3%. The lowest percentage of respondents (4, or 2.6%), were unemployed.

**TABLE 2 : DESCRIPTIVE ANALYSIS**

Variables	N	Mean	Standard Deviation
Quality of life	151	17.62	2.432
Social cultural impact	151	16.92	2.849
Environmental impact	151	17.34	2.891
Economic impact	151	16.98	3.035

The mean and standard deviation of the dependent variables and independent factors were displayed in Table 1 by the number of respondents. The dependent variable's median value, or quality of life, is 17.62. The highest mean for independent variables is Environmental Impact (17.34), followed by Economic Impact (16.98), and Social Cultural Impact (16.92).

**TABLE 3 : RELIABILITY ANALYSIS**

Variable	Number of Item	Cronbach's Alpha coefficient	Strength of Association
Quality of Life	4	0.862	Very Good
Social Culture	5	0.890	Very Good
Environment	5	0.886	Very Good
Economic	5	0.872	Very Good
Overall Variables	19	0.961	Excellent

The aggregate Cronbach's Alpha Coefficient for the independent and dependent variables in this study was displayed in Table 3. Next, five questions were used to assess the quality of life in Dabong, Kelantan, and the Cronbach's Alpha result for the question in this part was 0.862, indicating extremely excellent. Five questions were used to assess the social and cultural influences on residents' quality of life in Dabong, Kelantan. Table 2 revealed that the question in this area had a very strong Cronbach's Alpha score of 0.890. As a result, the coefficients found for the social culture influences variable were accurate. Additionally, there were five questions to assess how the environment affected residents' quality of life in Dabong, Kelantan. This section's Cronbach's Alpha coefficient value is 0.886, which is deemed to be very excellent. Five questions were used to measure the economic effects on quality of life among local populations in Dabong, Kelantan.

**TABLE 4 : PEARSON CORRELATION ANALYSIS**

Table 4 below show the result of the Pearson Correlation Analysis

Correlations					
		DV	IV1	IV2	IV3
DV	Pearson Correlation	1	.788**	.781**	.774**
	Sig. (2-tailed)		.000	.000	.000
	Sum of Squares and Cross-products	887.232	818.921	824.285	857.258
	Covariance	5.915	5.459	5.495	5.715
	N	151	151	151	151
IV1	Pearson Correlation	.788**	1	.814**	.855**
	Sig. (2-tailed)	.000		.000	.000

	Sum of Squares and Cross-products	818.921	1218.19	1005.78	1108.85
	Covariance	5.459	8.121	6.705	7.392
	N	151	151	151	151
IV2	Pearson Correlation	.781**	.814**	1	.803**
	Sig. (2-tailed)	.000	.000		.000
	Sum of Squares and Cross-products	824.285	1005.78	1254.09	1057.68
	Covariance	5.495	6.705	8.361	7.051
	N	151	151	151	151
IV3	Pearson Correlation	.774**	.855**	.803**	1
	Sig. (2-tailed)	.000	.000	.000	
	Sum of Squares and Cross-products	857.258	1108.85	1057.68	1381.97
	Covariance	5.715	7.392	7.051	9.213
	N	151	151	151	151
**. Correlation is significant at the 0.01 level (2-tailed).					

The somewhat favourable association between social culture and quality of life was indicated by the correlation value of 0.788. The somewhat favourable link between environmental damages and quality of life was shown by the correlation value of 0.781. Table 3 displayed the 151 instances, the significant value, and the Pearson correlation coefficient. The somewhat favourable association between economic effects and quality of life was indicated by the correlation value of 0.774.

## DISCUSSION AND RECOMMENDATION

This study suggests further research on immigration, focusing on local tourists to Malaysia. The findings are consistent, but may vary if including foreign tourists. The study should ask other tourists to respond to the questionnaire, focusing on four characteristics affecting consumer behaviors among local Malaysian visitors.

Next, this study may overlook other factors affecting Malaysian residents' tourist behaviour, such as economic factors. Future research should consider larger sample sizes and employ interviews or open-ended questions to improve precision and dependability. Additionally, researchers should consider using a larger sample size and incorporating economic considerations to better understand the millions of domestic and international visitors to Malaysia.

The current study has several limitations, such as the time constraint, busy conditions, and respondents' reluctance to cooperate in answering online questionnaires. The researchers have tried to get respond quickly in a short time.



This study only looked at local tourists to Malaysia, but the findings may vary if it includes foreign tourists. To improve the precision and dependability of the study, researchers should ask other tourists to respond to the questionnaire. Additionally, larger sample sizes should be used to increase the precision and dependability of the study.

## **CONCLUSION**

The researcher used a Google Form to collect data, and both visitors and residents of Dabong submitted 150 replies. Google Forms was also used by the researcher to get replies from people all throughout Malaysia. This is because respondents find it easier to complete all of the surveys when utilising the Google form, which also saves the researcher time and money. The results from the preceding chapter and all of the survey data were then examined using a software tool named. The researchers utilise this programme because it makes it easy to comprehend all the information. Therefore, it is anticipated that all of the information supplied throughout this research will be helpful to the subsequent researcher.

## REFERENCES

- Ah-Choy, E., 2010. The nascent development of ecotourism in lagong hill. *Am. J. Applied Sci.*, 7: 1528-1531. DOI: 10.3844/ajassp.2010.1528.1531
- Akhtar, D. M. I. (2016). Research design. *Research Design* (February 1, 2016). <https://dx.doi.org/10.2139/ssrn.2862445>
- Akter, M., Sadekin, M. N., & Patwary, A. K. (2020). An Empirical Study on Students' Satisfaction from Mawlana Bhashani Science & Technology University, Bangladesh. *Review of Economics and Development Studies*, 6(2), 363-379.
- Alom, S., Patwary, A. K., & Khan, M. M. H. (2019). Factors affecting the turnover intention of Bangladeshi migrants in the United Arab Emirates: An empirical study on the hotel industry. *International Journal of Innovation, Creativity and Change*, 8(3), 344-360.
- Amir, A. F., Ghapar, A. A., Jamal, S. A., & Ahmad, K. N. (2015). Sustainable Tourism Development: A Study on Community Resilience for Rural Tourism in Malaysia. *Procedia - Social and Behavioral Sciences*, 168, 116–122. <https://doi.org/10.1016/j.sbspro.2014.10.217>
- Aspers, P., & Corte, U. (2019). What is qualitative in qualitative research. *Qualitative sociology*, 42(2), 139-160.
- Azizan, M., Aziz, A.H., Badaruddin, M., Ghapar, A.O. & Puad, A.M.S. (2011). Assesment of nature-based tourism in South Kelantan, Malaysia. *Tourismos : An International Multidisciplinary Journal of Tourism*, 281-295.
- Bahari, S. (2019, February 28). Ekopelancongan dan impak kepada Ekonomi, Sosial dan Alam Sekitar | MajalahSains. *MajalahSains | Sains & Teknologi Untuk Masyarakat*. <https://www.majalahsains.com/ekopelancongan-dan-impak-kepada-ekonomi-sosial-dan-alam-sekitar/>
- Bhuiyan, M.A.H., C. Siwar, S.M. Ismail and R. Islam, 2011. The role of home stay for ecotourism development in east coast economic region. *Am. J. Applied Sci.*, 8: 540-546. DOI: 10.3844/ajassp.2011.540.546
- Creswell, J. W. (2014). Qualitative, quantitative and mixed methods approaches. [http://155.0.32.9:8080/jspui/bitstream/123456789/1091/1/Qualitative,%20Quantitative,%20and%20Mixed%20Methods%20Approaches%20\(%20PDFDrive%20\)-1.pdf](http://155.0.32.9:8080/jspui/bitstream/123456789/1091/1/Qualitative,%20Quantitative,%20and%20Mixed%20Methods%20Approaches%20(%20PDFDrive%20)-1.pdf)
- Creswell, J. W. (2014). Qualitative, quantitative and mixed methods approaches. [http://155.0.32.9:8080/jspui/bitstream/123456789/1091/1/Qualitative,%20Quantitative,%20and%20Mixed%20Methods%20Approaches%20\(%20PDFDrive%20\)-1.pdf](http://155.0.32.9:8080/jspui/bitstream/123456789/1091/1/Qualitative,%20Quantitative,%20and%20Mixed%20Methods%20Approaches%20(%20PDFDrive%20)-1.pdf)
- D. Gursoy & D.G. Rutherford. Host Attitudes Toward Tourism: An Improved Structural Model. *Annals of Tourism Research*, 31, 3, (2004)
- D. Kreag. The impacts of tourism. Minnesota Sea Grant Program (2001)
- Daneshfar, S., & Moharami, M. (2018). Dynamic assessment in Vygotsky's sociocultural theory: Origins and main concepts. *Journal of Language Teaching and Research*, 9(3), 600-607. <http://www.academypublication.com/issues2/jltr/vol09/03/20.pdf>
- ECOTOURISM - Definisi ecotourism dalam kamus Corsica. (n.d.). <https://educalingo.com/ms/dic-en/ecotourism>
- Elena A. Dzhandzhugazova, Lyudmila B.-Zh. Maksanova, Taisiya B. Bardakhanova, Irina Y. Ponomareva, Ekaterina A. Blinova, (2019). Ecotourism Development in Russia: Analysis of

- Best Regional Practices. *Ekoloji Journal*. <http://www.ekolojidergisi.com/article/ecotourism-development-in-russia-analysis-of-best-regional-practices-5665>
- Elena Mondino, Thomas Beery, (2018). Ecotourism as a learning tool for sustainable development. The case of Monviso Transboundary Biosphere Reserve, Italy. *Journal of Ecotourism*. <https://www.tandfonline.com/doi/full/10.1080/14724049.2018.1462371>
- F. Brown. *Tourism Reassessed: Blight or Blessing?*. Guildford: ButterworthHeinemannSkidmore (1998)
- Fallon, L.D. and L.K. Kriwoken, 2003. Community involvement in tourism infrastructure-the case of the strahan visitor centre, Tasmania. *Tourism Manage.*, 24: 289-308. DOI: 10.1016/S0261-5177(02)00072-9
- Fengmin, Z., Baijun, W., Jiangtao, B., Li, L., & Patwary, A. K. (2022). Investigating revisit intention of medical tourists in China through nutritional knowledge, perceived medical quality, and trust in the physiologist: A recommendation on health tourism policy measures. *Frontiers in Public Health*, 10, 893497.
- Greer, S. (2017). *The concept of community: Readings with interpretations*. Routledge. <https://doi.org/10.4324/9781315131443>
- Hazbar, A. M. H., Alem Mohammed, A., & Karim, A. K. A. (2019). An Empirical Study of Factors Influencing hotel customers' online booking Intention. *مجلة العلوم التربوية و الدراسات الإنسانية*, (5), 1-17.
- Hisyam, C. J. (2021). *Sistem Sosial Budaya Indonesia*. Bumi Aksara. [https://books.google.com.my/books?hl=en&lr=&id=XuMhEAAAQBAJ&oi=fnd&pg=PA1&dq=maksud+sosiobudaya&ots=7rnWFVLMcq&sig=mlgjDdfcQUrfAjhKEXnP4Nc2yhM&redir\\_esc=y#v=onepage&q&f=false](https://books.google.com.my/books?hl=en&lr=&id=XuMhEAAAQBAJ&oi=fnd&pg=PA1&dq=maksud+sosiobudaya&ots=7rnWFVLMcq&sig=mlgjDdfcQUrfAjhKEXnP4Nc2yhM&redir_esc=y#v=onepage&q&f=false)
- J. Saarinen. Traditions of sustainability in tourism studies. *Annals of Tourism Research* 33, 4, (2006)
- Jaini, N., Robat, M., Annuar, A. N. A., & Jamaluddin, E. R. (2019). The identification of criteria for ecotourism practice in Peninsular Malaysia. *Journal of Hotel and Business Management*, 8(1), 190-195. <https://www.academia.edu/download/65958889/the-identification-of-criteria-for-ecotourism-practice-in-peninsular-malaysia-2169-200286-1000190.pdf>
- James, J., & Hussin, R. (2021). IMPAK AKTIVITI PELANCONGAN KE ATAS KOMUNITI SETEMPAT: TINJAUAN LITERATUR: IMPACT OF TOURISM ACTIVITIES ON THE LOCAL COMMUNITY: A LITERATURE REVIEW. *Journal of Borneo Social Transformation Studies*, 7(1), 211-224. <https://jurcon.ums.edu.my/ojums/index.php/jobsts/article/view/3612>
- Joung Hun Lee, Yoh Iwasa, (2020). Theoretical Ecology. Ecotourism development and the heterogeneity of tourists. *Springer Link Journal*. <https://link.springer.com/article/10.1007/s12080-020-00458-7>
- Just a moment. (n.d.). [https://www.researchgate.net/publication/305173936\\_Impact\\_of\\_local\\_community\\_quality\\_of\\_life\\_QoL\\_on\\_sustainable\\_development\\_of\\_pilgrimage\\_destinations\\_Mediating\\_role\\_of\\_destination\\_image](https://www.researchgate.net/publication/305173936_Impact_of_local_community_quality_of_life_QoL_on_sustainable_development_of_pilgrimage_destinations_Mediating_role_of_destination_image)
- Kamaruzaman, J. & Dahlan, H.T. (2008). Sustainable Forest Management Practices and Environmental Protection in Malaysia. *Wseas Transaction On Environment And Development*, 191-199.

- Kiss, A. (2004). Is community-based ecotourism a good use of biodiversity conservation funds? *Trends in Ecology & Evolution*, 19(5), 232-237. <https://doi.org/10.1016/j.tree.2004.03.010>
- Leavy, P. (2022). *Research design: Quantitative, qualitative, mixed methods, arts-based, and community-based participatory research approaches*. Guilford Publications.
- Lewis, C., Enciso, P. E., & Moje, E. B. (Eds.). (2020). *Reframing sociocultural research on literacy: Identity, agency, and power*. Routledge. [https://books.google.com.my/books?hl=en&lr=&id=agPzDwAAQBAJ&oi=fnd&pg=PT5&dq=concept+sociocultural&ots=k4g-SwMrOG&sig=BlhA\\_22anm2hue5zBi6wBX9cn6o&redir\\_esc=y#v=onepage&q=concept%20sociocultural&f=false](https://books.google.com.my/books?hl=en&lr=&id=agPzDwAAQBAJ&oi=fnd&pg=PT5&dq=concept+sociocultural&ots=k4g-SwMrOG&sig=BlhA_22anm2hue5zBi6wBX9cn6o&redir_esc=y#v=onepage&q=concept%20sociocultural&f=false)
- Li, L., Ragavan, N. A., Patwary, A. K., & Baijun, W. (2022). Measuring patients' satisfaction toward health tourism in Malaysia through hospital environment, nutritional advice, and perceived value: A study on Chinese exchange students. *Frontiers in public health*, 10, 893439.
- Li, L., Wu, B., & Patwary, A. K. (2022). How marine tourism promote financial development in sustainable economy: new evidences from South Asia and implications to future tourism students. *Environmental Science and Pollution Research*, 29, 1155-1172.
- Li, L., Wu, B., & Patwary, A. K. (2022). The psychosocial factors affecting chinese Outbound Exchange and mobility students' academic performance during COVID-19. *Frontiers in psychology*, 13, 872516.
- M.J. Walpole and H.J. Goodwin. Local economic impacts of dragon tourism in indonesia', *Annals of Tourism Research* (2000)
- Md Abud Darda, Md. Anowar Hossain Bhuyian, (2022). A Structural Equation Model (SEM) for the socio-economic impacts of ecotourism development in Malaysia. *Plos One Journal*. <https://journals.plos.org/plosone/article?id=10.1371/journal.pone.0273294>
- Md. Anowar Hossain Bhuiyan. (2019b). Homestay for Community Based Tourism Development at Kampung Jelawang in Kelantan, Malaysia. *SOCIALSCI JOURNAL*, 3, 73–81.
- MTSA, Malaysia Tourism Satellite Account 2005-2012, Department Of Statistic Malaysia (2005-2012)
- Nasir, M. N. M., & Wongchestha, N. (2022). Parallel Mediators of Place Attachment and Tourist Motivation in Involvement and Destination Loyalty: A Conceptual Model. *International Journal of Hospitality & Tourism Systems*, 15(2), 103-105.
- Negishi, T. (2014). *History of economic theory*. Elsevier. [https://books.google.com.my/books?hl=en&lr=&id=syDLCQAAQBAJ&oi=fnd&pg=PP1&dq=related:G4nxiwzz3EIJ:scholar.google.com/&ots=9mtD32gr5z&sig=ThxYj0RpUZe\\_g hA9f36BWJ1yOdg&redir\\_esc=y#v=onepage&q&f=false](https://books.google.com.my/books?hl=en&lr=&id=syDLCQAAQBAJ&oi=fnd&pg=PP1&dq=related:G4nxiwzz3EIJ:scholar.google.com/&ots=9mtD32gr5z&sig=ThxYj0RpUZe_g hA9f36BWJ1yOdg&redir_esc=y#v=onepage&q&f=false)
- Nurul Husna,(2021). Travelling in Dabong, Kelantan. *Harian Metro Newspaper*. <https://www.hmetro.com.my/santai/2021/09/760806/makan-angin-di-dabong>
- P. Brunt & P. Courtney. Host Perceptions of Socio Cultural Impacts. *Annals of Tourism Research*, 26, 3,(1999)
- P. Mason. *Tourism impacts, planning and management*. Jordan Hill, Oxford: ButterworthHeinemann (2003)
- Patwary, A. K., Roy, B., Hoque, R., & Khandakar, M. S. A. (2019). Process of developing a community based tourism and identifying its economic and social impacts: An Empirical

- study on Cox's Bazar, Bangladesh. *Pakistan Journal of Humanities and Social Sciences*, 7(1), 1-13.
- Ridho, T. K. (2016). The Influence of CSR on Performance and Its Determinants in Listed Companies in Indonesia, (10), 259-268.
- Sadan, V. (2014). Mixed methods research: A new approach. *International Journal of Nursing Education*, 6(1), 254.
- Scheyvens, R. (1999). Ecotourism and the empowerment of local communities. *Tourism Management*, 20(2), 245–249. [https://doi.org/10.1016/s0261-5177\(98\)00069-7](https://doi.org/10.1016/s0261-5177(98)00069-7)
- Sileyew, K. J. (2019). Research design and methodology (pp. 1-12). Rijeka: IntechOpen. <https://books.google.com.my/books?id=eqf8DwAAQBAJ>
- Singh, Y. K. (2006). Environmental science. New Age International.
- Sumethokula, P., Patwary, A. K., Srinuanpanc, B., Srinuanpand, C., Suwandee, P., Thammathikul, A., & Phanong, W. (2020). The potential of new tour repackaging for creative tourism among entrepreneurs in Nakhon Si Thammarat. *International Journal of Innovation, Creativity and Change*, 13(10), 1752-1771.
- Tangit, T. M., Hasim, A. K. M., & Adanan, A. (2014). Rural tourism at its peak: socio-cultural impacts towards host communities of Kinabalu Park, Sabah (Malaysian-Borneo). In SHS Web of Conferences (Vol. 12, p. 01097). EDP Sciences. <https://doi.org/10.1051/shsconf/20141201097>
- UNWTO . 2012 Tourism Highlights (2012)
- Wu, B., Liu, S., Wang, J., Tahir, S., & Patwary, A. K. (2021). Assessing the mechanism of energy efficiency and energy poverty alleviation based on environmental regulation policy measures. *Environmental Science and Pollution Research*, 28, 40858-40870.
- Wu, B., Zhai, B., Mu, H., Peng, X., Wang, C., & Patwary, A. K. (2021). Evaluating an economic application of renewable generated hydrogen: A way forward for green economic performance and policy measures. *Environmental Science and Pollution Research*, 1-15.

# THE IMPACT OF TOURISM DEVELOPMENT TOWARDS QUALITY OF LIFE AMONG LOCAL COMMUNITY IN PULAU SURI KELANTAN

*Muhammad Muslim Bin Zakaria, Muhammad Nazifi Bin Yaakub, Muhammad Mustaqim Bin Aling, Muhammad Nurhafiz Bin Ramlan & \*Aikal Liyani Binti Mohd Rasdi*

*Faculty of Hospitality, Tourism and Wellness, Universiti Malaysia Kelantan*  
*Corresponding email: [liyani.r@umk.edu.my](mailto:liyani.r@umk.edu.my)*

---

## ABSTRACT

Tourism has become an activity that is familiar to generate and improve the private economy and also to benefit the national economy, it allows local communities to create opportunities for tourists to learn about their culture and promote their own history and stories (López-Guzmán et al. Local communities must provide services to tourists based on the initiative and management of their natural and cultural resources. In Kelantan, Pulau Suri is one of the unique places for the development of economic tourism. Therefore, their objective when traveling is not only to discover new locations but also local culture, ethics, and historical sites where they can have an authentic and meaningful experience based on their own perception. In order to answer research collection, test hypotheses, and evaluate results, data collecting is a procedure that involves gathering and methodically quantifying information on variables of interest. The data collection process had been done from 19 May 2023 till 21 May 2023, the researcher spread the questionnaire to the local community for answers the question. Data collecting is used in many different types of study, including the natural and social sciences, humanities, business, and others. Quantitative methods were used in this study which is 160 respondents have been chosen to answer the questionnaire.

---

**Keywords: Tourism, Socioeconomic, Quality of life, Community**

---

## INTRODUCTION

Since it enables local communities to develop possibilities for visitors to learn about their culture and promote their own history and stories, tourism has come to be known for generating and enhancing the private economy as well as benefiting the national economy (López-Guzmán et al., 2011). Local communities must take the initiative and manage their natural and cultural resources in order to give services to tourists. Tourists will benefit from better access between locations if this is done. Based on these elements, it is commonly

acknowledged that local communities play a crucial role in the development of the tourism industry and in future tourism growth (Butler and Pearce, 2003; Mason, 2003; Telfer and Sharpley, 2007).

Tourism will make locals feel unappreciated if they are not properly empowered and involved in the development of local tourism. As a result, it will be less probable that they will earn tourism money (Lea, 1988). Possibly, the potential of local people and local knowledge raises the likelihood that community involvement can play a central role in tourism development. The engagement of the local community is essential in the tourism business because it may ensure that tourists have a memorable experience and can visit a variety of attractive locations, thereby generating revenue for the community. Due to their familiarity with the area, locals provide decision-makers with vital supporting data. Therefore, tourism development must utilise the population's potential to entice locals to join the tourism business. By doing so, chances to access markets and establish enterprises in the community can be created, so creating employment possibilities and reducing rural poverty.

## **PROBLEM STATEMENT**

The stated issues that Pulau Suri has been explained in this section. The floating markets in Pantai Suri, which are close to the water, could be impacted by increasing sea levels, tsunamis, flash floods, and monsoon floods. This is because the study that we have collected on roads for the transport of goods is missing. Roads are very important to deliver goods or bringing tourists who are unable to walk to make it easier for tourists to move here and there like the elderly. Therefore, the party in charge must take this matter seriously so that more tourists come to this Pulau Suri. Pulau Suri has difficulty with the availability of clean water. Another issue with this is that when visitors use the restroom, the water is slow and murky. As a result, it is imperative that this issue is properly resolved because tourists and vendors alike depend heavily on the use of water.

## **RESEARCH HYPOTHESIS**

The research's hypothesis is based on the study's elements, including economic, environmental, cultural, and community factors that influence the choice of domestic tourism destinations. The hypothesis had been developed and was going to be evaluated based on the investigation.

H1: There is no relationship between economic impact and Quality of life in local community of Pulau Suri in Kelantan.

H2: There is no relationship between social impact and Quality of life in local community of Pulau Suri in Kelantan.

H3: There is no relationship between environmental impact and Quality of life in local community of Pulau Suri in Kelantan.



## Research Framework

The research framework used for this study is displayed in figure 1 below.

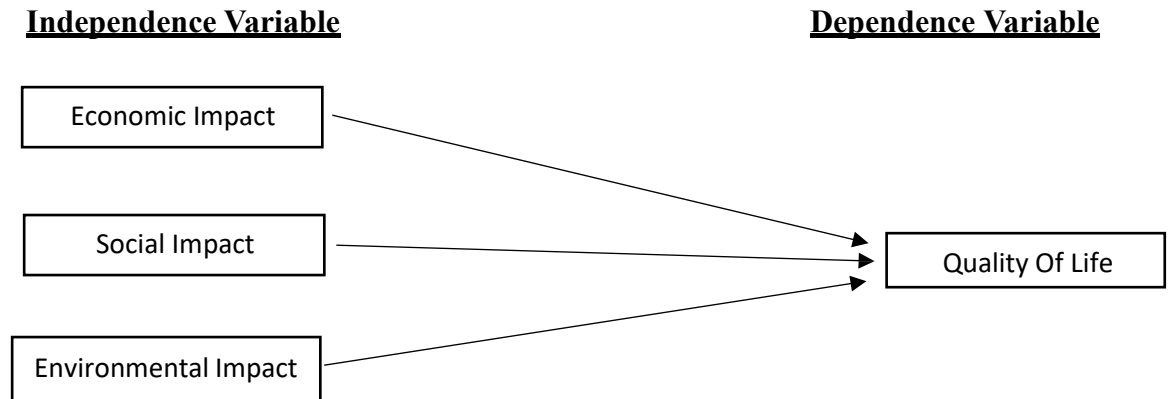

Figure 1 : Research Framework

## METHODOLOGY

Research methodology refers to the methods or tactics used to locate, pick, analyse, and evaluate data regarding a topic. A research paper's methodology section enables the reader to unbiasedly assess the study's overall validity and trustworthiness. Research methodology discusses and explains the methods you used for data collection and analysis in your study. Any thesis, dissertation, or research paper should have a methodology chapter that outlines what you did and how you did it, allowing readers to assess the reliability and validity of your research and dissertation topic.

## RESEARCH DESIGN

In order to get all the information required to conduct this research, we used the survey approach with online questions via Google Form to collect the data. Additionally, because it is standardized, this method of investigation is typically less expensive and simpler to administer than alternative ones. Researchers used this method to obtain data and information because it is an effective way to do so and because this study included a high number of respondents (Paduka, 2017). A research instrument is a device that has been scientifically and methodically created and is used to gather, measure, and analyze information on the research interests and

alignment (s). When conducting a study, researchers typically have to choose between a quantitative, qualitative, or mixed-method approach. The various types of instruments that can be used include surveys, tests, questionnaires, achievement/aptitude tests, interviews, scales (measuring and weighing tapes), archival documents and government sources, oral histories, focus group discussions and experiments, observation forms, tally sheets, and others. There are benefits and drawbacks to every instrument. The questionnaire is the most common method for obtaining research data from study participants (Abuya, 2016).

### **DATA COLLECTION**

Data collection is a process that involves acquiring and meticulously quantifying data on variables of interest in order to answer research questions, test hypotheses, and assess results. For the purpose of gathering information for this study, a total of 160 respondents were surveyed, and respondents were chosen via convenience sampling. Many diverse fields of study, such as the natural and social sciences, humanities, business, and others, use data collection. The need for exact and reliable data collecting stays the same, even while methods vary depending on the constraints (Kapur, 2018). Any attempt to collect data should be made to collect high-quality data that can be utilised to produce thorough data analysis and develop compelling cases for the issues being addressed.

### **SAMPLING**

The process of selecting a subset of the intended audience for a research study is called sampling. Smaller groups are used to collect data because it is often impractical for the entire population of interest to participate in research projects. Sampling from the population is frequently more realistic than attempting to contact every person in the community and makes it possible to collect data more quickly and affordably. So, in order to cover a big number of surveys swiftly and affordably, the researcher employed convenience sampling, which is perhaps the most popular sampling technique, to carry out this study. The sample is chosen because the researcher has access to it, which necessitates choosing any available sample of respondents that is appropriate for the researcher.

## FINDINGS

### Result of Frequency Analysis

Male respondents made up 81 of the total respondents, while female respondents made up 79. Male respondents made up 51% of the 160 total respondents, while female respondents made up the remaining 49%. There were 160 respondents overall, with ages ranging from 20 and under (21 respondents), 21–30 (37 respondents), 31–40 (62 respondents), 41–50 (21 respondents), and 51–60 (19 respondents). The respondents who ranged in age from 31 to 40 made up the largest group of respondents (38%). As for the interviewees, the bulk (91.9%) of them reported being single, while only 8.1% were married. Regarding occupation, the majority of respondents—29.4% (47 respondents)—came from the private sector, followed by housewives—26.3% (42 respondents). The second highest occupation was from the government, with a percentage of 20.6% (33 respondents), followed by fishermen with a percentage of 11.3% (18 respondents), construction workers with a percentage of 6.9% (11 respondents), shopkeepers with a percentage of 3.1% (5 respondents), and others with a percentage of 2.5% (4 respondents).

Characteristic	Frequency	Percentage (%)
<b>Gender</b>		
Male	81	51
Female	79	49
<b>Age</b>		
20 and below	21	13
21 – 30	37	23
31 – 40	62	38
41 – 50	21	13
51 – 60	19	12
<b>Race</b>		
Malay	103	64.4
Chinese	50	31.3
Indian	7	4.4
<b>Marital Status</b>		
Single	70	91.9
Married	90	8.1

<b>Occupation</b>		
Government	33	20.6
Private Sector	47	29.4
Housewife	42	26.3
Construction Worker	11	6.9
Retailers	5	3.1
Fisherman	18	11.3
Others	4	2.5

### **Result of Descriptive Analysis**

In Table 2, the variable's mean score and standard deviation are displayed. When the mean score is between 1.00 and 1.99, the factors are regarded low; when it ranges between 2.00 and 4.00, they are deemed high. Results of a descriptive analysis are shown in Table 2:

<b>VARIABLES</b>	<b>ITEMS</b>	<b>MEAN</b>	<b>STANDART DEVIATION</b>
<b>Economic Impact</b>	1. Tourism activities had increase the economic income in Pulau Suri	4.15	0.616
	2. Tourism development in Pulau Suri helps in supporting local products.	4.26	0.482
	3. Tourism development in Pulau Suri had create many job opportunities towards local community	4.37	0.486
	4. The tourism development in Pulau Suri had encourage the entrepreneurial activities in local community	4.47	0.525
	5. The development of tourism has promoted economic benefits in Pulau Suri.	4.59	0.530
<b>Social Impact</b>	1. The development of tourism in Pulau Suri made it easier for the people there to get along with outsiders	4.56	0.698

	2. The development on Pulau Suri also helped increase the mastery of foreign languages among the local community	4.54	0.768
	3. The presence of tourists on Pulau Suri can improve the communication skills of local residents with foreign tourists	4.54	0.633
	4. The development of tourism in Pulau Suri can reduce the unemployment rate among the population	4.52	0.644
	5. The development of tourism in Pulau Suri can help local people to maintain and practice their cultural	4.61	0.572
<b>Environmental Impact</b>	1. Tourism development at Pulau Suri impacted homestay accommodations	4.59	0.553
	2. Tourism development provides a good function to help the development of the surrounding population.	4.44	0.522
	3. Tourism development at Pulau Suri improves local infrastructure and communication facilities	4.49	0.593
	4. Tourism development at Pulau Suri improves the environment	4.88	3.234
	5. Tourism development activities had create people's awareness to take care of the environment	4.57	0.509
<b>Quality of Life</b>	1. The development of tourism in Pulau Suri has improved the quality of life of the local community	4.57	0.545
	2. The local community has been greatly exposed to today's advanced technology	4.58	0.508
	3. The local community has gained a lot of experience in tourism activities	4.60	0.491

	4. The development of tourism in Pulau Suri has improved the standard of living among local community in Pulau Suri	4.69	0.465
	5. The community can promote sales revenue to tourists to boost their economy if development is upgraded on Pulau Suri	4.57	0.497

### **Pearson Correlation Analysis**

One of the crucial analyses that determined the linear relationship between the two variables was the Pearson's correlation study. This analysis's goal was to find any relationships between the independent variables (economic, social, and environmental impact) and the dependent variable (life quality). Researchers must assess whether the association's strength is acceptable if the relationship is substantial.

Table 3 shows a significant relationship between independent variable and dependent variable. Based on the result, there is no significant between the independent and dependent variables. Therefore, the following hypothesis is not accepted:

### Correlations

		DV	EC	SOC	ENV
DV	Pearson Correlation	1	.051	.104	.190*
	Sig. (2-tailed)		.523	.193	.016
	N	160	160	160	160
EC	Pearson Correlation	.051	1	-.021	.096
	Sig. (2-tailed)	.523		.787	.229
	N	160	160	160	160
SOC	Pearson Correlation	.104	-.021	1	.081
	Sig. (2-tailed)	.193	.787		.309
	N	160	160	160	160
ENV	Pearson Correlation	.190*	.096	.081	1
	Sig. (2-tailed)	.016	.229	.309	
	N	160	160	160	160

\*. Correlation is significant at the 0.05 level (2-tailed).

### DATA ANALYSIS

Frequency analysis, descriptive analysis, reliability testing, and Pearson correlation analysis were the four methods of data analysis used in this study. To demonstrate the link between the dependent variable and the independent factors, the data was examined using SPSS version 26. The statistics generated by SPSS include valid percentage and cumulative percentage. Tables, charts, and graphs will be used to illustrate how the data will be presented.

## **DISCUSSION AND RECOMMENDATION**

The limitation of the study is the methodology that affects or influences the interpretation of the findings of this study. The researchers had a rewarding experience completing this full study. However, there are some constraints that cannot be ignored in order for the research process to run well.

The researcher's difficulty in swiftly locating respondents is a significant barrier to generalizing these findings. Some villages choose not to respond to their questionnaires. As a result, the researcher repeatedly asked the villagers to complete and respond to new questionnaires.

In addition, the findings contain errors in the information that the respondents submitted. Some of the respondents did not fully commit to performing this study, even if they did not complete the entire questionnaire supplied by the researchers. As a result, it was challenging for researchers to compile their findings.

Finally, this study has several limitations. In this study, third-year Wellness students at Universiti Malaysia Kelantan with three independent variables of economic impact, social impact, and environmental impact, and one dependent variable which is quality of life is the main subject in the study conducted by the researcher.

## **RECOMMENDATION**

Tourism is crucial for women's economic empowerment and contributes to infrastructural development, which in turn benefits other sectors of the economy. There is also enormous potential to green and sustainable the sector, so contributing to environmental conservation. Pulau Suri, which possesses a diverse range of tourism resources, should be promoted as a new tourist destination. However, concerted cooperative efforts are essential to revitalise the sector and overcome the post-COVID-19 consequences caused by an almost two-year lockdown.

Our marketing methods, as well as how and where we advertise, are critical to capturing the attention of potential tourists. By focusing our marketing campaigns on the fascinating aspects of our location, we will quickly capture the interest of international travellers. We will notice that each marketing campaign highlights well-known tours, events, and sites from the



country in question. They've managed to collect everything that excites tourists and market it through their ads.

Finding the ideal outlets to promote your marketing strategy is also critical to ensuring that you reach the right audience. For example, if you want to reach a largely younger clientele, online marketing is the way to go. However, collaborating with local travel agencies or promoting through print media channels may be a better fit if you're selling to an older audience.

## **CONCLUSION**

In conclusion, the research on the impact of tourism development in Pulau Suri Kelantan on the quality of life in the local community reveals a complex interplay of positive and negative effects. While tourism has brought economic benefits and improved access to amenities and services, it has also led to environmental strain, social changes, and challenges to cultural identity. To ensure a sustainable and inclusive tourism model, it is essential for policymakers and stakeholders to prioritize environmental protection, community involvement, and equitable distribution of benefits. By striking a balance between economic growth and the preservation of cultural and natural heritage, Pulau Suri Kelantan can aspire to a tourism industry that enhances the overall well-being and quality of life for its residents.

## REFERENCES

- Akter, M., Sadekin, M. N., & Patwary, A. K. (2020). An Empirical Study on Students' Satisfaction from Mawlana Bhashani Science & Technology University, Bangladesh. *Review of Economics and Development Studies*, 6(2), 363-379.
- Alom, S., Patwary, A. K., & Khan, M. M. H. (2019). Factors affecting the turnover intention of Bangladeshi migrants in the United Arab Emirates: An empirical study on the hotel industry. *International Journal of Innovation, Creativity and Change*, 8(3), 344-360.
- Amir, A. F., Ghapar, A. A., Jamal, S. A., & Ahmad, K. N. (2015). Sustainable Tourism Development: A Study on Community Resilience for Rural Tourism in Malaysia. *Procedia - Social and Behavioral Sciences*, 168, 116-122. <https://doi.org/https://doi.org/10.1016/j.sbspro.2014.10.217>
- Blegur, J., Rajagukguk, C. P. M., & Rosari, R. (2022). Empowering a supportive physical education learning culture for the development of students' social self-esteem. *Facta Universitatis: Series Physical Education and Sport*, 20(1), 25-34. <https://doi.org/10.22190/FUPES201111003B>
- Boru, T. (2018). *CHAPTER FIVE RESEARCH DESIGN AND METHODOLOGY 5.1*.
- Fengmin, Z., Baijun, W., Jiangtao, B., Li, L., & Patwary, A. K. (2022). Investigating revisit intention of medical tourists in China through nutritional knowledge, perceived medical quality, and trust in the physiologist: A recommendation on health tourism policy measures. *Frontiers in Public Health*, 10, 893497.
- Field, D. (1997). *Marketing for leisure and tourism*. Hodder & Stoughton Ltd.
- Galdini, R. (2007). Tourism and the city: opportunity for regeneration. *Tourismos*, 2(2), 95-111.
- González-Herrera, M. R., & Giralt-Escobar, S. (2021). Tourism experiential learning through academic field trips in higher education: a case study of copper canyon (Mexico).
- Hassan, T. H., Salem, A. E., & Abdelmoaty, M. A. (2022). Impact of rural tourism development on residents' satisfaction with the local environment, socio-economy and quality of life in Al-Ahsa region, Saudi Arabia. *International Journal of Environmental Research and Public Health*, 19(7). <https://doi.org/10.3390/ijerph19074410>
- Hazbar, A. M. H., Alem Mohammed, A., & Karim, A. K. A. (2019). An Empirical Study of Factors Influencing hotel customers' online booking Intention. *مجلة العلوم التربوية و الدراسات الإنسانية*, (5), 1-17.
- Introduction Citation: Lelissa TB (2018); Research Methodology; University of South Africa, PHD Thesis. <https://doi.org/10.13140/RG.2.2.21467.62242>*
- Işildar, P. (2022). Corporate identity structure in hotels: an exploratory study. *International Journal of Contemporary Tourism Research*, 6(1), 20-39. <https://doi.org/10.30625/ijctr.1118180>
- Iştin, A. E. (2021). The relationship between the tourism impacts and the quality of life in the city. *Journal of Hospitality and Tourism Issues (JOHTI)*, 3(2), 176-196. <https://doi.org/10.51525/johti.1037378>
- Li, L., Ragavan, N. A., Patwary, A. K., & Baijun, W. (2022). Measuring patients' satisfaction toward health tourism in Malaysia through hospital environment, nutritional advice, and perceived value: A study on Chinese exchange students. *Frontiers in public health*, 10, 893439.

- Li, L., Wu, B., & Patwary, A. K. (2022). How marine tourism promote financial development in sustainable economy: new evidences from South Asia and implications to future tourism students. *Environmental Science and Pollution Research*, 29, 1155-1172.
- Li, L., Wu, B., & Patwary, A. K. (2022). The psychosocial factors affecting chinese Outbound Exchange and mobility students' academic performance during COVID-19. *Frontiers in psychology*, 13, 872516.
- Lo, Y.-C., & Janta, P. (2020). Resident's Perspective on Developing Community-Based Tourism – A Qualitative Study of Muen Ngoen Kong Community, Chiang Mai, Thailand [Original Research]. *Frontiers in Psychology*, 11. <https://doi.org/10.3389/fpsyg.2020.01493>
- Malai, V., & Speece, M. (2005). Cultural Impact on the Relationship Among Perceived Service Quality, Brand Name Value, and Customer Loyalty. *Journal of International Consumer Marketing*, 17(4), 7-39. [https://doi.org/10.1300/J046v17n04\\_02](https://doi.org/10.1300/J046v17n04_02)
- Morgan, R. K. (2012). Environmental impact assessment: the state of the art. *Impact Assessment and Project Appraisal*, 30(1), 5-14. <https://doi.org/10.1080/14615517.2012.661557>
- Morris, C. (1964). Signification and Significance a Study of the Relations of Signs and Values.
- Patwary, A. K., Roy, B., Hoque, R., & Khandakar, M. S. A. (2019). Process of developing a community based tourism and identifying its economic and social impacts: An Empirical study on Cox's Bazar, Bangladesh. *Pakistan Journal of Humanities and Social Sciences*, 7(1), 1-13.
- Sumethokula, P., Patwary, A. K., Srinuanpanc, B., Srinuanpand, C., Suwandee, P., Thammathikul, A., & Phanong, W. (2020). The potential of new tour repackaging for creative tourism among entrepreneurs in Nakhon Si Thammarat. *International Journal of Innovation, Creativity and Change*, 13(10), 1752-1771.
- The Kelantan Delta: Pulau Suri*. (2011, October 21). The Kelantan Times. <https://muhammadismailibrahim.wordpress.com/2011/10/21/the-kelantan-delta-pulau-suri/> *Tourism (Zagreb)*, 69(4), 471-493. <https://doi.org/10.37741/t.69.4.1>
- Wu, B., Liu, S., Wang, J., Tahir, S., & Patwary, A. K. (2021). Assessing the mechanism of energy efficiency and energy poverty alleviation based on environmental regulation policy measures. *Environmental Science and Pollution Research*, 28, 40858-40870.
- Wu, B., Zhai, B., Mu, H., Peng, X., Wang, C., & Patwary, A. K. (2021). Evaluating an economic application of renewable generated hydrogen: A way forward for green economic performance and policy measures. *Environmental Science and Pollution Research*, 1-15.

# PERCEPTION OF KUALA TERENGGANU AS AN ISLAMIC TOURISM DESTINATION AMONG THE PEOPLE THAT HAD BEEN IN KUALA TERENGGANU

MUHAMMAD RAFIQ FAHMI ABD RAHMAN

MUHAMMAD SYAMEL AFIQ AZAHAM

MUHAMMAD SHAHRUL NIZAM ISKANDAR MD NOOR

MUHAMMAD SHAFIQ ADAM SHAMSULAZWADI

NORIZAN BT MUSA

*Faculty of Hospitality, Tourism and Wellness, University Malaysia Kelantan*

*Corresponding email: norizanmusa1@gmail.com*

## ABSTRACT

This study is about tourist perception who visit Kuala Terengganu as an Islamic tourism destination. Perception is one of the important factors considered by tourist in visiting a destination beside motivation attractiveness, spiritual experience, culture attribute, religion and accessibility. Therefore, this research is to examine the relationship between brand image and tourist perceptions of Kuala Terengganu as an Islamic Tourism destination. Second, to examine the relationship between spiritual experience and tourist perceptions of Kuala Terengganu as an Islamic tourism destination. Lastly, to examine the relationship between cultural attributes and tourist perceptions of Kuala Terengganu as an Islamic tourism destination. The quantitative method used in this research is questionnaires. About 327 respondents which is domestic and international tourists who went and experience in Kuala Terengganu chosen in this study.

**Keywords:** Tourist Perception, Islamic Tourism

## INTRODUCTION

This study examines the perception of tourists visiting Kuala Terengganu as an Islamic tourism destination. It examines the relationship between brand image, spiritual experience, culture attribute, religion, and accessibility. The research uses questionnaires to gather 327 domestic and international tourists. Kuala Terengganu is a developing city with diverse cultures, rich heritage, and friendly locals. The Terengganu State Museum, located in Kampung Losong, is one of Malaysia's largest museums. The results show that spirituality, destination branding, and cultural characteristics strongly influence tourists' perception of Kuala Terengganu. The opinions of visitors are significant as they will influence future tourists. The study highlights the importance of understanding tourists' perceptions of destinations and implementing measures to boost tourism revenues and protect tourism-related characteristics.

### Significance of the Study

Theoretically, this study has many consequences. This study uses a quantitative methodology to generalize conclusions and findings. The results of this study serve as a standard to guide Tourist Perceptions of Kuala Terengganu as an Islamic Tourism Destination. This study focuses on tourists' views. It addresses three main research questions: What are people's perspectives about Kuala Terengganu being an Islamic tourism destination? How far do people understand the history of Islam in Malaysia? What are the postulated characteristics of the Islamic tourism destination transpiring in Kuala Terengganu? Visitor satisfaction is one of the most important elements that guarantee future business growth. Today, many businesses use visitor happiness as a critical metric to measure the effectiveness of their operations. According to the tourism literature review, the destination's ability to satisfy visitors is an important consideration when choosing a location. If visitors are satisfied with their trip to the site, they may recommend it to others or return it themselves. (Site, Abbasi et al. 2019)

## **LITERATURE VALUE**

### **IV<sub>1</sub>: Brand Image**

The brand image serves as the foundation of a framework that has a variety of consequences on customer reactions to tourism industry marketing. Given the significance of brand image for the tourist sector, during the past ten years, the sector has been working to build a conceptual framework for brand image, and, from the viewpoint of the travel sector, improve a sweet impression on customers. For the travel and tourist industry, the conceptual framework recognizes both the moderators and the antecedents of brand image. In actuality, the antecedents and moderators of brand image are latent factors whose function is to establish and uphold a brand image in the minds of customers. The conceptual underpinning of the tourism industry's brand image will be crucial in this regard given the existing state of tourism marketing. One of the key elements of customer-based brand equity that supports views of a travel brand and is communicated by the brand associations ingrained in a customer's memory is the conceptual framework of brand image (Keller, 2008). As a result, it is understood that the conceptual framework of brand image for the tourism industry plays a key role. As a result, it is recognised that the conceptual framework for the tourism industry's brand image plays a significant role as antecedents and moderators of brand image, allowing the industry to remain in customers' memory for a long time.

### **IV<sub>2</sub>: Spiritual Experience**

Three new, essential components of spirituality are highlighted by a synthesis of numerous viewpoints: Conscious attention to God, the Supreme Being, or the High Spirit comes first, followed by an awareness of oneself and others (Mitroff, 2003; Piedmont and Leach, 2002). Mitroff (2003) upheld the idea that spirituality is connected to God, a High Spirit, or a Supreme Being by referring to God as the controlling force behind the universe. According to Piedmont and Leach (2002), who concur that humans have always sought to connect with some great and sacred truth, which has been a constant force in humanity, spirituality is tied to God. This reality is described as a "non-delimited formless form of the unseen" by Sufi Rumi, according to a quotation from him "(Rustom, 2008, p.4)

### **IV<sub>3</sub>: Cultural Attribute**

Learning about, exploring, experiencing, and consuming both real and intangible cultural attractions and products in a trip destination are the main goals of cultural tourism. In addition to literature, music, the creative industries, living cultures with their unique ways of life, value systems, beliefs, and traditions, arts and architecture, historical and cultural heritage, culinary heritage, arts and architecture, these attractions/products are linked to a variety of distinctive material, intellectual, spiritual, and emotional characteristics of a society.

### **DV: Kuala Terengganu as an Islamic Tourism Destination**

The phrase Islamic tourism arose from a debate at an Organization of Islamic Cooperation summit in 2000, which recommended the practice of travel inside Islamic nations to produce cash and help countries grow (Lina Munirah & Hairul Nizam, 2012; Zamani-Farahani & Henderson, 2010). However, the 9/11 tragedy in 2001 spurred the rise of secular thought connected with Islam with terrorism, leading to the establishment of Islamic tourism to overcome Islam's image crisis (Norlida Hanim et al., 2010). Since then, debates have centered on the definition of Islamic tourism. As this tourist idea should be regarded in various aspects, the clear definition of Islamic tourism is still vague, as is the outcome itself. Thus, additional discussion in this work contributes to a more specific understanding of the idea of Islamic tourism, including participants, activities, sites, goods, dimensions, value, and Islamic tourist management.

### **Research Hypothesis**

The analysis of the available literature revealed that independent factors such as brand perceptions, spiritual encounters, and cultural characteristics affected how visitors saw Kuala Terengganu as an Islamic tourist destination. As a result, the research methodology examines the relationships between the variables. Researchers assert that the antecedents and moderators of brand image components within the context of the proposed conceptual framework of brand image, spiritual experiences, and cultural attributes for the tourism industry would have a potential for developing a strong tourism brand in the contemporary environment of tourism marketing because they can offer helpful managerial implications that will aid the tourism brand managers. Thanks to many of the ideas presented in this suggested conceptual framework, the reader will have a deeper understanding of how the tourism sector may establish and sustain a brand's reputation, spiritual experiences, and cultural characteristics. According to researchers, the tourism sector will be able to forge a strong brand identity and turn consumer connections into a competitive marketplace with the support of social media. With the aid of the conceptual framework they have developed, researchers think the tourism sector will be able to create a strong brand identity and turn consumer connections into a competitive marketplace.

### **Research Framework**

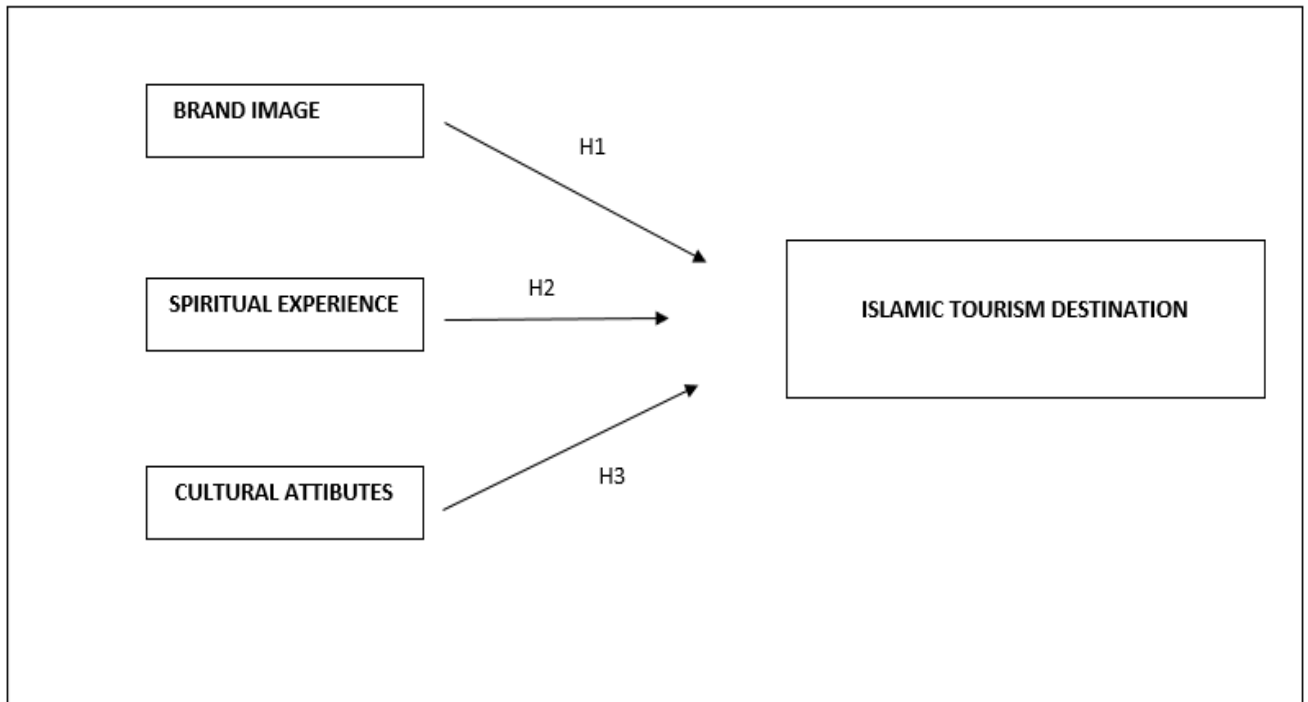

FIGURE 2.1: CONCEPTUAL FRAMEWORK INDEPENDENT VARIABLE AND DEPENDENT VARIABLE  
SOURCE

## **METHODOLOGY**

It is defined as using research information while applying something to a planned outcome. The research process, data collection techniques, sampling plan, and presented work form a large part of the analytical approach. From the above statement, it can be concluded that what conveys the definition of research is a methodical and objective effort with the aim of gathering or collecting correct and useful facts. The process of reviewing and researching studies systematically and fairly is known as methodology.

### **Research Design**

This study uses several research models to propose a conceptual model that can fully explain the perception of quality destinations in tourism satisfaction. In addition, the important thing to consider is that between gender and the frequency of visits will have an impact on the relationship and these factors.

### **Data Collection**

The research study will collect data using primary data, which is information gathered directly from sources by researchers via an online survey GOOGLE FORM. In this study, primary data was collected using

questionnaires, which were distributed to respondents. The questionnaire will be distributed via an online survey, also known as an online questionnaire. The purpose of this analysis was stated in the link included with the form that was distributed to the respondents. As a result, respondents can understand the motivation and purpose of this study, allowing them to generate more accurate data. The questionnaire was distributed to 131 respondents regarding tourist perception of Kuala Terengganu as an Islamic tourism destination.

### **Sampling**

This random sampling method refers to the collection of information to participate in research studies from members of the population (Sekaran, 2009). Therefore by using random sampling the number of people is large which will include all individuals. A random sampling method was used for sampling in this study. This study simulates the relationship between brand image, spiritual experiences, and cultural attributes and looks at the extent to which tourist perception Kuala Terengganu as an Islamic tourism destination. Since cluster sampling has been a common approach in market research, this type of sampling can save a lot of time, money, and effort. It is used when researchers cannot obtain information about the entire population but can gain information about specific clusters.

### **Data Analysis**

This study simulated the factor affecting tourist perception while traveling in Kuala Terengganu or tourists that have an experience in Kuala Terengganu. The findings revealed that brand image, spiritual experiences, and cultural attributes factor influenced tourist perception of Kuala Terengganu as an Islamic tourism destination.



## FINDINGS

### *Demographic Analysis*

*This item measuring the chosen research constructs were adopted from prior related research in the field of tourist that had been in Kuala Terengganu.*

Table 1: Measurement Items

Measurements	Number of Items in the Questionnaire	Scales Used
Section A: Demographic Information	7	Adapt
Section B: Perception of Kuala Terengganu as an Islamic Tourism Destination (DV)	5	Adopt
Section C: Relationship between Brand Image and Perception of Kuala Terengganu as an Islamic Tourism Destination (IV <sub>1</sub> )	4	Adopt
Section D: Relationship between Spiritual Experience and Perception of Kuala Terengganu as an Islamic Tourism Destination (IV <sub>2</sub> )	4	Adopt
Section E: Relationship between Cultural Attribute and Kuala Terengganu as an Islamic Tourism Destination (IV <sub>3</sub> )	3	Adopt

Table 2: Demographic Profile of Scale

Characteristic	Frequency	Percentage (%)
Gender	Female	42
	Male	58
Age	18-23 years old	73.3
	21-25 years old	0.8
	24-29 years old	19.1
	30-35 years old	3.8
	36-40 years old	2.3
	41 years old and above	0.8
Race	Chinese	3.8
	Indian	2.3
	Malay	93.1
	Siamese	0.8
Level of Education	Diploma	13.7
	Degree	74.8
	Master	0.8
	SPM	9.2
	No Education	1.5
Occupation	Government Staff	2.3
	Private Sector Staff	10.7
	Self-employed	5.3
	Student	78.6
	Unemployed	3.1
Income	No Income	77.1
	RM1001-RM1500	4.6
	RM1501-RM2000	4.6
	RM2001-RM2500	2.3
	RM2501-RM3000	1.5
	RM3001 and above	3.8
Status	Single	92.4
	Married	7.6

Table 2 presents an overview of the responder profile. A total of 55 female respondents, compared to 76 male respondents, completed the survey. The age group from 18 to 23 years old had the highest percentage of respondents (73.3%), followed by the age group from 24 to 29 years old (19.1%), the age group from 30 to 35 years old (2.3%), and last but not least, the age groups from 21 to 25 years old and 41 years and over (0.8%).

There were 120 respondents who answered the questionnaires, including 122 Malay respondents, 3 Indian respondents, 5 Chinese respondents, and 1 Siamese respondent. Malay respondents made up the majority with 93.1%, followed by Chinese respondents with 5%, Indian respondents with 3%, and Siamese respondents with 0.8%.

The degree of education is next. Degrees account for the responder population's greatest level of education (74.8%). With 13.7%, Diploma comes in second. SPM comes in second with 9.2%, and No Education is third with 1.5%. Master comes in last but not least with 0.8%.

The occupation is next. Students made up the response group with the highest percentage (78.6%). The private sector workforce has the second-highest share with 10.7%. Self-employed people come in third with 5.3%, followed by the jobless with 3.1%. Government employees had the lowest number among the respondents (2.3%).

Then comes the respondents' income. With a percentage of 77.1%, those with no income have the highest percentage of income. The next greatest percentage, 4.6%, is found in the range of RM1001 to RM1500 and RM1501 to RM2000. The following percentage is 2.3% for RM2001 to RM2500. The lowest percentage of income, or 1.5%, is between RM2501 and RM3000.

The status of the respondents is not the least important. The percentage of respondents who are single is the largest (92.4%), followed by the percentage who are married (7.6%).

### **Descriptive Analysis**

This study has analyzed the mean and standard deviation for section B, C, D, and E of the questionnaire

Table 3: Descriptive Statistic

Variable	Average of N	Average of Mean	Average of Standard Deviation
Perceptive of Kuala Terengganu as an Islamic Tourism Destination	130	1.7	0.864
Brand Image	128	1.61	0.801
Spiritual Experience	124	1.60	0.794
Cultural Attribute	128	1.7	0.810

Table 3 shows the mean and standard deviation analysis for the independent and dependent variables. The perception of Kuala Terengganu as an Islamic tourist destination is the dependent variable in this study, whereas brand image, spiritual experience, and cultural attributes are the independent variables. The component where respondents agreed more with each other, with a higher mean value of 1.7, was respondents' perception of Kuala Terengganu as an Islamic tourist destination and cultural attributes. The respondents in this survey agreed that Spiritual Experience had the lowest Mean Value for that measure, which is only 1.6. The data set that has more dispensing values has a Standard Deviation of more than 1 out of 120 respondents.

### **Reliability Test**

A reliability test is used to assess a systems overall stability and performance over a particular period under various testing situations. The pilot test was conducted with 120 people via internet survey.

Table 4: Result of Reliability Test

Variable	Number of Items	Cronbach's Alpha Coefficient	Strength of Association
Perception of Kuala Terengganu as an Islamic Tourism Destination	5	0.713	Good
Brand Image	5	0.773	Good
Spiritual Experience	4	0.441	Poor
Cultural Attribute	4	0.633	Moderate

Table 4 displays the independent and dependent variables' Cronbach's Alpha Coefficient values. The table above shows that the majority of the variables were more than 0.6. As a result, the drawn conclusion can be trusted and used in this investigation. Five questions were used to gauge how persons who had visited Kuala Terengganu perceived it as an Islamic tourist destination; the Cronbach's Alpha result for this section question was 0.713, which is good. As a result, the coefficients calculated for these questions in assessing how persons who had visited Kuala Terengganu perceived it as an Islamic tourist destination were also trustworthy. Since variables exceeded the Cronbach's Alpha charge, it can be inferred that surveys are very reliable and that the study can move on.

Five questions were used to measure the Brand Image variable, which affected how people who had visited Kuala Terengganu perceived it as an Islamic tourist destination. The Cronbach's Alpha result for these questions was 0.773, which was favorable. The computed coefficients for the Brand Image variable questions were therefore accurate.

As a result of the four questions used to assess how Spiritual Experience affected people's perceptions of Kuala Terengganu as an Islamic tourist destination, the result was a poor 0.441, which is regarded as inadequate. The coefficient calculated for the Spiritual Experience variable was unreliable as a result.

Finally, four questions were used to evaluate the Cultural Attributes variable, which affected how people who had visited Kuala Terengganu perceived it as an Islamic tourist destination. The result was 0.633, which is regarded as moderate. The coefficient estimated for the Cultural Attributes variable was accurate as a consequence.

### **Pearson Correlation Analysis**

One of the most important analyses that examined the linear relationship between the two variables was the Pearson Correlation Analysis. The goal of this study was to ascertain whether Kuala Terengganu's perception as an Islamic tourism destination and the independent variables of brand image, spiritual experience, and cultural characteristics were correlated in any way. If the relationship is significant, the researchers must determine what degree of connection strength is acceptable.

### **Hypothesis 1**

H<sub>1</sub>: There is relationship between Brand Image and Kuala Terengganu as an Islamic Tourism Destination among people that had been in Kuala Terengganu.

Table 5: Correlation Coefficient for Brand Image and Kuala Terengganu as an Islamic Tourism Destination among the people that had been in Kuala Terengganu

		IV <sub>1</sub>	DV
IV <sub>1</sub>	Pearson Correlation	1	0.926**
	Sig. (2-tailed)		0.000
	N	131	131
DV	Pearson Correlation	0.926**	1
	Sig. (2-tailed)	0.000	
	N	131	131

\*\*Correlation is significant at the 0.01 level (2-tailed)

### Hypothesis 2

H<sub>2</sub>: There is significant relationship between Spiritual Experience and Kuala Terengganu as an Islamic Tourism Destination among people that had been in Kuala Terengganu

Table 6: Correlation Coefficient for Spiritual Experience and Kuala Terengganu as an Islamic Tourism Destination among the people that had been in Kuala Terengganu

		IV <sub>2</sub>	DV
IV <sub>2</sub>	Pearson Correlation	1	0.376**
	Sig (2-tailed)		0.000
	N	131	131
DV	Pearson Correlation	0.376**	1
	Sig. (2-tailed)	0.000	
	N	131	131

\*\*Correlation is significant at the 0.01 level (2-tailed)

### Hypothesis 3

H<sub>3</sub>: There is significant relationship between Cultural Attributes and Kuala Terengganu as an Islamic Tourism Destination among people that had been in Kuala Terengganu

Table 7: Correlation Coefficient for Cultural Attribute and Kuala Terengganu as an Islamic Tourism Destination among the people that had been in Kuala Terengganu

		IV <sub>3</sub>	DV
IV <sub>3</sub>	Pearson Correlation	1	0.135
	Sig. (2-tailed)		0.126

	N	130	130
DV	Pearson Correlation	0.130	1
	Sig. (2-tailed)	0.126	
	N	130	131

To ascertain the linear relationship between the two variables that were designated as the study's purpose, researchers employed correlation analysis. The correlation analysis's findings, which are presented in Table 8, demonstrate a substantial correlation between brand image, spiritual experience, and cultural attributes. Additionally, among those who have visited Kuala Terengganu, there is a significant correlation between Brand Image, Spiritual Experience, and Cultural Attributes.

## Discussion & Recommendation

The study examined the connections between Kuala Terengganu's brand image, spiritual experience, cultural characteristics, and perception of it as an Islamic tourist destination. This study's goal is to ascertain the relationship between brand image, spiritual experience, cultural characteristics, and visitors' perceptions of Kuala Terengganu as an Islamic tourist destination.

This study only takes into account the three factors—brand image, spiritual experience, and cultural attributes—that affect how people who have visited Kuala Terengganu see it as an Islamic tourist destination. However, it's possible that this study is ignoring other significant factors that have an impact on how visitors to Kuala Terengganu perceive it as an Islamic tourist destination. As a result, future researchers might suggest adding more variables.

The target population of this study may be determined using the 120 samples that were used. Higher sample sizes might be used to analyze millions of Malaysians if the amount is sufficiently dependable. Consequently, future researchers should increase their sample size in order to enhance the validity and reliability of their studies.

Future studies should be conducted to stay current on factors that could affect how Kuala Terengganu is perceived as an Islamic tourist destination with a distinctive brand, spiritual experience, and cultural characteristics. It is possible to evaluate the elements that affect people's perceptions of Kuala Terengganu as an Islamic tourist destination, which could help company owners employ more effective marketing strategies. In the future, academics might develop a special framework for assessing how people who have visited Kuala Terengganu with the tourism business perceive the region as an Islamic tourist destination. Regional surveys must be done to determine how positively people perceive Kuala Terengganu as an Islamic tourist destination because people's perceptions are diverse.

Instead of asking respondents to fill out a scaled online survey questionnaire, an interview method is used to create open-ended questions for them. Interviews may yield a high response rate for researchers, allowing them to immediately explore any uncertainties or partial answers. Thus, these strategies will do away with misinterpretation and greatly enhance research outcomes.

## CONCLUSION

In conclusion, the purpose of this study was to investigate how visitors to Kuala Terengganu saw it as an Islamic tourism destination. Brand image, spiritual experience, and cultural characteristics are the

influencing factors (independent variables), and Islamic tourist destinations among domestic and international visitors to Kuala Terengganu are the dependent variables. As mentioned in Chapter 3, the researcher employed a Google Form with 131 respondents who travelled to and visited Kuala Terengganu to receive the questionnaire's responses. Additionally, the researcher only uses quantitative techniques to gather data and information. Additionally, the researcher reached respondents across Malaysia by using Google Forms as a platform. This is so that respondents can more easily complete all of the surveys by utilizing this Google form. Additionally, it can enable researchers to cut expenses and time.

The outcomes of the questionnaire survey were examined using a variety of techniques, including frequency analysis, descriptive analysis, reliability analysis, and correlation analysis. The results from the preceding chapter as well as all of the data from the questionnaire were then examined using the Statistical Package for the Social Science (SPSS) software application. The researchers choose this program because it makes it easy to access all the findings. Finally, depending on the data analysis, a summary and recommendation. For this investigation, all of the stated hypotheses (H1, H2, H3, and H4) are accepted. Additionally, there are certain restrictions and suggestions that could be used to future research in this study.

## REFERENCES

Buyong, A. (1982). Sejarah Terengganu. 1st ed. Kuala Lumpur: Dewan Bahasa dan Pustaka.

ECER (2010). Kuala Terengganu City Centre: A Vibrant Heritage Waterfront City. East Coast Economic Region Development Council (ECERDC).

Ezrin, A. (1986). Petempatan serta Bandar-bandar Awal di Tanah Semenanjung. Bulletin of Faculty of Built Environment. Universiti Teknologi Malaysia (Unpublished).

Jabatan Perancangan Bandar dan Wilayah Semenanjung Malaysia (2009). Morfologi Bandar Kuala Terengganu. Kuala Terengganu: Kementerian Perumahan dan Kerajaan Tempatan.

Kuala Terengganu City Council (2016). Kuala Terengganu Info. [Online] Official Portal of Kuala Terengganu City Council (MBKT). Available at:  
<http://mbkt.terengganu.gov.my/en/visitors/kuala-terengganu-info> [Accessed 5 Feb. 2017].

Shuhana, S. (2011). Townscape Revisited: Unravelling the Character of the Historic Townscape in Malaysia. Johor Bahru: Penerbit UTM Press.

Shuhana, S. and Ahmad Bashri, S. (1992). Typology of urban form of old town centres in Malaysia. Johor Bahru: Universiti Teknologi Malaysia.

Shuhana, S., Abdul Latip, N. and Ahmad Basri, S. (2008). Waterfront Regeneration as a Sustainable Approach to City Development in Malaysia. *The Sustainable City V*, [online] 117, pp.45 - 54. Available at: <https://www.witpress.com/elibrary/wit-transactions-on-ecology-and-theenvironment/117/19695> [Accessed 11 Jun. 2017].

Shuhana, S., Nurul Syala, A. and Ahmad Bashri, A. (2013). Regenerating the Historic Waterfront: An Urban Design Compendium for Malaysian Waterfront Cities. 1st ed. Kuala Lumpur: Institut Terjemahan & Buku Malaysia.

Siti Norlizaiha, H. and Rusamah, A. (2012). The Morphological History of the Malaysian Urban Form. *IPEDR*, 48(24).

Tung, A. (2001). *Preserving the World's Great Cities: The Destruction and Renewal of the Historic Metropolis*. 1st Ed. New York: Random House International.

United Nations Educational, Scientific and Cultural Organization (2013). *World Heritage Resource Manual. Managing Cultural World Heritage*. [Online] Paris: UNESCO. Available at: <http://file:///C:/Users/USER/Downloads/activity-827-1.pdf> [Accessed 11 Jun. 2017].

World Monuments Fund (1992). *Trails to Tropical Treasures A Tour of ASEAN's Cultural Heritage*. 1st ed. ICOMOS.

Zainal Abidin, N.A and Lee, G. (2011). Methodology for Evaluating the Landscape Character of Malaysian Heritage Urban River Corridors. In *eddB2011*, 27 - 29 April 2011, Queensland University of Technology, Brisbane, Qld.



Zul Azri, A., Dilshan, R. and Syed Zainol Abidin, I. (2010). The Islamic Malay traditional towns, learning through the attributes special emphasis on Johor Bahru, Malaysia. In: International Conference for Urban & Architecture Heritage in Islamic Countries. Riyadh: Unpublished.

Adelman, M., A. Ahuvia, and C. Goodwin (1994). "Beyond Smiling: Social Support and Service Quality." In *Service Quality: New Directions in Theory and Practice*, edited by R. T. Rust and R. L. Oliver. Thousand Oaks, CA: Sage, pp. 139-171.

Armstrong, R., C. Mok, F. Go, and A. Chan (1997). "The Importance of Cross-cultural Expectations in the Measurement of Service Quality Perceptions in the Hotel Industry." *International Journal of Hospitality Management*, 16 (2): 181-190.

Bove, L. L., and L. W. Johnson (2000). "A Customer-service Worker Relationship Model." *International Journal of Service Industry Management*, 11 (5): 491-511.

Coyle, M. P., and B. G. Dale (1993). "Quality in the Hospitality Industry: A Study." *International Journal Hospitality Management*, 12 (2): 141-153.

Furrer, O., B. S. C. Liu, and D. Sudharshan (2000). "The Relationships Between Culture and Service Quality Perceptions Basis for Cross Cultural Market Segmentation and Resource Allocation." *Journal of Service Research*, 2 (4): 355-371.

Hartline, M. D., J. G. Maxham III, and D. O. McKee (2000). "Corridors of Influence in the Dissemination of Customer-oriented Strategy to Customer Contact Service Employees." *Journal of Marketing*, 64: 35-50.

Hofstede, G. (1980). *Culture Consequences: International Difference in Work-Related Values*. Beverly Hills, CA: Sage.

Hofstede, G. (1983). "Motivation, Leadership, and Organization: Do American Theories Apply Abroad?" *Organizational Dynamics*, 11: 42-63.

Hofstede, G. (1997). *Cultures and Organizations: Software of the Mind*. London: McGraw-Hill.

Kim, S., B. Prideaux, and S. Kim (2002). "A Cross-Cultural Study on Casino Guests as Perceived by Casino Employees." *Tourism Management*, 23 (5): 511-520.

King, C. (1985). "Service Quality Assurance is Different." *Quality Progress*, 20 (9): 27-23.

King, C., and J. Garey (1997). "Relational Quality in Service Encounters." *International Journal of Hospitality Management*, 16 (1): 39-63.

Luk, S., C. Leon, F. Leong, and E. Li (1993). "Value Segmentation of Tourists' Expectations of Service Quality." *Journal of Travel & Tourism Marketing*, 2 (4): 23-38.

Malhotra, N., F. Ugaldo, J. Agarwal, and I. Baalbaki (1994). "International Services Marketing: A Comparative Evaluation of the Dimensions of Service Quality in Developed and Developing Countries." *International Marketing Review*, 11 (2): 5-15.

Martin, R., and D. Lundberg (1991). *Human Relations for the Hospitality Industry*. New York: Van Nostrand Reinhold.

Mattila, A. (1999). "The Role of Culture and Purchase Motivation in Service Encounter Evaluations." *Journal of Service Management*, 13 (4/5): 376-389.

Parasuraman, A., V. A. Zeithaml, and L. L. Berry (1985). "A Conceptual Model of Service Quality and Its Implication for Future Research." *Journal of Marketing*, 49 (fall): 41-50.

Parasuraman, A., V. A. Zeithaml, and L. L. Berry (1988). "SERVQUAL: A Multiple-item Scale for Measuring Consumer Perceptions of Service Quality." *Journal of Retailing*, 64 (1): 12-40.

Parasuraman, A., V. A. Zeithaml, and L. L. Berry (1991). "Understanding Customer Expectation of Service." *Sloan Management Review*, 32 (3): 39-48.

Reisinger, Y., and L. Turner (1998). "Cultural Differences Between Mandarin-Speaking Tourists and Australian Hosts and their Impact on Cross-Cultural Tourists-Host Interaction." *Journal of Travel and Tourism Marketing*, 7 (4): 79-106.

Reisinger, Y., and L. Turner (2003). *Cross-Cultural Behaviour in Tourism: Concepts and Analysis*. Oxford, UK: Butterworth-Heinemann.

Riddle, D. (1992). "Leveraging Cultural Factors in International Service Delivery." *Advances in Services Marketing and Management*, 1: 297-322.

Ridley, S. (1995). "Towards a New Business Culture for Tourism and Hospitality Organizations." *International Journal of Contemporary Hospitality Management*, 7 (7): 36-43.

*Terengganu rich in Islamic tourism sites*. (2020, October 21). The Star.  
<https://www.thestar.com.my/news/nation/2020/10/21/terengganu-rich-in-islamic-tourism-sites>

Nawi, N. C., Mamun, A. A., Nasir, N. A. M., Abdullah, A., & Mustapha, W. A. W. (2019, September 2). *Brand image and consumer satisfaction towards Islamic travel packages*. Asia Pacific Journal of Innovation and Entrepreneurship; Emerald Publishing Limited. <https://doi.org/10.1108/apjie-02-2019-0007>

Amin, J. M. (2014, May 25). *CULTURAL LANDSCAPE OF TRADITIONAL HOUSE COMPOUNDS IN TERENGGANU*. [www.academia.edu](http://www.academia.edu).  
[https://www.academia.edu/5095660/CULTURAL\\_LANDSCAPE\\_OF\\_TRADITIONAL\\_HOUSE\\_COMPOUNDS\\_IN\\_TERENGGANU](https://www.academia.edu/5095660/CULTURAL_LANDSCAPE_OF_TRADITIONAL_HOUSE_COMPOUNDS_IN_TERENGGANU)

Travel, K. (2021, September 12). *KLOOK*. <https://www.klook.com/en-MY/blog/religious-sites-in-malaysia/>

*Kuala Terengganu Tourism (2023) - Malaysia > Top Places, Travel Guide | Holidify*. (n.d.).  
<https://www.holidify.com/places/kuala-terengganu/>

*Islamic Culture of Terengganu | Travel Itinerary | Garmin Malaysia*. (n.d.). Garmin Malaysia.  
[https://www.garmin.com.my/travelroute/detail/travel\\_046/](https://www.garmin.com.my/travelroute/detail/travel_046/)

Mail, M. (1970, January 1). *Terengganu continues to strengthen tourism, culture in Budget 2020*. Malay Mail. <https://www.malaymail.com/news/malaysia/2019/11/24/terengganu-continues-to-strengthen-tourism-culture-in-budget-2020/1812887>

*International Muslim Travellers' Expectation towards Islamic Hospitality Services in Malaysia - UUM Repository.* (n.d.). <https://repo.uum.edu.my/id/eprint/29131/>

Afthanorhan, A., Awang, Z., & Fazella, S. (2017, September 6). *Perception of Tourism Impact and Support Tourism Development in Terengganu, Malaysia.* Social Sciences; MDPI. <https://doi.org/10.3390/socsci6030106>

Ruzulan, Z., Jamaludin, M. A., & Hashim, K. S. H. Y. (2022, September 14). *Dealing with the Locality at the Islamic Tourism Destination from the Islamic Perspective in Malaysia.* International Academic Symposium of Social Science 2022. <https://doi.org/10.3390/proceedings2022082039>

*Database Update – Malaysia and Islamic tourism.* (n.d.). <https://www.cabi.org/leisuretourism/news/24583>

Yusof, S. Z. (2021, April 18). *Transportation as a Driver for Sustainable Tourism in Terengganu, Malaysia.* [https://papers.ssrn.com/sol3/papers.cfm?abstract\\_id=3832113](https://papers.ssrn.com/sol3/papers.cfm?abstract_id=3832113)

J. (2019, November 3). *The Islamic Heritage Park In Kuala Terengganu.* Tiki Touring Kiwi. <https://www.tikitouringkiwi.com/islamic-civilisation-park-taman-tamadun-islam/>

Z. (n.d.). *Malaysia Tourism Centre (MaTiC) - Religion.* <https://www.matic.gov.my/en/information/about-malaysia/religion>

*Kuala Nerus a sustainable town, full of attractions – UMT | Portal Rasmi Universiti Malaysia Terengganu.* (n.d.). <https://www.umt.edu.my/kuala-nerus-a-sustainable-town-full-of-attractions/>

Hays, J. (n.d.). *ISLAMIC LAW IN MALAYSIA | Facts and Details.* [https://factsanddetails.com/southeast-asia/Malaysia/sub5\\_4d/entry-3677.html](https://factsanddetails.com/southeast-asia/Malaysia/sub5_4d/entry-3677.html)

*Islamic Tourism - Tourism Malaysia Corporate Site.* (n.d.). <https://www.tourism.gov.my/niche/islamic-tourism>

*What is Islamic Tourism | IGI Global.* (n.d.). <https://www.igi-global.com/dictionary/halal-tourism-where-are-we/64707>

Fazella, A. A. Z. A. S. (2017). *Perception of Tourism Impact and Support Tourism Development in Terengganu, Malaysia.* ideas.repec.org. <https://ideas.repec.org/a/gam/jscscx/v6y2017i3p106-d111092.html>

Afthanorhan, A. (2017). *Perception of Tourism Impact and Support Tourism Development in Terengganu, Malaysia.* <https://www.semanticscholar.org/paper/Perception-of-Tourism-Impact-and-Support-Tourism-in-Afthanorhan-Awang/33004b08192f88c2ce70a7ef165886af973da0d6>

*The Road to Old Terengganu | Southeast Asia Travel.* (2020, August 7). Southeast Asia Travel. <https://www.visitsoutheastasia.travel/guides/the-road-to-old-terengganu/>

*Balancing Development and Sustainability in Tourism Destinations.* (n.d.). Google Books. [https://books.google.com.my/books?id=eSIIDQAAQBAJ&pg=PA150&lpg=PA150&dq=perceptions+kuala+terengganu+islamic+tourism&source=bl&ots=T71eOJQm2m&sig=ACfU3U0aOqtOLkF0EiIfvYqlaqDl81W61w&hl=en&sa=X&ved=2ahUKEwiEwdqx497\\_AhXTCt4KHXE2Bog4MhDoAXoECB0QAw#v=onepage&q=perceptions%20kuala%20terengganu%20islamic%20tourism&f=false](https://books.google.com.my/books?id=eSIIDQAAQBAJ&pg=PA150&lpg=PA150&dq=perceptions+kuala+terengganu+islamic+tourism&source=bl&ots=T71eOJQm2m&sig=ACfU3U0aOqtOLkF0EiIfvYqlaqDl81W61w&hl=en&sa=X&ved=2ahUKEwiEwdqx497_AhXTCt4KHXE2Bog4MhDoAXoECB0QAw#v=onepage&q=perceptions%20kuala%20terengganu%20islamic%20tourism&f=false)

*Island Tourism.* (n.d.). Google Books. <https://books.google.com.my/books?id=GWcG9Rc003UC&pg=PA93&lpg=PA93&dq=perceptions+kuala+terengganu+islamic+tourism&source=bl&ots=y3gm8jB2C0&sig=ACfU3U3djoqzDIyT0fghc4kcf4YplQL5CA>

&hl=en&sa=X&ved=2ahUKEwiEwdqx497\_AhXTCt4KHXE2Bog4MhDoAXoECBwQAw#v=onepage&q=perceptions%20kuala%20terengganu%20islamic%20tourism&f=false

*Strong Islamic Awareness Among Key Factors Why Foreigners Love Terengganu.* (2022, February 20). TRDI News. <https://www.trdi.my/strong-islamic-awareness-among-key-factors-why-foreigners-love-terengganu>

*Factors affecting tourists to choose Terengganu as Islamic tourism destination - Digital Special Collection (UMK Repository).* (n.d.). <http://discol.umk.edu.my/id/eprint/3806/>

Çifci, S., Japutra, A., Ekinci, Y., & Gordon-Wilson, S. (2022). Does brand concept mapping determine destination brand associations and image? *Tourism Analysis*, 27(4), 515–528. <https://doi.org/10.3727/108354222x16479671274081>

Mody, M., Day, J., Sydnor, S., Lehto, X., & Jaffé, W. (2017). Integrating country and brand images: Using the product—Country image framework to understand travelers' loyalty towards responsible tourism operators. *Tourism Management Perspectives*, 24, 139–150. <https://doi.org/10.1016/j.tmp.2017.08.001>

Kwanisai, G., & Vengesayi, S. (2016, April 4). Destination Attributes and Overall Destination Satisfaction in Zimbabwe. *Tourism Analysis*, 21(1), 17–28. <https://doi.org/10.3727/108354216x14537459508775>

Zhang, Y., & Ha, H. Y. (2022, June 21). Do consumers value all destination attributes equally over time? the dynamic nature of individual-level attributes and their outcomes. *Current Issues in Tourism*, 1–12. <https://doi.org/10.1080/13683500.2022.2088338Eusébio>

C., & Vieira, A. L. (2011, November 2). Destination Attributes' Evaluation, Satisfaction, and Behavioural Intentions: a Structural Modelling Approach. *International Journal of Tourism Research*, 15(1), 66–80. <https://doi.org/10.1002/jtr.877>

Lu, W., & Stepchenkova, S. (2012, June). Ecotourism experiences reported online: Classification of satisfaction attributes. *Tourism Management*, 33(3), 702–712. <https://doi.org/10.1016/j.tourman.2011.08.003>

Abu Bakar, B. (2020, April). Integrating spirituality in tourism higher education: A study of tourism educators' perspectives. *Tourism Management Perspectives*, 34, 100653. <https://doi.org/10.1016/j.tmp.2020.100653Belhassen>,

Y., & Bowler, B. (2017, October). An interview about spirituality and tourism: Theory and practice in dialogue. *Tourism Management Perspectives*, 24, 188–192. <https://doi.org/10.1016/j.tmp.2017.07.010Cheer>,

J. M., Belhassen, Y., & Kujawa, J. (2017, October). The search for spirituality in tourism: Toward a conceptual framework for spiritual tourism. *Tourism Management Perspectives*, 24, 252–256. <https://doi.org/10.1016/j.tmp.2017.07.018Bertella>,

G. (2022, September). 'Spirituality in practice' in sustainable tourism research. *Journal of Qualitative Research in Tourism*, 3(1), 65–72. <https://doi.org/10.4337/jqrt.2022.0003>

Ballina Ballina, F. J. (2020, September 15). Smart tourism destination, physical experience, and rural tourism. *Smart Tourism*, 1(2), 11. <https://doi.org/10.54517/st.v1i2.1697>

### [Google Scholar](#)

Schwarz, N. (2003). "Self-reports in Consumer Research: The Challenge of Comparing Cohorts and Cultures." *Journal of Consumer Research*, 29 (4): 588-594.

Stauss, B., and P. Mang (1999). "'Culture Shocks' in Inter-cultural Service Encounters?" *Journal of Service Management*, 13 (4/5): 329-346.

Sundaram, D. S., and C. Webster (2000). "The Role of Nonverbal Communication in Service Encounters." *Journal of Services Marketing*, 14 (5): 378-391.

Weiermair, K. (2000). "Tourists' Perceptions Towards and Satisfaction with Service Quality in the Cross-Cultural Service Encounter: Implications for Hospitality and Tourism Management." *Managing Service Quality*, 10 (6): 397-409.

Winsted, K. F. (1997). "The Service Experience in Two Cultures: A Behavioral Perspective." *Journal of Retailing*, 73 (3): 337-360.

Zeithaml, V. A., and M. J. Bitner (2000). *Service Marketing: Integrating Customer Focus Across the Firm*. New York: McGraw-Hill. Mohamad, Z. Z., & Mohamad, N. (2014). The Potential of Islamic Tourism in Kuala Terengganu: An Analysis of Tourists' Perception. *International Journal of Tourism Research*, 16(5), 440-451. [DOI: 10.1002/jtr.1975]

Mohd Ali, S. S., Omar, N. A., & Mohd Shafie, S. (2015). Factors Influencing International Muslim Tourists' Decision in Selecting Halal Food Restaurants in Kuala Terengganu, Malaysia. *Procedia-Social and Behavioral Sciences*, 172, 643-650. [DOI: 10.1016/j.sbspro.2015.01.368]

Abdul Rahman, N. H., & Othman, S. N. (2016). Development of Halal Tourism Destination in Malaysia: A Case Study of Kuala Terengganu. *Procedia-Social and Behavioral Sciences*, 222, 563-571. [DOI: 10.1016/j.sbspro.2016.05.206]

Ahmad, N. A., & Mohamad, N. (2017). Islamic Tourism Destination: A Study on Tourists' Perception of Kuala Terengganu, Malaysia. *Advanced Science Letters*, 23(9), 8721-8724. [DOI: 10.1166/asl.2017.9872]

Che Omar, R., Mohamed, A. R., & Ismail, N. H. (2018). Factors Influencing Muslim Tourists' Intention to Visit Islamic Heritage Tourism Destination: A Study of Kuala Terengganu, Malaysia. *Advanced Science Letters*, 24(12), 9223-9226. [DOI: 10.1166/asl.2018.13099]

Abd. Jalil, H. (2019). The Roles of Islamic Tourism in Socioeconomic Development: Case Study of Kuala Terengganu, Malaysia. *Journal of Contemporary Islamic Studies*, 5(2), 51-72. [DOI: 10.7193/jcis.v5i2.201]

Mohamed, A. R., Mustafa, N. H., & Ismail, N. H. (2014). Islamic Tourism Development in Malaysia: The Case of Kuala Terengganu. *International Journal of Business and Society*, 15(2), 309-324. [Retrieved from [https://www.ijbs.unimas.my/repository/pdf/VOL15\\_NO2\\_AR11.pdf](https://www.ijbs.unimas.my/repository/pdf/VOL15_NO2_AR11.pdf)]

Zainol, N. R., & Daud, N. M. (2013). The Potential of Islamic Tourism in Malaysia: A Case Study of Kuala Terengganu. *Journal of Tourism, Hospitality, and Culinary Arts*, 5(3), 1-18. [Retrieved from [https://www.jthca.org/archives/vol5\\_issue3\\_full/paper\\_1\\_v5\\_i3\\_jthca.pdf](https://www.jthca.org/archives/vol5_issue3_full/paper_1_v5_i3_jthca.pdf)]

Nordin, S. M., & Mohezar, S. (2012). Potential of Islamic Tourism in Malaysia: A Study on International Muslim Tourists' Perception of Kuala Terengganu. *International Journal of Business and Social Science*, 3(15), 285-293. [Retrieved from [https://www.ijbssnet.com/journals/Vol\\_3\\_No\\_15\\_Special\\_Issue\\_August\\_2012/33.pdf](https://www.ijbssnet.com/journals/Vol_3_No_15_Special_Issue_August_2012/33.pdf)]

Zainol, N. R., Daud, N. M., & Zainal, Z. (2015). Islamic Tourism Destination: A Comparative Study between Kuala Terengganu and Kota Bharu, Malaysia. *Journal of Business and Social Development*, 3(2), 12-19. [Retrieved from <http://myjms.moe.gov.my/index.php/jbsd/article/view/3997/2002>]

Chik, C. T., & Mohamed, A. R. (2018). Islamic Tourism Marketing Strategies: A Study of Kuala Terengganu, Malaysia. *Asia Pacific Journal of Tourism Research*, 23(1), 41-59. [DOI: 10.1080/10941665.2017.1419594]

Nordin, S. M., & Mohezar, S. (2012). Muslim Tourists' Perception of Kuala Terengganu as an Islamic Heritage Tourism Destination. *Journal of Travel and Tourism Marketing*, 29(2), 105-120. [DOI: 10.1080/10548408.2012.651387]

Rahim, M. M. A., Hussain, M. Y., & Talib, S. (2020). Islamic Tourism Destination and Visitor Satisfaction: A Study of Kuala Terengganu, Malaysia. *Journal of Islamic Marketing*, 11(6), 1357-1373. [DOI: 10.1108/JIMA-06-2019-0119]

Abd Jalil, H., & Bakar, A. H. A. (2019). The Perception of Islamic Tourism Stakeholders in Kuala Terengganu, Malaysia. *Journal of Islamic Marketing*, 10(4), 1209-1224. [DOI: 10.1108/JIMA-07-2018-0104]

Amin, M., Osman, A., & Othman, N. (2021). Muslim Travelers' Experiences in Kuala Terengganu, Malaysia. *Journal of Halal Tourism Research*, 3(1), 58-73. [DOI: 10.22037/jhtr.v3i1.30651]



## **The Effect Of Perceived Impact, Social Impact And Environmental Impact On Tourism Development In Sabah, Malaysia Among Indigenous People**

**Muhd Najib bin Rani, Najwa Edliena Binti Hashim, Nasreen Nadhirah Binti Binti Mohd Zuki, Nayli Fatini Binti Zuel Azwar \* Mohanad S. S. Abumandil**

*Faculty Of Hospitality, Tourism and Wellness, University Malaysia Kelantan*

*Corresponding email: mohanad.ssa@umk.edu.my*

---

### **ABSTRACT**

*This study's objective is to evaluate the engagement of native populations in tourist and conservation development initiatives. More specifically, the research will concentrate on the indigenous population of Sabah, which is located in Malaysia. We develop a framework for understanding the elements that influence the participation choices of this community using the motive, opportunity, and ability model. This model is used to understand the factors that drive the participation choices of this community. Based on the findings, it appears that indigenous people's engagement can be positively influenced by their levels of knowledge and awareness (ability), as well as their perceptions of the environmental and economic implications of tourism (motivation). In addition, the findings of this research do not lend credence to the idea that opportunity or the perceived social consequences of tourism have an effect on involvement.*

**Keywords: Ability, Motivation,**

---

### **INTRODUCTION**

The traditional culture and way of life of indigenous populations are frequently a draw for domestic and foreign tourists, and they can have a big impact on how competitive a place is (Fletcher, Pforr & Brueckner, 2016). However, the voice and knowledge from indigenous people should be involved in their planning, legislation, and development to guarantee that such places are sustainable (Butler & Hinch, 2007; Fletcher, 2016). As a result, needs, objectives, and preferences of indigenous communities should be taken into consideration by all tiers of government and business. (Carr, Ruhanen & Whitford, 2016).

Social obligations, cultural standards, and morals. Differences between environmentalists and indigenous people may make it difficult for them to understand one another (Carr, 2016; Chicchon, 2009). Although the relationship between indigenous people and the outside world is meant to be one of sincere respect, in most cases this relationship begins with misunderstanding because of unequal land distribution that favours one party or because indigenous people admit that these connections or exchanges do not benefit them (Carr, 2016; Chicchon, 2009; Fletcher, 2016). Therefore, it is vital to understand and take into account the objectives of indigenous peoples when establishing strategies for the protection of biodiversity or of land, in addition to setting conservation goals as soon as feasible.

There are research objectives of our study:

1. To identify the perceived economic impact on tourism development in Sabah.
2. To identify the perceived social impact on tourism development in Sabah.
3. To identify the perceived environmental impact on tourism development in Sabah.

## **SIGNIFICANCE OF THE STUDY**

The academic community and event participants in general will benefit from a number of significant theoretical and managerial contributions from this study. This research will probably add to the growing body of knowledge concerning Sabah's tourism industry. At the same time, the future research may extend the body of literature in tourism and hospitality research.

This study primary objective is to determine the challenges that have been encountered during the growth of the tourism industry in Sabah from a more practical point of view. Furthermore, the organizer can utilize this measurement as an option in contrast to analyzing satisfaction performance in terms of their expert knowledge throughout the implementation and to better understand the desires and needs of Sabah's tourism development.

## **LITERATURE REVIEW**

### ***Tourism Development***

To answer the question of whether or not the impact of tourism development on economic growth is dependent on the amount of economic development already present in a country, we will return to the contentious topic of the relationship between the two. Within the limitations of a Note, it is only possible for us to discuss previous material in a constrained manner, as stated by the most recent review carried out by (Castro-Nuno et al., 2013). tourism's impact on the world's ecosystems. Beyond Sustainability raises issues about the paradigm of sustainable tourism development, which, for the past 20 years, has been the preeminent theoretical and applied approach for the growth of the travel industry. Beyond Sustainability argues that this paradigm needs to be reexamined. It goes beyond the somewhat managerialist "blueprint" and destination-focused approach that characterize even the most recent agenda for "sustainability" in tourist infrastructure development. The author draws parallels between the current political-economic, socio-cultural, and environmental contexts and the limitations of sustainable tourism development. To do so, they examine the historical development of the concept, its contemporary representations in contemporary scholarly literature, as well as changes in policy and the processes that underlie such changes.

### ***Perceived Economic Impact***

The tourism industry contributes positively to the economy in a number of ways, including an increase in personal income and tax revenue, an improvement in the general quality of life, and the creation of additional employment opportunities. Examples of sociocultural influences include interactions between people of different cultural origins, attitudes and behaviors, and linkages to material items. Sociocultural influences can also be seen in the world around us. Tourism has the potential to aid indigenous people in a number of ways, including reducing poverty, diversifying economic activity, and increasing demand for and sales of indigenous goods and services. These positive effects need to be weighed against the potential negative economic repercussions, which may include higher expenses of living, higher real estate prices and property taxes, rises in the cost of products and services globally, and a preference for jobs in the tourism industry that pay lower wages.

### ***Perceived Social Impact***

Numerous things, including the development of new areas for recreation and entertainment, the clarification of a community's sense of cultural identity, the encouragement of locals to take pride in their culture, and the promotion of the revival and preservation of traditional arts, culture, and crafts are all things that tourism can assist with (Jaafar, 2017; McGehee, 2002). The social and cultural life of a culture can be impacted by tourism in both positive and negative ways, with the former effects being more likely to be felt by rural communities and indigenous peoples than the latter. This is particularly valid when there are lots of tourists present (Bennett, 2012).

### ***Perceived Environmental Impact***

However, irresponsible tourism can also have negative consequences on the neighborhood and the environment. Travel that isn't self-centered and doesn't pay enough attention to how travel affects society and the environment is referred to as responsible tourism, for example, may have an effect on quality of the water, whereas trekking and climbing could have a negative effect on plants and vegetation. For the sake of communities, potential tourists, and the next generation, the tourism business must therefore maintain its sustainability while preserving current resources and tourist attractions. Visitors coming at any tourist site have varying behaviors or attitudes regarding that region due to the diversity of motivations that motivate travel (Spenceley, 2008).

## **RESEARCH HYPOTHESIS**

In this study, there were three hypotheses tested are:

1. The perceived economic impact of establishing protected areas and tourism development have a positive effect on the participation of indigenous people in conservation programs and tourism development.

2. The perceived social impact of establishing protected areas and tourism development have a positive effect on the participation of indigenous people in conservation programs and tourism development.

3. The perceived environment impact of establishing protected areas and tourism development have a positive effect on the participation of indigenous people in conservation programs and tourism development.

## RESEARCH FRAMEWORK

This framework demonstrates by the summary of the related research, a conceptual framework that identifies the participation in conservation and tourism. The study determined the perspective of perceived economic impact, social impact and environmental impact.

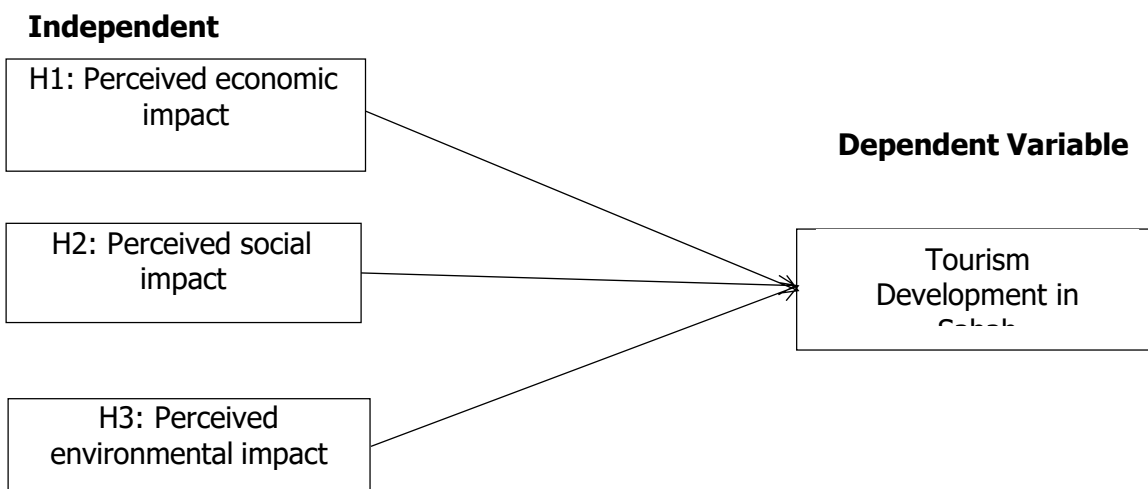

Figure 1: Research Framework

## METHODOLOGY

### Research Design

The quantitative methods used in this study to gain the data from respondents through questionnaire via Google Form from hashtag at TikTok apps. The questionnaire was designed in two language which are English and Malay to make sure respondents understand the question. The questionnaire was divided by 3 section, which section A, B and C. There have a 5point Likert with closed-ended questionnaire ranging from (1) "Strongly Disagree" to (5) "Strongly Agree" used in measuring all the variable.

## Data Collection

Firstly, the researcher spreading 150 set questionnaires to the respondents via TikTok apps with the hashtag #KamiOrangSabah. The questionnaire fulfilled by the Sabahan people especially to the Kinabatangan people. Researcher takes time almost 3 weeks to complete 150 respondents.

## Sampling

The-non probability sampling used in this study and known as convenience sampling. Convenience sampling involves selecting participants who are often ready and available. It appears to be a favorite student technique because it is inexpensive and straightforward than the other sampling technique.

## Data Analysis

All data collected via the self-administrated questionnaire were analyzed using the statistical package for social sciences (SPSS) latest version and the necessary measures were implemented. SPSS is one of the appropriate programmed for conducting data analysis.

## FINDINGS

### Result of Frequency Analysis

Table 1 shows the result of frequency analysis of respondents.

Table 1: Frequency Analysis

	Demographic characteristics	Frequency	Percentage (%)
<b>Gander</b>			
Male		42	28.0
Female		108	72.0
<b>Age group</b>			
20 – 29 years old		136	90.7
30 – 39 years old		12	8.0
40 – 49 years old		2	1.3
<b>Race</b>			
Chinese		9	6.0
Indian		5	3.3
Malay		133	88.7
Others		3	2.0
<b>Religion</b>			
Buddha		3	2.0
Hindu		5	3.3
Islam		135	90.0
Kristian		7	4.7

<b>Education level</b>		
Certificate or Diploma	10	6.7
Degree	130	86.7
Master	6	4.0
No Formal Education	4	2.7

Table 1 shows the result of frequency analysis of respondents. The research focus on the indigenous people in Kinabatangan, Sabah. The result shows that the female respondent is the highest which is 108 respondents (72%) while male respondent is 42 respondents (28%). Next, majority of respondent in age group was from 20 – 29 years old respondents which is 136 respondents (90.7%) while 30 -39 years old is 12 respondents (8%) and 40 – 49 years old respondent is only 2 respondents (1.3%). Next, most of the respondent's race are Malay which is 133 respondents (88.7%) while Chinese respondent is 9 respondents (6%), other than that, Indian respondent is 5 respondents (3.3%), lastly, for others race is 3 respondents which is (2%). In addition, the religion of this result shows that from the Islam religion is the greater which is 135 respondent (90%), the second highest is Kristian religion which is 7 respondents (4.7%), next is Hindu religion have 5 respondents (3.3%) and lastly, Buddha religion which is 3 respondents (2.0%). Last but not least, the highest respondent from education level was from Degree respondent which is 130 respondents (86.7%), the second highest is from Certificate or Diploma Level which is 10 respondents (6.7%), next is Master level which is 6 respondents (4%) and lastly, for No Formal Education Level there are 4 respondents which is (2.7%).

### **Result of Descriptive Analysis**

Table 2 shows the result of descriptive analysis of variable

Table 2 : descriptive analysis

<b>Variable</b>	<b>Items</b>	<b>Mean Score</b>	<b>Standard Deviation</b>
<b>Tourism development in Sabah</b>	Do you think the tourist development has a positive effect on the indigenous people in Sabah?	4.66	0.572
	Do you think that the tourist development can change the economy in terms of many job opportunities so as to reduce the poverty of the indigenous people?	4.83	0.417
	Does the tourist development in Sabah not affect the environment?	4.60	0.691

	Do you think the tourist development provides progress in a good way of life and opens up a broad and mature mindset for the indigenous people in Sabah?	4.70	0.495
	Do you think the tourist development must be emphasized more for the life of the indigenous people in Sabah?	4.66	0.615
<b>Perceived economic impact</b>	Do you think that the success of many economies throughout the world depends on tourism?	4.11	1.024
	For indigenous people, do you think that tourism can alleviate poverty, diversify economic activities, and increase the demand for and sale of indigenous goods and services	4.14	1.017
	Do you think that in the wake of tourism development can give the bad impact to the environment?	3.91	0.969
	It is very important to indigenous communities to increased wildlife population, improving the rainforest, and protecting rivers and natural asset to the way of their life. Do you think that the development of tourism can also result in the establishment of protected wildlife and heritage areas?	3.95	0.965
	Do you think that economic is important to the indigenous people?	4.06	0.935
<b>Perceived social impact</b>	Do you think the social impact of tourism development in Sabah can improve infrastructure such as roads, schools, hospitals and parks.	4.16	0.977
	With the social impact on the development of tourism in Sabah, do you think tourism can encourages a variety of cultural activities?	4.17	0.999
	Do you think tourism development increases the availability of recreation opportunities in local community?	4.09	0.979
	Do you think tourism causes congestion and is unpleasant to the local community?	3.93	1.030
	Do you think tourism increases crime in the local community?	3.86	1.056
<b>Perceived environmental impact</b>	Do you think the effects of the developed development will have a negative impact on the environment?	3.99	0.909
	Do you think uncontrolled development will be the cause of air pollution?	4.07	0.924
	Do you think the progress carried out in Sabah will destroy the sustainability of the environment in Sabah, especially in the indigenous villages?	3.90	1.035
	Do you think the development carried out will damage the natural treasures in Sabah?	3.90	1.022

Do you think the development that is being carried out will fail the current agenda which is the agenda of sustainable development?	3.95	0.958
---	------	-------

Table 2 was represented the descriptive analysis of variable. Based on dependent variable of this study, tourism development in Sabah descriptive analysis, the highest mean score is 4.83 it is “Do you think that the tourist development can change the economy in terms of many job opportunities so as to reduce the poverty of the indigenous people?” with standard deviation is (0.417) in our 52 research. Other than that, for the questions “Does the tourist development in Sabah not affect the environment?” has 4.60 the lowest mean score with (0.691) at standard deviation. Next, for the first independent variable, perceived economic impact, questions number 2 " For indigenous people, do you think that tourism can alleviate poverty, diversify economic activities, and increase the demand for and sale of indigenous goods and services” were showed the highest mean score, it is 4.14 with standard deviation is (0.017) in our research. In addition, for lowest of the mean score, which is “Do you think that in the wake of tourism development can give the bad impact to the environment?” which is 3.91 with standard deviation (0.969). Besides, for the second independent variable which is perceived social impact, the results of the highest mean score stated that question number 2, “With the social impact on the development of tourism in Sabah, do you think tourism can encourages a variety of cultural activities?” With mean 4.17 SD= 0.999 while the results of the lowest mean score was stated that question number 5, “Do you think tourism increases crime in the local community?” With (M= 3.86, SD= 1.056). Lastly, for the third independent variable which is perceived environmental impact, the question number 2 with the greatest average score was " Do you think uncontrolled development will be the cause of air pollution?" (Mean 4.07 SD= 0.924), while the question with the lowest average score was " Do you think the development carried out will damage the natural treasures in Sabah?" (Mean 3.90 SD= 1.022).

### Result of Reliability Analysis

Table 3 shows the result of reliability analysis based on dependent variable and independent variable.

Table 3: Reliability Analysis

Variable	Number of items	Cronbach's Alpha
Perceived economic impact	5	0.774
Perceived social impact	5	0.779
Perceived environmental impact	5	0.820



In this particular study, the variables were measured by means of a reliability test. According to table 3, all of the variables had an alpha coefficient value that was larger than 0.7, which indicates a strength of connection that is moderate. A Cronbach's Alpha value of 0.774 was assigned to the perceived economic impact, which was followed by the perceived social impact, which was assigned a value of 0.779, and the perceived environmental impact, which was assigned a value of 0.820. According to the findings, all of the independent variables as well as the dependent variables are virtually continuous and dependable, with connections ranging from good to very good (Taber, 2017).

### Result of Pearson Correlation Analysis

Table 4 shows the result of Pearson correlation analysis based on the hypothesis.

Table 4: Pearson Correlation Analysis

Hypothesis	P-Value	Result (Support/ Not Support)
H1 – There is a significant relationship between perceived economic impact and tourism development in Sabah	0.001	H1 is supported
H2 – There is a significant relationship between perceived social impact and tourism development in Sabah	0.001	H2 is supported
H3 – There is a significant relationship between perceived environmental impact and tourism development in Sabah	0.001	H3 is supported

### DISCUSSION

The discussion is aimed both local and international tourists will be increasingly aware of indigenous tourism. Native American tribes who retain their ancient ways of life are typically a top attraction for both domestic and international travellers, and they have a significant influence on how competitive a location is. Despite having various traditions and cultures, they are all vulnerable to the same harsh realities, including being driven out of their native nations, being physically attacked, and being treated like second-class citizens. Participating locals in conservation planning and management not only increases engagement but also strengthens the bonds between different groups and the regional biodiversity protection goal. As a result, all levels of government as well as the corporate sector should be knowledgeable about the requirements, objectives, and preferences of indigenous populations.

## CONCLUSION

This study was carried out to investigate the elements that determine the influence of perceived economic, social, and environmental impact on the development of tourism among indigenous people in Sabah, Malaysia. Sabah is located in Malaysia. The findings and conclusions of this study are presented in this section. The important determinants (independent variables) in tourist development among indigenous people in Sabah, Malaysia, are the perceived economic impact, perceived social impact, and perceived environmental impact (dependent variable). In Chapter 3, it was mentioned that in order to carry out these surveys, the researchers employed Google Form with a total of 150 participants as responders. Indigenous people from the state of Sabah are represented among those who filled out and returned these questionnaires as responders. In addition to employing the qualitative technique, the researcher makes use of the quantitative method when it comes to the collection of data and information. In addition, the researcher uses social media sites like as Facebook and TikTok to communicate with potential respondents in the state of Sabah. Because employing them makes it easier for responders to finish filling out all of the questions, which in turn enables the researcher to save both time and money, this is the reason behind this.

In this investigation, the results of a questionnaire survey were submitted to a variety of analyses, including descriptive analysis, reliability analysis, correlation analysis, and frequency analysis. These analyses were carried out in order to draw conclusions about the findings of the investigation. After that, using a piece of software known as the Statistical Package for the Social Science (SPSS), all of the results that were obtained in the previous chapter as well as the data from the questionnaire were examined. The researchers have decided to use this particular piece of software since it significantly simplifies the process of locating each and every result. In conclusion, there is further information to summarize, and it is possible to draw inferences about the final result based on the examination of the data. In light of the findings of this investigation, all 67 of the hypotheses numbered 1 through 3 (H1, H2, and H3) can be accepted as true. In addition, we came up with several suggestions as well as some limitations for this research, both of which, in our opinion, will prove to be beneficial to future researchers in the years to come. As a consequence of this, it is wished that the later researcher would consider each and every piece of information provided throughout this investigation to be of use..

## REFERENCES

- Akter, M., Sadekin, M. N., & Patwary, A. K. (2020). An Empirical Study on Students' Satisfaction from Mawlana Bhashani Science & Technology University, Bangladesh. *Review of Economics and Development Studies*, 6(2), 363-379.
- Alicia Tuovila. (2007, June 26). *Sampling: What it is, different types, and how auditors and marketers use it*. Investopedia. <https://www.investopedia.com/terms/s/sampling.asp>
- Alom, S., Patwary, A. K., & Khan, M. M. H. (2019). Factors affecting the turnover intention of Bangladeshi migrants in the United Arab Emirates: An empirical study on the hotel industry. *International Journal of Innovation, Creativity and Change*, 8(3), 344-360.

- Asghar Afshar Jahanshahi, Mohammad Ali and Khaled Nawaser. (2011). Study the Effect of customer service and product quality on customer satisfaction and loyalty. *Paripex Indian Journal of Research*, 3(8), pp.191-194
- Babbie, E. R. (2013). *The basics of social research*: Cengage Learning.
- Dan Fleetwood. (2022, October 4). *Types of sampling: Sampling methods with examples*. QuestionPro. <https://www.questionpro.com/blog/types-of-sampling-for-social-research>
- Dr. Lonny. (2020, March 11). *What is the importance of sampling in research? - My dissertation coach*. My Dissertation Coach. <https://mydissertation.coach/q-and-a/what-is-the-importance-of-sampling-in-research>
- Feenstra, G. W. (2009). Local food systems and sustainable communities. *American Journal of Alternative Agriculture*, 28-36.
- Fengmin, Z., Baijun, W., Jiangtao, B., Li, L., & Patwary, A. K. (2022). Investigating revisit intention of medical tourists in China through nutritional knowledge, perceived medical quality, and trust in the physiologist: A recommendation on health tourism policy measures. *Frontiers in Public Health*, 10, 893497.
- Gogtay, N. J., & Thatte, U. M. (2017). Principles of correlation analysis. *Journal of the Association of Physicians of India*, 65(3): 78-81.
- Hanan, H. & Hamid, Z.A. (2017). Tourist perception towards Kelantanese food image. *Journal of Tourism, Hospitality & Culinary Arts*, 9(2): 443-452.
- Hand, M. (2018). What is Local Food? *U.S. DEPARTMENT OF AGRICULTURE*.
- Hazbar, A. M. H., Alem Mohammed, A., & Karim, A. K. A. (2019). An Empirical Study of Factors Influencing hotel customers' online booking Intention. *مجلة العلوم التربوية و الدراسات الإنسانية*, (5), 1-17.
- Hulin, C., Netemeyer, R., & Cudeck, R. (2001). Can a Reliability Coefficient Be Too High? *Journal of Consumer Psychology*, 10, 55-58.
- Iqbal, Qaisar, and Siti Hasnah Binti Hassan. (2016). Service Quality about Health Sector of UK and Pakistan: A Comparative Study. *International Journal of Management, Accounting and Economics* 3: 473–85.
- Iqbal, Qaisar, and Siti Hasnah Hassan. (2018). A Dyadic Analysis of Salespersons and Customers in the Banking Sector: Humor Usage, Word of Mouth and Expectation of Continuity. *International Academic Journal of Business Management* 5: 109–120.
- Iqbal, Qaisar, Basheer Ahmad, and Adeel Nasim. (2016). A Gender Based Approach: Service Quality and Customer's Loyalty. *International Journal of Management, Accounting and Economics* 3: 822–36.
- Li, L., Ragavan, N. A., Patwary, A. K., & Baijun, W. (2022). Measuring patients' satisfaction toward health tourism in Malaysia through hospital environment, nutritional advice, and perceived value: A study on Chinese exchange students. *Frontiers in public health*, 10, 893439.
- Li, L., Wu, B., & Patwary, A. K. (2022). How marine tourism promote financial development in sustainable economy: new evidences from South Asia and implications to future tourism students. *Environmental Science and Pollution Research*, 29, 1155-1172.
- Li, L., Wu, B., & Patwary, A. K. (2022). The psychosocial factors affecting chinese Outbound Exchange and mobility students' academic performance during COVID-19. *Frontiers in psychology*, 13, 872516.
- Ma, Yaxin, and Shaohua Yang. (2018). An Empirical Study of Female E-shopper's Satisfaction with Cosmetic Products in China. *International Journal of Business and Management* 13: 211.

- Martinez Garcia, Jose Antonio, and Laura Martinez Caro. (2010). Rethinking perceived service quality: An alternative to hierarchical and multidimensional models. *Total Quality Management* 21: 93–118.
- McCombes, S. (2022, December 1). *Sampling Methods | Types, Techniques & Examples*. Scribbr. <https://www.scribbr.com/methodology/sampling-methods/>
- Nunally, J. C., & Bernstein, I. (1978). Psychometric Theory, ed. *New York McGraw*. Saunders et al 2009, *Sampling - Chapter 7 Whatever Your Research Question (S) and Objectives You*.
- Oosterbaan, R.J. (1988). *Frequency predictions and their binomial confidence limits*. In: *Economic Aspects of flood control and non-structural measures, Proceedings of the Special Technical Session of the International Commission on Irrigation and Drainage (ICID)*, Dubrovnik, pp. 149-160.
- Patwary, A. K., Roy, B., Hoque, R., & Khandakar, M. S. A. (2019). Process of developing a community based tourism and identifying its economic and social impacts: An Empirical study on Cox's Bazar, Bangladesh. *Pakistan Journal of Humanities and Social Sciences*, 7(1), 1-13.
- Pellinen, J. (2003). *Making price decisions in tourism enterprises*. *International Journal of Hospitality Management*, 22(2), 217–235.
- Raajpoot, Nusser A. (2002). A Multiple Item Scale for Measuring Tangible Quality in the Foodservice Industry. *Journal of Foodservice Business Research* 5: 109–27.
- Ryu, K., & (Shawn) Jang, S. (2008). *DINESCAPE: A Scale for Customers' Perception of Dining Environments*. *Journal of Foodservice Business Research*, 11(1), 2–22.
- Ryu, K., & Jang, S. (Shawn). (2006). *Intention to Experience Local Cuisine in a Travel Destination: The Modified Theory of Reasoned Action*. *Journal of Hospitality & Tourism Research*, 30(4), 507–516.
- Sarmiento, R., & Costa, V. (2017). Descriptive analysis. *Comparative Approaches to Using R and Python for Statistical Data Analysis*, 83–113. <https://doi.org/10.4018/978-1-68318-016-6.ch004>
- Schiffman et al. (2012). *African Journal of Hospitality, Tourism and Leisure*, 4 (2), 4-17.
- Shields, P. M., & Rangarajan, N. (2013). *A playbook for research methods: Integrating conceptual frameworks and project management*: New Forums Press.
- Sulek, Joanne M., and Rhonda L. Hensley. (2014). The Relative Importance of Food, Atmosphere, and Fairness of Wait: The Case of a Full-Service Restaurant. *Cornell Hotel and Restaurant Administration Quarterly* 45: 235–47.
- Sumethokula, P., Patwary, A. K., Srinuanpanc, B., Srinuanpand, C., Suwandee, P., Thammathikul, A., & Phanong, W. (2020). The potential of new tour repackaging for creative tourism among entrepreneurs in Nakhon Si Thammarat. *International Journal of Innovation, Creativity and Change*, 13(10), 1752-1771.
- Sundar Rao PS, Richard J. 4th ed. New Delhi: Prentice Hall of India Pvt Ltd; (2006). *Introduction to biostatistics and research methods*.
- Susskind, Alex M., and Edwin K. Chan. (2000). How Restaurant Features Affect Check Averages: A Study of the Toronto Restaurant Market. *Cornell Hotel and Restaurant Administration Quarterly* 41: 56–63.

- Uzunboylu, N. (2015). *Service Quality in International Conference Industry; A Case Study of WCES 2015*.
- Wu, B., Liu, S., Wang, J., Tahir, S., & Patwary, A. K. (2021). Assessing the mechanism of energy efficiency and energy poverty alleviation based on environmental regulation policy measures. *Environmental Science and Pollution Research*, 28, 40858-40870.

# ANALYSIS OF THE IMPACT ON HALAL TOURISM TOWARDS TOURISM STUDENTS AT UNIVERSITI MALAYSIA KELANTAN

**NOOR AINI MASSYITAH BINTI BAHARUDDIN, NIK ALIF FAHMI BIN NIK MOHD ASSRI, NAZIRAWANI BINTI MOHD ZARIEA, NIK HANNANI BINTI ABDUL AZIZ, MOHANAD S.S. ABUMANDIL\***

*Faculty of Hospitality, Tourism and Wellness, University Malaysia Kelantan*

*Corresponding email: [mohanad.ssa@umk.edu.my](mailto:mohanad.ssa@umk.edu.my)*

---

## ABSTRACT

Halal tourism, also known as halal-friendly tourism, is crucial for Muslim students and non-Muslim visitors as it caters to Muslim families adhering to Islamic law. This study examines service quality, tourist contentment, destination image, and loyalty to increase visitor pleasure and repeat business. The quality and cost of a vacation are significantly impacted by using halal food items and non-halal services. University Malaysia Kelantan tourism students should restrict non-halal services and examine halal food product services, as satisfaction is determined by quality and cost. Researchers must achieve their objectives and ensure reproducibility to achieve their research objectives. The methodology provides a comprehensive account of the research process, guiding readers through the process and evaluating the study's validity and reliability. A summary of the findings summarizes the major findings and observations, highlighting average means and levels of agreement for assertions related to Halal Tourism.

**Keywords:** BANNING NON-HALAL SERVICES, GENERAL HALAL SERVICES, HALAL FOOD PRODUCT SERVICES, SATISFACTION.

---

## INTRODUCTION

Halal tourism, also known as halal-friendly tourism, caters to Muslim families following Islamic law. It includes hotels without alcohol, separate spa and swimming areas, halal meals, prayer rooms, and common areas. This type of tourism is particularly important for Muslim students who want to unwind after studying. The study aims to understand how Muslim students navigate their travels and explore the effects of halal tourism on non-Muslim visitors. Halal tourism is Muslim-friendly, offering holiday equipment without prohibited substances and religious activities.

This approach helps Muslim tourists travel easily and reduces travel costs. The Muslim tourism industry is third in terms of global travel spending, with Muslim travel increasing the global GDP by over US\$156 billion in 2016 and projected to do so again in 2020. Consequently, tourism industry is considered as one of the pillars that stimulate the world economic growth (Nasir &

Wongchestha, 2022). The study aims to understand the importance of halal travel in the contemporary world.

There are three objectives of this research -

1. To study the opportunity of banning non-halal services towards satisfaction of tourism students at University Malaysia Kelantan.
2. To examine general halal services towards satisfaction of tourism students at University Malaysia Kelantan.
3. To investigate the need of Halal food product services towards satisfaction for tourism students at University Malaysia Kelantan.

### **SIGNIFICANCE OF THE STUDY**

Based on the study, it can contribute to individual, which can easily find out the most impact on halal tourism towards tourism students at University Malaysia Kelantan. This allows them to have a better experience by having the halal food during the period. Moreover, the experience of conducting halal tourism can allow them to have the feeling of satisfying towards the halal food. Indirectly, it can help the individual to prepare themselves for conducting the satisfaction of it.

Besides that, this research can be used as a valuable reference for further investigation. By conducting further investigation, this may be the second tool in using other types of methodologies to be conducting the impact on halal tourism towards UMK's students. Therefore, the investigator needs to learn and understand more about the halal tourism and its impact on it. For future investigator to know whether student's perception on halal tourism and what does the effects of it to the UMK students.

### **LITERATURE REVIEW**

#### **NON-HALAL SERVICES**

Halal goods and services are not only advertised to Muslims in Malaysia. They are also advertised to non-Muslims, considering that this is an opportunity to promote better cultural exchange and advertising within the nation between Muslims and non-Muslims.

## GENERAL HALAL SERVICES

In Malaysia, "Muslim-friendly hotels" are common place that offer halal food, alcohol-free drinks, prayer mats and surau with the call to prayer to Muslim tourists who follow Islamic beliefs. Due to security and privacy concerns, the researcher's study of hotels in Malaysia revealed that isolated lodging is also accessible in "women only floor" and "family only floor" in Muslim-dominated neighborhoods of such as Chow Kit, Jalan Masjid India, and Jalan Tunku Abdul Rahman in Kuala Lumpur.

## HALAL FOOD PRODUCT SERVICES

Non-Muslim tourists said they prefer to stay in accommodations that welcome both vegetarian and non-vegetarian visitors and they have no issues consuming halal food because they think all halal food is hygienic. Besides, they do not mind halal food and can go without pork or alcohol if they need to comply with halal travel packages when traveling using halal travel packages.

## SATISFACTION

Some travelers who engage in halal tourism also believe that halal goods and services are more safe and more hygienic since they have the blessing of Islamic religious authorities also halal tourism participants claim that the hotels where they stay are reasonably priced because the proprietors conduct their operations in accordance with Islamic principles rather than merely looking to make a quick buck. Many non-Muslim tourists claim they have no problem staying in a hotel run by Muslims if they don't make any comments about their attire when using the hotel's pool or nearby beach. Additionally, they added that they always adhere to the belief that halal products should only be consumed since they do not have any negative health consequences and require special licensing from the relevant health authorities. Next, they stated that since Muslim-friendly hotels are less concerned with making a profit, they are a better option if they need a place to stay. Their main priority is always travelling affordably but comfortably.

## RESEARCH HYPOTHESIS

From the conceptual framework, an independent variable was being connection with halal tourism satisfaction. Based on the variable above, these hypotheses are defining as;

H1: There is relationship between banning non-halal services towards satisfaction

University Malaysia Kelantan student of halal tourism.

H2: There is relationship between general halal services towards satisfaction University



Malaysia Kelantan student of halal tourism.

H3: There is relationship between halal food product services towards satisfaction  
University Malaysia Kelantan student of halal tourism.

## RESEARCH FRAMEWORK

A study framework was established based on the literature evaluation to explore the link between satisfaction and the impact of tourists' perceptions on halal tourism destination. Figure 2.1 depicts the suggested conceptual framework, which includes the independent variables of banning non-halal services, general halal services, and halal food product services. The dependent variable is satisfaction.

### Independent Variables

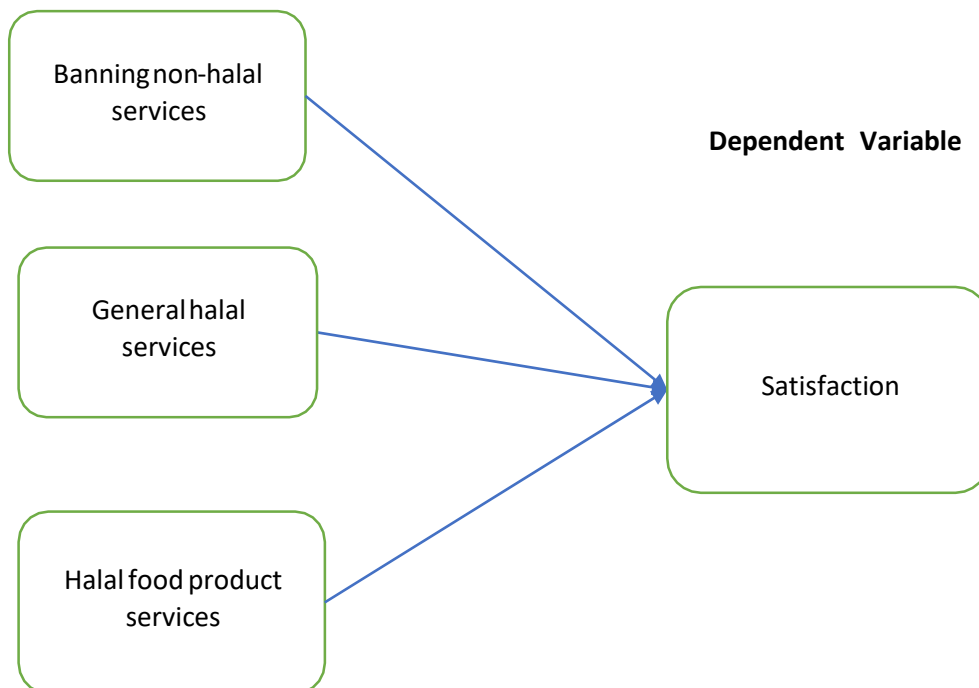

Figure 2.1: Conceptual Framework

## METHODOLOGY RESEARCH DESIGN

Research design is the framework for a researcher's techniques and methods, guiding them in developing appropriate research methods and creating successful studies. It determines the data needed for gathering, analyze, and assessing data, as well as testing hypotheses and evaluating programs. The research design identifies the problem, its scope, and context, addresses how people learn, needs, and why they need it, and includes a theoretical framework. A study design is an approach for employing empirical data to address an issue. Research designs can be categorized as descriptive, experimental, or mixed methods.

Quantitative methods use rigorous, objective, and systematic numerical data to define variables and investigate their relationships. This research uses questionnaires and Google Forms for quantitative data collection, which are standardized tools used for precise measurement and establishing cause and effect relationships between variables. Google Forms is a good choice for administering questionnaires due to its professional appearance and various formats, making it an effective tool for collecting data for research purposes.

A sample is a more limited set of participants chosen from the overall population of the study to make inferences about the target population. Additionally, if a sample is accurately representative, conclusions drawn from it can be applied to the full population. The study was conducted on several types of people who fit the study's design. This study used a sample of respondents from every possible area and had a total of 10 respondents.

This equation provided the sample's formula with a 95% confidence interval and a 5% level of significance.

The Formula for sample size:  $n = \frac{N}{1+N(e)^2} \dots \dots \dots (ii)$

- Where:
- n = Sample size to be studied
  - N = Population size
  - e = margin of error

The following formula provided, the sample size for this study :

$$n = \frac{57}{1 + 57(0.05)^2}$$

$$n = \frac{57}{1 + 0.1425}$$

$$n = \frac{57}{1.1425}$$

$$n = 49.89$$

The sample in this study is 50

From the formula above, the sample required for this study is fixed at 50 students which will focus on University Malaysia Kelantan students.

### **DATA COLLECTION**

This research uses the question method to obtain data from the survey questions given. This question method is very easy to use by simply answering a few questions given and submitting according to the procedure and relatively free from several types of error.

### **SAMPLING**

The quantitative study sampling method in this research is to obtain representative data of a small group from a large group. Quantitative research based on analysis in which statistical, mathematical and computational methods are used to analysis measurable or quantifiable data sets. Sampling strategy is a non-probability facility that is quick, easy, and affordable to use.

### **DATA ANALYSIS**

The researchers will analyze the primary data using (SPSS), SPSS is a statistical package for the social science. The generation of tables and pie charts is made possible by the program-based data analysis and processing window known as SPSS. Computers made it easier for academics to collect data and facilitate quantitative analysis. Utilizing Pearson's correlation, regression, reliability statistics, and descriptive statistics, the researcher assesses quantitative data.

## FINDINGS

**TABLE 1: DEMOGRAPHIC PROFILE**

		GENDE R	AGE	RACE S	EDUCATIO N BACKGRO UND	STATU S	TRAVEL PERIOD /
N	Valid	151	151	151	151	151	151
	Missin g	0	0	0	0	0	0
Mean		1.76	1.31	1.18	2.07	1.16	2.09
Std. Deviation		.428	.759	.578	.854	.385	.819

### 1.1 NUMBER OF RESPONDENT BASED ON GENDER

GENDER	FREQUENCY	PERCENTAGE	VALID PERCENT	CUMULATIVE PERCENT
MALE	36	23.8	23.8	23.8
FEMALE	115	76.2	76.2	100.0
TOTAL	151	100.0	100.0	

### 1.2 NUMBER OF RESPONDENT BASED ON AGE

AGE	FREQUENCY	PERCENTAGE	VALID PERCENT	CUMULATIVE PERCENT
20-25 YEARS OLD	125	82.8	82.8	82.8
26-30 YEARS OLD	11	7.3	7.3	90.1
31-35 YEARS OLD	9	6.0	6.0	96.0
OTHER	6	4.0	4.0	100.0
TOTAL	151	100.0	100.0	

### 1.3 NUMBER OF RESPONDENT BASED ON RACE

RACE	FREQUENCY	PERCENTAGE	VALID PERCENT	CUMULATIVE PERCENT
MALAY	135	89.4	89.4	89.4
INDIAN	8	5.3	5.3	94.7
CHINESE	5	3.3	3.3	98.0
OTHER	3	2.0	2.0	100.0
TOTAL	151	100.0	100.0	

### 1.4 NUMBER OF RESPONDENT BASED ON EDUCATION BACKGROUND

EDUCATION BACKGROUND	FREQUENCY	PERCENTAGE	VALID PERCENT	CUMULATIVE PERCENT
DIPLOMA	24	15.9	15.9	15.9
DEGREE	111	73.5	73.5	89.4
MASTER	6	4.0	4.0	93.4
PHD	2	1.3	1.3	94.7
OTHER	8	5.3	5.3	100.0
TOTAL	151	100.0	100.0	

### 1.5 NUMBER OF RESPONDENT BASED ON STATUS

STATUS	FREQUENCY	PERCENTAGE	VALID PERCENT	CUMULATIVE PERCENT
SINGLE	128	84.8	14.6	84.8
MARRIED	22	14.6	14.6	99.3
OTHER	1	7	7	100.0
TOTAL	151	100.0	100.0	

### 1.6 NUMBER OF RESPONDENT BASED ON TRAVEL PERIOD

TRAVEL PERIOD	FREQUENCY	PERCENTAGE	VALID PERCENT	CUMULATIVE PERCENT
PUBLIC HOLIDAY	43	28.5	28.5	28.5
SEMESTER BREAK / WEEKENDS	52	34.4	34.4	62.9
ANYTIME	55	36.4	36.4	99.3
OTHER	1	7	7	100.0
TOTAL	151	100.0	100.0	

### RANGE OF MEAN AND LEVEL OF AGREEMENT

Range of Mean	Level of Agree
4.51 – 5.00	Strongly Agree
3.51 – 4.50	Agree
2.51 – 3.50	Neutral
1.51 – 2.50	Disagree
1.0 – 1.50	Strongly Disagree

### Frequencies Statistics

		HALAL SERVICE IS VERY IMPORTANT TO ME WHEN TRAVELING	BANNING NON-HALAL SERVICES IS GOOD FOR SOCIETY	I AM HAPPY IF BANNING NON-HALAL SERVICES	NON-HALAL SERVICES ARE MUCH NEEDED FOR NON-MUSLIM
N	Valid	151	151	151	151
	Missing	0	0	0	0
	Mean	4.52	3.91	3.85	3.79

Std. Deviation	951	1.251	1.283	1.054
----------------	-----	-------	-------	-------

	Item Description	N	Mean	Level of Agreement
1	Halal Service is Very Important to Me When Travelling	151	4.52	Strongly Agree
2	Banning Non-Halal Services Is Good for Society	151	3.91	Agree
3	I Am Happy If Banning Non-Halal Services	151	3.85	Agree
4	Non-Halal Services Are Much Needed for Non-Muslim	151	3.79	Agree
Average Mean		151	3.97	Agree

### Statistics

		I STRONGLY EMPHASIZE HALAL SERVICES	HALAL SERVICES ARE VERY IMPORTANT FOR EVERYONE	HALAL SERVICES ARE ONLY IMPORTANT TO MUSLIMS	GENERAL HALAL SERVICES PLAY AN IMPORTANT ROLE TO EVERY TOURIST
N	Valid	151	151	151	151
	Missing	0	0	0	0
Mean		4.52	4.37	3.37	4.23
Std. Deviation		.871	.921	1.350	.927

### General Halal Services

No.	Item Description	N	Mean	Level of Agreement
1	I Strongly Emphasize Halal Services	151	4.52	Strongly Agree

2	Halal Services Are Very Important for Everyone	151	4.37	Agree
3	Halal Services Are Only Important to Muslim	151	3.37	Neutral
4	General Halal Services Play an Important Role to Every Tourist	151	4.23	Agree
	Average Mean		4.12	Agree

### Statistics

		HALAL FOOD IS VERY IMPORTANT IN MY LIFE	HALAL FOOD AND DRINKS ARE AVAILABLE IN EVERY HOTEL	HALAL FOOD AND DRINKS CAN BE FOUND IN HOTELS AND MALLS	FREE ALCOHOLIC BEVERAGES HAVE BEEN PROHIBITED BY THE AUTHORITIES IN THE HOTEL
N	Valid	151	151	151	151
	Missing	0	0	0	0
Mean		4.50	4.16	4.33	4.16
Std. Deviation		1.012	1.065	.957	.932

### Halal Food Product Services

No.	Item Description	N	Mean	Level of Agreement
1	Halal Food Is Very Important in My Life	151	4.50	Strongly Agree



2	Halal Food and Drinks Are Available in Every Hotel	151	4.16	Agree
3	Halal Food Can Be Found in Hotels and Malls	151	4.33	Agree
4	Alcoholic Beverages Have Been Prohibited by The Authorities in The Hotel	151	4.16	Agree
Average Mean		151	4.29	Agree

### Statistics

		I AM SATISFIED WITH THE FACILITIES PROVIDED IN THE HOTEL	I AM SATISFIED WITH HALAL SERVICES ON TOURISM SITE	I AM SATISFIED WITH THE RULES ON THE TOURIST SITE	I AM SATISFIED TO SEE A CLEAN AND TIDY HOTEL
N	Valid	151	151	151	151
	Missing	0	0	0	0
Mean		4.07	4.23	4.12	4.44
Std. Deviation		1.011	.920	.959	.928

**TABLE 2: DESCRIPTIVE ANALYSIS STATISTIC OF SATISFACTION TOWARDS HALAL TOURISM**

No.	Item Description	N	Mean	Level of Agreement
1	I Am Satisfied with The Facilities Provided in The Hotel	151	4.07	Agree
2	I Am Satisfied with Halal Services on Tourism Site	151	4.23	Agree
3	I Am Satisfied with The Rules on The Tourist Site	151	4.12	Agree
4	I Am Satisfied to See a Clean and Tidy Hotel	151	4.44	Agree

Average Mean	151	4.22	Agree
--------------	-----	------	-------

**TABLE 3: RELIABILITY ANALYSIS**

Cronbach's Alpha	Level of Reliability
$\alpha \geq 0.9$	Excellent
$0.9 > \alpha \geq 0.8$	Good
$0.8 > \alpha \geq 0.7$	Acceptable
$0.7 > \alpha \geq 0.6$	Questionable
$0.6 > \alpha \geq 0.5$	Poor
$0.5 > \alpha$	Unacceptable

Cronbach Alpha Coefficient Values (Rule of Thumb for Result)

Strength Interval of Correlation Coefficient

Cronbach's Alpha	The Strength
$\alpha \geq 0.9$	Excellent
$0.9 > \alpha \geq 0.8$	Good
$0.8 > \alpha \geq 0.7$	Acceptable
$0.7 > \alpha \geq 0.6$	Questionable
$0.6 > \alpha \geq 0.5$	Poor
$0.5 > \alpha$	Unacceptable

Cronbach Alpha Coefficient Values (Rule of Thumb for Result)

## TABLE 4: PEARSON CORRELATION ANALYSIS

Table 4.7.1 shows the results of the relation between three factors.

		M_IV1	M_IV2	M_IV3	M_DV4
M_IV1	Pearson Correlation	1	.718**	.505**	.609**
	Sig. (2-tailed)		.000	.000	.000
	N	151	151	151	151
M_IV2	Pearson Correlation	.718**	1	.647**	.661**
	Sig. (2-tailed)	.000		.000	.000
	N	151	151	151	151
M_IV3	Pearson Correlation	.505**	.647**	1	.746**
	Sig. (2-tailed)	.000	.000		.000
	N	151	151	151	151
M_DV4	Pearson Correlation	.609**	.661**	.746**	1
	Sig. (2-tailed)	.000	.000	.000	
	N	151	151	151	151

### Hypothesis 1: Relationship between banning non-halal services towards satisfaction of halal tourism.

Table 4.7.1 displays the Pearson correlation coefficient, significant value, and number of answers (151) based on the Pearson correlation coefficient. As a consequence of the analysis, hypothesis 1 is accepted. Pearson correlation 0.661 indicates a substantial link between positive level. This demonstrates that independent variable 1 influences 66.1% of the dependent variable (satisfaction towards halal tourism). H1, which was developed to assess the association between banning non-halal services and satisfaction, is acceptable.

### Hypothesis 2: Relationship between general halal services towards satisfaction of halal tourism.

Table 4.7.1 displays the Pearson correlation coefficient, significant value, and number of answers (151) based on the Pearson correlation coefficient. As a consequence of the analysis, hypothesis 1 is accepted. Pearson correlation 0.746 indicates a substantial link between positive level. This demonstrates that independent variable 1 influences 74.6% of the dependent variable (satisfaction towards halal tourism). H2, which was developed to assess the association between banning non-halal services and satisfaction, is acceptable.

### Hypothesis 3: Relationship between halal food product services towards satisfaction of halal tourism.

Table 4.7.1 displays the Pearson correlation coefficient, significant value, and number of answers (151) based on the Pearson correlation coefficient. As a consequence of the analysis, hypothesis 1 is accepted. Pearson correlation 0.609 indicates a substantial link between positive level. This demonstrates that independent variable 1 influences 60.9% of the dependent variable (satisfaction towards halal tourism). H3, which was developed to assess the association between banning non-halal services and satisfaction, is acceptable.

Result: There was a link between hypotheses 1, 2, and 3 and halal tourism satisfaction. Hypothesis 1, 2 and 3 are the independent and dependent variables in this hypothesis, respectively.

## DISCUSSION AND RECOMMENDATION

Figure 4.8 shows the data values for the significant independent variables to the dependent variable. The dependent variable, satisfaction, showed a significant relationship with three independent variables: Banning non-halal services, General halal services, and Halal food product services. Among these independent variables, banning non-halal services have the highest Pearson correlation value of 1.00. The Pearson correlation value for General Halal services is 0.718, which is the second highest. Meanwhile, the Pearson correlation value for Halal Food Product is 0.505. As a consequence, banning non-halal services, General halal services, and Halal food product services are three separate elements that have a connection with satisfaction. However, the correlation between the dependent and independent variables is only moderate since the strength of the correlation between them is modest.

## CONCLUSION

In conclusion, this study was conducted to learn more about the elements that affect tourist satisfaction. In addition, this study can be used as a reference by other academics who conduct research on halal tourism. The results obtained in Chapter 4 using the Statistical Package for the Social Sciences (SPSS) were further explored, and inferences were made as a result of the findings. So, it can be concluded that banning non-halal services, general halal services and halal food product services have a moderate effect on tourist satisfaction.

## REFERENCES

- Akter, M., Sadekin, M. N., & Patwary, A. K. (2020). An Empirical Study on Students' Satisfaction from Mawlana Bhashani Science & Technology University, Bangladesh. *Review of Economics and Development Studies*, 6(2), 363-379.
- Alom, S., Patwary, A. K., & Khan, M. M. H. (2019). Factors affecting the turnover intention of Bangladeshi migrants in the United Arab Emirates: An empirical study on the hotel industry. *International Journal of Innovation, Creativity and Change*, 8(3), 344-360.
- Azali, M., Kamal Basha, N., Chang, Y. S., Lim, X. J., & Cheah, J. H. (2023). Why not travel to Malaysia? Variations in inbound tourists' perceptions toward Halal-friendly destination attributes. *Journal of Hospitality & Tourism Research*, 47(1), 177-206.

- De Boer, A., Pijl, S. J., & Minnaert, A. (2011). Regular primary schoolteachers' attitudes towards inclusive education: A review of the literature. *International journal of inclusive education*, 15(3), 331-353.
- Dealwis, C., Johari, A., & Morni, A. (2022, September). The Perception of Non-Muslim Tourists towards Halal Tourism: A Case Study in Kuching, Sarawak. In *Proceedings Borneo Islamic International Conference eISSN 2948-5045 (Vol. 13, pp.01-12)*.
- Fajriyati, I., Afiff, A. Z., Gayatri, G., & Hati, S. R. H. (2020). Generic and Islamic attributes for non-Muslim majority destinations: application of the three-factor theory of customer satisfaction. *Heliyon*, 6(6), e04324.
- Fengmin, Z., Baijun, W., Jiangtao, B., Li, L., & Patwary, A. K. (2022). Investigating revisit intention of medical tourists in China through nutritional knowledge, perceived medical quality, and trust in the physiologist: A recommendation on health tourism policy measures. *Frontiers in Public Health*, 10, 893497.
- Hazbar, A. M. H., Alem Mohammed, A., & Karim, A. K. A. (2019). An Empirical Study of Factors Influencing hotel customers' online booking Intention. *مجلة العلوم التربوية و الدراسات الإنسانية*, (5), 1-17.
- Imai, K., King, G., & Lau, O. (2009). Zelig: Everyone's statistical software. R package version, 3(5).
- Li, L., Ragavan, N. A., Patwary, A. K., & Baijun, W. (2022). Measuring patients' satisfaction toward health tourism in Malaysia through hospital environment, nutritional advice, and perceived value: A study on Chinese exchange students. *Frontiers in public health*, 10, 893439.
- Li, L., Wu, B., & Patwary, A. K. (2022). How marine tourism promote financial development in sustainable economy: new evidences from South Asia and implications to future tourism students. *Environmental Science and Pollution Research*, 29, 1155-1172.
- Li, L., Wu, B., & Patwary, A. K. (2022). The psychosocial factors affecting chinese Outbound Exchange and mobility students' academic performance during COVID-19. *Frontiers in psychology*, 13, 872516.
- Nasir, M. N. M., & Wongchestha, N. (2022). Parallel Mediators of Place Attachment and Tourist Motivation in Involvement and Destination Loyalty: A Conceptual Model. *International Journal of Hospitality & Tourism Systems*, 15(2), 103-105.
- Patwary, A. K., Roy, B., Hoque, R., & Khandakar, M. S. A. (2019). Process of developing a community based tourism and identifying its economic and social impacts: An Empirical study on Cox's Bazar, Bangladesh. *Pakistan Journal of Humanities and Social Sciences*, 7(1), 1-13.
- Sumethokula, P., Patwary, A. K., Srinuanpanc, B., Srinuanpand, C., Suwandee, P., Thammathikul, A., & Phanong, W. (2020). The potential of new tour repackaging for creative tourism among entrepreneurs in Nakhon Si Thammarat. *International Journal of Innovation, Creativity and Change*, 13(10), 1752-1771.
- Vargas-Sánchez, A., & Moral-Moral, M. (2019). Halal tourism: literature review and experts' view. *Journal of Islamic Marketing*
- Wu, B., Liu, S., Wang, J., Tahir, S., & Patwary, A. K. (2021). Assessing the mechanism of energy efficiency and energy poverty alleviation based on environmental regulation policy measures. *Environmental Science and Pollution Research*, 28, 40858-40870.

Wu, B., Zhai, B., Mu, H., Peng, X., Wang, C., & Patwary, A. K. (2021). Evaluating an economic application of renewable generated hydrogen: A way forward for green economic performance and policy measures. *Environmental Science and Pollution Research*, 1-15.

# **The Effectiveness of Technology Use Among Tourist Satisfaction in Kelantan**

**Noor Atirrah Binti Anuar (h20a1353), Noor Shafawani Binti Nordin (h20a1357),  
Noor Syamimi Binti Mohd Noor (h20a1360), Noorshahida Binti Abdullah (h20a1365)  
(\* Dr. Mohanad S. S. Abumandil \*)**

*Faculty of Hospitality, Tourism and Wellness, Universiti Malaysia Kelantan*

*Corresponding email: h20a1353@siswa.umk.edu.my, h20a1357@siswa.umk.edu.my,*

*h20a1360@siswa.umk.edu.my, h20a1365@siswa.umk.edu.my*

## **ABSTRACT**

*The text highlights the importance of advanced technologies in the travel and tourism sector, emphasizing their role in improving customer experience and operational efficiency. It mentions that technology can help companies reduce costs, increase revenue, and enhance financial outcomes. The use of technology in the industry can also provide convenience, safety, and fewer touch points for travellers, especially in the context of the COVID-19 pandemic. The concept of "revenge travel" is introduced, referring to the pent-up desire for travel after a period of restrictions. The text also mentions the significance of ensuring traveller security in travel plans. The effectiveness of technology use in Kelantan, Malaysia, is discussed, highlighting its impact on tourist satisfaction and the rapid growth of the country's economy. The research methodology is briefly outlined, including the use of a quantitative study, probability or random sampling technique, and online questionnaire surveys for data collection.*

**Keywords:** *Technology, Tourist Satisfaction, Kelantan, ICT*

## **INTRODUCTION**

The text highlights the increasing reliance of tourists on technology in various aspects of travel and the potential impact it has on tourist satisfaction in Kelantan, Malaysia. While previous studies have demonstrated the positive effects of technology on communication and convenience in the tourism industry, research specifically focused on the relationship between technology use and tourist satisfaction in Kelantan is limited. To address this gap, the study aims to examine the effectiveness of technology use in enhancing tourist satisfaction in the region. The study will investigate the type, frequency, and purpose of technology use as independent variables, while tourist satisfaction will serve as the dependent variable, measured through surveys or interviews. The findings of the study will provide valuable insights for tourism stakeholders in Kelantan on how to effectively leverage technology to improve the overall tourist experience.

### **Significance of the Study**

This study on the effectiveness of technology use among tourist satisfaction in Kelantan, Malaysia has several significant implications. Firstly, it provides valuable insights for tourism stakeholders, helping them understand how technology can enhance the tourist experience and attract more visitors to the region. Secondly, it contributes to the sustainable expansion of the tourism sector by exploring how technology can promote sustainable tourism practices. Thirdly, the study aims to understand technology use among different types of tourists, enabling tailored services for specific segments. Lastly, it adds to the existing literature on technology use and tourist satisfaction, expanding knowledge in this field and setting the foundation for further research.

Overall, this study is important for improving the tourism experience in Kelantan and supporting the sustainable development of the tourism industry.

## **LITERATURE REVIEW**

The literature review for chapter 2 of the research study on "The effectiveness of technology use among tourist satisfaction in Kelantan" examines the different types of technology commonly used in the tourism industry, such as online booking systems, mobile applications, and social media. Studies have shown that technology positively affects visitor satisfaction. For instance, research by Li and Petrick (2018) indicates that online booking systems enhance the booking process and increase satisfaction. Similarly, Wang and Wang (2019) found that mobile applications provide convenience and control, resulting in higher satisfaction levels.



Moreover, the indirect impact of technology on satisfaction through trust and perceived risk is explored. Wang and Wang (2019) discovered that technology usage increases trust in tourist destinations, leading to greater satisfaction. Similarly, Kim and Lee (2018) noted that technology reduces perceived risk during travel decision-making, ultimately enhancing satisfaction. However, challenges associated with technology use in the tourism industry are also discussed. Mohd et al. (2020) revealed limitations in the use of technology in Kelantan, Malaysia, emphasizing the need for improved availability and accessibility. Additionally, Wang and Wang (2019) highlighted the potential issue of information overload caused by technology, which may decrease satisfaction.

Overall, the literature review emphasizes the positive impact of technology on tourist satisfaction but acknowledges the importance of considering context and challenges specific to the tourism industry. It calls for further research on the use of technology in Kelantan and its effects on tourist satisfaction.

### **Type Of Technology Use**

The Internet of Things (IOT) is a sort of technology that can be utilised to increase tourist pleasure. This is due to the Internet of Things, which involves the interconnection of common household gadgets based on the Internet and enables them to send and receive data. This is one of the most interesting emerging concepts in travel technology.

To improve tourist satisfaction, Kelantan can make use of information and communication technology (ICT). Thanks to ICT, travellers may readily look up and compare travel-related products on demand. The internet is often regarded as the most common and effective form of communication. People from all around the world can communicate through written, voice, and video messaging thanks to it. Users of the internet can trade information and communicate practically instantly. This makes it an effective tool for organisations, causes, institutions, and people. The internet has changed the ways in which services are provided to customers.

Virtual reality has gained popularity across several businesses, but its impact on the tourism industry is particularly remarkable. Kelantan should take use of this technology in the future. The ability to research distant locales from the comfort of one's home is made possible by technology, which may influence a traveller's decision to book a reservation or not. Virtual tours are available for everything from hotels and eateries to famous landmarks, national parks, and even individual locations.

In the tourism sector, mobile technology is a key enabler of M-Commerce. For PDA-based systems and mobile information systems, tourism has been a prominent industry. In fact, one obvious application area for mobile phones and other portable gadgets is tourism. M-commerce is thus a limited form of business. Consumers profit from mobile communications because M-commerce allows for both the extension of the advantages of the Web and the creation of special services made possible by the integration of the Internet and mobile technology. Mobile gadgets like smartphones, notepads, and cell phones offer non-location-based information access as well as potential new communication channels.

### **Frequency Of Technology Use**

Large-scale analyses of technology use frequently emphasize on reported frequency, typically the period spent using digital technology, under the presumption that it is possible to determine the frequency of digital technology use. The frequency of use recorded, such as "No time," "1-30 minutes a day," or "greater than 6 hours a day," is typically used to assess time (OECD, 2017). Such scales, however, frequently fall short when attempting to quantify brief but intense periods of technology use, and they also neglect to account for the effectiveness of that time.

Tourists have a wealth of knowledge. To choose the best holiday for them, they search for various tools that are useful for everyone. Businesses in the tourism industry need to put in place an effective customer system on the app, and the app can respond to all material, give personalised services, and provide ease by staying up to date with technological advancements. Using social media is one of the most effective and convenient travel technology. Making engaging material is one strategy for utilising social networks. Social network user recommendations can serve as "Digital Referrals" and influence many of their followers to visit that business.

Outsourcing software development services may be necessary when developing new technology-driven tourism products. The system also helps with the primary objective of enhancing the customer's overall experience with the brand, from their booking to their stay to the administration of evaluations they might typically leave only once. This clearly shows how often tourists will use technology as their intermediary to get all the information they want in the travel survey they will do. The technology introduced in tourism makes it easier for many parties to communicate with foreign tourists coming to Kelantan.

## **Purpose Of Technology Use**

Using technology is meant to improve productivity, efficiency, and quality of life for people. Technology is the umbrella term covering the devices, methods, and procedures utilised to produce, store, and share data and information. Almost every element of contemporary life has been altered using technology, from communication and transportation to healthcare and entertainment. For instance, the ability to analyse massive volumes of data rapidly and precisely thanks to computers and software has improved work in industries like banking, commerce, and scientific research (Timothy Bresnahan, 2010). The ability to instantaneously contact with individuals anywhere in the globe thanks to the internet and mobile technology has completely changed how we interact with one another and conduct business.

Tourism stakeholders in Kelantan may use technology to sell their goods and services, enhance tourist interaction, and reduce administrative procedures (Ishwar Khatri, 2019) more effectively. Creating digital marketing plans is one of the main ways technologies is being used in Kelantan tourism. Tourist organisations and companies in Kelantan are using social media sites like Facebook, Instagram, and Twitter to market their services and reach a bigger audience. Moreover, they are utilising search engine optimisation (SEO) strategies to raise their online presence and increase website traffic.

## **Tourist Satisfaction**

Tourist satisfaction is an important aspect of the tourism industry as it plays a crucial role in the success of destinations and businesses. Satisfaction refers to the positive evaluation of one's experience in a particular setting or activity, and in the case of tourism, it relates to the perceived quality of various aspects such as accommodation, food and beverage, attractions, transportation, and overall destination experience (Chen & Tsai, 2011). Moreover, Nasir et al. (2023) claimed that satisfaction is occurred when tourists perceptions exceed their initial expectations which cause them to feel satisfy using tourism products and services in a certain destination.

In the context of Kelantan, a state in Malaysia known for its rich cultural heritage and natural attractions, understanding tourist satisfaction is crucial for the growth and sustainability of the tourism industry. With the increasing use of technology in the tourism sector, it is important to examine how technology use affects tourist satisfaction. Technology use refers to the use of various digital tools

and platforms, such as websites, social media, mobile apps, and information kiosks, to enhance the tourist experience and facilitate communication and information sharing (Buhalis & Law, 2008).

Therefore, the present study aims to investigate the effectiveness of technology use among tourist satisfaction in Kelantan. Specifically, the study will explore the extent to which technology use, such as mobile apps and social media, contributes to tourist satisfaction in the state. By doing so, the study aims to provide insights into the role of technology in enhancing tourist satisfaction, which can inform tourism stakeholders and policy makers in developing effective strategies to improve the quality of tourism services and facilities in Kelantan.

### **Research Hypothesis**

A hypothesis is a statement or prediction about the relationship between variables that can be tested through research. In the context of this research study, "The effectiveness of technology use among tourist satisfaction in Kelantan," the hypotheses are statements about the relationship between the use of technology in the tourism industry and tourist satisfaction in Kelantan. These hypotheses can guide the research by providing a framework for the data collection and analysis and help to identify the specific research questions that need to be answered.

#### **Hypothesis 1**

The use of technology in the tourism industry will have a favorable effect on tourist satisfaction in Kelantan.

#### **Hypothesis 2**

The use of online booking systems will have a greater impact on tourist satisfaction than the use of mobile applications or social media in Kelantan.

#### **Hypothesis 3**

The use of technology in the tourism industry will have a positive impact on trust and a negative impact on perceived risk in Kelantan, which in turn will lead to increased tourist satisfaction

The researcher typically proposes hypotheses based on their knowledge of the subject, the body of existing literature, and their expectations. These hypotheses then need to be evaluated and confirmed using actual data and research findings.

## Research Framework

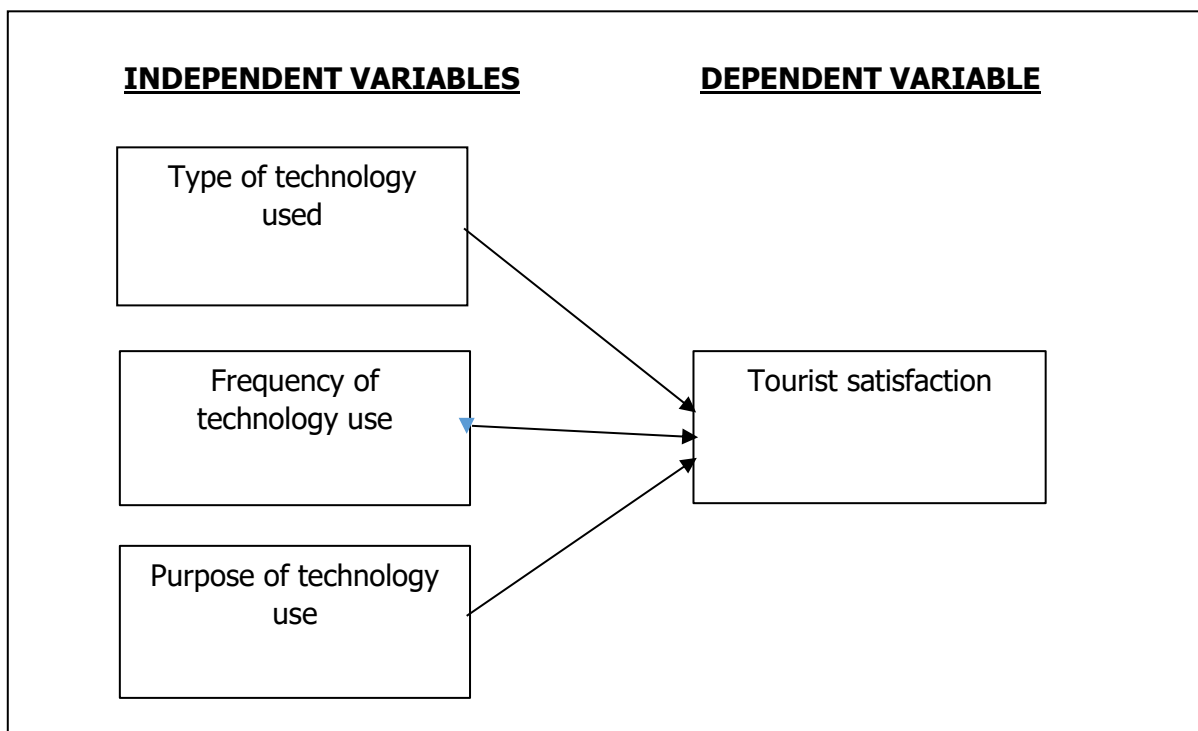

## METHODOLOGY

### Research Design

The survey will gather information on technology use for trip planning and during the trip, as well as satisfaction with various aspects of the trip. Demographic questions will also be included to explore differences in the relationship between technology use and satisfaction among different tourist subgroups. Descriptive statistics will be used to summarize the data, and inferential statistics will be used to evaluate hypotheses. Pearson's correlation and multiple regression analysis will specifically be employed to investigate the relationship between technology use and satisfaction. To ensure the study's validity and reliability, the survey instrument will undergo pre-testing and pilot testing. Additionally, the collected data will be carefully cleaned and checked for missing or inconsistent values.

### Data Collection

This study will employ a self-administered questionnaire method to collect data on the effectiveness of technology use among tourist satisfaction in Kelantan. The questionnaires will be distributed to tourists visiting Kelantan in places such as hotels, restaurants, and tourist attractions. The questionnaires will consist of closed-ended questions, which will allow for quantitative data

collection. The data will be analysed using descriptive and inferential statistics to summarize the data, identify trends, test hypotheses, and generate new hypotheses. To ensure the accuracy and reliability of the data, the questionnaires will be pre-tested for clarity, and revisions will be made as necessary. The data collection process will be conducted systematically and controlled, with data being gathered over a few weeks to ensure an adequate sample size.

## **Sampling**

This study will utilize a convenience sampling method, which involves selecting participants based on their accessibility and willingness to participate. The target audience for this study will be visitors to Kelantan. The sample size for the study will be determined using a sample size calculator, considering factors such as the population size, desired degree of confidence, and margin of error. To determine the minimal sample size needed, the sample size calculator will be employed. Based on the population of visitors to Kelantan, a sample size of 238 individuals will be chosen. The selected participants will be provided with self-administered questionnaires to collect the necessary data.

In summary, this study will utilize convenience sampling to select participants who are accessible and willing to participate. The sample size will be determined using a sample size calculator, with a target of 238 individuals. Data collection will be conducted through the distribution of self-administered questionnaires to the selected sample

## **Data Analysis**

Data analysis is an essential aspect of any research study as it helps in interpreting the collected data and drawing meaningful conclusions from it. First, descriptive statistics such as frequency distributions, mean, median, and standard deviation will be used to summarize the data and provide a general overview of the population's characteristics and responses. This will help in understanding the demographic profile of the participants. Next, inferential statistics will be used to test the hypotheses and research questions formulated in the study.

Correlation and regression analyses will be used to examine the relationship between the independent variables and the dependent variable. These analyses will help in determining the extent to which technology use influences tourist satisfaction in Kelantan. Additionally, chi-square tests will be employed to determine the significance of the differences in responses between different subgroups of participants, such as gender, age, and education level. This will help in identifying any potential

bias or variations in the responses based on these demographic factors. Overall, the data analysis will provide insights into the effectiveness of technology use among tourists in Kelantan and its impact on their satisfaction levels.

## FINDINGS

### Demographic Analysis

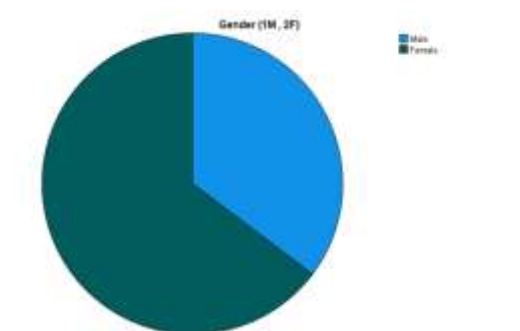

The table above displays the frequency and percentage of respondents by gender. 238 people responded to this quiz and provided responses. There were 158 of them, or 64.7% of the total, who were female. 54 responders were men, or 35.3% of the total, making up the total. According to these findings, there were more female respondents than male respondents.

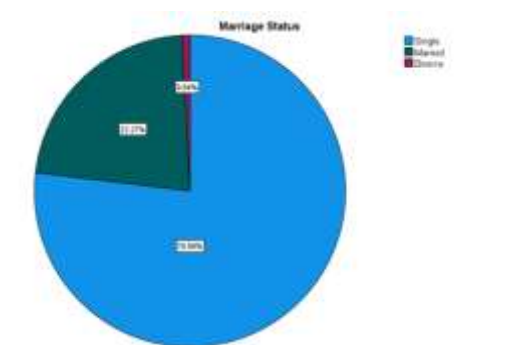

The age range of each responder who filled out our questionnaire is represented in this table. All respondents' marital status was separated into 3 categories. You can be single, married, or divorced. The largest group had 183 respondents (76.9%) who identified as single. Following that, 53 (22.3%) of the respondents to the questions about marriage and 2 (0.8%) of the responders to the questions about divorce completed them.

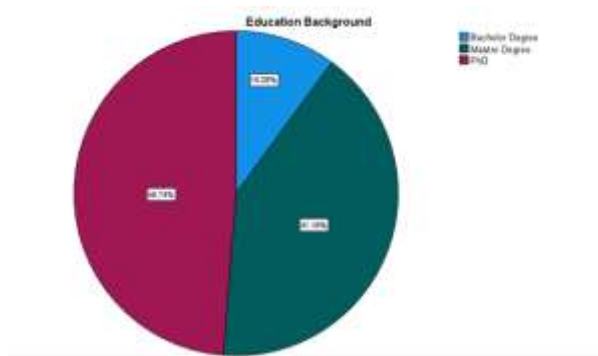

This table displays the respondents' educational backgrounds who responded to our survey. Of those surveyed, 24 (10.1%) had a bachelor's degree. The next group of respondents, 98 (41.2%) had a master's degree. This group responded to the survey with the second-highest average level of education. Finally, 116 PhD holders completed the questionnaire which is (48.7%).

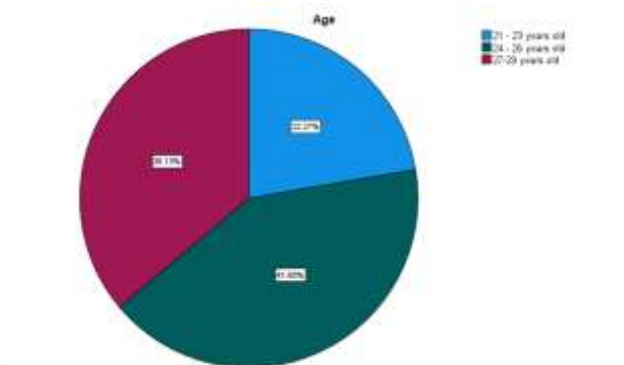

Age groups for each respondent. 53 (22.3%) of the people surveyed identified as being between the ages of 21 and 23. Following that, 99 (41.6%) of those surveyed were between the ages of 24 and (36. 86%) people between the ages of 27 and 29 then answered this questionnaire. They made up (36.1%) of the entire.



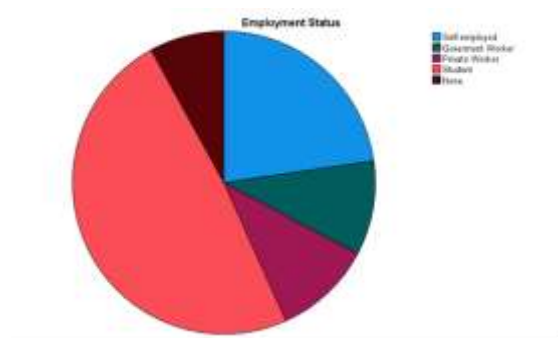

The jobs held by each respondent who completed this survey. Of those surveyed, 54 (22.3%) were self-employed. This group answered the questionnaire in the second-highest number. After then, 24 (10.1%) of the interviewees identified as government employees. 25 respondents, or 10.5% of all respondents, identified themselves as private workers. The questionnaire was then completed by 116 (48.7%) students in total. This group had the highest likelihood of completing the survey. Lastly, 19 respondents (8.0%) were identified as unemployment / none.

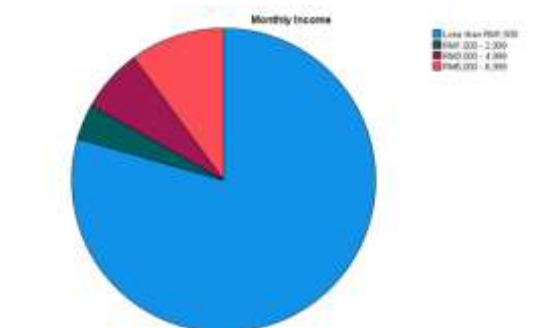

The monthly income ranges for each respondent. 189 people were interviewed in total, or (79.4%), had incomes under RM1,500. In terms of the total number of questionnaires, this is also the largest category. After that, 9 (3.8%) of the respondents said they made between RM1,500 and RM2,999 each month. Furthermore, 16 respondents (6.7%) stated that their monthly salary was between RM3,000 and RM4,999. Finally, 9 (3.8%) of the respondents reported monthly earnings of RM5,000–6,999. These numbers demonstrate that the respondents who filled out the survey were evenly dispersed across a range of income levels.

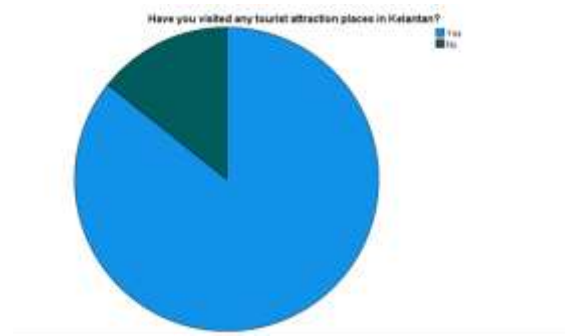

This table lists the respondents who completed our survey and have visited any Kelantan, Malaysia, tourist attractions. This question merely asks for a yes or no response to determine whether respondents have been to any Kelantan tourism attractions. While as you can see, 204 out of the total respondents indicated a yes response (85.7%), while 34 out of the total respondents indicated a no response (14.3%).

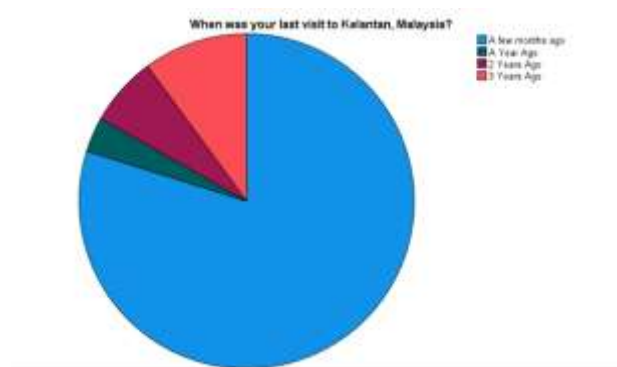

The table lists the respondents to the question, "When was your last visit to Kelantan, Malaysia?" A total of 190 people were interviewed at the time (79.8%). In terms of the total number of questionnaires, this is also the largest category. Following that, 8 (3.4%) of the respondents stated that they had last visited Kelantan, Malaysia, a year prior. In addition, 16 respondents (6.7%) said they have visited Kelantan, Malaysia, within the previous two years or more. The last time 24 respondents (10.1%) visited Kelantan, Malaysia, was three years ago or more. According to these figures, respondents last travelled to Malaysia's Kelantan.

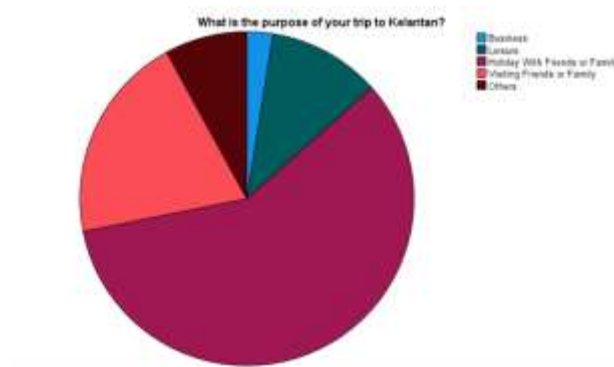

The frequency and proportion of respondents who stated "to visit Kelantan" are displayed in the table above. 238 people responded to this quiz and provided responses. 6 of them, or 2.5% of the total, were businesses. Meanwhile, around 26 respondents (10.9%) were choosing leisure time as their purpose to visit Kelantan. There were 139 (58.4%) vacations spent with friends or family. Additionally, 48 of them (20.2%) were on a visit to friends or family, while the other 19 respondents (8.0%) were elsewhere. This statistic reveals to the respondent why you are visiting Kelantan.

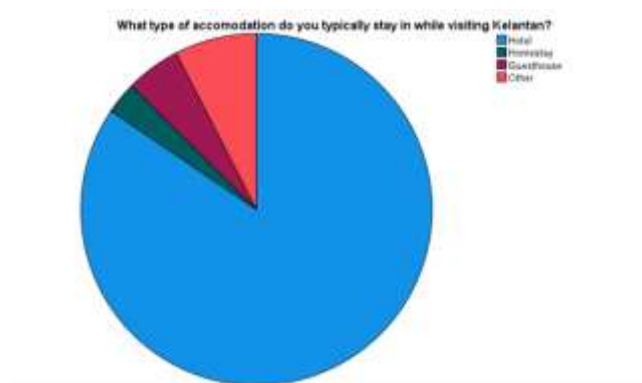

Table of these statistics displays the respondents who normally stay when travelling to Kelantan. Of the people surveyed, 201 (84.5%) were present at the hotel. In terms of the total number of questionnaires, this is also the largest category. Then, 7 (2.9%) of the respondents said they had stayed at a homestay. Furthermore, 12 responders (5.0%) stated that they were also recorded for guesthouses. Finally, 18 respondents (7.6%) reported that respondents stayed somewhere else.

## Descriptive Analysis

### Descriptive Analysis Statistic of Types of Technology Use

<b>Item Description</b>	<b>N</b>	<b>Mean</b>	<b>Std. Deviation</b>
Do you agree with the effectiveness of the use of this technology being expanded in Kelantan?	238	4.5378	.65975
The service provided through this technology is very helpful to you.	238	4.3613	.75452
Do you agree that mobile technology can expand further in Kelantan?	238	4.4538	.69048
The use of this technology should be expanded in hotels and any places in Kelantan.	238	4.5084	.67967
The use of IOT technology in hotel rooms can affect tourist satisfaction in Kelantan.	238	4.2017	.95095

This table shows the Descriptive Analysis Statistics of Types of Technology Use. The item with the greatest meaning was with the effectiveness of the use of this technology being expanded in Kelantan.' It had a 4.5378 mean, which is on the agreeable scale. The question with the second highest average, again at the level of agreement, was 'The service provided through this technology is very helpful to you' with a mean of 4.4538. The remaining questions for this independent variable, according to the data in the table, are at the neutral level. The highest result is 4.4538 and the question is do you agree that mobile technology can expand further in Kelantan? Following that means that the use of this technology should be expanded in hotels and any places in Kelantan is 4.5084. Finally, the mean for the use of IOT technology in hotel rooms can affect tourist satisfaction in Kelantan was 4.2017.

Descriptive Analysis Statistic of Frequency of Technology Use

<b>Item Description</b>	<b>N</b>	<b>Mean</b>	<b>Std. Deviation</b>
The use of technology can increase productivity and gain a competitive advantage in the market.	238	4.4790	.70380
Adapting to adopt technology and digitalization rapidly, communication, marketing, and promotion can advance the attractive tourism sector in Kelantan.	238	4.3782	.69345
The frequency of use of digital technology can increase the sustainability of tourism products and improve the delivery of existing services.	238	4.4664	.67889
Technology is used as an easy platform to find information and attract tourists to travel.	238	4.5840	.63585
The increasingly frequent use of digital technology in tourism can benefit the tourism sector in Kelantan.	238	4.5000	.64794

This table shows the Descriptive Analysis Statistic of Frequency of Technology Use. The item with the greatest meaning was the use of technology can increase productivity and gain a competitive advantage in the market. It had a 4.4790 mean, which is on the agreeable scale. The question with the second highest average, again at the level of agreement, was adapting to adopt technology and digitalization rapidly, communication, marketing and promotion can advance the attractive tourism sector in Kelantan with a mean of 4.3782. The remaining questions for this independent variable,

according to the data in the table, are at the neutral level. The highest result is 4.5840 for the statement Technology used as an easy platform to find information and attract tourists to travel. Following that, the frequency of use of digital technology can increase the sustainability of tourism products and improve the delivery of existing services is 4.4664. Finally, the mean for the increasingly frequent use of digital technology in tourism can benefit the tourism sector in Kelantan was 4.5000.

#### Descriptive Analysis Statistic of Purpose of Technology Use

<b>Items Description</b>	<b>N</b>	<b>Mean</b>	<b>Std Deviation</b>
The main purpose of technology in the field of tourism is to make things easier for tourists in Kelantan?	238	4.5084	.67967
The purpose of technology is to improve tourism convenience and the overall travel experience for travellers.	238	4.4160	.67449
The purpose of technology is also to coordinate and improve the booking process for travellers in the tourism industry to make it easier and more efficient.	238	4.4412	.69561
Applications such as Waze, Instagram and Facebook are examples of how technology is used to promote sustainable tourism practices, such as through smart destination management.	238	4.4874	.69191
The purpose of technology is used to promote cultural preservation and heritage tourism, such as through digital archives, virtual museums, and language translation tools, to	238	4.4916	.70407

help travellers better understand and appreciate local culture and traditions such as in Kelantan.			
--	--	--	--

This table shows the Descriptive Analysis Statistics of purpose of Technology Use. The item with the greatest mean was the main purpose of technology in the field of tourism is to make things easier for tourists in Kelantan It had a 4.5084 mean, which is on the agreeable scale. The purpose of technology is to improve tourism convenience and the overall experience for travellers with a mean 4.4160. The purpose of technology is also to coordinate and improve the booking process for travellers in the tourism industry to make it easier and more efficient with a mean of 4.4412. Applications such as Waze, Instagram and Facebook are examples of how technology is used to promote sustainable tourism practices, such as through smart destination management with a mean of 4.4874. The remaining questions for this independent variable, according to the data in the table, are at the neutral level. The second highest result is 4.4916 for the purpose of technology being used to promote cultural preservation and heritage tourism, such as through digital archives, virtual museums, and language translation tools, to help travellers better understand and appreciate local culture and traditions such as in Kelantan.

#### Descriptive Analysis Statistic of Tourist Satisfaction

Items Description	N	Mean	Std Deviation

The use of technology during my visit to Kelantan enhanced my overall tourist experience.	238	4.5252	.67301
The availability of technology in Kelantan helped me plan my itinerary more effectively.	238	4.4706	.69140
The use of technology in Kelantan made it easier for me to navigate the area and find attractions.	238	4.4412	.72530
The technology used in Kelantan helped me learn more about the culture and history of the area.	238	4.4370	.73649
Overall, my satisfaction with my trip to Kelantan was positively influenced by the availability and use of technology.	238	4.5168	.70988

This table shows the Descriptive Analysis Statistic of Tourist Satisfaction. The item with the greatest mean was the use of technology during my visit to Kelantan enhanced my overall tourist experience. It had a 4.5252 mean, which is on the agreeable scale. The question with the second highest average, again at the level of agreement, was the availability of technology in Kelantan helped me plan my itinerary more effectively with a mean of 4.4706. The remaining questions for this independent variable, according to the data in the table, are at the neutral level. Next, it means the statement The use of technology in Kelantan made it easier for me to navigate the area and find attractions. Following that is mean for the technology used in Kelantan helped me learn more about the culture and history of the area is 4.4664. Finally, the mean for the tourist satisfaction with my trip to Kelantan was positively influenced by the availability and use of technology was 4.5168.

### **Reliability Analysis**



<b>Variables</b>	<b>Number of questions</b>	<b>Cronbach's alpha coefficient</b>
Types of Technology of Use	5	.786
Frequency of Technology Use	5	.857
Purpose of Technology Use	5	.879
Tourist satisfaction	5	.913

The table above is the findings of SPSS showing the importance of both independent and dependent variables in this analysis. All variables exceed or decrease. All variables were more than 0.700. The questionnaire has been safely approved and how many of our questions have been used to evaluate our title 'The Effectiveness of Technology Use Among Tourist Satisfaction in Kelantan'. The Cronbach Alpha results are 0.786 for first variables which are types of technology of use. This figure is questionable in terms of internal consistency ( $0.8 > \alpha \geq 0.7$ ) and has proven to be acceptable.

The following independent variable, frequency of technology use, was tested for validity and reliability using 5 questions. Cronbach's Alpha for this variable is 0.857. Internal consistency for this number is good ( $0.9 > 0.8$ ). The coefficients found for the variable for these questions are accurate. The third and last independent variable in the study is the reason for using technology. 5 elements make up this variable, which has a Cronbach's Alpha value of 0.879. Internal consistency for this number is also favourable ( $0.9 > 0.8$ ). The coefficients found for the variable for these questions are accurate.

There are five items that cast doubt on the validity of the dependent variable, tourist satisfaction. Cronbach's Alpha for this variable is 0.913, which is outstanding in terms of internal consistency (0.9). This suggests that the respondents' views on tourist satisfaction were consistent. Because all the studies in this research are highly steady ( $0.8 > 0.7$ ) to exceptional (0.9), they are all considered to be reliable. Finally, 0.954 is the overall reliability test score for all variables, which is regarded as being extremely good for reliability. Additionally, respondents may find it simpler to

comprehend the questions posed to some factors if they share the respondents' perspectives and grasp of the issues raised.

### Pearson Correlation Analysis

		<b>TT</b>	<b>FT</b>	<b>PT</b>	<b>TS</b>
<b>TT</b>	Pearson Correlation	1	.764	.735	.775
	Sig. (2-tailed)		<.001	<.001	<.001
	N	238	238	238	238
<b>FT</b>	Pearson Correlation	.764	1	.829	.773
	Sig. (2-tailed)	<.001		<.001	<.001
	N	238	238	238	238
<b>PT</b>	Pearson Correlation	.735	.829	1	.796
	Sig. (2-tailed)	<.001	<.001		<.001

	N	238	238	238	238
<b>TS</b>	Pearson Correlation	.775	.773	.796	1
	Sig. (2-tailed)	<.001	<.001	<.001	
	N	238	238	238	238

\*\* . Correlation is significant at the 0.01 level (2-tailed)

The association between the dependent variable, tourist satisfaction and the three independent variables, types of technology of use (TT), frequency of technology use (FT), and purpose of technology use (PT) are shown in Table 4.23. Types of technology of use, frequency of technology use and purpose of technology use have a positive correlation with tourist satisfaction. The connection between types of technology of use, frequency of technology use and purpose of technology use with tourist satisfaction is positive and has a strong correlation. As a result, this information demonstrates that all independent variables are linked to dependent variables.

## **DISCUSSION AND RECOMMENDATION**

For discussion and recommendation, to increase the credibility of the study, it is recommended to recruit more respondents beyond the typical limit of 238 participants. This will enhance the diversity and dependability of the research findings. Additionally, efforts should be made to ensure that the questionnaire's questions are easily understood to facilitate quicker and easier responses. One suggestion is to engage more individuals interested in tourism technology online to provide accurate and reliable answers, thus improving the accuracy of the research findings.

Based on the study's findings, several recommendations can be made to enhance the effectiveness of technology use in improving tourist satisfaction in Kelantan. Firstly, the Kelantan

State Tourism Board should invest in the development and improvement of mobile applications that provide comprehensive information and assistance to tourists. This can include features such as real-time updates on local events and attractions, interactive maps, and directions to popular destinations.

Secondly, tourism businesses in Kelantan should be encouraged to adopt and integrate technology into their operations. This can involve the implementation of online booking and payment systems, digital marketing strategies, and the utilization of smart technologies like automated check-in and check-out systems in hotels. Thirdly, providing adequate training and support to tourism industry professionals on the effective use of technology is crucial. Training programs can focus on utilizing mobile applications and social media platforms to engage with tourists, as well as collecting and analysing data to enhance business operations and customer experiences.

Fourthly, collaboration between the Kelantan State Tourism Board and local technology companies can foster the development of innovative and tailored solutions to meet the unique needs of tourists in Kelantan. This can include the creation of augmented reality applications that offer immersive experiences of Kelantan's culture and heritage. Lastly, continuous monitoring and evaluation of the effectiveness of technology use in enhancing tourist satisfaction in Kelantan is recommended. Regular surveys and data analysis can help identify areas for improvement and inform future investments and developments in this field.

In conclusion, implementing the above recommendations can contribute to improving the effectiveness of technology use in enhancing tourist satisfaction in Kelantan. Through investing in technology, providing training and support to tourism professionals, and collaborating with local technology companies, Kelantan can enhance its tourism offerings, attract more visitors, and generate greater economic benefits for the state.

## **CONCLUSION**

This study was conducted to learn more about the effectiveness of technology among tourist satisfaction. This study may be utilized as a reference by other academics who are doing research on technology use among tourist satisfaction. The results acquired in Chapter 4 using the Statistical Package for the Social Sciences (SPSS) were explored further, and inferences of the findings. As a result, it is intended that all the information gathered during using this study would assist associated parties in generating cash and profit.

## REFERENCES

- Abdullah, N. S. C., & Rahman, N. H. A. (2022). Tourist Satisfaction and Revisit Intention towards the Local Food Heritage in Kelantan. *Asian Journal of Arts, Culture and Tourism*, 4(3), 14-22.
- Akter, M., Sadekin, M. N., & Patwary, A. K. (2020). An Empirical Study on Students' Satisfaction from Mawlana Bhashani Science & Technology University, Bangladesh. *Review of Economics and Development Studies*, 6(2), 363-379.
- Alom, S., Patwary, A. K., & Khan, M. M. H. (2019). Factors affecting the turnover intention of Bangladeshi migrants in the United Arab Emirates: An empirical study on the hotel industry. *International Journal of Innovation, Creativity and Change*, 8(3), 344-360.
- Chen, Y., & Gursoy, D. (2008). The role of technology in enhancing destination competitiveness. *Journal of Travel Research*, 47(1), 57-66.
- Fengmin, Z., Baijun, W., Jiangtao, B., Li, L., & Patwary, A. K. (2022). Investigating revisit intention of medical tourists in China through nutritional knowledge, perceived medical quality, and trust in the physician: A recommendation on health tourism policy measures. *Frontiers in Public Health*, 10, 893497.
- Fuchs, M. (2016). Tourists' use of technology: A review of the literature. *Journal of travel research*, 55(1), 2-22.
- Hazbar, A. M. H., Alem Mohammed, A., & Karim, A. K. A. (2019). An Empirical Study of Factors Influencing hotel customers' online booking Intention. *مجلة العلوم التربوية و الدراسات الإنسانية*, (5), 1-17.
- Huang, C. D., Goo, J., Nam, K., & Yoo, C. W. (2017). Smart tourism technologies in travel planning: The role of exploration and exploitation. *Information & Management*, 54(6), 757-770.
- Kim, H., & Lee, H. (2018). The effect of technology on perceived risk and satisfaction in the tourism industry. *Journal of Travel Research*, 0047287517738672.
- Li, L., Ragavan, N. A., Patwary, A. K., & Baijun, W. (2022). Measuring patients' satisfaction toward health tourism in Malaysia through hospital environment, nutritional advice, and perceived value: A study on Chinese exchange students. *Frontiers in public health*, 10, 893439.
- Li, L., Wu, B., & Patwary, A. K. (2022). How marine tourism promote financial development in sustainable economy: new evidences from South Asia and implications to future tourism students. *Environmental Science and Pollution Research*, 29, 1155-1172.
- Li, L., Wu, B., & Patwary, A. K. (2022). The psychosocial factors affecting chinese Outbound Exchange and mobility students' academic performance during COVID-19. *Frontiers in psychology*, 13, 872516.
- Li, X., & Petrick, J. F. (2018). The impact of technology on tourist satisfaction: An empirical study. *Journal of Travel Research*, 57(8), 989-1005.
- Li, X., & Wang, D. (2016). The effect of mobile technology on tourist satisfaction and destination loyalty. *Journal of Destination Marketing & Management*, 5, 20-29.
- Li, X., Wang, D., & Liang, T. (2013). The impact of information and communication technology on customer satisfaction and loyalty in the hotel industry. *Journal of Hospitality Marketing & Management*, 22(3), 259-282.
- Li, X., Wang, D., & Liang, T. (2015). Social media in tourism and hospitality: A literature review. *Journal of travel & tourism marketing*, 32(1), 1-30.

- Mohd, R. et al. (2020). Exploring the Role of Technology in Enhancing Tourist Experience: A Case Study of Kelantan. *Journal of Tourism and Hospitality Management*.
- Nasir, M. N. M., Rasdi, A. L. M., Khan, N. F. A. H., Rahim, M. A., & Kamaruddin, M. (2023, July). Linking the Relationships Between Perceived Value and Destination Loyalty in Langkawi Island: Mediating Role of Place Attachment and Tourist Satisfaction. In *Industry Forward and Technology Transformation in Business and Entrepreneurship: Proceedings of the International Conference on Entrepreneurship, Business and Technology (InCEBT) 2022* (p. 279). Springer Nature.
- Pai, C. K., Liu, Y., Kang, S., & Dai, A. (2020). The role of perceived smart tourism technology experience for tourist satisfaction, happiness and revisit intention. *Sustainability*, 12(16), 6592.
- Patwary, A. K., Roy, B., Hoque, R., & Khandakar, M. S. A. (2019). Process of developing a community based tourism and identifying its economic and social impacts: An Empirical study on Cox's Bazar, Bangladesh. *Pakistan Journal of Humanities and Social Sciences*, 7(1), 1-13.
- Sumethokula, P., Patwary, A. K., Srinuanpanc, B., Srinuanpand, C., Suwandee, P., Thammathikul, A., & Phanong, W. (2020). The potential of new tour repackaging for creative tourism among entrepreneurs in Nakhon Si Thammarat. *International Journal of Innovation, Creativity and Change*, 13(10), 1752-1771.
- Wang, D., & Li, X. (2017). The impact of technology on tourist satisfaction and loyalty: An extension of the technology acceptance model. *Journal of Travel Research*, 56(2), 193-208.
- Wang, D., & Wang, D. (2018). Tourism information search behavior: A literature review. *Journal of Travel Research*, 0047287517744449.
- Wang, D., & Wang, D. (2019). The impact of mobile technology on tourist satisfaction and loyalty. *Journal of Travel Research*, 0047287519883344.
- Wu, B., Liu, S., Wang, J., Tahir, S., & Patwary, A. K. (2021). Assessing the mechanism of energy efficiency and energy poverty alleviation based on environmental regulation policy measures. *Environmental Science and Pollution Research*, 28, 40858-40870.
- Wu, B., Zhai, B., Mu, H., Peng, X., Wang, C., & Patwary, A. K. (2021). Evaluating an economic application of renewable generated hydrogen: A way forward for green economic performance and policy measures. *Environmental Science and Pollution Research*, 1-15.
- Xiang, Z., Du, Q., & Fan, W. (2016). The impact of social media on hotel booking intentions: Evidence from China. *Journal of Business Research*, 69(12), 5497-5504.

# **FACTORS INFLUENCING VISITOR'S AWARENESS LEVEL AND VISITOR'S SATISFACTION LEVEL TOWARDS SAFETY IN TOK BALI, KELANTAN**

**NOR AFIFAH BINTI AHMAD, NOR AIN NATASYA BINTI AWIE, NOR AMALIN NAJWA BINTI MOHD ALARAKAN, NOR FARAH HAZNEY BINTI NOR AZMI**

*FACULTY OF HOSPITALITY, TOURISM, AND WELLNESS, UNIVERSITI MALAYSIA  
KELANTAN*

## **ABSTRACT**

This study was proposed to examine the Satisfaction level towards safety in Tok Bali, Kelantan. The independent variable of this study consists of the local tourist, knowledge, Infrastructure, and local culture. Next, this has four objectives to examine to identify local tourist's factors that be the reasons of satisfaction level towards safety in Tok Bali, to identify knowledge factors that influence satisfaction level towards safety in Tok Bali, to identify infrastructure factors that influence satisfaction towards safety in Tok Bali, and to examine local culture factors satisfaction safety in Tok Bali. This study is to attract more tourists who come to Tok Bali, for a holiday with family and friends and improve to safety in Tok Bali.

**Keywords:** local tourist, knowledge, infrastructure, and local culture.

## **INTRODUCTION**

### **1.1 BACKGROUND OF THE STUDY**

The study's historical context is Malaysia's Kelantan state. As the nation's capital and the royal family's residence, Kota Bharu serves as both. Its Arabic honorific is Darul Naim ("The Blissful Abode"). In the northeastern portion of the peninsula, in Kelantan, there are beautiful paddy fields, attractive fishing communities, and beaches bordered by coconut trees. Due to Kelantan's relative seclusion and predominantly agricultural lifestyle, its culture differs fro

Malay culture in the rest of the peninsula. Tok Bali is a location that tourists should not skip to visit seeing while in Kelantan. In recent years, it has served as an alternative departure point for tourists to the Perhentian Islands. The villagers' main source of income in Tok Bali is fishing. Meanwhile, here there is also the historical name of the destination. It comes from an experience that had happened in the past time. The truth is, Tok Bali actually comes from fishermen from Bali, Indonesia. Although some of opinions about Tok Bali is started from other moment but it is also started with the moment, the place was called and known as Tok Bali. So, here we were decided to make the research about visitors' awareness level and visitors' satisfaction level towards safety in Tok Bali.

## **1.2 RESEARCH QUESTION**

1. What is the relationship local tourists with satisfaction level towards safety in Tok Bali?
2. What is the relationship knowledge with satisfaction level towards safety in Tok Bali?
3. What is the relationship infrastructure with satisfaction level towards safety in Tok Bali?
4. What is the relationship local culture with satisfaction level towards safety in Tok Bali?

## **1.3 SIGNIFICANCE OF THE STUDY**

Our research's primary focus is on generation Y. Generation Y is group born between 1980 and 1995. Generation Y is also the millennial or millennial generation that uses technology a lot. (Kouperschmidt,2000 in Putra,2016). This is because generation Y is more committed in deciding and openness. Generation Y will also have a higher level of awareness and high concern for safety if they visit a place. For example, it will learn from mistakes with awareness in themselves. Therefore, the focus on generation Y is very beneficial because they know about tourism. This will give a high chance in attracting more tourists from outside to come Tok Bali, because they upload in social media like, Instagram, Tik Tok, Facebook and so on. This will be able to advance the tourism sector in our country.



## **1.4 DEFINITION OF TERMS**

### **SAFETY**

Providing the high quality in tourism depends on safety and security. The ability to offer guests a safe and secure environment is more important to a tourism destination's success or failure than any other economic activity. This document is the end product of serious research by the WTO. It looks at both local and national planning considerations. Case studies for a various tourism industries are also provided, along with concepts for brochures.

### **AWARENESS**

Awareness is the state of being aware of something. It is more particularly the ability to personally know and sense, feel, or be aware of happenings. Another definition is that is a condition in which a person is aware of certain information when a knowledge is immediately available to bring to bear a wide variety of behavioural behaviours. The idea is frequently used as a synonym for consciousness and is also thought to be awareness itself.

### **LOCAL CULTURE**

Local culture is local culture refers to a personality that describes the culture practiced in a country. So here the local culture is too important when it will be the example for the others tourists. Connecting with the locals is at the centre of any vacation (Reisinger & Turner, 2003). Carmichael (2005) identifies social interaction between tourists and locals as both an essential and memorable part of the tourism experience (Morgan & Xu, 2009).

### **KNOWLEDGE**

Knowledge is refers to subjective part of a tourist own experience that involves in learning and education (Morgan & Xu, 2009). People can decide where to go and what to do when they get there based on how much they like to learn (Poria, Butler, & Airey, 2004). Hirschman and. Holbrook (1982) says that expending feelings can lead to interest, enjoyment, and feelings of happiness, and the stream of associations can lead to learning. (McKercher & du Cros, 2002) tell that travellers can learn a lot from their travel experiences. This comes learning in the form of new practical skills, knowledge, practical wisdom, and consciousness.

## **LITERATURE REVIEW**

### **Local Tourist**

Local tourists are individual who enjoy short journeys within their country, familiar with its history, traditions, and landmarks. They spend money on lodging, transportation, and food, contributing to the local economy. They seek authentic experiences, visit famous sites, explore the outdoors, and attend cultural events. They are environmentally conscious, opting for eco-friendly accommodations and activities, and often seek lesser-known destinations to support sustainable tourism practices.

### **Knowledge**

Knowledge is a subjective aspect of the tourist knowledge experience, which is involving learning and education. People can choose destinations and activities based on their interests. Consumption feelings can lead to enjoyment and pleasure, while associations can foster learning. Travel experiences designate towards new practical skills, knowledge, wisdom, and consciousness. Knowledge encompasses factual awareness, practical abilities, and familiarity with items or circumstances, with philosophical disagreements on justification and necessity.

### **Infrastructure**

Beach infrastructure comprises beaches access like parking, lifeguard stations, restrooms, changing facilities, promenades, recreational amenities, coastal protection measures, and environmental conservation efforts. It ensures safety, cleanliness, and accessibility while providing convenient pathways, lifeguard stations, and recreational facilities. Coastal protection measures protect the shoreline from erosion, while environmental conservation efforts maintain ecological balance and waste management.

## **Local Culture**

Local culture related to a country's collection of behaviors, beliefs, and practices, which include anything from how people eat and dress to how they work and communicate. Meeting locals is at the heart of each trip (Reisinger & Turner, 2003). According to Carmichael (2005), the social connection between tourists and locals is an important and memorable component of the tourism experience (Morgan & Xu, 2009).

## **Satisfaction Level Toward Safety in Tok Bali**

The concept of satisfaction is widely studied by existing literature (Nasir et al., 2021). Tok Bali's high safety satisfaction is due to various factors, including trained lifeguards, well-maintained facilities, clear signage, and safety precautions. Risks are reduced, and a safe environment is promoted through adequate lighting and designated swimming areas. Collaboration between regional government agencies and beach management groups enhances safety procedures, while regular drills and community participation further enhance preparedness. Tok Bali ensures a consistently safe and enjoyable experience for beachgoers through ongoing monitoring and improvements based on visitor feedback.

## **Factors Influencing Visitor's Awareness Level and Visitor's Satisfaction Level Towards Safety in Tok Bali.**

Research appropriate that visitor awareness and satisfaction with safety at tourism destinations are significantly influenced by factors such as pollution and pollution. Safety is the most important factor in the development of tourism, and Tok Bali is no exception. The absence of pollution, such as river and river pollution, ensures visitors' safety and prevents diseases while they are there or after returning home. Tok Bali's cleanliness and absence of pollution make it a top destination for visitors, as it prevents diseases and ensures their safety. As a result, visitors trust the quality of their stay and are satisfied with their safety in Tok Bali.

## Research Hypothesis

The proposed theory focuses on factors like local culture, knowledge, infrastructure, and customer behaviour affecting safety satisfaction in Tok Bali. From the study, the following hypothesis has been designated and tested.

H1 - There is a relationship between local culture with a level of satisfaction with safety in Tok Bali.

H2 - There is a relationship between knowledge considering safety satisfaction in Tok Bali.

H3 - There is a relationship between infrastructure with satisfaction intensity of safety in Tok Bali.

H4 - There is a relationship between customer behavior and with satisfaction Tok Bali`s degree of safety.

## Research Framework

A study framework investigates the relationship between tourist safety satisfaction in Tok Bali and visitor awareness, considering factors like local culture, knowledge, infrastructure, and local culture as independent variables.

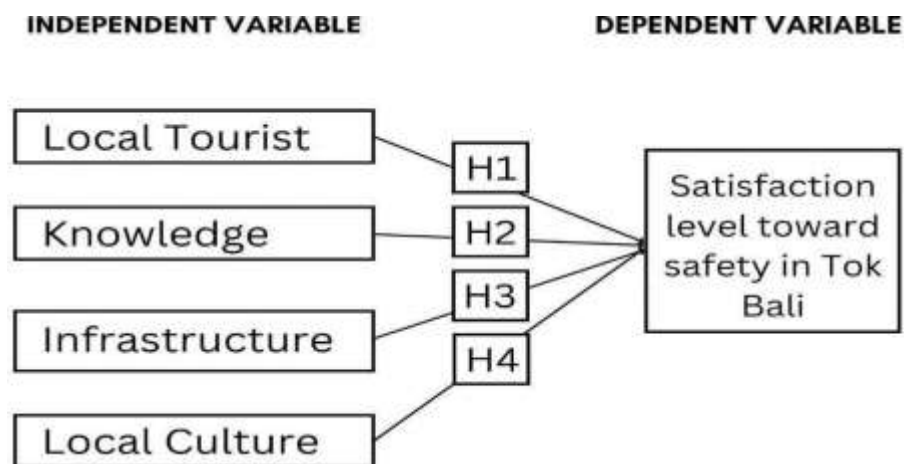

Figure 1: Proposed Conceptual Framework Adapted from Erore Sthapit & Dafnis

## **METHODOLOGY**

### **RESEARCH DESIGN**

Research design is describing about the meaning of a tips for answering the research question using empirical data. In creating a research design, it is related to the means that makes decisions about the all of the research objectives and approach. Besides, sampling of the methods or criteria for selecting subjects is also should be considered in describing the research design. It is because the sampling method is one of the ways that will help the readers.

### **POPULATION**

Visitors to Tok Bali, Kelantan, which are 50 respondents were chosen as respondents for this study. The data will be collected in and around Tok Bali, Kelantan. This study focuses on visitors who like to visit Tok Bali, Kelantan, to determine their level of awareness and satisfaction with safety in Tok Bali. This population was chosen because the researcher lives nearby, making it easier for the study to locate respondents, and consumption patterns have long been a source of concern for Tok Bali residents concerned about visitor awareness and satisfaction levels with safety.

### **SAMPLE SIZE**

A sample is a subset of a population from which data is collected. The sample size is always less than the total population size (Pritha Bandari (2020). The sample size justification for such studies should explain how the collected data is expected to provide valuable information given the researcher's inferential goals (Lakens, D. (2022). The sample size is a group of people chosen from the general population to be considered of the real population for the purpose of the study. Inappropriate, too large, or too small sample sizes continue to have an impact Equation I provide the sample's formula with a 95% confidence interval and a 5% level of significance.

## DATA COLLECTION

According to (Craig Stedman et al.,2022), data collecting is the progress of acquiring data for being considered in business decision-making, strategic planning, research, and other purposes. Quantitative data had gathered complete and draw the characteristics, behaviours of populations (Parohoo,2006). This research uses the method data from the survey questions. This survey's questions are simple for respondents to respond. The collection data to support findings and analysis.

### SAMPLING

Sampling involves choosing a representative sample of the population being studied Mcleods. (2019). Convenience sampling is non-probability sampling method used in this investigation. The convenience sampling is the most common form of no probabilistic sampling, misused according by (et Thomas W. Edgar al.,2017). Quantitative research that focus on quantifying the collection and analysis of data based on the study. This enables the researchers to archive the sample size they need in a relatively easy and inexpensive manner. Researchers have provided random questionnaires to study increasing visitor awareness level and visitor satisfaction level toward safety in Tok Bali.

### RESEARCH INSTRUMENT

Research tools used to gather, quantify, and assess data relevant to the research issue. A proper research questionnaire contains both closed and open questions. Respondents can expound on their responses when the questions are lengthy and open-ended. Questionnaires used for data collecting can generate both qualitative and quantitative information. Questionnaire surveys could or might not contain surveys, however the surveys should always be used in connection with questionnaires.

Strongly Disagree	1	2	3	4	5	6	7	Strongly Agree
-------------------	---	---	---	---	---	---	---	----------------

Table 1 Breakdown of Measure



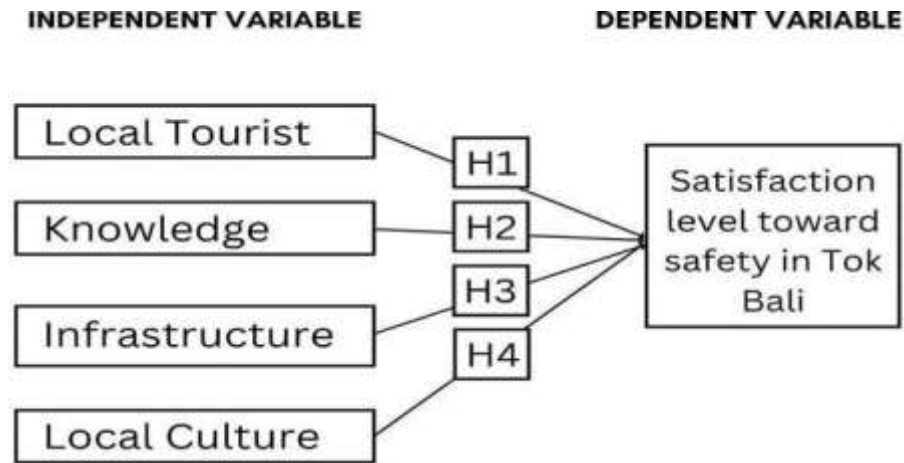

Figure 2: posed Conceptual Framework Adapted from Erore Sthapit & Dafnis

N. Coudounaris 2017

## DATA ANALYSIS

The progress of collecting, modelling, and evaluating information orderly to derive knowledge that can be applied to decision-making. There are numerous ways and procedures for manage analysis, depending on the field and the objectives. Diverse data analysis techniques are thus generally based on two main study subfields: quantitative methods and also qualitative approaches. To extract usable information from data and base judgements on that analysis is the purpose of data analysis. There are main and secondary primary data in research methodology. Primary data refers to data that researchers have gathered from original sources such surveys and interviews.

## FINDINGS

### DEMOGRAPHIC PROFILE

The online platform had assigned a total of 208 sets of questionnaires. The contextual profiles of the respondents existed in this segment. About 38 % of the respondent were male and another 62 % were female. The table showed most of the respondents in the race are Malay with 82.2% followed by Chinese with 10.6% and from Indian has 7.2%. The table also shows the respondents who responded to this survey are speciously aged between 18 -35 above years old with the frequency of 208 respondents. This is tracked by 22 - 25 years old with 128 respondents

(61.5%), follow by respondent age from 26 - 30 years' old which is with 15.9% and 22 respondents from 18 - 21 years old (10.6). Both of age between 31 - 35 years old with 18 respondents.

Additionally, table 4.5 indicated that most respondents have a degree (74%, n=154). This followed by 26 of the respondents (12.5%) from certificated, 12 of the respondents (5.8%) has a master. Also, 16 respondents (7.7%) from primary and secondary. Based on table also shows the respondent's status. The highest status of respondents is single status with 158 respondents (76%), then, follow by married tracks this with 49 respondents (23.6%), and the balance of 1 respondent (5) has a taken status. Lastly, the table indicated that most respondents is a student (68.8%, n=143). This followed by 28 of the respondents (13.5%) has an employee, 17 of the respondents (8.2%) are from business owner occupation, 16 of the respondents (17.7%) from a government officer, And the balance is from housewife which is 4 respondents with 1.9 percentages.

<b>RESPONDENT PROFILE</b>	<b>CLASIFICATION</b>	<b>FREQUENCY N = 208</b>	<b>PERCENTAGE (%)</b>
GENDER	Male	7	38%
	Female	9	62%
		1	
		2	
		9	
RACE	Chinese	2	10.6%
	Indi an Mal ay	2	7.2%
		1	82.2%
		5	
		1	
		7	
1			

AGE	18 – 21	2	10.6%
	22 - 25	2	61.5%
	26 - 30	1	15.9%
	31 - 35	2	8.7%
	35	8	3.4%
	Above	3	
		1	
EDUCATION AL LEVEL	Certific ate	2	12.5%
		6	74%
	Degree	1	5.8%
		5	7.7%
	Master	4	
		1	
	Primary/Seconda ry	2	
1			
	6		

MARITAL STATUS	Married	4	23.6%
	Single	9	76%
	Taken	1	5%
		5	
		8	
OCCUPATION	Business Owner	1	8.2%
	Employee	7	13.5%
	Government Officer	2	7.7%
		8	1.9%
	Housewife	1	
		6	68.8%
	Student	4	
		1	
		4	
		3	

### Reliability Test

The calculation's reliability indicates the instrument's stability and precision in calculating the definition, thus contributing to the measure's goodness

Variables	Bil of Item	Cronbach's Alpha coefficient	Strength of Association
Local Tourist	5	0.830	Excellent
Knowledge	3	0.836	Excellent
Infrastructure	3	0.864	Excellent
Local Culture	3	0.858	Excellent

Satisfaction Level Toward Safety	14	6.0865	Very good
----------------------------------	----	--------	-----------

Table 3 Result of Reliability Test

Cronbach's Alpha Coefficient values for the independent and dependent variables in this study are shown in Table 3, the conclusion presented is reliable and may be accepted in this study. all variables were mostly over 0.8. The questionnaire was approved, and five questions were used to assess local tourist in Tok Bali, Kelantan. The Cronbach Alpha result is 0.830 and has been proven to be excellent. The coefficient obtained for knowledge questions was also accurate.

Afterwards, Knowledge that influenced visitors' awareness level and satisfaction level toward safety in Tok Bali have a three questions were used and Cronbach's Alpha result is 0.836,

which indicated good. Hence, the coefficient obtained for these questions in the knowledge variable was reliable.

Then, three questions were used to calculate the infrastructure that influenced the visitor's awareness level and satisfaction level toward safety in Tok Bali, and the Cronbach Alpha outcome is also 0.864, which was also indicated as excellent. The coefficient obtained in the infrastructure variable for this variable was accurate.

Finally, three questions were to calculate the Local Culture intention variable Towards Safety in Tok Bali, and the Local Culture outcome was .858, which was indicated as excellent. The Satisfaction Level Towards Safety in Tok Bali for these questions in the Local culture was thus accurate.

### **Descriptive Analysis**

Descriptive statistic is being the short descriptive coefficient that summarizes a given data set, which can represent a population or a sample population

<b>Variable</b>	<b>N</b>	<b>Mean</b>	<b>Standard deviation</b>
Local Tourist	208	6.0483	1.13571
Knowledge	208	6.1875	1.17132
Infrastructure	208	6.0048	1.09676
Local Culture	208	6.0673	1.06108
Satisfaction Level Toward Safety	208	6.0865	.98893

Table 4 displays on the independent variable and dependent variable, the mean and standard deviation analysis. Local tourist, Knowledge, Infrastructure and local culture was independent variable while dependent variable was Satisfaction Level Toward Safety. The highest mean value was knowledge which is 6.1875, where respondents supported more on this variable. Meanwhile, the lowest mean value was infrastructure, which is only 6.0048 where in this study the respondents agreed lower for that variable

## Pearson Correlation

Spearman's correlation coefficient method was used to assess the contact between the independent and dependent variables. A numerical analysis of the heading and the strength of the direct connection between independent variables and dependent variables may be necessary to determine the correlation coefficient. The title and quality of the direct relationship between independent variables and dependent variables were examined digitally by Spearman.

**H1: There is a positive relationship between local tourist and satisfaction level toward safety in Tok Bali.**

		Local Tourist	Satisfaction Level Toward Safety in Tok Bali
Local Tourist	Pearson Correlation	1	.830**
	Sig. (2-tailed)		<.001
	N	208	208
Satisfaction Level Toward Safety in Tok Bali	Pearson Correlation	.830**	1
	Sig. (2-tailed)	<.001	
	N	208	208

Table provided that the results of the correlation between satisfaction level toward safety in Tok Bali and Local tourist are 0.830. The consequence proved that there is a relationship between the variables. The positive value of the correlation coefficient 0.830 indicated that their relationship is very highly positive.

**H2: There is a positive contact between knowledge and satisfaction level toward safety in Tok Bali**

		Knowledge	Satisfaction Level Toward Safety In Tok Bali
Knowledge	Pearson Correlation	1	.836**
	Sig. (2-tailed)		<.001
	N	208	208
Satisfaction Level Toward Safety In Tok Bali	Pearson Correlation	.836**	1
	Sig. (2-tailed)	<.001	
	N	208	208

Table provided that the results of the correlation between satisfaction level toward safety and knowledge are 0.836. The consequence proved that there is a contact between the variables. The positive value of the correlation coefficient 0.836 indicated that their relationship is very highly positive

**H3: There is a positive contact between infrastructure and satisfaction level toward safety in Tok Bali.**

		Infrastructur e	Satisfaction Level Toward Safety In Tok Bali
Infrastructure	Pearson Correlation	1	.864**
	Sig. (2-tailed)		<.001
	N	208	208



Satisfaction Level Toward Safety In Tok Bali	Pearson Correlation	.864**	1
	Sig. (2-tailed)	<.001	
	N	208	208

Based on table established that the relationship between satisfaction level toward safety and infrastructure was stated as 0.864. This result exposes the existence of the relationship between the variables. The positive value of the correlation coefficient 0.864 indicated that their relationship is very highly positive.

**Hypothesis 4: There is a positive relationship between local culture and satisfaction level toward safety in Tok Bali.**

		Local Culture	Satisfaction Level Toward Safety in Tok Bali
Local Culture	Pearson Correlation	1	.858**
	Sig. (2-tailed)		<.001
	N	208	208
Satisfaction Level Toward Safety in Tok Bali	Pearson Correlation	.858**	1
	Sig. (2-tailed)	<.001	
	N	208	208

Table shows the relationship between Satisfaction level toward safety and local culture at 0.585, which indirectly augment the relatively strong relationship between variables. It shows that a significant, strong, and very high positive correlation between Satisfaction level toward safety and local culture

**Summary result of Spearmen Correlation Coefficient.**

Hypothesis	Significant Value	Conclusion	Correlation Value	Conclusion
1	0.001	Accepted	0.830	Very high positive

2	0.001	Accepted	0.836	Very high positive
3	0.001	Accepted	0.864	Very high positive
4	0.001	Accepted	0.858	Very high positive

---

All the 4 variables have a strong relationship with satisfaction level toward safety in Tok bali.

Hence, all hypothesis is accepted. Table serves to summarize the findings of this study.

## **DISCUSSION AND RECCOMENDATION**

The study was direct to examine the contact between local tourist, knowledge, infrastructure and local culture and Satisfaction level toward safety.

The researcher acknowledge that there were several limitations to their study. The first limitation is focus on small sample size. This study's relatively limited sample confines to respondents who agree and disagree about satisfaction level towards safety in Tok Bali.

For the second limitation, the researcher only focus on Tok Bali respondents through questionnaire. We believed in Tok Bali level towards safety can attract more tourists to come for holiday with family and friends because the safety will improve. Throughout the study in Tok Bali, we lacked respondents because we could not meet more of respondents there. Due to the lack of respondents we could not produce accurate collect data.

Beside that, promoting domestic tourism and supporting the safe return of international tourism in Tok Bali, Kelantan. Special bundles and promotions are available. We may work with lodging providers, attractions, and local businesses to create appealing packages and promotions aimed exclusively toward domestic travellers

In addition, clear information is provided to travellers and businesses, reducing uncertainty. It is critical to maintain social media platforms up to date in order to keep travellers and companies informed and involved. Tok Bali may publish timely updates, news, and critical information via social media channels, ensuring travellers are informed of any changes or developments. It also enables proactive communication by swiftly responding to travellers' questions, concerns, and feedback, building a feeling of responsiveness and dependability

## CONCLUSION

The summary of relevant knowledge reveals that the overall purpose of this research has been met. Almost half of those who responded to the survey gave a positive response regarding the level of security in this area. They also want to visit in the future following the unforgettable experience they get especially from the local culture, knowledge, refreshment and meaning. They enjoy and enjoy being in the area because they are surrounded by beautiful sea views and can breathe fresh air.

## REFERENCES

1. management, e. (n.d.). *qualtrics.xm*. Retrieved from Sampling method: <https://www.qualtrics.com/au/experience-management/research/samplingmethods/>
2. methodology, b. r. (n.d.). *methodology*. Retrieved from Data Collection Method: <https://research-methodology.net/research-methods/datacollection>
3. Walton, J. K. (2012, January 27). Tourism | Definition, History, Types, Importance, & Industry. Retrieved from <https://www.britannica.com/topic/tourism>
4. Lakens, D. (2022). Sample size justification. *Collabra: Psychology*, 8(1), 33267
5. Kim, H., Koo, C., & Chung, N. (2021). The role of mobility apps in memorable tourism experiences of Korean tourists: Stress-coping theory perspective. *Journal of Hospitality and Tourism Management*, 49, 548-557.
6. Cohen, E. (1979). A phenomenology of tourist experiences. *Sociology*, 13(2), 179-201.
7. Gatrad, A. R., & Sheikh, A. (2005). Hajj: journey of a lifetime. *Bmj*, 330(7483), 133-137.
8. Hosany, S., Sthapit, E., & Björk, P. (2022). Memorable tourism experience: A review and research agenda. *Psychology & Marketing*.

9. LeBlanc, M. (2004). Tourist Characteristics and their interest in attending festivals and events:  
An Anglophone/Francophone case study of New Brunswick, Canada.

# THE EFFECT OF DESTINATION ATTRIBUTES ON TOURIST LOYALTY AFTERMATH OF THE CRISIS.

Nor Farah Isnairah Binti Shafae, Nor Rafizah Binti Abdul Majid, Nor Sitti Binti Wasimin,  
Noralia Binti Mohd Nor & Dr. Nor Syuhada Zulkefli \*

Corresponding author: [syuhada.z@umk.edu.my](mailto:syuhada.z@umk.edu.my)

*Faculty of Hospitality, Tourism, and Wellness, University Malaysia Kelantan*

---

## ABSTRACT

In the current global economic situation aftermath of crisis, tourist loyalty, as a critical component in assessing travel experiences, remains a focus of destination marketing organizations to succeed in an increasingly competitive tourism industry. This research aimed to determine the effect of destination attributes on tourist loyalty in Malaysia. This research used a quantitative approach. The collected data were obtained through a questionnaire distributed to 304 respondents. The research results showed that the destination attributes significantly influenced tourist loyalty. Results showed that the effect of destination attributes will be reduced during a crisis, allowing tourist destinations to attract tourists.

**Keywords: Crisis, Tourist Loyalty, Destination Attributes, Quantitative, Malaysia.**

---

## INTRODUCTION

The COVID-19 pandemic seriously impacted countries on the tourism landscape. However, destination loyalty becomes more fragile in times of crisis due to the travellers' aroused fears, massive competition, and the emergence of safer places as new touristic destination brands (Gössling et al., 2020). Yet unfavourable information about destinations in general and crisis.

Tourism is an important driving force for regional economic development because it contributes to the generation of jobs and the enrichment of many related industries (San Martin & Rodriguez del Bosque, 2018). According to Gitelson & Crompton (2020), the tourism sector is important in society to contribute to the local economy. The tourist sector can help communities get financial resources. Therefore, the community should strive to attract more repeat visitors as the global market becomes increasingly competitive. In an increasingly competitive international tourism market with new emerging destinations, mature destinations can gain a competitive advantage through repeat visits. Impacted destinations specifically influence the actual experience (Nam et al. 2020).

According to Matiza (2021) and Yeh (2021), one key pillar in post-crisis tourism recovery is a strategy to ensure that tourists' loyalty to visit the tourism destination. Given the contemporary global tourism environment, tourism marketing has become critical to re-igniting tourism demand. Bastiaansen et al. (2020) conclude that destination marketing in tourism aims to enhance the affective component of the destination image, which in turn affects the destination decision of tourists. The destination attributes are to describe the place that the tourist destination has a travel attribute while traveling and the image of the destination that will be going (Mazlina Mahdzar, 2018). As a result, the destination attributes will impact the tourist destination in that they have their own choice and will be satisfied with the sales behavior (Gani, 2018).

Destination attributes have been recognized as an important element of destination identity (Saraniemi and Komppula 2017) and they have been the subject of research in many studies to date (Djeri et al., 2018; Ragavan et al. 2014). The utmost goal of tourist destinations is to achieve tourist satisfaction (Zhan et al. 2018) and, in order to assess overall satisfaction, the importance of and satisfaction with each component of a destination should be evaluated (Gursoy, Chen and Chi 2014). However, destination loyalty becomes especially more fragile in times of crisis due to the travelers' aroused fears, massive competition, and the emergence of safer places as new touristic destination brands (Gössling et al., 2020; Stylidis et al., 2020).

According to Nam et al., 2020, there are several factors that generate loyalty to tourism destinations after the crisis. The study examined various aspects was basic comfort facilities, tourist attraction, economic factors, safety, and security. When getting information from tourists, tourists are more inclined to visit destinations that have infrastructure facilities and interesting activities even if safety and security are less encouraging. To that end, this study is focusing on the factors of destination attributes that influence tourist loyalty during and aftermath of the crises. Therefore, the crisis will be affected to the tourism industry in Malaysia.

## **SIGNIFICANCE OF THE STUDY.**

### **Awareness of destination attributes.**

The demand-side perspective on the phenomenon of tourism destination development has been the subject of many studies. The tourist area needs to be researched first before starting the study to make sure the area is good or not. Community awareness in the destination was either a lot or not. The



researcher needs to ensure that the design chosen for the study was suitable according to the desired purpose.

### **Increase domestic tourism.**

Domestic tourism destinations need to be added to attract tourists to travel within the state. The improvement of abandoned tourist areas by beautifying the area so that it was livelier and became an attraction for national tourists to come and travel to this area of the state. Each state needs to plan to think about how to improve tourism destinations in their respective states.

### **Covid-19 impact.**

This was a study of the crisis covid 19. The study was made to see the changes that happened after and before covid 19 whether it changed for the better or worse. The right destination will not be the cause of the economy or declining attributes if everyone is good at maintaining and cleaning the area. Accurate control needs to be done to prevent the spread of covid-19 from continuing to increase.

## **LITERATURE REVIEW.**

### **The Basic Comfort of Facilities.**

Destination facilities are very important for the tourism sector. It not only has interesting places to visit, but it also has needs and facilities that can meet all the needs and wishes of tourists (Dzia-Uddin & Zakaria, 2018). Among the examples of basic facilities that must be provided by the destination are accommodation, transportation, and interesting activities to ensure that tourists (visitors) enjoy their days in that place. Destinations equipped with facilities or infrastructure can satisfy tourists and attract tourists to visit the destination repeatedly.

### **Variety of Tourist Attractions.**

Tourist attraction was influenced by behaviour patterns and population, as well as the flexibility of activities and budget (Oram, 2022). Food, with its unique traditions and tastes, also attracts tourists, as they have their own expectations and tastes. Culinary activities are more popular than activities in tourist destinations. Attractions in the travel and tourism industry aim to capture customers' attention and encourage them to explore various attractions during their holidays. There are four types: purpose-built, natural, events, and heritage attractions. Attractions are crucial in attracting tourists from around the world, making them an essential part of the industry.

### **Economic Factors.**

The tourism sector is crucial for generating income and boosting the national economy (Yusof, 2017). Factors like topography, economic factors, and job opportunities are crucial for businesses. Focusing on these factors can improve the economy and create job opportunities, reducing unemployment rates in Malaysia. This not only provided better living conditions but also enhances skills and experience for employees. Economic factors influence the economy, including interest rates, tax rates, laws, policies, wages, and government activity. These factors were not directly related to the business but affected the future value of the investment.

### **Safety and Security.**

Battour et al. (2011) found that tourists' safety and cleanliness were crucial factors in decision-making. Strong security and crime-free destinations attract visitors, while clean, pollution-free destinations attract those who feel safe and comfortable. Tourists were more attracted to destinations with comfortable air and clean, safe environments. A tourism destination's success relies on providing a safe and secure environment for visitors. Safety involves natural disasters like hurricanes and earthquakes, while security involves anthropogenic factors like political instability and terrorist attacks. Factors like location, interdependencies, safety, awareness, image, brand, and cost or value contribute to a destination's competitiveness.

### **The Tourist Loyalty.**

The intention of the traveller to return to the same location is characterized by good word of mouth and a sense of pleasure for the pleasant experience they had. While being the best predictor of post-visit behaviour, destination loyalty was an important component of marketing strategy (Chen & Chen, 2010). A key component of loyalty is the desire to return to the destination, and various authors have investigated this topic in-depth to determine the factors that enable reaching high values in the chance of recurrence (Backman & Crompton, 1991; Cronin, Brady, & Hult, 2004).

### **Research Hypothesis.**

A hypothesis needs to be plausible, testable, and consider the most recent discoveries and methodologies. A forecast or an explanation of the relationship between two variables is also referred to as a hypothesis. It suggests that an independent variable and a dependent variable are related causally.

As a result, the research suggests:

- H1: There was a positive relationship between basic comfort of facilities and tourist loyalty.
- H2: There was a positive relationship between tourist attraction and tourist loyalty.
- H3: There was a positive relationship between economic factors and tourist loyalty.
- H4: There was a positive relationship between safety and security tourist loyalty.

### Research Framework.

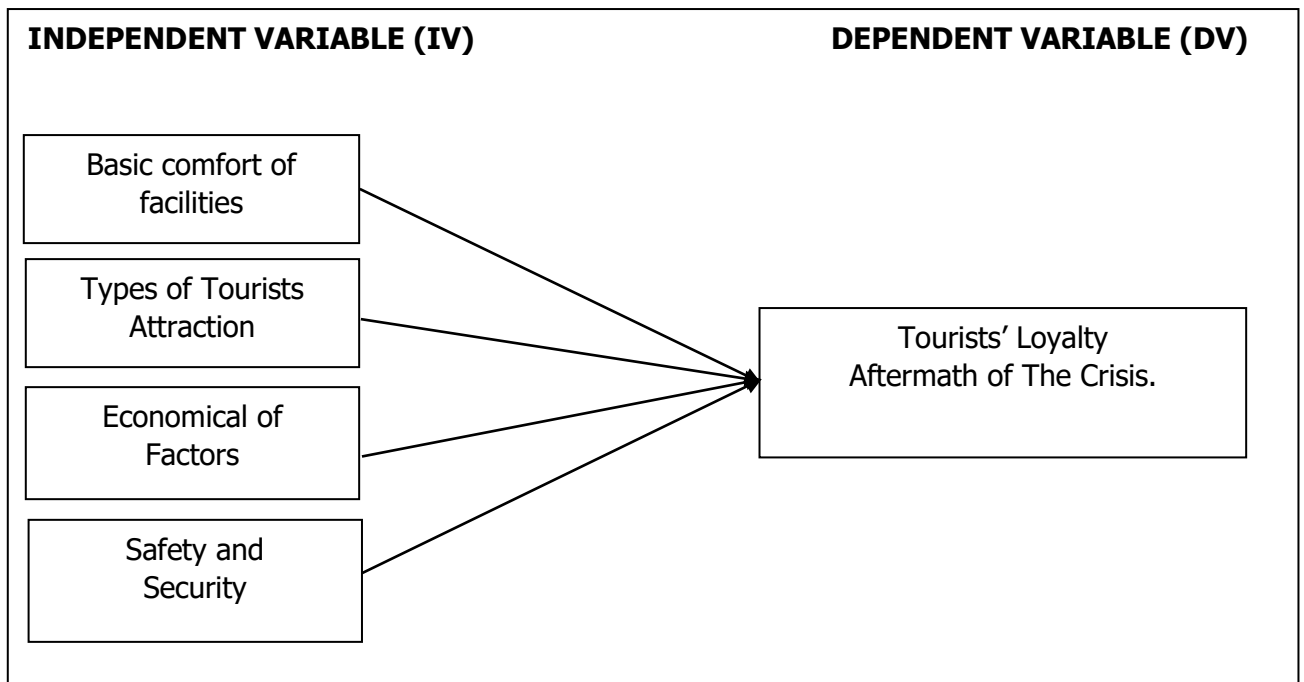

**Figure 1: The Conceptual Framework for The Relationship between Destination Attributes and Tourist Loyalty.**

### METHODOLOGY.

#### Research Design

In this study, quantitative research and experimental design were used as research design. Quantitative research includes the use of mathematical, statistical, and computational tools to obtain results. Therefore, it can be defined as a structured causal relationship between problems and factors. Large-scale research surveys help in generating statistics in quantitative research using methods through questionnaires or structured interviews (SIS International Market Research, 2018).

#### Data Collection

There were two types of data collecting used: primary and secondary. According to Robson (2007), a researcher should gather more information than is necessary and employ the least

complicated method possible to gather data and identify the answers to their study questions. The researcher has also chosen a questionnaire as a data collection tool to accomplish the goals of this study. To gather respondents, the researcher will be conducting a questionnaire through social media, such as Facebook tourism sites in Malaysia. This is because the data that received through this technique is easier to analyse and more accurate.

### **Sampling Method**

The convenience sampling technique, which uses non-probability sampling, is employed in this study. A set number of observations are selected from a larger population during the sampling process, which is a statistical research technique. This study needs a descriptive survey, this sampling strategy is helpful. In this study, the convenience sampling approach was applied to the distribution of the questionnaire to the intended respondents (Social Science Research Methods, 2018).

### **Data Analysis**

According to Shamo and Resnik (2003), there are a few analytical techniques that offer a means of deducing inferences from the data and identifying the sounds contained in the data. The Statistical Package for Social Science (SPSS) was a computer programme that the researchers used to analyse closed questions. The statistical descriptive, reliability test, and Spearman correlation analysis were used to examine the data.

## **RESULT ANALYSIS AND FINDINGS**

### **DEMOGRAPHIC CHARACTERISTICS OF RESPONDENTS.**

The platform, which is based on the internet, has given out a total of 304 sets of questionnaires. About 39.8 % of the respondents were male, and another 60.2 % were female.

The respondents of this survey are falsely aged between 18-25 years old, a percentage of 70.4% with frequency 214 respondents. The second-highest percentage is 25-30 years old, a percentage 20.7% with frequency 63 respondents and 30 years old and above a percentage 8.9% with frequency 27 respondents answered the questionnaire.

The Malay race had the greatest response rate (64.8%) out of the 197 respondents who responded to this survey. The response rate from respondents of different nationalities was 31.3%, or 95 people. The Chinese then indicate that 10.3 percent, or 3.3%, of the population, responded. the remaining 7% of respondents, or 2 respondents, who identified as Indian.

A degree is a high level of education in the context of education, hence 102 respondents, or 46.4%, pointed out they had a degree. Asasi, with 33.6 responders, has the second-highest response rate at 33.6%. Third, 51 responses, or 16.8%, were Others. The 3.3% of respondents with master's degrees, or a total of 10 respondents, had the lowest level of education.

Sabah had the most responses (27% or 82) in terms of location. The states of Perak and Kelantan, with 15.8% or 48 responses, are the second highest. The state of Johor comes in second with 7.2% or 22 responders. Third, Selangor represents 6.3% of responders, or 19. Next, the same number of responses from the states—3.9%, or 12 respondents—came from Negeri Sembilan and Pahang. 3.3%, or 10 respondents, are from the Federal Territory, while 3%, or 9 respondents, are from Penang State. The state of Melaka came in second with 2.6% or 8 responses. The state of Perlis, with only 1% or 3 replies, has the fewest responders overall.

Table 1: Demographic profile of respondents

<b>Respondent profile</b>	<b>Classification</b>	<b>Frequency N=304</b>	<b>Percentage (%)</b>
<b>Gender</b>	Male	121	39.8%
	Female	183	60.2 %
<b>Age</b>	18-25 years	214	70.4%
	25-30 years	63	20.7%
	30 years old and above	27	8.9%
<b>Race</b>	Malay	197	64.8%
	Chinese	10	3.3%
	Indian	2	7%
	Other	95	31.3%
<b>Education</b>	Asasi	102	33.6%
	Degree	141	46.4%
	Master	10	3.3%
	Other	51	16.8%

## 1. Descriptive Analysis

Descriptive statistical analysis was used to back up the acquired data. According to Eiselen, Uys, and Porgieter (2005), descriptive statistics explain the components' total value and break it down into descriptive messages. Some of the simple questions utilised by researchers include frequency distribution, rate distribution, and mean computation. In our study, the outcomes are presented as tabular data.

**Table 2: The result of descriptive analysis of variable**

<b>Variables</b>	<b>N</b>	<b>Mean</b>	<b>Standard Deviation</b>
Tourist Loyalty	304	3.27	0.849
Basic Comfort of Facilities	304	3.71	0.889
Tourist Attraction	304	3.84	0.909
Economical of Factor	304	3.79	0.915
Safety and Security	304	3.42	1.125

Table show the independent variable and dependent variable, the mean and standard deviation analysis. **Basic Comfort of Facilities, Tourist Attraction, Economical of Factor and Safety and Security** was independent variable while dependent variable was **Tourist Loyalty**. The highest mean value was **Tourist Attraction**, which is 3.84, where respondents agreed more on this variable. Meanwhile, the lowest mean value was **Safety and Security**, which is only 3.42 where in this study the respondents agreed lower for that variable.

## 2. Reliability Test

As a result, the data was reviewed to determine the degree of accuracy using Cronbach's Alpha analysis as a reference. For all variables, Cronbach's Alpha must be better than 0.7. Table below shows the result of the reliability analysis.

**Table 3: Result of Cronbach's Alpha**

<b>Variable</b>	<b>Number of items</b>	<b>Cronbach's Alpha coefficient</b>	<b>Strength of Association</b>
Basic Comfort of Facilities	6	0.918	Excellent
Tourist Attraction	6	0.918	Excellent
Economical of Factor	6	0.917	Excellent
Safety and Security	6	0.922	Excellent

The table shows items for each variable have consistently and same characteristic. The first and second variable, Basic Comfort of Facilities and Tourist Attraction have same Cronbach's alpha coefficient 0.918 with strength excellent characteristic. In overall, our value Cronbach's alpha for each variable has the excellent of characteristic. These variables are significant and shows excellent strength of items for each variables.

### 3. The result of relationship between destination attributes and tourist loyalty

To examine the relationship between the independent and dependent variables, the Spearman correlation coefficient approach is used. In this study, there were four variables of destination attributes that influences of tourist loyalty in the aftermath of the crisis. Those hypotheses were accepted, which are

H1: There is a positive relationship between basic comfort of facilities and tourist loyalty. aftermath of the crisis.

**Table : The relationship between .....**

<b>Correlations</b>				
			Basic Comfort of Facilities	Tourist Loyalty
Spearman's rho	Basic Comfort of Facilities	Correlation Coefficient	1.000	0.746 <sup>**</sup>
		Sig.(2-tailed)		0.000
	Tourist Loyalty	Correlation Coefficient	0.746 <sup>**</sup>	1.000
		Sig.(2-tailed)	0.000	
**Correlation is significant at the 0.01 level (2-tailed)				

Table 4.18 shows the outcome of Spearman Correlation, which was run to determine the relationship between basic comfort of facilities and tourist loyalty in the aftermath of the crisis. Significant value and the number of cases which was 304. The p-value was 0.000, which was less than the significant level of 0.01. The correlation coefficient of basic comfort of facilities is 0.746 suggested high positive correlation between tourist loyalty aftermath of the crisis. This result is

supported that the basic comfort of facilities has a positive effect on tourists' loyalty to the destination (Dziatul Nadiah Dzia-Uddin & Nur Syazleen Zakaria, 2018). With complete basic facilities, tourists will feel comfortable and comfortable visiting the destination again.

H2: There is a positive relationship between tourist attraction and tourist loyalty in the aftermath of the crisis.

**Table : The relationship between .....**

<b>Correlations</b>				
			<b>Tourist Attraction</b>	Tourist Loyalty
Spearman's rho	<b>Tourist Attraction</b>	Correlation Coefficient	1.000	0.734 <sup>**</sup>
		Sig.(2-tailed)		0.000
	Tourist Loyalty	Correlation Coefficient	0.734 <sup>**</sup>	1.000
		Sig.(2-tailed)	0.000	
**Correlation is significant at the 0.01 level (2-tailed)				

Table 4.19 shows the outcome of Spearman Correlation, which was run to determine the relationship between basic comfort of tourist attraction and tourist loyalty in the aftermath of the crisis. Significant value and the number of cases which was 304. The p-value was 0.000, which was less than the significant level of 0.01. The correlation coefficient of basic comfort of facilities is 0.734 suggested high positive correlation between tourist loyalty aftermath of the crisis. According to previous research shows that loyal customers are willing to pay 20 to 25 percent more for their product (Almeyda-Ibáñez, and George 2017). Besides, the visitors are willing to pay more for the service in the destination (Godovikh and Tasci 2020).

H3: There is a positive relationship between economic factors and tourist loyalty in the aftermath of the crisis.

**Table : The relationship between .....**

<b>Correlations</b>				
---------------------	--	--	--	--



			Economical of Factor	Tourist Loyalty
Spearman's rho	Economical of Factor	Correlation Coefficient	1.000	0.712 <sup>**</sup>
		Sig.(2-tailed)		0.000
	Tourit Loyalty	Correlation Coefficient	0.712 <sup>**</sup>	1.000
		Sig.(2-tailed)	0.000	
**Correlation is significant at the 0.01 level (2-tailed)				

Table 4.20 shows the outcome of Spearman Correlation, which was run to determine the relationship between basic comfort of economic factors and tourist loyalty in the aftermath of the crisis. Significant value and the number of cases which was 304. The p-value was 0.000, which was less than the significant level of 0.01. The correlation coefficient of economic factors is 0.712 suggested a high positive correlation between tourist loyalty aftermath of the crisis. With advertising on social media, tourists will be able to find out everything that is available and special in the destination, and they occur and contribute to event tourism and destination marketing Sarah Tanford (2017).

H4: There is negligible relationship between safety and security and tourist loyalty aftermath of the crisis.

**Table : The relationship between .....**

<b>Correlations</b>				
			Safety and Security.	Tourist Loyalty
Spearman's rho	Safety and Security.	Correlation Coefficient	1.000	0.181 <sup>**</sup>
		Sig.(2-tailed)		0.002
	Tourit Loyalty	Correlation Coefficient	0.181 <sup>**</sup>	1.000

		Sig.(2-tailed)	0.002	
**Correlation is significant at the 0.01 level (2-tailed)				

Table 4.21 shows the outcome of Spearman Correlation, which was run to determine the relationship between basic comfort of safety and security and tourist loyalty in the aftermath of the crisis. Significant value and the number of cases which was 304. The p-value was 0.002, which was less than the significant level of 0.01. The correlation coefficient of safety and security is 0.181 suggested negligible correlation between tourist loyalty aftermath of the crisis. Aftermath of the crisis, the security of a place is one of the most significant deterrents to traveling (Hadiwijoyoin Prabowo et al., 2016).

## DISCUSSION AND RECOMMENDATION

Based on the results of correlation analysis that was presented in this report, it shows a significant relationship that exists between both variables. As we know, the tourist loyalty is highly positively correlated with a basic comfort of facilities, and they moderate the relationship with 0.746 or 72%. Since the significant levels of both variables show 0.000 that highly significant. H1 has been proven and they were accepted, and the research objective has been supported. This result is supported from the previous study that found whether there is any correlation or the relationship between the dependent variables and independent variables.

It will discuss the limitation that was related to sample size. The study's extremely limited sample restricts how far the findings may be applied. Future related research will need to expand the sample size and completely evaluate this research model to overcome this constraint and produce more precise study results. Another limitation is that the researcher only uses social media platforms such as WhatsApp to interact with respondents in Malaysia. Due to slow response times throughout the online survey, the researcher was unable to gauge the respondents' understanding of the research. In order to address the third constraint, the researcher was probably forced to restrict the scope of the study analysis and the size of the research sample.

Based on the study, the recommendation that it will tell about safety and security is very low in influencing the rate of tourists' loyalty to the destination after the crisis. This is because places that are interesting and have a variety of activities become the focus of tourists to visit the destination. However, the basic comfort of facilities, tourist attraction, and economy factory available in the destination has become one of the factors that encourage the presence of tourists, because without

road facilities or transport and accommodation tourists will not know about the existence of the place. Every place or tourist destination must provide complete infrastructure facilities and activities that are attractive to tourists to maintain the loyalty of tourists to the destination.

In addition, the researcher needs to provide souvenirs for the respondents to attract their interest in answering the questionnaire. This is because, while the researcher was collecting data, the researcher experienced difficulties in finding respondents. By giving souvenirs or gifts to respondents, the researcher will easily get respondents to answer this google form. Next, use various types of social media to spread the google form. This is because the researcher only focused on one social media platform to distribute the google form ie WhatsApp. The researcher's ability to use social media has made it difficult for the researcher to get many respondents. Therefore, researchers should use platforms such as Instagram, Facebook, TikTok and many other social media to find respondent.

## **CONCLUSION**

The aim of the research is to ascertain how basic facility comfort, tourist attractions, economic factors, and safety and security between tourist loyalty. The results of the study showed how, in the aftermath of the crisis, destination attributes have an impact on tourist loyalty. The results of demographic effects of destination attributes on tourist loyalty aftermath of the crisis such as gender, age, race, education, location, travel, and frequency. The result shows that all the effects have a positive relationship with tourist loyalty.

## **REFERENCES.**

- Akter, M., Sadekin, M. N., & Patwary, A. K. (2020). An Empirical Study on Students' Satisfaction from Mawlana Bhashani Science & Technology University, Bangladesh. *Review of Economics and Development Studies*, 6(2), 363-379.
- Alom, S., Patwary, A. K., & Khan, M. M. H. (2019). Factors affecting the turnover intention of Bangladeshi migrants in the United Arab Emirates: An empirical study on the hotel industry. *International Journal of Innovation, Creativity and Change*, 8(3), 344-360.

- Atsiz, O., & Akova, O. (2021). Cultural destination attributes, overall tourist satisfaction and tourist loyalty: First Timers versus Repeaters. *Advances in Hospitality and Tourism Research (AHTR)*, 9(2), 269
- Fengmin, Z., Baijun, W., Jiangtao, B., Li, L., & Patwary, A. K. (2022). Investigating revisit intention of medical tourists in China through nutritional knowledge, perceived medical quality, and trust in the physiologist: A recommendation on health tourism policy measures. *Frontiers in Public Health*, 10, 893497.
- Guzel, B. (2017). <DESTINATION ATTRIBUTES IN THE EYE of THE LOCAL PEOPLE [#350608]-361100 (1).pdf>. *Economic and Administrative Sciences* Vol. 18 (1), 1,2,3
- Hazbar, A. M. H., Alem Mohammed, A., & Karim, A. K. A. (2019). An Empirical Study of Factors Influencing hotel customers' online booking Intention. *مجلة العلوم التربوية و الدراسات الإنسانية*, (5), 1-17.
- Kamdari, R. Y. (2017). Resourch Gate. Faktor Tarikan Pelancongan Pantai: Kajian Kes Di Pantai Irama, Bachok, Kelantan., 480-492.
- LAPAROJKIT, S., & SUTTIPUN, M. (2021). The influence of customer trust and loyalty on repurchase intention of domestic tourism: A case study in Thailand during COVID-19 crisis. *The Journal of Asian Finance, Economics and Business*, 8(5),: 961-963.
- Leković, K., Tomić, S., Marić, D., & Čurčić, N. V. (2020). Cognitive component of the image of arural tourism destination as a sustainable development potential. *Sustainability*, 12(22),: 9413.
- Li, L., Ragavan, N. A., Patwary, A. K., & Baijun, W. (2022). Measuring patients' satisfaction toward health tourism in Malaysia through hospital environment, nutritional advice, and perceived value: A study on Chinese exchange students. *Frontiers in public health*, 10, 893439.
- Li, L., Wu, B., & Patwary, A. K. (2022). How marine tourism promote financial development in sustainable economy: new evidences from South Asia and implications to future tourism students. *Environmental Science and Pollution Research*, 29, 1155-1172.
- Li, L., Wu, B., & Patwary, A. K. (2022). The psychosocial factors affecting chinese Outbound Exchange and mobility students' academic performance during COVID-19. *Frontiers in psychology*, 13, 872516.
- loyalty: First Timers versus Repeaters. *Advances in Hospitality and Tourism Research (AHTR)*, Vol. 9 (2), 1,2. <https://doi.org/10.30519/ahtr.894577>
- M.S., S. T. (2017). *Tourism Management. Festival attributes and perceptions: A meta-analysis of relationships with satisfaction and loyalty*, 209-220
- Mahdzar, M . , & Gani, A. A. (2018). <Effects\_of\_Destination\_Attributes\_on\_Tourists\_Behavioral\_Intentions\_to\_Kuala\_Selangor.pdf> *Sustainability*, 8 (16) (Tourism Way Forward), 369. <https://doi.org/10.6007/IJARBSS/v8 i16/5138>
- Mahdzar, M., & Gani, A. A. (2018). Effects of destination attributes on tourists' behavioural intentions to Kuala Selangor. *International Journal of Academic Research in Business and Social Sciences*, 8(16),:367-375.
- Mai, K. N., Nguyen, P. N. D., & Nguyen, P. T. M. (2019). International Tourists' Loyalty to Ho Chi Minh City Destination—A Mediation Analysis of Perceived Service Quality and Perceived Value. *Sustainability*, 11(19), 3,4. <https://doi.org/10.3390/su11195447>
- Mai, K. N., Nguyen, P. N. D., & Nguyen, P. T. M. (2019). International Tourists' Loyalty to Ho Chi

- Minh City Destination—A Mediation Analysis of Perceived Service Quality and Perceived Value. *Sustainability*, 11(19), 4,5,6. <https://doi.org/10.3390/su11195447>
- Nurov, Z. S., Khamroyeva, F. K., & Kadirova, D. R. (2021, March). Development of domestic tourism as a priority of the economy. In E-Conference Globe (pp. 271-275).
- Patwary, A. K., Roy, B., Hoque, R., & Khandakar, M. S. A. (2019). Process of developing a community based tourism and identifying its economic and social impacts: An Empirical study on Cox's Bazar, Bangladesh. *Pakistan Journal of Humanities and Social Sciences*, 7(1), 1-13.
- Peltomaki, S. M. (2015). <Crises in the tourism industry and their effects on different generations.pdf>. University of Applied Sciences, 11, 1,2.
- Rapti, E., & Gkouna, O. (2022). Crisis Management in Tourism: Visit Intention, Destination Image and social media in Times of COVID-19, the Greek Case. *Geoj. Tour. Geosites*, 41, :564-570.
- Shahida Kanwel, Z. L. (2019). Sustainable. The Influence of Destination Image on Tourist Loyalty and Intention to Visit: Testing a Multiple Mediation Approach, 11-22.
- Stylos, N., & Andronikidis, A. (2013). Exploring the cognitive image of a tourism destination. *Tourismos*, 8(3),:77-79.
- Suhartanto, D., & Triyuni, N. (2016). Tourist loyalty toward shopping destinations: the role of shopping satisfaction and destination image. *European Journal of Tourism Research*, 13, :84-102.
- Suhartanto, D., Brien, A., Primiana, I., Wibisono, N., & Triyuni, N. N. (2020). Tourist loyalty in creative tourism: the role of experience quality, value, satisfaction, and motivation. *Current Issues in Tourism*, 23(7),: 867-879.
- Sumethokula, P., Patwary, A. K., Srinuanpanc, B., Srinuanpand, C., Suwandee, P., Thammathikul, A., & Phanong, W. (2020). The potential of new tour repackaging for creative tourism among entrepreneurs in Nakhon Si Thammarat. *International Journal of Innovation, Creativity and Change*, 13(10), 1752-1771.
- Sun, S., Zhong, L., Law, R., Zhang, X., Yang, L., & Li, M. (2022). <sustainability-14-11009.pdf>. *Sustainability*, 14, 11009(A Proposed Disapproch for Tourist Destination Crisis Management), 1,2,3. <https://doi.org/10.3390/su141711009>
- Wang, H., Yang, Y., & He, W. (2022). Does Value Lead to Loyalty? Exploring the Important Role of the Tourist–Destination Relationship. *Behavioral Sciences*, 12(5):136.
- Wu, B., Liu, S., Wang, J., Tahir, S., & Patwary, A. K. (2021). Assessing the mechanism of energy efficiency and energy poverty alleviation based on environmental regulation policy measures. *Environmental Science and Pollution Research*, 28, 40858-40870.
- Wu, B., Zhai, B., Mu, H., Peng, X., Wang, C., & Patwary, A. K. (2021). Evaluating an economic application of renewable generated hydrogen: A way forward for green economic performance and policy measures. *Environmental Science and Pollution Research*, 1-15.

# EXPLORING INNOVATION IN THE HOMESTAY PROGRAM

NORATHIRAH BINTI MAT ISA, NORATIQAHA BINTI SUHAIMI, NORAZIRA BINTI ISMAIL,  
NORFILZA BINTI HARIS FADILLAH, \*DR NOR SUHADA BINTI ZULKEFLI

*Faculty of Hospitality, Tourism and Wellness, Universiti Malaysia Kelantan  
Corresponding email: syuhada.z@umk.edu.my*

---

## ABSTRACT

---

With the growth of the experience economy in recent years, travellers have continued to propose new demands. In terms of lodging, they are less content with standard tourist accommodations and instead place a higher value on authentic experiences and sentiments. Therefore, the only way a homestay can provide tourists with a novel experience and boost its competitiveness and tourist appeal is if it is heightened innovation and exploitation of cultural connotations. Innovation is an essential aspect of the tourism sector. However, a lack of awareness among homestay operators of the importance of innovation implementation leads to some homestay programs' incompetence. This study aims to explore the capability of innovation homestay programs. In total, eight homestay programs at East Coast Malaysia were selected based on several criteria. Face-to-face interviews were conducted with the homestay's coordinators, and the collected data were analysed using the thematic analysis technique. The practical implication is that industry players can utilise the empirical data as a benchmark to upgrade the other program homestay in Malaysia to be more competitive.

---

**Keywords: Keywords: Homestay programs, innovation, tourism, qualitative, East Coast of Malaysia.**

---

## INTRODUCTION

### Background of the Study

The need to innovate is a shift for a business to continue to thrive in a highly competitive global market (Divisekeran & Nguyen 2018). So is the tourism sector which has shown great development stimulate and also become an economic sector the most competitive (Backman Klaesson & Öner 2017). This includes rural tourism seen as having great potential to provide a destination that has its own uniqueness and originality of products covering the beauty of nature, the diversity of customs, and local culture (Mapjabil & Ismail 2015). The homestay program is one of the rural tourism that is so popular in Malaysia. It has been created in 1995 with the aim of offering an

interesting experience to tourists (Ramele & Yamazaki 2020) including accommodation, provision of food and drinks, package activities, and community product enterprises (Suffarruddin et al. 2020).

The Malaysian government has allocated a budget towards developing the tourism industry, specifically through the homestay program, to increase income levels and reduce poverty rates. The homestay program has the potential to promote rural tourism, which aligns with the Eleventh Malaysia Plan's efforts to transform the countryside and improve the well-being of the community. Unlike regular accommodations, the homestay programmes focus on providing tourists with an authentic experience by staying with host families and partaking in local activities. It will allow tourists to learn about the lifestyle and culture of the local community (MOTAC, 2017). This program helps boost the income of villagers and supports the development of tourism in rural areas.

### **Problem Statement**

The COVID-19 pandemic severely impacted the tourism and hospitality industries, causing a 56% drop in international tourist arrivals and a loss of USD 320 billion in tourism exports in the first five months of 2020. The subsequent economic fallout led to a loss of USD 4.5 – 4.7 trillion and 62 million jobs in the travel and tourism sector. New standard operating procedures were implemented to limit the spread of the virus, with homestay operators urged to innovate through technology and social media to promote their businesses sustainably.

Even so, there are several programs and homestays that still offer services that affect the interest of tourists (Hussin & Kunjuraman 2014). This is because there are some less experienced entrepreneurs and knowledgeable in managing businesses as well as less exposure to innovation tourism (Sakdiyakorn & Sivarak 2016). The situation has affected the number of tourist arrivals thus reducing the total income of entrepreneurs and further causing them to be unable to survive again (Kasim et al. 2016). Data from MOTAC (2020) also shows almost 60 percent of the homestay program experienced a rate of decline often for the number of tourist arrivals from 2011 to 2019.

Based on previous studies, the focus on product innovation in the tourism industry is limited (Alsos et al. 2014; Martinez-Roman et al. 2015; Sakdiyakorn & Sivarak 2016) because the researcher focuses more on innovation in the sector manufacturing (Al-Ansari et al. 2013; Besides, previous studies in the tourism industry have focused on the impact of innovation in homestay programs, which can increase the income of homestay entrepreneurs. (Keling and Entebang, 2017; Boachie-Mensah &

Acquah 2015; Kafetzopoulos & Psomas 2015). **Therefore**, this study aims to identify what innovations are undertaken by homestay entrepreneurs to maintain stability in their homestay program after the outbreak of covid-19.

### **Scope of Study**

The research focuses on identifying innovations in homestay programs to support the growth of the tourism industry. Due to the Covid-19 pandemic, many homestays face financial challenges. This research is focused on the important element in the tourism business. This study also emphasizes the importance of innovation for entrepreneurs in the tourism sector to survive and thrive.

### **SIGNIFICANCE OF THE STUDY**

This research will provide a new perspective on the tourism industry about the potential of homestay programs In Malaysia. Most of the studies have discussed the community's involvement in homestay programs. However, research on the role of innovation in homestay programs is still limited. (Keling and Entebang, 2015). Therefore, the innovation aspect of tourism products needs to be studied in more detail in order to develop the tourism industry. Most homestays in Malaysia have their own uniqueness such as the beauty of nature and culture. The result of this study will contribute to enhancing domestic tourism development in rural areas. The development of the homestay program in Malaysia can increase the tourism industry and give tourist awareness about the importance of preserving culture. Therefore, innovation in the homestay program is important to attract more tourists.

### **LITERATURE REVIEW**

#### **Homestay programs**

The concept of community-based tourism (Community-Based Tourism, CBT) was first introduced in the mid-1990s (Asker, Boronyak, Carrard & Paddon, 2010) through community involvement in providing tourism products for economic, social, and political empowerment (Hussin & Kunjuraman, 2014). According to Jamaludin, Othman, and Awang (2012), CBT is the community's responsibility and ability to make decisions.

In the context of Malaysia, a homestay can be defined as a form of lodging component of tourism that offers a village or kampong lifestyle experience for tourists or visitors (Kayat, 2011). It



refers to private accommodation that offers a fully furnished house that enables tourists to stay with a host family for a certain period (Oxford Dictionary, 2013). This homestay lifestyle involves cultural exchange, especially with foreigners as tourists from many countries around the world. Homestay is not solely a platform to generate money, but it is also a platform for villagers in rural areas to develop their entrepreneurial skills (Pusiran & Xiao, 2013). As one type of lodging that the tourists share with the homeowner with the intention to learn culture and lifestyles from the homeowner who is willing to transmit and share culture.

In late 2019, the COVID-19 pandemic impacted all nations, societies, and industries globally. The tourism and hospitality sector were among the worst hit when business activities came to a sudden halt, international borders closed, travel restricted and partial/full lockdowns were ordered (OECD, 2020). Thus, the travel and tourism sectors have suffered significant losses. Therefore, in order to revitalize the tourism sector and business activities after the covid-19 pandemic, reforms need to be made to attract the community to revitalize the economy in the tourism and business sectors including in the homestay program.

### **Concept of Innovation**

The concept of innovation explains that innovation focuses on aspects of renewal and improvement. Innovation capability is an internal capability (Martínez-Román et al., 2015) that refers to the potential and ability to produce innovative products or services (Laforet, 2011). This involves the use of knowledge and ideas to produce something new in order to benefit the organization and stakeholders (Lawson & Samson, 2001).

Continuous improvement (Olsson, Wadell, Odenrick & Bergendahl, 2010) is also important by adding value to existing efforts (Hogan, Soutar, McColl-Kennedy & Sweeney, 2011).

Innovation is an important approach in the growth strategy to enter new markets in addition to improving existing markets and subsequently being competitive (Boachie-Mensah & Acquah, 2015). This approach is also in line with the economic objective which is to create innovation and difference to achieve business growth (Sundbo, 2019) as well as survive in the market (Jiménez-Jiménez & Sanz-Valle, 2011). Innovation also includes existing ideas that are reapplied or deployed in different settings for different customer groups. (Enz & Harrison, 2008).

### **Product Innovation**

Product and service innovation is defined as something offered based on new ideas (Myers & Marquis, 1969) aimed at providing various options to customers. Innovation is also an initiative that parallels the development of current technology and global competition (Gunday et al., 2011). Kafetzopoulos and Psomas (2015) argued that product innovation is a continuous effort and has a function involving increasing different levels of efficiency inside and outside the organization.

. In the tourism industry, product, and service innovation focuses on renewal and improvements made to products and activities offered to tourists in a destination (Cosma et al. al., 2014; Nieves et al., 2014). The innovation carried out is important to increase tourist visits by offering more attractive packages (Keling & Entebang, 2017).

### **Marketing Innovation**

Marketing innovation is the adoption of a new marketing strategy that involves significant changes in product design or packaging, product placement, product promotion, or pricing. Marketing innovations aim to better address customer needs, open up new markets, or reposition a company's product on the market, with the goal of increasing sales. ( Oslo manual, Third Edition, Paris, 2005 ) The implementation of a marketing method not previously used by the firm distinguishes a marketing innovation from other changes in a firm's marketing instruments.

It must be part of a new marketing concept or strategy that is significantly different from the firm's current marketing methods. The new marketing method can be created by the innovating company or adopted by other companies or organizations. Both new and existing products can benefit from new marketing strategies.

### **Process Innovation**

Process innovation is a business strategy that comprises modifying, introducing, and optimizing manufacturing. A company's needs may be better served by new services, software, and equipment that are developed and introduced as part of the creative process. Besides, process innovation is the introduction of new or significantly improved production, supply chain, and administrative processes. (Piening & Oliver Salge, 2015). The new method *"offers much-needed flexibility for accessing the public markets and is likely to encourage additional initial public offerings"* (Diamond, 2017). Innovation provides an opportunity for organizations to launch techniques and technical solutions to help businesses by reducing manufacturing costs. Innovation in

organizations widely becomes the main driver of organizational competitiveness. Therefore, innovation allows an organization to improve its product or service.

### **Management Innovation**

The term "innovation management" is also a source of much debate. Some argue that the very definition of innovation implies that it cannot be managed, whereas others are firm believers in developing systems and processes to foster more innovation. (Jesse Nieminen, 2018). Innovation management, according to Gartner, an IT research and consulting firm, is a business discipline that aims to drive a sustainable innovation process or culture within an organization. These innovation management initiatives frequently employ a disruptive method of change to transform business.

### **Research Framework**

The research aims to determine the performance of innovation in homestay programs, focusing on generating additional income for operators and improving the experience through innovative solutions. The research aims to improve local homestay operators' experiences and practices, resulting in knowledge installation and increased earnings for operators. Innovation can help homestay entrepreneurs expand their businesses and attract tourists to Malaysia's tourism industry.

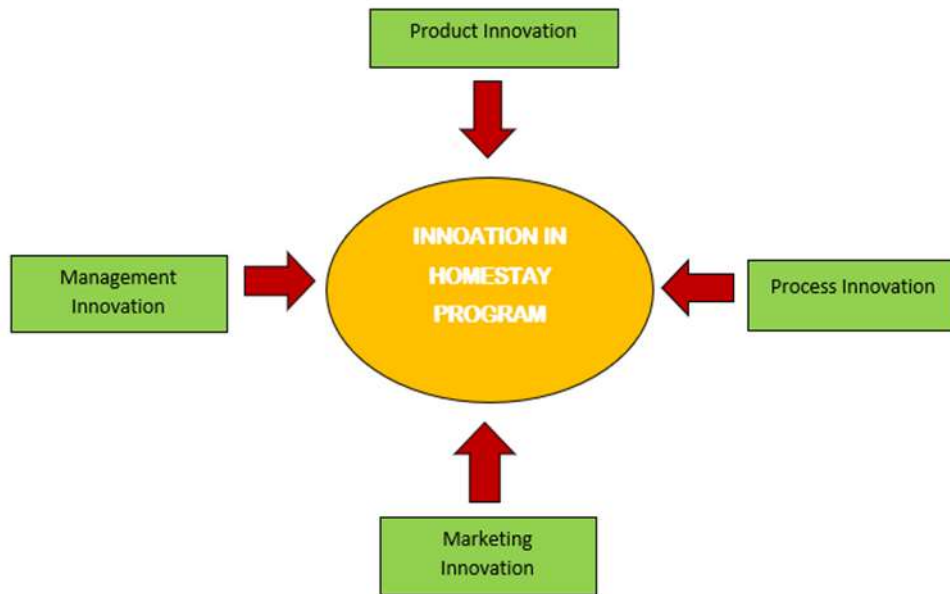

Figure 1: The Conceptual Framework

## METHODOLOGY

### Research Design

A qualitative approach was used through the method of semi-structured face-to-face interviews for case studies selected to get more information deep and detailed (Creswell 2014). Researchers will be in the respondent's situation in order to know the actual situation of the research issue covers the environment as well as sufficient evidence and is named as a case study (Yin 2011). There are three types of case studies: exploratory, descriptive, and explanatory.

The exploratory approach is preferred in this study, as it allows for a more detailed examination of innovation elements in homestay programs. This is in line with the recommendations of previous researchers, to answer the question of how and why innovation can happen (Sakdiyakorn & Sivarak 2016) especially in the homestay program (Hashim et al. 2015).

### Data Collection

Data collections involve collecting, measuring, and analyzing insights for research using proven techniques. Primary data is original data collected for the first time, while secondary data is gathered by another source. Data collection is crucial for conducting research, starting with deciding the data needed and selecting a sample. Techniques for data collection include documentation, archival records, interviews, direct observations, participant observation, and physical artifacts. The interview method is the most appropriate research approach for this study.

## **Sampling**

Qualitative data collection emphasizes quality over quantity, aiming to become saturated with information on a topic. It is guided by theoretical sampling, which helps determine when to stop sampling. Purposive sampling, a common method in qualitative analysis, is chosen for this study, as it provides rich information and is based on homestays registered with MOTAC in Kelantan. The study consists of three respondents, who have the best knowledge and experience regarding the research topic.

## **Data Analysis**

Within the qualitative method, there are a variety of data analysis techniques. The available tools include content analysis, constant comparison, successive approximation, thematic analysis, domain analysis, ideal type, event structure analysis, matrices, grounded theory, and other analytical methods (Silverman, 2006). However, choosing an appropriate technique depends on many factors, including the nature of the data and the type of research question to be addressed. This study uses thematic analysis to analyze textual data, coding, and creation of themes.

## **FINDINGS**

This paper analyzed the data obtained from the interview transcripts according to four categories of innovations. Category A involved product and service innovation; Category B which is marketing innovation; Category C was about management innovation and Category D involved process innovation as shown in Table 1.

Table 1: The result analysis of Innovation themes in Homestay Programmes.

<b>Themes</b>	<b>Sub-Themes</b>	<b>Respondent</b>	<b>Discussion</b>
<b>Product</b>	<b>Small Medium Enterprise (SME)</b>	<b>R1:</b> There are 10 types of foods product produce by the villagers themselves. Among them are Pekasam, salted eggs, honey baked, biscuits made form kelulut honey	This finding proves that SMEs have the potential to continue to thrive (Ahmad et al., 2017; Ismail, 2015) at the same time able to develop local community economy.
	<b>Types of Activities</b>	<b>R4:</b> Traditional game are enhanced by incorporating exploration activities. We provide 7 locations in each homestay. Tourists will play batu seremban, sepak takraw and congkak	This finding supports the study of Yusof et al., (2017) who found that the uniqueness of local food and culture can provide satisfaction for homestay program tourists.
<b>Process</b>	<b>Registration</b>	<b>R6:</b> “Tourists who come will go to the counter provided. So, all check-ins and check-outs happen here”.	This finding is in line with Aldebert et al. (2017) that the software used for registration can reduce costs and improve quality business.
	<b>Food Production</b>	<b>R1:</b> “What is popular now is eating in the	Sakdiyakorn & Sivarak (2016) proved that process

		village and in the river. In the village, we bring food there especially during the fruit season.”	innovation is very important to ensure products and services.
<b>Marketing</b>	<b>Traditional Media</b>	<b>R5:</b> “I also do promotions in my own store. Whoever comes here, I will give them a card and try to get them to visit the chalet so they can see the condition of the room for themselves.”	This result found innovation is entrepreneurs' effort in enhancing the advertising of their homestays and in line with previous findings involving homestays in Thailand (Yiamjanya, 2016)
	<b>Print Media</b>	<b>R3:</b> “Flyers are used to convey information to tourists and get an overview of our homestay.”	
<b>Management</b>	<b>Infrastructure</b>	<b>R2:</b> Before, we didn't have an office and it was quite difficult because all the work was done at the coordinator's house. now everything is managed in the office	This finding is an initiative to improve service quality (Cosma et al., 2014; Ronningen, 2016) in order to give comfort for tourists

**Product and services innovation**

This section describes product and service innovations in detail with respect to program-specific homestay changes and enhancements. According to the respondents' explanations, the goods and services offered can be divided into 3 categories such as small and medium enterprises (SMEs), types of activities, and accommodation. There are some homestays that create new packages by taking tourists to visit interesting places around the area. For example, R1 explained, *"We provide activities such as river cruises where tourists can go around, want to fish, visit the surroundings of Kuala Langat District up to Jugra. There is also an international paragliding place here"*. This effort is parallel to R3 and R5 which take tourists by bus to some interesting tourist destinations. Suffarruddin et al. (2022) and Hussin and Kunjuraman (2014) emphasize that such activities are usually able to offer natural enjoyment to tourists and are abundant in rural areas that are rich in natural resource

### **Process innovation**

Based on respondents' descriptions, process innovation is often linked to products and services offered. Among them are reforms in terms of providing registration counters and improving methods of preparing food and transportation for tourists. Online booking was another much sought-after feature identified by the visitors which could have made their booking experience easier. Booking.com allows the homestay owner to interact directly with prospective guests and makes it easier to communicate with the guests prior-arrival and see guest reviews after staying in the homestay. For example, one of the respondents R3 and R4 said that *"We have simplified administrative affairs by providing a specific space for homestay managers..."*. This innovation is in line with Aldebert et al. (2011) and Yiamjanya (2016) that the software and system used can reduce costs and improve business quality. However, this innovation is only found in a small number of homestay programs according to their respective ideas and abilities.

### **Marketing Innovation**

For promoting and differentiating the program, drawing in more visitors, and improving the overall guest experience, marketing innovation is used in the context of homestay programmes. Marketing innovation uses experience-based advertising and continuous improvement and guest feedback to create a marketing campaign. In this study, Most of the respondents who responded also said that the website needs to be better kept up to date to date and maintained. But some of the people who were listed on the website had already left. This finding is in line with previous findings involving homestays in Thailand (Yiamjanya, 2016).



## **Management innovation**

The management innovations emphasize to reform and improvement of all matters relating to the administration of the homestay program. Refers to the description of the respondent, the innovation of which can be classified into three categories, namely administrative structure systematic, improvement of the information management system, and construction administrative infrastructure. The study discovered that competent people are a vital asset in a company to start a better management journey in terms of the systematic administrative structure. This result is consistent with other research that discovered this initiative is crucial for enhancing human resource management (Sakdiyakorn & Sivarak, 2016).

## **DISCUSSION AND RECOMMENDATION**

The results of this study ought to have a substantial effect and help other homestay programs evolve in important ways. Through this initiative, the community may be exposed to innovation and development that can boost the local economy. The emphasis on innovation that has been made in the homestay program can then lead to the emergence of additional rural entrepreneurs. To accomplish this innovation, it is advised to each participant in the homestay program to be more sensitive to the surroundings that can influence invention. As a result, organizers, businesspeople, and communities are urged to emphasize the value of innovation, which calls for planning and a wide range of imaginative ideas.

## **CONCLUSION**

This study investigated the identification of innovation elements in homestay programs. It identified several innovations that were made to the homestays involved, such as reforms and improvements, which have been well received by tourists and helped smooth the relationship between homestay operators and tourists. The findings of this study should have a large impact and contribute significantly to the efforts of other homestay programs to innovate. The findings of this study should also have a large impact and contribute significantly to the efforts of other homestay programs to innovate. Coordinators, businessmen, and communities are urged to put more emphasis on the importance of innovation, which requires preparation and a variety of creative ideas.

## REFERENCES

- Akter, M., Sadekin, M. N., & Patwary, A. K. (2020). An Empirical Study on Students' Satisfaction from Mawlana Bhashani Science & Technology University, Bangladesh. *Review of Economics and Development Studies*, 6(2), 363-379.
- Aldebert, B., Dang, R. J., & Longhi, C. (2011). Innovation in the tourism industry: The case of Tourism. *Tourism Management*, 32(5), 1204-1213.
- Alom, S., Patwary, A. K., & Khan, M. M. H. (2019). Factors affecting the turnover intention of Bangladeshi migrants in the United Arab Emirates: An empirical study on the hotel industry. *International Journal of Innovation, Creativity and Change*, 8(3), 344-360.
- Alsos, G. A., Carter, S., & Ljunggren, E. (2014). Kinship and business: how entrepreneurial households facilitate business growth. *Entrepreneurship & Regional Development*, 26(1-2), 97-122.
- Asker, S., Boronyak, L., Carrard, N., & Paddon, M. (2010). *Effective Community Based Tourism: A Best Practice Manual*. Australia: Sustainable Tourism Cooperative Research Centre.
- Aziz, N. I. A., Hassan, F., & Jaafar, M. (2014). Exploring tourist experiences in Kampung Beng Homestay programme. *Asia-Pacific Journal of Innovation in Hospitality and Tourism (APJIHT)*, 3(1), 1-20.
- Backman, M., Klaesson, J., & Öner, Ö. (2017). Innovation in the hospitality industry: Firm or location? *Tourism Economics*, 23(8), 1591-1614.
- Bagus, S. I., Imade, S. U., Nyoman, S. I. A., & Putu, W. S. N. (2019). Community based tourism as sustainable tourism support. *Russian Journal of Agricultural and Socio-Economic Sciences*, 94(10), 70-78.
- Bhuiyan, M. A. H. (2019). Homestay for Community Based Tourism Development at Kampung Jelawang in Kelantan, Malaysia. *Soc. Sci. J*, 3, 73-81.
- Boachie-Mensah, F. & Aquah, I.S.K. (2015). The effect of innovation types on the performance of small and medium-sized enterprises in the Sekondi-Takoradi Metropolis. *Archives of Business Research*, 3(3), 77-98.
- Cosma, S., Paun, D., Bota, M., & Fleseriu, C. (2014). Innovation—a useful tool in rural tourism in Romania. *Procedia-Social and Behavioral Sciences*, 148, 507- 515. <https://doi.org/10.1016/j.sbspro.2014.07.073>
- Divisekera, S., & Nguyen, V. K. (2018). Drivers of innovation in tourism: An econometric study. *Tourism Economics*, 24(8), 998-1014.
- Fengmin, Z., Baijun, W., Jiangtao, B., Li, L., & Patwary, A. K. (2022). Investigating revisit intention of medical tourists in China through nutritional knowledge, perceived medical quality, and trust in the physiologist: A recommendation on health tourism policy measures. *Frontiers in Public Health*, 10, 893497.
- Gallagher, K. (2021, May 14). *What is community-based tourism? definition and popular destinations*. Treehugger. Retrieved December 14, 2022, from <https://www.treehugger.com/what-is-community-based-tourism-5181555>.
- Gunday, G., Ulusoy, G., Kilic, K., & Alpkan, L. (2011). Effects of innovation types on firm performance. *International Journal of Production Economics*, 133(2), 662-676. <https://doi.org/10.1016/j.ijpe.2011.05.014>
- Hashim, A. M., Jamalludin, N., Nor, M. N. M., Nazrin, N., Merican, F. M. I. & Ahmad, S. S. (2015). Langkawi Homestay: Exploring an innovation aspect in homestay industry. *Journal of Tourism, Hospitality and Sports*, 8, 14-19.
- Hazbar, A. M. H., Alem Mohammed, A., & Karim, A. K. A. (2019). An Empirical Study of Factors Influencing hotel customers' online booking Intention. *مجلة العلوم التربوية و الدراسات الإنسانية*, (5), 1-17.

- Hussin, R. & Kunjuraman, V. (2014). Pelancongan mapan berasaskan komuniti (CBT) melalui program homestay di Sabah, Malaysia. *GEOGRAFIA – Malaysian Journal of Society and Space*, 10(3), 160-174
- Kafetzopoulos, D., & Psomas, E. (2015). The impact of innovation capability on the performance of manufacturing companies: The Greek case. *Journal of Manufacturing Technology Management*, 26(1), 104-130.
- Kahn, K. B. (2018). Understanding innovation. *Business Horizons*, 61(3), 453-460.
- Kamila, D. (2016, July 11). *Homestay Malaysia Yang Unik, Lain Dari Yang Lain!* SirapLimau.com., from <https://siraplimau.com/homestay-malaysia-senarai-unik/>
- Kasim, M.M., Kayat, K. & Ramli, R. (2016). Sustainability criteria for the Malaysia Homestay Program. *International Review of Management and Marketing*, 6 (S7), 250-255.
- Kayat, K. (2011). *Homestay Program as a Tourism Product in Malaysia*. Sintok: UUM Press.
- Keling, W., & Entebang, H. (2017). Dayak homestay entrepreneurs innovation characteristics. *Ottoman: Journal of Tourism and Management Research*, 2(2), 101-112.
- Li, L., Ragavan, N. A., Patwary, A. K., & Baijun, W. (2022). Measuring patients' satisfaction toward health tourism in Malaysia through hospital environment, nutritional advice, and perceived value: A study on Chinese exchange students. *Frontiers in public health*, 10, 893439.
- Li, L., Wu, B., & Patwary, A. K. (2022). How marine tourism promote financial development in sustainable economy: new evidences from South Asia and implications to future tourism students. *Environmental Science and Pollution Research*, 29, 1155-1172.
- Li, L., Wu, B., & Patwary, A. K. (2022). The psychosocial factors affecting chinese Outbound Exchange and mobility students' academic performance during COVID-19. *Frontiers in psychology*, 13, 872516.
- Mapjabil, J., Ismail, S. C., Ab Rahman, B., Masron, T., Ismail, R., & Zainol, R. M. (2017). Homestays-community programme or alternative accommodation? A re-evaluation of concept and execution. *Geografia-Malaysian Journal of Society and Space*, 11(12), 1-8.
- Martínez-Román, J. A., Tamayo, J. A., Gamero, J., & Romero, J. E. (2015). Innovativeness and business performances in tourism SMEs. *Annals of Tourism Research*, 54, 118-135. <https://doi.org/10.1016/j.annals.2015.07.004>
- Myers, S. & Marquis, D. (1969). *Successful Industrial Innovation: A Study of Factors Underlying Innovation in Selected Firms*. Washington: National Science Foundation.
- Nair, V., & Hamzah, A. (2015). Successful community-based tourism approaches for rural destinations. *Worldwide Hospitality and Tourism Themes*, 7(5), 429-439. <https://doi.org/10.1108/WHATT-06-2015-0023>
- Nieves, J., Quintana, A., & Osorio, J. (2014). Knowledge-based resources and innovation in the hotel industry. *International Journal of Hospitality Management*, 38, 65-73. <https://doi.org/10.1016/j.ijhm.2014.01.001>
- Patwary, A. K., Roy, B., Hoque, R., & Khandakar, M. S. A. (2019). Process of developing a community based tourism and identifying its economic and social impacts: An Empirical study on Cox's Bazar, Bangladesh. *Pakistan Journal of Humanities and Social Sciences*, 7(1), 1-13.
- Piening, E. P., & Salge, T. O. (2015). Understanding the antecedents, contingencies, and performance implications of process innovation: A dynamic capabilities perspective. *Journal of Product Innovation Management*, 32(1), 80-97.
- Ramele, R., Juchi, Y., Ibrahim, M. N., Isnin, Z., & Safiee, L. S. (2017). The Evolution of Homestay Tourism in Malaysia. *Pertanika Journal of Social Science and Humanities*, 25, 301-306
- Resilience and Sustainability Strategies of Malaysian Homestay Program from* <http://journalarticle.ukm.my/19828/1/53265-184772-1-PB.pdf>
- Robinson, P., & Wiltshier, P. (2011). Community tourism. *Research themes for tourism*, 87-99.
- Ronningen, M. (2010). Innovation in the Norwegian Rural tourism industry: Results from a Norwegian survey. *The Open Social Science Journal*, 3, 15-29.

- Sakdiyakorn, M. & Sivarak, O. (2016). Innovation management in cultural heritage tourism: experience from the Amphawa waterfront community, Thailand. *Asia Pacific Journal of Tourism Research*, 21(2), 212-238
- Silverman, D. (2006). *Interpreting Qualitative Data: Methods for Analyzing Talk, Text and Interaction*. London: SAGE Publications
- Suflarruddin, S. H., Jaafar, M., & Rahman, S. (2021). Keupayaan Pelaksanaan Inovasi Produk dalam Program Homestay di Semenanjung Malaysia. *Jurnal Pengurusan*, 61, 109-120.
- Sumethokula, P., Patwary, A. K., Srinuanpanc, B., Srinuanpand, C., Suwandee, P., Thammathikulf, A., & Phanong, W. (2020). The potential of new tour repackaging for creative tourism among entrepreneurs in Nakhon Si Thammarat. *International Journal of Innovation, Creativity and Change*, 13(10), 1752-1771.
- Vajirakachorn, T., & Nepal, S. K. (2014). Local perspectives of community-based tourism: case study from Thailand's Amphawa Floating Market. *International Journal of Tourism Anthropology*, 3(4), 342-356.
- Wu, B., Liu, S., Wang, J., Tahir, S., & Patwary, A. K. (2021). Assessing the mechanism of energy efficiency and energy poverty alleviation based on environmental regulation policy measures. *Environmental Science and Pollution Research*, 28, 40858-40870.
- Wu, B., Zhai, B., Mu, H., Peng, X., Wang, C., & Patwary, A. K. (2021). Evaluating an economic application of renewable generated hydrogen: A way forward for green economic performance and policy measures. *Environmental Science and Pollution Research*, 1-15.
- Yiamjanya, S. (2016). Endogenous and Exogenous Factors for e-Marketing Technology and Innovation in Homestay Establishments: A Case Study of Samut Songkhram Province, Thailand. *Journal of Economics, Business and Management*, 4(1), 40-46.
- Yin, R. K. (2014). *Case Study Research. Design and Methods*, 5th ed. California: SAGE Publications

# EXPLORING THE POTENTIAL OF STAYCATION MAKING TO TRAVEL DURING AND AFTERMATH OF THE COVID-19

Norsyamieza Zulaika Binti Mohd Zaikimi, Norsyifa Ayuni Binti Kamaruzaman, Norzianah Binti Mohd Jefri \*Nor Syuhada Binti Zukefli

*Faculty of Hospitality, Tourism and Wellness, Universiti Malaysia Kelantan*

*Corresponding email: [syuhada.z@umk.edu.my](mailto:syuhada.z@umk.edu.my)*

---

## **ABSTRACT**

Globally, tourists have become more anxious to travel overseas due to increased uncertainties posed by disastrous global-scale incidents. The uncertainty crisis outbreak has significantly impacted on triggering important changes in tourism mobility and tourism. As a result, people have significantly changed their long-term traveling into near-term travel decisions. Therefore, this research aims to explore the new concept of staycation motivators by Malaysian vacationers on tourism mobility. The research employs an exploratory method with initially in-depth interviews by using a semi-structured set of questions. Data will be collected Globally; tourists have become more anxious to travel overseas due to increased uncertainties posed by disastrous global-scale incidents. The uncertainties crisis outbreak has significantly impacted on triggering important changes in tourism mobility and tourism. As a result, people have significantly changed their long-term traveling into near-term travel decisions. Therefore, this research aims to explore the new concept of staycation motivators by Malaysian vacationers on tourism mobility. The research employs an exploratory method with initially in-depth interviews by using a semi-structured set of questions. Data will be collected until it reaches saturation points. Thematic analysis will be conducted using Atlas.ti. There are seven vacationers involved as interviewees. There are four main elements in staycation concepts, which are 1) time period; 2) types of activities; 3) distance; and 4) place. The main limitation of this study is that the sample was small, but nevertheless, some interesting results were obtained.

**Keywords:** Crisis, Staycation, Experience, Qualitative

---

## **INTRODUCTION**

Since the Covid19 outbreak in late 2019, global disruptions in global flows and mobility have led to economic loss to the tourism industry, affecting human freedom and well-being. Tourists face high risks due to health hazards and government limitations. The shutdown of numerous communities and the implementation of major restrictions on border crossings has virtually eliminated the tourism economy in communities throughout the world (Goodwin, 2020). Places, which only a few months ago were suffering from extreme problems of over-visitation (Milano et al., 2019) are presently eerily quiet (Kimmelman, 2020). This is because the tourism industry has been severely damaged due to travel being regarded as a high-risk activity. Worse still, due to the uncertainty and misleading information about epidemics in social media, tourist perceptions, and behavior changes in traveling have led to significant reductions in travel demand (Romagosa, 2020).

According to Romagosa (2020), the Covid-19 outbreak has already had a very significant impact on tourism, triggering important changes in mobility, social behavior, consumption patterns, and leisure. This is based on the proposition that the increase in social and environmental concerns

(Lew 2020) will encourage post-crisis tourists to choose destinations closer to where they live and move to travel within their area, which is called a staycation. Staycation is a new tourism trend, especially for city dwellers, because of changing lifestyles and work-life balance preferences. Staycation has become a complex cultural phenomenon and is essentially a holiday spent close to home but creating a traditional holiday environment. Being a tourist is the result of an informed decision, based essentially on the way individuals determine what they perceive as being unknown to them and how they decide to discover that context (Diaz-Soria, 2017).

Currently, some people are spending their holidays locally (Jeuring and Haartsen, 2017) and favor a staycation, where the number of staycation offers is increasing in popularity during COVID-19. Millennials are significant consumers of staycation packages, which involve staying home and participating in leisure activities within day-trip distance of their residence without overnight accommodation. This type of domestic tourism is increasingly popular due to their interest in new activities and travel. Millennials' staycation experiences during COVID-19 may differ from conventional travel experiences, as staycations involve staying at home or near home while creating the ambiance of a standard vacation (Besson, 2017).

## **Problem Statement**

Domestic tourism has been understudied in literature, but its economic importance has been underestimated (Stylidis, Belhassen, & Shani, 2017). During Covid19, people are increasingly spending their holidays locally (Jeuring and Haartsen, 2017) and favouring staycations. This trend has become popular due to mobility constraints and border lockdowns. The staycation concept has gained attention due to the ongoing pandemic (Wong, Lin and Kou, 2021), but limited studies have considered it as a study object and potential empirical source of data.

During the Covid19 pandemic, the literature on staycation concepts has been limited (Knezevic Cvelbar & Ogorevc, 2020), raising questions about tourists' experiences, well-being, and psychological outcomes. A staycation can promote recuperation and recovery from daily exhaustion, replenishing resources, and potentially prevent severe health problems like depression, stress, trauma, and fear. However, there are limitations to staycation impact, as it has less pronounced effects on wellbeing than vacations spent outside one's usual living environment. Despite these limitations, the concept of staycation has the potential to offer recovery experiences and prevent severe health problems during this challenging time (de Bloom, Nawijn, Geurts, Kinnunen, & Korpela, 2017, p. 574).

Millennials are a significant consumer group for staycation packages (Barclays, 2019), seeking quality of life and meaningful experiences (Sethi et al., 2018). They are technologically savvy, trend-conscious, and open to trying new things. Staycations are locals who transform into domestic tourists due to their familiar surroundings but experience unique emotions, resulting in an extraordinary feeling of wonderment in their regular surroundings. Existing studies on staycations often overlook the younger consumer segment. James and colleagues (2017) study identifies four types of staycations: socialites, adventurous eaters, and culture enthusiasts. Therefore, this research aims to explore the concepts of staycation among Malaysian Millennials and drivers that push tourists to travel in the short-term period, staycation.

## **SIGNIFICANCE OF THE STUDY**

The goal of this research is to investigate the need for a millennial staycation in the tourist business, with an emphasis on aspects such as the distance that can influence millennials' staycation,

as well as social experiences on millennials' staycation that can enhance their motivation when working. The study's focus is on millennials' opinions of staycations. For millennials, quality of life and enjoyable experiences are more important than for older generations (such as baby boomers), who prioritize their careers more. Millennials may find staycations appealing as a new norm because they are open to new experiences and trend conscious (Dabija et al., 2018; Ketter, 2020; Siegel and Wang, 2019). According to Bowen and McCain (2015) and Williams and Page (2011), millennials are also sensitive to current events and potential future developments. Millennials' behaviors are primarily influenced by actual events in their lives.

## **LITERATURE REVIEW**

### **The Crisis Of Covid-19**

The tourism industry has been significantly impacted by the Covid-19 pandemic due to reduced tourist flow, travel plans, unemployment, and business investment. Health outbreaks such as foot-and-mouth disease, the SARS epidemic, and the Avian Influenza pandemic have also caused a decline in demand in multiple tourism sectors (Borzyszkowski, 2013; Herbane, 2013; Calgaro, Lloyd, & Dominey-Howes, 2014). The COVID-19 pandemic has had a more devastating impact on international travel and tourism, with international arrivals plunging by 97% in April 2020 to levels not seen since the early 1990s, resulting in a more than tenfold loss of international tourism revenue (Romagosa, 2020).

Staycations have grown rapidly during the COVID-19 pandemic and have become part of the emerging customer behavior inspired by the epidemic. Several countries have started the staycation initiative to encourage visits to local destinations, such as Ireland, Iceland, Italy, Poland, Slovenia, Lithuania, South Korea, and Thailand. The tourist industry has been one of the most impacted by the Covid-19 pandemic, with an estimated RM3.37 billion between January and February 2020. Decision-making is a complex and dynamic process that is influenced by variables from both socio-psychological and non-psychological perspectives. Research is needed to understand and describe the dynamic nature of the decision itself, as it is expected to be influenced in different ways by different situations like COVID-19 and different generations.

### **The Concept Of Staycations**

A staycation, sometimes known as a holiday or a mix of the words "stay" and "vacation," is a period when a person or family stays at home and engages in leisure activities that are easily accessible by day trip and do not necessitate overnight housing. (Sanchez-Rebull et al., 2022). By taking a holiday at home rather than abroad, the phrase has gradually evolved in British English to indicate domestic tourism. Staycation activities include using a home pool, visiting neighbourhood parks and museums, and attending fairs and theme parks. Some staycationers choose to follow a set of rules to replicate the experience of a traditional vacation. Setting a start and end date, making ahead arrangements, and avoiding routine are all examples of these rules (Wong, Lin & Kou, 2021).

The Covid-19 crisis has led to the development of proximity tourism, which is a form of domestic tourism with shorter length and proximity. A staycation is a vacation spent at or near one's home, creating a traditional holiday environment while enjoying everything that home and one's home ambiance have to offer (Rosu, 2020). According to Germann Molz (2009), staycations were represented through stillness and as 'undesirable' in the media, "a form of consumer mobility or as a failure of mobility" (p.282). In this manner, it was demonstrated how representations of mobility are constructed. Furthermore, staycation has been one of few concrete and feasible adaptations of tourism and hospitality activities factoring in the restrictions of mobility and access due to Covid-19, as against the immature recovery schemes such as the "tourism bubble," which has been nothing but disenchanting (The Strait Times, 2021).

## Millennials Group

Millennials, also known as Generation Y or Gen Y, are the generation in the West that comes after Generation X and before Generation Z (Saghiani, 2010). Researchers and the general public use the early 1980s as the starting birth years and the mid-1990s to early 2000s as the ending birth years when referring to the generation, which is typically defined as people born between 1981 and 1996. The millennial generation is a significant new market segment in the tourism industry. They are technologically savvy, open to trying new things, and have a lot of money to spend (Siegel and Wang, 2019). They prioritize the quality of life and meaningful life experiences and are one of the main consumers for staycation package items. Staycations are locals who transform into domestic tourists while on vacation because they are familiar with the surroundings but experience an extraordinary feeling of wonderment.

## RESEARCH FRAMEWORK

A theoretical framework is a network of linkages between variables that are logical, explicable, and elaborated with respect to the issue. The association between staycations and millennials from the workplace is important to comprehend for this study. The study aims to identify the factors that cause millennials to take a staycation from the workplace, whether short or long distance affects travel for vacation, and whether the experience while on vacation can improve performance or motivation when working, as shown in Figure 2.1 below.

**Figure 2.1:** The conceptual framework of the staycation concept among millennials group during and aftermath of the crisis.

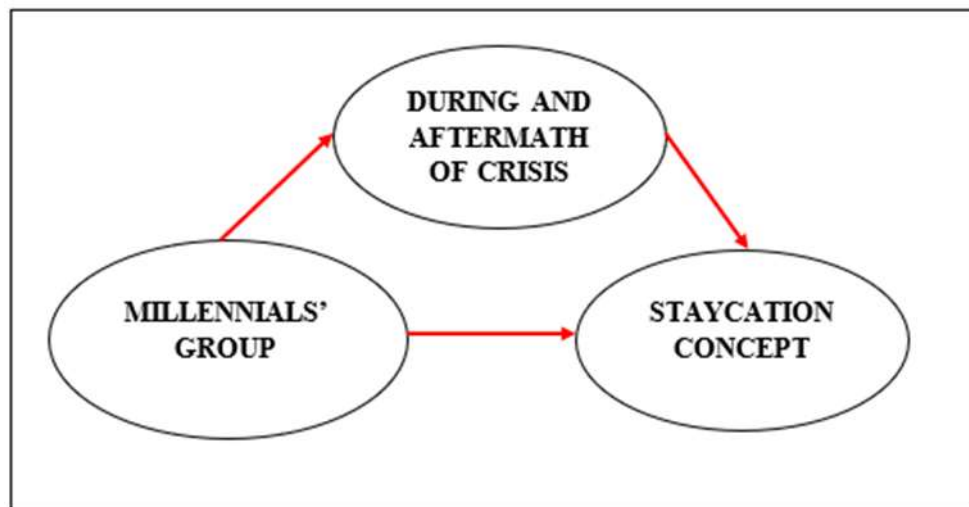



## METHODOLOGY

### Research Design

The research design involves choosing between quantitative and qualitative analysis methods. A qualitative approach summarizes phenomena based on numbers, while a quantitative approach is used to explore behavior, perspective, feelings, and experiences in real-life events. Researchers have chosen a case study as a qualitative research approach to investigate real-life events. A case study is an empirical inquiry that investigates a contemporary phenomenon within its natural context. There are three types of case studies: exploratory, descriptive, and explanatory.

The exploratory approach is preferred in this study, as it focuses on the potential of staycations among Millennials as a preferred travel choice during and after the COVID-19 pandemic. The case study's focus on examining the potential of staycations among Millennials as a preferred travel choice is relevant to this study.

### Data Collection

Data collections are the process of collecting, measuring, and analyzing research insights using proven techniques. They can be divided into primary and secondary data, with primary data being the original data collected for research purposes, and secondary data being data gathered by another source. Data collection is a critical stage in conducting research, starting with deciding the type of data needed and selecting a sample from a specific population. For case study approaches, various techniques are used, including documentation, archival records, interviews, direct observations, participant observation, and physical artifacts. Data collection aims to achieve research objectives and answer questions, with the interview method being the most appropriate research approach for this study.

Research questions	Research approach	Respondents
1. What are the concepts of staycation used among Millennials?	Semi-structured interview	Millennial's people
2. What are the drivers that push Millennials to make staycation?		
3. Can staycation be one travel choice made during and in the aftermath of the Covid19?		

Table 3.1: Questionnaire exploring the potential of staycation as one preferred destination to travel during and aftermath of the covid-19.

### Sampling

Purposive sampling, a common method in qualitative analysis, is chosen for this study, as it aims to select informants with the best knowledge and experience regarding the research topic. The sample size for this study is based on millennials in Malaysia, with a focus on age (born between 1981-1994) and professional type (lecturers). The sample size is among millennial groups in Kelantan.

## DATA ANALYSIS

Within the qualitative method, there are a variety of data analysis techniques from which to choose (Creswell, 2011; Patton, 2015). The available tools include content analysis, constant comparison, successive approximation, thematic analysis, domain analysis, ideal type, event structure analysis, matrices, grounded theory, and other analytical methods (Silverman, 2006). However, choosing an appropriate technique depends on many factors, including the nature of the data and the type of research questions to be addressed.

Normally researcher frequently uses content analysis and thematic analysis. The content analysis uses a descriptive approach in both coding of the data and its interpretation of quantitative counts of the codes (Hsieh & Shannon, 2005). Conversely, the thematic analysis provides a purely qualitative, detailed, and nuanced account of the data (Braun & Clarke, 2006). However, both of these analyses are sets of techniques and systematic processes to analyze textual data, coding, and creation of theme (Forman, Creswell, Damschroder, Kowalski, & Krein, 2008; Vaismoradi, Jones, Turunen, & Snelgrove, 2016). For the purpose of the study **thematic analysis** was used to analyze the qualitative data analysis.

## FINDINGS

Respondents were asked about their understanding of the concepts of staycations and the purposed of staycation. Most respondents expressed a positive reaction to staycation, as it is essential in everyday life and has both positive and negative effects.

### The Concept Of The Staycation Among Millennial Groups In Malaysia

After seven interviews, four themes were identified: duration, type of activity (leisure activities and visiting family), place (hotel or resort), and distance (near to home). Most respondents understood the concept, with the duration being a short period, the type of activity being leisure activities, the place being a hotel or resort, and the distance being near to home.

Table 4.2 shows the summary of the result analysis.

Theme	Sub Theme	Example Of Responses
<b>1. Duration</b>	Short Period	R1: "A person who leaves home to go somewhere with a purpose in a short period of time."  R3: "... a staycation can be defined is a short stay or less than three days."
<b>2. Type Activity</b>	Leisure Activity	R2: "Independence Day celebrations, went camping, and even participated in a concert"

	Visiting Family	R3: “Visiting parents and relatives, traveling to new places, and trying new foods.”  R4: The purpose for a staycation is to visit family, and spend time with family”
<b>3. Place</b>	Hotel or resort	R3: “every time they visit their parents, usually opting for a 2-day 1-night or 3-day 2-night stay at a hotel.”  R1:” Resorts and pools with beaches.”
<b>4. Distance</b>	Nearby from Home	R3: “The respondent's staycation location is to visit family but stay at a hotel or homestay for privacy because of their kids”

According to table 4.2, there were four main themes to explain the concepts of staycation among respondents. This study found a staycation can be referred to “*the activity of making a vacation out of staying at home*” (Sharma, 2009) and the new term was first used by Massey (2003). In general, the concept of a staycation refers to traveling to destinations closer to home within the context of tourism.

## TYPES OF PLACES FOR STAYCATION

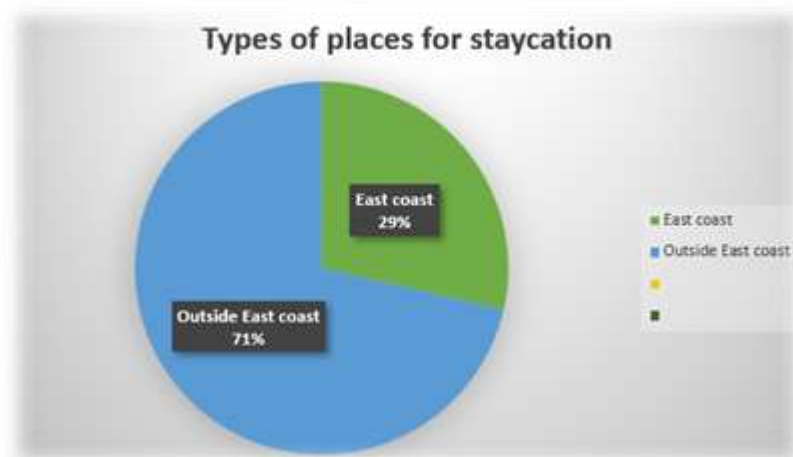

Diagram 4.1: Types of places for a staycation

The chart above depicts several types of destinations for staycation, which is an overview provided by multiple responders. The chart depicts the numerous locales that are suited for their staycation lodging. The described location is divided into two parts, the east coast, and the outside east. Based on their tastes and interests, responders can enjoy a wide range of venues in this situation.

According to the graphic, many respondents choose to spend their staycation somewhere other than the East Coast. This is owing to a number of external attractions located outside of the East Coast.

For example, R2 and R6 identified Kuala Lumpur as their ideal destination for a staycation, and R5 mentioned Penang as one of the intriguing places to visit. While R3 and R1 chose a location outside of Kelantan to see their families in their homeland and look for a beachfront hotel resort. This finding is supported by Rosu (2020) that found the length of a staycation is often short, as it mostly pertains to excursions within driving distance from home. Rosu (2020) interpreted that staycation as a temporary vacation spent at home or in one's hometown.

## PURPOSE OF STAYCATION

Table 4.3 shows the purpose of a staycation.

Purpose Of Staycation	Percentage (%)
➤ Spend time with family.	45%
➤ Release stress	30%
➤ Lifestyle	25%

Most of the respondents explained their purpose of staycation. For instance, R1 explained based on her experience, *“Staycation is to release stress, spend time with family, and find resorts and pools with beaches”*. R2 said.

*“She is a married couple (Long Distance Learning). They plan to go on vacation together during holidays to spend quality time with their family...”*

In terms of releasing their stress, R4 stated that *“staycation can release stress from work and wants to spend time with the family, looking for a 'viral' food port is also a cause for a staycation and finally the children also influence for staycation”*. R5 stated that *“He makes a staycation to desire to unwind after a long day of work, relax, lose their desire to work, shop, and find tasty cuisine”*. This finding of the staycation purpose is supported by Pawłowska-Legwand and Matoga (2016) that found a staycation is a new tourism trend, especially for city dwellers, because of changing lifestyle and work-life balance preferences. People might tend to avoid spending much time planning and waiting all year for a vacation, which makes them feel fatigued and focus on it with great expectations.

## IMPACT OF CRISIS ON A STAYCATION

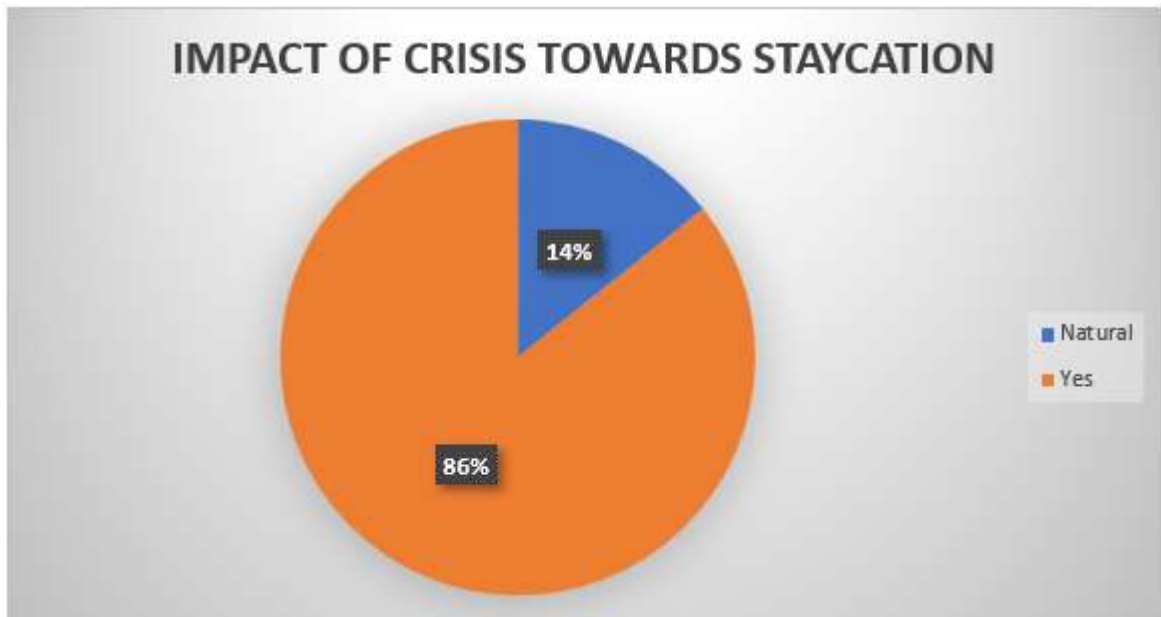

Figure 4.2: Impact of crisis on staycation

The graphic above depicts the impact of the crisis on staycation, it is apparent that daily living has an impact on the crisis. This is due to the fact that staycation has had a big impact since the crisis. Staycations, spent at home or in one's local neighborhood, have become a popular option for people wishing to get away from their routine without traveling far. This circumstance is demonstrated by the responses given to two groups, namely "natural and yes.

## LEVEL STRESS BEFORE AND AFTER STAYCATION

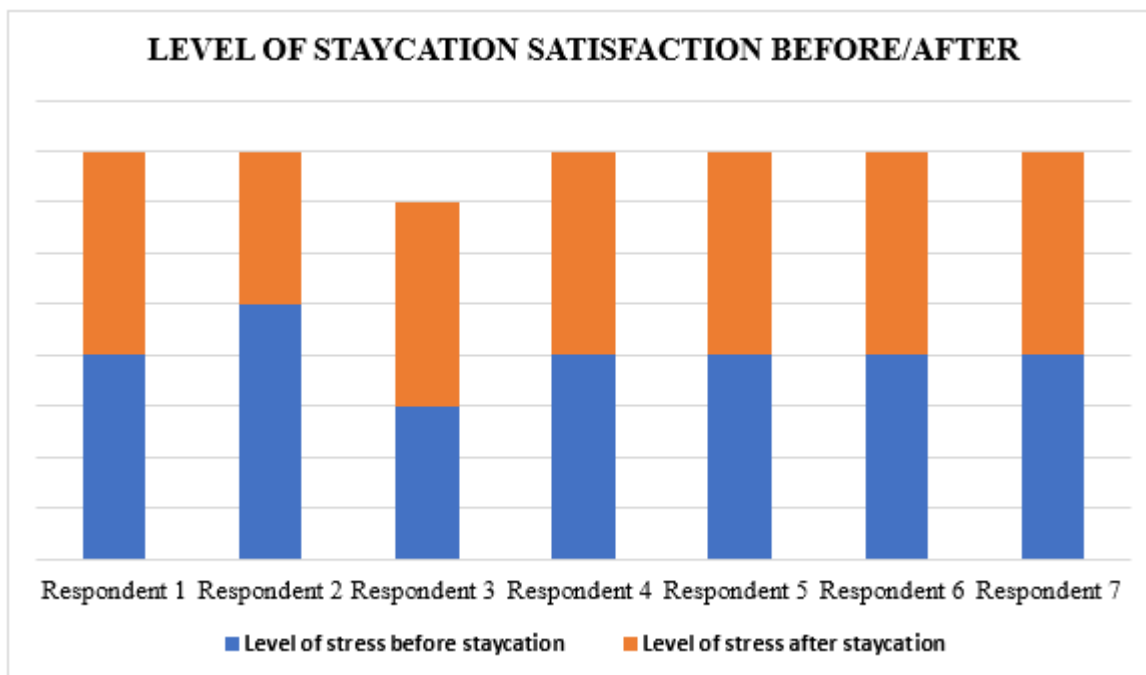

Figure 4.1: Level of staycation satisfaction before and after the crisis

## DISCUSSION AND RECOMMENDATION

### Discussion

Tourist well-being is influenced by the concept of staycation, which promotes recuperation and recovery from daily exhaustion. Staycations can help prevent severe health problems like depression, stress, trauma, and fear during the pandemic. Factors influencing Millennials' decision to staycation include stress relief, family time, and lifestyle changes. Staycation, a term used by Millennials, refers to leisure activities within driving distance of home, without overnight accommodation. This trend is popular among tech-savvy individuals who are more likely to try new things and travel. This finding result is supported by Pawłowska-Legwand and Matoga (2016), a staycation is a new tourism trend, especially for city dwellers, because of changing lifestyle and work-life balance preferences. Staycations are often shared with friends and family through social media platforms like Instagram, allowing them to experience the local area as a tourist without the time and expense associated with long-distance travel.

Staycation has become a popular trend during the Covid-19 pandemic, with studies showing short durations, leisure activities, and a focus on places. This trend has been particularly popular among city dwellers due to changing lifestyles and work-life balance preferences. The pandemic has imposed travel restrictions, forcing tourists to choose nearby destinations and avoid crowded places. Staycation has become a viable adaptation of tourism and hospitality activities, addressing mobility and access restrictions, and addressing immature recovery schemes like the "tourism bubble." "Millennials' staycation experiences during COVID-19 may differ from traditional travelers, as they explore local hotels and attractions in a restricted setting. This can lead to a shift in social circle behavior, as they assume the role of tourists exploring the neighbourhood. The pandemic has impacted millennials' decision to have a staycation, as the increased stress levels and lack of travel opportunities have led to a higher desire to release stress through staycations.

## **Recommendation**

Staycations have become increasingly popular as an alternative to typical holidays, particularly in the aftermath of the COVID-19 pandemic. However, particularly in the academic environment, there is still a considerable gap in academic research on the consequences and outcomes of staycations. Qualitative research can help future researchers investigate the aspects and dimensions of staycation experiences. Through in-depth interviews, focus groups, and observation, researchers can collect extensive, nuanced data on the elements that contribute to tourist happiness during staycations. They can look into the several parts that constitute the staycation concept, such as relaxation, local discovery, cultural immersion, and tailored experiences. Using qualitative approaches, researchers can dive into the subjective impressions, motives, and actions of staycationers, providing significant insights into their preferences and expectations.

After qualitative research has identified the important features of staycation experiences, quantitative research can be done to evaluate these factors and analyze their impact on tourist satisfaction. Surveys and questionnaires can be used by researchers to obtain quantitative data on a broader scale, allowing them to quantify and examine the correlations between different factors. Researchers, for example, can investigate the effect of hotel quality, proximity to attractions, leisure activity availability, and affordability on tourist satisfaction during staycations. By combining qualitative and quantitative methodologies, researchers can acquire a more thorough and solid knowledge of staycations.

While quantitative research allows for statistical analysis and variable measurement and provides empirical support for the conclusions, qualitative research dives into the components and dimensions of staycation experiences. By presenting a more comprehensive understanding of staycations, this mixed-methods approach can assist destination managers, policymakers, and stakeholders in designing and promoting fun and fulfilling staycation experiences.

## **CONCLUSION**

To conclude, considering a staycation is defined as "a vacation in which the vacationer stays at home, or near home while creating the ambiance of a standard vacation" in this section, millennials' staycation experiences at COVID-19 may differ from those of traditional travellers. A person on a staycation explores the local hotel's physical surroundings and visits nearby attractions rather than traveling to another region. Millennials' decisions to have a staycation are impacted by several circumstances or reasons, especially during the pandemic.

## **REFERENCES**

- Akter, M., Sadekin, M. N., & Patwary, A. K. (2020). An Empirical Study on Students' Satisfaction from Mawlana Bhashani Science & Technology University, Bangladesh. *Review of Economics and Development Studies*, 6(2), 363-379.
- Al Mahmud, S. R. (2020). The effectiveness of Facebook advertisements on purchase intention of customers in Malaysia. *South Asian Journal of Social Sciences and Humanities*, 1(1), 97-104.
- Alom, S., Patwary, A. K., & Khan, M. M. H. (2019). Factors affecting the turnover intention of Bangladeshi migrants in the United Arab Emirates: An empirical study on the hotel industry. *International Journal of Innovation, Creativity and Change*, 8(3), 344-360.

- Baron, J., & Goodwin, G. P. (2020). Consequences, norms, and inaction: A critical analysis. *Judgment and Decision making*, 15(3), 421-442.
- Bernamea. (2020, October 9). AirAsia, AirAsia X tamatkan khidmat lebih 2,000 pekerja. Didapatkan dari BH Online: <https://www.bharian.com.my/bisnes/korporat/2020/10/740263/airasia-airasia-x-tamatkan-khidmat-lebih-2000-pekerja>
- Besson, A. (2017). Everyday aesthetics on staycation as a pathway to restoration. *International Journal of Humanities and Cultural Studies*, 4.
- Choirisa, S. F. (2021). Understanding the Multiple Factors Determining of Generation Z to Hotel Staycation During Covid-19 Pandemic. *Jurnal Pariwisata Terapan*.
- Cvelbar, L. K., & Ogorevc, M. (2020). Saving the tourism industry with staycation vouchers. *Emerald Open Research*, 2(65), 65.
- Diaz-Soria, I. (2017). Being a tourist as a chosen experience in a proximity destination. *Tourism Geographies*, 19(1), 96-117.
- Elengoe, A. (2020). COVID-19 outbreak in Malaysia. Research Gate.
- Elliott, C. (2020, September 4). The Surprising Reason Staycations Are The New Vacations. Didapatkan dari Forbes: <https://www.forbes.com/sites/christopherelliott/2020/09/04/the-surprising-reason-staycations-are-the-new-vacations/?sh=5335722e140a>
- Fengmin, Z., Baijun, W., Jiangtao, B., Li, L., & Patwary, A. K. (2022). Investigating revisit intention of medical tourists in China through nutritional knowledge, perceived medical quality, and trust in the physiologist: A recommendation on health tourism policy measures. *Frontiers in Public Health*, 10, 893497.
- Guadagna, S., Barattini, D. F., Rosu, S., & Ferini-Strambi, L. (2020). Plant extracts for sleep disturbances: A systematic review. *Evidence-Based Complementary and Alternative Medicine*, 2020.
- Halid, S. A. (2020, March 13). RM3.37 bilion kerugian sektor pelancongan akibat COVID-19. Didapatkan dari [bharian.com: https://www.bharian.com.my/berita/nasional/2020/03/665159/rm337-bilion-kerugian-sektor-pelancongan-akibat-covid-19](https://www.bharian.com.my/berita/nasional/2020/03/665159/rm337-bilion-kerugian-sektor-pelancongan-akibat-covid-19)
- Hazbar, A. M. H., Alem Mohammed, A., & Karim, A. K. A. (2019). An Empirical Study of Factors Influencing hotel customers' online booking Intention. *الإنسانية الدراسات و التربوية العلوم مجلة*, (5), 1-17.
- Hsieh, H. F., & Shannon, S. E. (2005). Three approaches to qualitative content analysis. *Qualitative health research*, 15(9), 1277-1288.
- Jeurig, J. H. G., & Haartsen, T. (2017). The challenge of proximity: the (un) attractiveness of near-home tourism destinations. *Tourism Geographies*, 19(1), 118-141.
- Kelly, M., Dowling, M., & Millar, M. (2018). The search for understanding: The role of paradigms. *Nurse researcher*, 25(4), 9-13.
- L. Meng1, F. H. (2020). *Coronavirus Disease 2019 (COVID-19)*: Adobe PDF Library.
- Lai, A., Lipka, S., Kumar, A., Sethi, S., Bromberg, D., Li, N., ... & Brady, P. (2018). Role of esophageal metal stents placement and combination therapy in inoperable esophageal carcinoma: a systematic review and meta-analysis. *Digestive diseases and sciences*, 63, 1025-1034.
- Lew, A. A., Cheer, J. M., Haywood, M., Brouder, P., & Salazar, N. B. (2020). Visions of travel and tourism after the global COVID-19 transformation of 2020. *Tourism Geographies*, 22(3), 455-466.
- Li, L., Ragavan, N. A., Patwary, A. K., & Baijun, W. (2022). Measuring patients' satisfaction toward health tourism in Malaysia through hospital environment, nutritional advice, and perceived value: A study on Chinese exchange students. *Frontiers in public health*, 10, 893439.
- Li, L., Wu, B., & Patwary, A. K. (2022). How marine tourism promote financial development in sustainable economy: new evidences from South Asia and implications to future tourism students. *Environmental Science and Pollution Research*, 29, 1155-1172.



- Li, L., Wu, B., & Patwary, A. K. (2022). The psychosocial factors affecting chinese Outbound Exchange and mobility students' academic performance during COVID-19. *Frontiers in psychology*, 13, 872516.
- Lin, Z. C., Wong, I. A., Kou, I. E., & Zhen, X. C. (2021). Inducing wellbeing through staycation programs in the midst of the COVID-19 crisis. *Tourism management perspectives*, 40, 100907.
- London, A. J., & Kimmelman, J. (2020). Against pandemic research exceptionalism. *Science*, 368(6490), 476-477.
- Milano, C., Novelli, M., & Cheer, J. M. (2019). Overtourism and tourismphobia: A journey through four decades of tourism development, planning and local concerns. *Tourism Planning & Development*, 16(4), 353-357.
- Molz, J. G. (2009). Representing pace in tourism mobilities: Staycations, slow travel and the amazing race. *Journal of Tourism and Cultural Change*, 7(4), 270-286.
- Moon, H., & Chan, H. (2022). Millennials' staycation experience during the COVID-19 era: mixture of fantasy and reality. *International Journal of Contemporary Hospitality Management*, (ahead-of-print).
- Muritala, B. A., Hernández-Lara, A. B., Sánchez-Rebull, M. V., & Perera-Lluna, A. (2022). # CoronavirusCruise: Impact and implications of the COVID-19 outbreaks on the perception of cruise tourism. *Tourism Management Perspectives*, 41, 100948.
- Official Portal: Ministry of tourism, a. a. (2023, January 10). List of Travel Operating Business and Travel (TOBTAB). Didapatkan dari Official Portal: Ministry of tourism, arts and culture: <https://www.motac.gov.my/en/check/tobtab>
- Patwary, A. K., Roy, B., Hoque, R., & Khandakar, M. S. A. (2019). Process of developing a community based tourism and identifying its economic and social impacts: An Empirical study on Cox's Bazar, Bangladesh. *Pakistan Journal of Humanities and Social Sciences*, 7(1), 1-13.
- Pawłowska-Legwand, A., & Matoga, Ł. (2016). Staycation as a way of spending free time by city dwellers: examples of tourism products created by Local Action Groups in Lesser Poland Voivodeship in response to a new trend in tourism. *World Scientific News*, 51.
- Romagosa, F. (2020). The COVID-19 crisis: Opportunities for sustainable and proximity tourism. *Tourism Geographies*, 22(3), 690-694.
- Rosala, M. (2022, August 17). How to Analyze Qualitative Data from UX Research: Thematic Analysis. Didapatkan dari Nielsen Norman Group logoNielsen Norman Group.
- Rudd, M. D., Berman, A. L., Joiner Jr, T. E., Nock, M. K., Silverman, M. M., Mandrusiak, M., ... & Witte, T. (2006). Warning signs for suicide: Theory, research, and clinical applications. *Suicide and Life-Threatening Behavior*, 36(3), 255-262.
- Sadaghiani, K. K. (2010). Millennials in the Workplace: A Communication Perspective. *Springerlink.com*, 1.
- Sadaghiani, K. K. (2010). Millennials in the Workplace: A Communication Perspective on Millennials' Organizational Relationships and Performance. *Springer Link*.
- Sanchez-Rebull, B. A.-B.-L.-V. (2022). COVID-19 staycations and the implications for leisure travel. *Heliyon*.
- Sharma, S. (2009). The great American staycation and the risk of stillness. *M/C Journal*, 12(1).
- Stylidis, D., Belhassen, Y., & Shani, A. (2017). Destination image, on-site experience and behavioural intentions: Path analytic validation of a marketing model on domestic tourists. *Current Issues in Tourism*, 20(15), 1653-1670.
- Sumethokula, P., Patwary, A. K., Srinuanpanc, B., Srinuanpand, C., Suwandee, P., Thammathikul, A., & Phanong, W. (2020). The potential of new tour repackaging for creative tourism among entrepreneurs in Nakhon Si Thammarat. *International Journal of Innovation, Creativity and Change*, 13(10), 1752-1771.

- Todman-Lewis, C. V. (2017). Strategies for crisis preparedness of tourist destinations (Doctoral dissertation, Walden University).
- University, J. K. (2021/2022). Assignment the differences between qualitative research and quantitative research analysis methods. Didapatkan dari studocu: <https://www.studocu.com/row/document/jomo-kenyatta-university-of-agriculture-and-technology/research-methods/assignment-the-differences-between-qualitative-research-and-quantitative-research-analysis-methods/36672929>
- Virginia Braun, V. C. (2012). Thematic analysis. Reseach Gate.
- Wu, B., Liu, S., Wang, J., Tahir, S., & Patwary, A. K. (2021). Assessing the mechanism of energy efficiency and energy poverty alleviation based on environmental regulation policy measures. *Environmental Science and Pollution Research*, 28, 40858-40870.
- Wu, B., Zhai, B., Mu, H., Peng, X., Wang, C., & Patwary, A. K. (2021). Evaluating an economic application of renewable generated hydrogen: A way forward for green economic performance and policy measures. *Environmental Science and Pollution Research*, 1-15.
- Yosra A. Helmy 1, 2. ,. (2020). The COVID-19 Pandemic: A Comprehensive Review, of Taxonomy, Genetics, Epidemiology, Diagnosis, Treatment, and Control. *Clinical Medicine*.
- Z.Lin, I. A. (2021). Inducing wellbeing through staycation programs in the midst of the COVID-19 crisis. Research Gate.
- Zulkifli, A. (2021). Travel bubble task force ready to welcome international tourists. *New Straits Times*.
- Zulu, B. S. (2019). Factors facilitating and inhibiting contraceptive use among White University students in Durban South Africa (Doctoral dissertation).

# THE EFFECT OF A SHORT VACATION ON WORK STRESS AMONG TOURISM LECTURERS

NUR 'ARIFAH ZAHIRAH BINTI ZAHARIN, NUR ADLIN FARIZAH BINTI AZMAN,  
NUR ADRIANA HUSNA BINTI MOHD ISA, NUR AFIFAH BINTI RADZALI, DR. NOR  
SYUHADA BINTI ZULKEFLI

*Faculty of Hospitality, Tourism and Wellness, University Malaysia Kelantan*  
*Corresponding email: [syuhada.z@umk.edu.my](mailto:syuhada.z@umk.edu.my)*

---

## ABSTRACT

A short vacation usually refers to a short period spent away from home or work for leisure or recreation. It is a relatively short break or vacation, usually between a few days to a week, created to provide relaxation, tranquillity, and freedom. A short vacation can take many forms depending on individual preferences and circumstances. A short vacation offers an opportunity to disconnect from work-related stress. By taking leave, lecturers can stay away from work for a while to avoid work pressure. Based on the topic, we studied the effect of a short vacation on the stress level of lectures, especially lectures that teach in the field of tourism related. Therefore, this study aims to investigate the impact of short vacations on work stress among tourism lecturers. The research uses a semi-structured set of questions and an exploratory methodology, starting with in-depth interviews. When it reaches saturation points, data is collected. Thematic analysis is a technique for data analysis based on themes that appear in interviews, and it will be used for these types of interviews. Any number of formats, including transcripts from interviews, field notes, policy documents, images, and videos, could be used to represent the data that is being analyzed. Consequently, the main drawback of this study is the limited sample size, however impressive results were ultimately attained.

**Keywords:** Short Vacation, Lecturers, Stress, Destination, Workplace, Education.

---

## INTRODUCTION

Globally the 21st-century workplace is a dynamic, complex, fast-paced highly challenging environment. Given the increasingly global character of the service industry and the competitiveness of the knowledge era, critical actors such as university professors are frequently under pressure. While moderate stress might improve performance, excessive stress can have harmful implications (Usoro, 2018). The functions of lecturers across the world are to produce ideas, improve human resource capability, and provide services.

*Lecturers* play a critical role in higher education since they represent their schools and determine the quality of instruction and learning. Furthermore, professors organize and convey to university students their specialized subject matter. This involves producing tutorials, marking assignments, and providing educational materials, instead of direct teaching. Also, they attend conferences as part of their study and publish books, articles, and other materials to convey their expertise. According to Tan (2019), the duty of a lecturer follows, which includes meeting with students individually to discuss progress, inspecting and assessing students' work, doing research, and interviewing students. Tan (2019) describes the role of a lecturer as "meeting students individually to discuss progress, checking and assessing students' work, pursuing research, out administration, such as attending faculty meetings and writing reports, planning to teach, and so on.

The word *workplace* refers to the physical location or environment in which individuals perform their jobs or work-related activities (Bhui, 2016). It is the context in which employees do their job tasks, engage with co-workers, and contribute to the organization's goals and objectives. Workplaces can differ significantly based on the sector, organization, and job type. They can include places like offices, factories, retail stores, hospitals, schools, and construction projects. In recent years, the definition of a workplace has broadened to encompass virtual or remote work settings in which workers may work from home or any other location by utilizing digital technology and online communication tools.

*Work stress* is defined as the physical, emotional, and mental strain that people suffer because of work-related pressures and responsibilities. It happens when a person's ability to cope with the demands of the work is exceeded, resulting in emotions of overwhelm, tiredness, and discontent (Hogan et al., 2022). While some degree of workplace stress is natural, prolonged, or severe workplace stress can have negative impacts on both physical and mental well-being. It can lead to burnout, exhaustion, lower productivity, and a range of health problems. Employers like lecturers also have a role to play in managing and reducing work stress by promoting a supportive work

environment, providing resources for stress management, fostering work-life balance, and addressing factors that contribute to stress. Employers like lecturers also have a role to play in managing and reducing work stress by promoting a supportive work environment, providing resources for stress management, fostering work-life balance, and addressing factors that contribute to stress.

A *short vacation* refers to a short period of time in which individuals take a break from their normal routines and responsibilities. Unlike longer vacations that may span several weeks or months, short vacations are usually shorter in duration, ranging from a few days to a week. They offer an opportunity to escape from the demands of work or study, rest and recharge. Individuals can choose to go on a short vacation alone, with a partner, family or friends. A short vacation can take many forms, depending on personal preferences and interests. Because of their shorter duration, short vacations are often more feasible and easier to plan than longer vacations. It can be scheduled during weekends, public holidays or times when individuals have several days off from work or school in a row. This makes short vacations a convenient option for individuals who may have limited downtime or find it difficult to be outside for extended periods (Abu Bakar, 2020). This job pressure might have an impact on their productivity. Teaching, publishing, and community service are all examples of occupations. This issue may be resolved in the future if people see the value of brief vacations in providing lecturers with new energy and happiness, allowing them to build a more educated and creative teaching force for the following phase of lectures.

Therefore, a short vacation provides a valuable opportunity to temporarily step away from the demands of everyday life and enjoy leisure, exploration, and self-care. This study aims to explore the relationship between short vacations and job stress.

### **Research Objectives:**

1. To identify the factors that encourage lecturers to take vacations.
2. To study the role of short vacations among lecturers.
3. To explore the potential of a short vacation to reduce work stress among lecturers.
4. To identify whether a short vacation is effective in relieving stress among lecturers.

### **SIGNIFICANCE OF THE STUDY**

Education is also characterised by a developing educational style. When developing workplace interventions, the conceptualization of work stress is absolutely essential. Work-related stress has been

defined as "a harmful reaction that humans have to undue stress and pressure at work." (Bhui K, 2016). Almost everyone tends to agree that job stress is caused by the communication between the worker and the working conditions. The next research goal is to raise awareness of short vacations in order to minimize workplace stress among lecturers. Short vacations may help and benefit employees in a variety of ways, including enhancing mindfulness and improving health.

Short vacations for lecturers in the field of tourism offer many benefits that positively impact personal and professional life. It is important for lecturers to prioritize self-care, engage in activities that inspire them, and seek opportunities for growth. By investing in short vacations in tourism, educators can improve their well-being, and teaching effectiveness and ultimately provide their students with a more enriched and diverse educational experience.

The findings of the study reveal some significant pressures faced by lecturers. These stressors include heavy workloads, long working hours, lack of job security, limited opportunities for career advancement, and difficulty balancing work and personal life. Overall, this study contributes to raising awareness of the work pressures faced by lecturer faculty members and policies aimed at improving their well-being and job satisfaction in higher education environments.

## **LITERATURE REVIEW**

### **The Concept of Stress**

This literature review aims to review the relevant literature and research related to work stress and a short vacation. First, discuss the concept of stress. Stress is a response to anything that requires our focus or action. Any amount of experience is common. However, our general well-being is significantly impacted by how we handle stress. 2019 (MyBib Contributors, 2019).

### **The Challenges of Higher Education during The Crisis**

The second is higher education challenges during the crisis, the novel coronavirus illness 2019 (COVID-19) spread to other nations in early 2020 after the first cases were reported in Wuhan, China, in December 2019. As a result, universities around the world either canceled all on-campus events like conferences, workshops, sports, and other events or quickly converted many courses and

programme from a traditional classroom setting to an online one. In order to prevent the virus from spreading in academic settings, the Ministry of Education needs to be able to confirm that all professors are engaged in online teaching and learning.

### **The Concept of a Short Vacation**

The third is about the concept of a short vacation. Short vacations are typically less than seven days. Short vacations are more common than long vacations. Long breaks are only available once or twice a year, whereas short vacations can be taken on weekends, extended weekends, and other public holidays combined with weekends day.

### **The Relationship between Short Vacation and Stress Release**

The fourth is about the relationship between short vacations and stress release. Research shows that a good vacation can lead to the experience of fewer stressful days at least five weeks later. This is to say, vacations are a gift that never ends (Scott, 2020). Four-day long weekends or short vacations improved well-being, recovery, tension, and perceived stress for up to 45 days.

### **Research Conceptual**

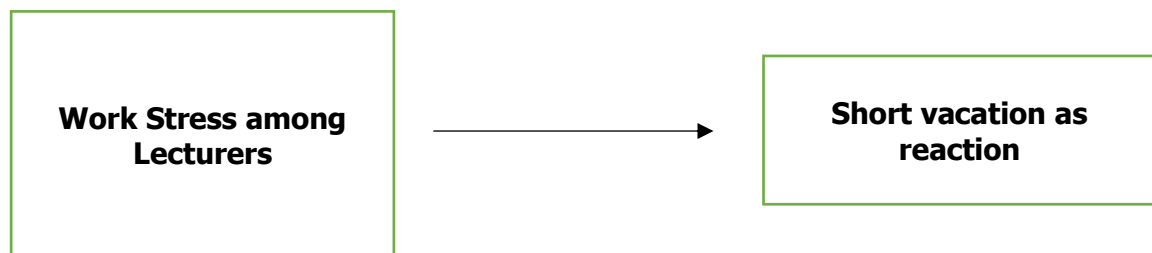

**Figure 1.0: The concept of work stress and short vacation as a reaction.**

## **METHODOLOGY**

### **Research Design**

The research design used for collecting data in this study is the interview method to collect all the data to meet the qualitative study requirements. This method is used for researchers to focus on a specific question, and ethically. So, this method's answer is more likely to be valid, thrust-worthy, and useful for the research result by only consuming less time and cost. The qualitative approach is a technique for understanding an individual's ideas, feelings, views, and the causes underlying these emotions. It is used to gather precise and exhaustive information on a certain subject. The data is

being gathered to examine the impact of a brief vacation on job stress reduction among tourism lecturers. As a result, we use the inductive technique in this research.

### **Data Collection**

The data procedure in this qualitative approach study is an interview. This procedure aids in the data collection of more exact data for the research’s few phases that must be accomplished. This procedure aids in the collection of more accurate data throughout the inquiry. The next step in data collection is to gather measurements. The interviews are just for lecturers at UMK Campus Kota. Five lecturers from Faculty Hospitality, Tourism, and Wellness (FHPK) are targeted in this study. This simplifies obtain in gain more precise information about the advantages and significance of brief vacations for lecturers. Following the collection of all data, it will be measured to identify the best and most accurate data. Interviews are then utilized to determine whether most lecturers say the same thing in response to each question asked by the researcher. If the researcher gets enough same answers from the interview, then the interview will end.

**Table 3.1: Research question for exploring the potential of staycation as one prefers a destination to travel to during and in aftermath of the covid-19.**

<b>Research questions</b>	<b>Research approach</b>	<b>Respondents</b>
1. What are the key factors that encourage lecturers to take short vacations	Semi-structured interview	Lecturers
2. How can a short vacation help relieve lecturer stress?		



3. How can the staycation be one preferred travel choice during and in the aftermath of the Covid19?		
--	--	--

**Sampling**

This research are using the purposive sampling method to obtain the data from this interview. The purpose of this study and its case studies is to investigate the possibility of short vacations as a preferred location for lecturers to relieve job stress. With that, we'll select five tourism instructors from the Faculty of Hospitality, Tourism, and Wellness at the University Malaysia Kelantan campus Kota in Pengkalan Chepa, Kelantan. The respondents are lecturers in the Faculty of Hospitality, Tourism, and Wellness, and the sample will be drawn from 5 lecturers who teach tourism courses and occupy diverse positions in the university. These five lecturers will take this sample to demonstrate the data pointed in this research.

**Data Analysis**

There are many different data analysis techniques available within the qualitative method. The tools at hand include event structure analysis, thematic analysis, domain analysis, constant comparison, successive approximation, matrices, grounded theory, and other analytical techniques (Silverman, 2006). So, in this research, the researcher uses the thematic analysis technique under the qualitative data for Looking through a data set to uncover, analyse, and document reoccurring themes. It is a technique for describing data, but it also includes interpretation when identifying patterns as well as creating themes. One of theme analysis's distinctive features is its ability to be used within a wide range of theoretical and epistemological frameworks, as well as to be applied to a wide range of research topics, designs, and sample sizes.

**FINDINGS**

Based on the investigation carried out during the interview, the following findings are drawn. A group of instructors from the Faculty of Hospitality, Tourism, and Wellness who hold various positions in tourism-related fields makes up the responder. In this study, we discovered that lectures require a little break to relieve work stress.

The objective of the research is to determine whether lecturers would prefer brief vacations as a way to decompress from their jobs. Determining the characteristics that motivate lecturers to take a vacation is one of the study's specific goals. To investigate lecturers' approach to short vacations. Lecturers might spend time to contemplate and reflect during their short holidays. They might take a break from their regular activities to assess their career goals and make future plans.

Other than that, to look into the viability of a short break to reduce lecturers' stress from work. Lecturers can temporarily escape their employment obligations by taking a short vacation. They are able to emotionally and physically detach from the demands and stress of their work during this time away.

## RESULT ANALYSIS

**Table 4.2: Summary of result analysis**

<i><b>THEMES</b></i>	<i><b>SUB-THEMES</b></i>	<i><b>EXAMPLE OF RESPONSES</b></i>
<b>A LOT OF TASKS</b>	<b>INSUFFICIENT TIME</b>	R2 - "Insufficient time or time limits make it difficult to finish every task because lecturers also conduct research, provide community activities, and more."

	<b>MANY JOBS TO BE DONE</b>	R1 - "Too many tasks need to be finished, which is the main issue. It can be challenging when administration requires more other work than teaching."
<b>APPLICATION OF NEW SYSTEM</b>	<b>A NEW SYSTEM</b>	R3 - "The issue is present in numerous systems, including e-learning, e-campus, and others. The best course of action is to become familiar with the systems, then ask friends for help and learn how to utilize the application."
	<b>JOB CONSTRAINTS</b>	R6 "There is pressure, as well as the workload of working as a lecturer."
<b>PERSONAL MATTERS</b>	<b>UNBALANCE LIFE</b>	R5- "The difficulty encountered is that it is hard to divide time between life and work; the stress grows as a result of our inability to divide time. When several problems cannot be resolved, there will be many conflicts with others, which may cause an impact on a person's mind-set."
		R6- "Work contributes to stress because of a heavy schedule and the need to handle personal concerns while working"

### Impact of Short Vacation on Reduce Stress Towards Lecturers

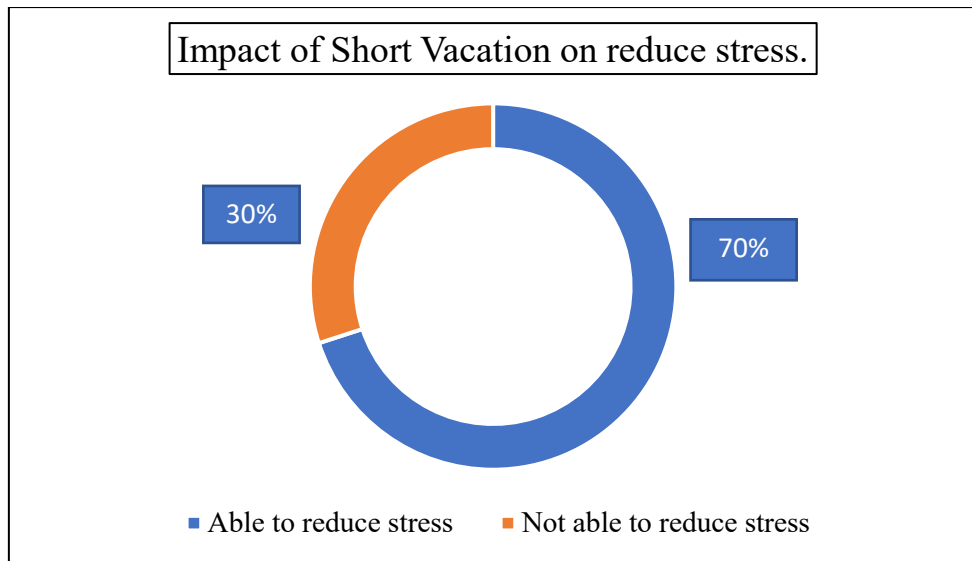
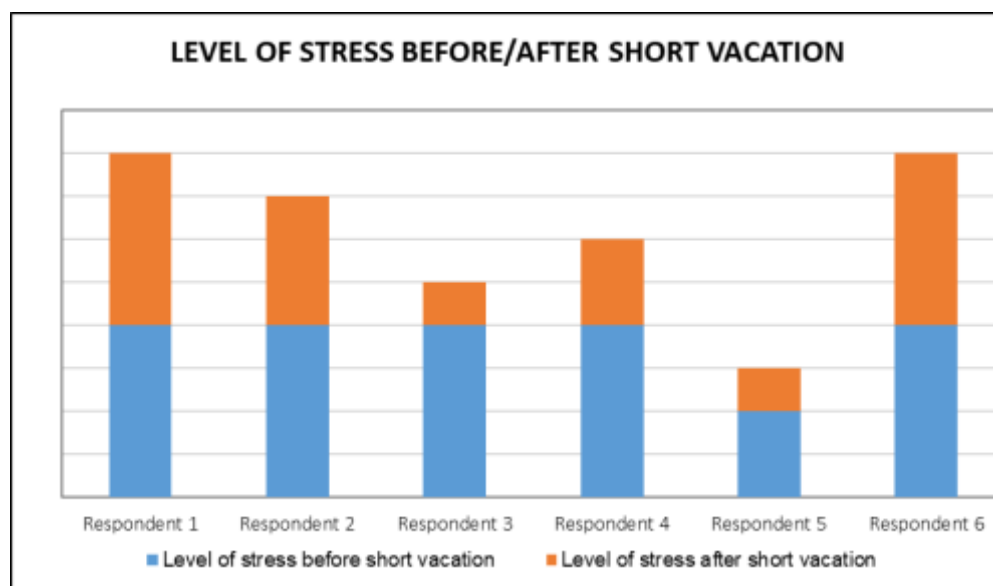

Figure 4.3 shows the bar chart percentage result on the impact of short vacations on reducing stress among tourism lecturers.

The bar chart above the top illustrates how taking a short vacation helped tourism lecturers feel less stressed after returning from their trip. This is because short vacations have a significant influence on helping lecturers lower their working stress. This can be determined from the percentage, which reveals that 70% of respondents agree that short vacations can help them reduce stress, whereas 30% stated the contrary, short vacations cannot help them to reduce their stress because of certain reasons and this is including the different experiences during their vacation, which not meet their expectation and needs as well as a lack of time to spend more time on short vacations because of management-assigned tasks.

## LEVEL OF STRESS AMONG LECTURERS BEFORE AND AFTER A SHORT VACATION



**Figure 4.1: Level of stress before and after of short vacation.**

## DISCUSSION AND RECOMMENDATION

### Discussion

Stress-related factors affecting lecturers' jobs, this part exemplifies the primary difficulty of the lecturers' work. Based on the data examined, this study's three primary themes—a lot of chores, trouble adjusting to new systems, and problems with personal matters—were identified. This research is aligned that Stress can be divided into chronic and acute. Given the differences between acute and chronic stressors, they may differ in their relations with individual strains and performance (Omair et al., 2019). The term "short vacation" describes a brief length of time spent away from home or a job for leisure or enjoyment. It is a short vacation or break, typically lasting a few days to a week, designed to promote rest, tranquility, and freedom.

As to solve the problem short vacation is known as one of the alternatives that can help these lecturers to reduce their stress, as short vacations known as one to four-day intervals are considered short vacations. The unreliable source was cited. Every employee finds it simple to take time off from work. Short trips are ideal for younger people or workaholics because they allow personnel to get away from high-stress jobs or from boredom so they can return to work after a few days of rest with renewed strength.

Vacations planned over the weekend or extended weekends are the exclusive focus of short vacations. Individuals can take a break from their normal routine during this time to quickly get over their fatigue by engaging in activities that can help to settle their minds, such as taking in the scenery or engaging in physical activity. Other than that, by taking a short vacation as an alternative for lecturers they can socialize, laugh, travel, engage in pleasant hobbies, engage in physical activity, and get enough sleep are just a few of the leisure activities that can reduce personal stress and come back stronger and fresher into the learning environment.

## **Recommendation**

The subsequent suggestions are given regarding this component of the recommendation in considering the work conducted during this study as well as the findings that have already been provided. The present investigation may be viewed as a first step in the examination of how brief vacations reduce the stress of lecturers. However, the results of this study should be regarded cautiously due to the small number of participants and the absence of information regarding the subject's demographics.

Further studies ought to concentrate further on how much stress undergraduates experience and how family vacations might help them rest. On top of that, depending on physiological and human aspects, it might increase the comprehension of the optimum location to go while under stress. The investigation also discovered that many faculty members did not have adequate vacation time since they had several or diverse tasks to complete and were unable to conduct lengthy interviews. Thus, it is advised that higher-ups convey to the lecturers a specified holiday or period of time so they may complete the assignment, spend time with family, and continue onward.

## **CONCLUSION**

Numerous short vacations, according to research, lead to greater and longer-lasting happiness. These results are consistent with the Broaden-and-Build Theory's premise that happy vacation experiences may increase a person's ability for stress management. One quick getaway can improve well-being and help individuals to decompress from stress.

To sum up, this study demonstrates that managing the investigation by identifying the work-stress elements among educators before and after when the short vacation and the varied types of stress in each lecturer. And both on an internal and external level, this can have a significant impact. For instance, a short vacation might relieve tension in lecturers, enabling them to instruct students more effectively because they are

still feeling the benefits of their most recent holiday. In the end, this study highlighted and clearly claimed that lecturers are able to benefit their self of peace by taking short vacations.

## REFERENCES

- Akil, B. S. (2019). Revisiting the Stress Concept: Implications for Affective Disorders. *Journal of Neuroscience*, 12-21.
- Akter, M., Sadekin, M. N., & Patwary, A. K. (2020). An Empirical Study on Students' Satisfaction from Mawlana Bhashani Science & Technology University, Bangladesh. *Review of Economics and Development Studies*, 6(2), 363-379.
- Alom, S., Patwary, A. K., & Khan, M. M. H. (2019). Factors affecting the turnover intention of Bangladeshi migrants in the United Arab Emirates: An empirical study on the hotel industry. *International Journal of Innovation, Creativity and Change*, 8(3), 344-360.
- Bhui K, D. S.-M. (2016). Perceptions of work stress causes and effective interventions in employees working in public, private and non-governmental organisations: a qualitative study. *National Library Of Medicine*.
- Blank C, G. K.-R. (2018). Short Vacation Improves Stress-Level and Well-Being. *International Journal of Environmental Research and Public Health*.
- Brennan, D. (2021, October 25). *How Travel Can Help Reduce Stress and Ease Anxiety and Depression*. Retrieved from WebMD: <https://www.webmd.com/mental-health/how-travel-affects-mental-health>
- Britannica, E. (2016). Higher Education . *Britannica*.
- BRM. (January). *Purposive sampling*. Retrieved from BRM: [https://research-methodology.net/sampling-in-primary-data-collection/purposive-sampling/#:~:text=Purposive%20sampling%20\(also%20known%20as,to%20participate%20in%20the%20study](https://research-methodology.net/sampling-in-primary-data-collection/purposive-sampling/#:~:text=Purposive%20sampling%20(also%20known%20as,to%20participate%20in%20the%20study).
- Castrillon, C. (2021). *Why Taking Vacation Time Could Save Your Life*. Retrieved from Forbes.
- Contributor, T. (2019, October 18). *What is Qualitative Data?* Retrieved from CIO: <https://www.techtarget.com/searchcio/definition/qualitative-data>
- Dive, D. (2022, November 15). *What is Qualitative Data? How to Understand, Collect, and Analyze it*. Retrieved from FullStory: <https://www.fullstory.com/qualitative-data/>
- Fengmin, Z., Baijun, W., Jiangtao, B., Li, L., & Patwary, A. K. (2022). Investigating revisit intention of medical tourists in China through nutritional knowledge, perceived medical quality, and trust in the physiologist: A recommendation on health tourism policy measures. *Frontiers in Public Health*, 10, 893497.
- Frye, L. (2018). *More People Are Taking Time Off, and That's Good for Business*. Retrieved from SHRM: <https://www.shrm.org/resourcesandtools/hr-topics/employee-relations/pages/workers-taking-more-vacation-.aspx>
- Hat, T. (2022, December 3). *Lecturer Definition and Meaning*. Retrieved from Top Hat. Ivan, S. (2021, April 1). *Qualitative Data Collection: 6 Things Researchers Need to Know to Get*

- it Right*. Retrieved from National Institute for Children's Health Quality :<https://www.nichq.org/insight/qualitative-data-analysis-7-things-researchers-need-know-get-it-right#:~:text=What%20is%20Qualitative%20Data%3F>
- Hazbar, A. M. H., Alem Mohammed, A., & Karim, A. K. A. (2019). An Empirical Study of Factors Influencing hotel customers' online booking Intention. *مجلة العلوم التربوية و الدراسات الإنسانية*, (5), 1-17.
- Jenet, N. (2015, August 9). *What's Better for You: Long or Short Vacations?* Retrieved from Healthy Travel Blog: <https://www.healthytavelblog.com/2015/08/06/whats-better-for-you-long-or-short-vacations/>
- Lee, T.-W. (2004). International students' travel decision making. *Rochester Institute of Technology*, 7.
- Li, L., Ragavan, N. A., Patwary, A. K., & Baijun, W. (2022). Measuring patients' satisfaction toward health tourism in Malaysia through hospital environment, nutritional advice, and perceived value: A study on Chinese exchange students. *Frontiers in public health*, 10, 893439.
- Li, L., Wu, B., & Patwary, A. K. (2022). How marine tourism promote financial development in sustainable economy: new evidences from South Asia and implications to future tourism students. *Environmental Science and Pollution Research*, 29, 1155-1172.
- Li, L., Wu, B., & Patwary, A. K. (2022). The psychosocial factors affecting chinese Outbound Exchange and mobility students' academic performance during COVID-19. *Frontiers in psychology*, 13, 872516.
- Nadezhda Almazova, E. K. (2020). Challenges and Opportunities for Russian Higher Education amid COVID-19: Teachers' Perspective. *MDPI*. Retrieved from <https://www.mdpi.com/2227-7102/10/12/368>
- Patwary, A. K., Roy, B., Hoque, R., & Khandakar, M. S. A. (2019). Process of developing a community based tourism and identifying its economic and social impacts: An Empirical study on Cox's Bazar, Bangladesh. *Pakistan Journal of Humanities and Social Sciences*, 7(1), 1-13.
- Point, T. (2022, December 29). *Tutorials Point*. Retrieved from Motivation Factors of the Tourists: [https://www.tutorialspoint.com/tourism\\_management/tourism\\_management\\_motivation\\_factors\\_of\\_tourists.htm](https://www.tutorialspoint.com/tourism_management/tourism_management_motivation_factors_of_tourists.htm)
- QuestionPro. (2018, April 19). *Qualitative Data: Definition, Types, Analysis and Examples*. Retrieved from QuestionPro: <https://www.questionpro.com/blog/qualitative-data/>
- Rasheed Mohammad Nassr, A. A. (2020). Understanding Education Difficulty During COVID-19 Lockdown: Reports on Malaysian University Students' Experience. *IEEEEXPLORE*.
- Scott, E. (2020, November 30). *Taking Vacations for Stress Relief and Overall Health*. Retrieved from Verywell Mind: <https://www.verywellmind.com/take-vacations-for-stress-relief-overall-health-3145274>
- SellMyTimeshareNow. (2019, February 6). *SellMyTimeshareNow*. Retrieved from Short Vacation Vs. Long Vacation: What is Best for You?: <https://www.sellmytimesharenow.com/blog/short-vacation-vs-long-vacation-what-is-best-for-you/>
- Stay, B. (2022, May 3). *Short Vacations Or Long Vacations? Which One Is Best For You?* Retrieved



from Bigfoot Stay: <https://www.bigfootstay.com/post/short-vacations-or-long-vacations#:~:text=One%20major%20dilemma%20is%20between,generally%207%20days%20or%20more>.

Steven Sauter, L. M.–F. (1999). Work Stress. *NIOSH*, 99-101.

Sumethokula, P., Patwary, A. K., Srinuanpanc, B., Srinuanpand, C., Suwandee, P., Thammathikulf, A., & Phanong, W. (2020). The potential of new tour repackaging for creative tourism among entrepreneurs in Nakhon Si Thammarat. *International Journal of Innovation, Creativity and Change*, 13(10), 1752-1771.

WHO. (2022, December 3). *Occupational health: Stress at the workplace*. Retrieved from World Health Organization: <https://www.who.int/news-room/questions-and-answers/item/occupational-health-stress-at-the-workplace>

Wu, B., Liu, S., Wang, J., Tahir, S., & Patwary, A. K. (2021). Assessing the mechanism of energy efficiency and energy poverty alleviation based on environmental regulation policy measures. *Environmental Science and Pollution Research*, 28, 40858-40870.

Wu, B., Zhai, B., Mu, H., Peng, X., Wang, C., & Patwary, A. K. (2021). Evaluating an economic application of renewable generated hydrogen: A way forward for green economic performance and policy measures. *Environmental Science and Pollution Research*, 1-15.

# THE IMPACT OF MEMORABLE ECO-TOURISM EXPERIENCE ON BEHAVIORAL INTENTION AMONG TOURISTS WHO TOOK TRAIN TRIPS TO DABONG, KELANTAN

Nur Afiqah binti Azman, Nur Afiqah binti Mohd Salleh, Nur Afni Fitriani binti Sufian, Nur Aiman Haina binti Hamidon, Nurzehan binti Abu Bakar

*Faculty of Hospitality, Tourism and Wellness, University Malaysia Kelantan  
Corresponding email: nurzehan.ab.@umk.edu.my*

---

## ABSTRACT

This study aims to explore the influence of memorable eco-tourism experiences on the behavioral intentions of tourists who have taken train trips to Dabong, Kelantan. Using a quantitative research approach, an online survey will be administered to 384 respondents who have visited this region in Malaysia. The results reveal that hedonism, novelty, meaningfulness, and knowledge are positively associated with tourists' behavioral intentions. This research stands out as the first investigation of memorable eco-tourism experiences towards ecotourism destination in Kelantan. The implications of this study are significant as it offers valuable insights to tour operators and tourism marketers on how to create and promote memorable eco-tourism experiences, ultimately enhancing tourist satisfaction.

---

**Keywords: Ecotourism, Memorable Tourism Experiences, Behavioral Intention, Tourist Satisfaction**

---

## INTRODUCTION

After the pandemic, the 'Train to Dabong' trip has gained nationwide popularity as people seize the opportunity to explore Malaysia's hidden gems (Berita Harian, 2022). Dabong, a charming village in Kelantan, has become renowned for its natural wonders, including waterfalls and caves. However, beneath its scenic beauty lies a significant issue. Dabong struggles with marketing its services and products compared to other ecotourism destinations, making it difficult for tourists to find relevant travel packages online. This is evident from the limited selection of only six packages offered by local tour operators on the Expedia.com website (2022). Additionally, Dabong lacks diverse activities, experiences, and accommodations, which hampers tourist engagement in the area.

**Table 1.1: Number of tourist arrivals at Malaysia's ecotourism destinations (2021)**

Number of tourist arrivals at Malaysia's ecotourism destinations (2021)			
Dabong (Kelantan)	Cameron Highland (Pahang)	Hulu Langat (Selangor)	Kinabalu Park (Sabah)
50 000	790 024	344 027	269 819

Source: Statistic Tourist Arrival in Malaysia (2021)

These limitations are reflected in the number of tourists visiting Dabong (Table 1.1), which is lower compared to other popular ecotourism destinations like Cameron Highlands and Kinabatangan. To address this situation, immediate action is required. Destination Management Organizations (DMOs) or authorities in Dabong must prioritize promoting and expanding the range of engaging activities available to enhance the visitor experience. Such improvements have the potential to increase tourist

arrivals and encourage repeat visits to Dabong. This, in turn, would boost profits and position Dabong as a formidable competitor among ecotourism destinations. Moreover, ecotourism can stimulate economic development, enhance social welfare, and contribute to the preservation of natural environments and cultural heritage through awareness creation (Manu et al., 2012).

To effectively market and promote Dabong's destination qualities, destination managers must highlight the unique aspects of memorable tourism experiences (MTEs) alongside offering such experiences on-site. This involves effectively showcasing various local tourist programs, a diverse range of activities, notable tourism infrastructure, and the warm hospitality of local residents in commercials and promotional materials. Research on MTEs supports the notion that novel experiences are better remembered (Kim, Hallab, et al., 2012; Kim, Ritchie, et al., 2012), and experiencing something new, unique, or different enhances the memory of the travel experience (Kim, 2010; Kim, Hallab, et al., 2012; Kim, Ritchie, et al., 2012). Tung and Ritchie (2011) further emphasize the crucial role of destination managers in facilitating an environment that allows tourists to create their own MTEs.

Despite the significance of MTEs in destination positioning, studies on MTEs in ecotourism destinations remain limited. Currently, research has primarily focused on MTEs in areas such as cultural tourism (Siamak, Michael & S. Mostafa, 2019), urban tourism (Chao et al., 2019), museums (Islam et al., 2020), and heritage destinations (Mostafa et al., 2021). Therefore, this study aims to investigate the impact of MTEs on behavioral intentions in the context of ecotourism destinations in Dabong, Kelantan.

There are four objectives of this research and there are:

1. To examine the relationship between hedonism on behavioral intention.
2. To examine the relationship between novelty seeking on behavioral intention.
3. To examine the relationship between tourist meaningfulness experience on behavioral intention.
4. To examine the relationship between tourist knowledge on behavioral intention.

## **SIGNIFICANT OF STUDY**

### **Practical perspective**

The practical significance of this study lies in its potential to provide valuable insights and practical implications for tour operators and tourism marketers. By examining the influence of memorable ecotourism experiences on tourists' behavioral intentions in Dabong, Kelantan, this research offers practical guidance for creating and promoting impactful eco-tourism experiences. The findings highlight the importance of factors such as hedonism, novelty, meaningfulness, and knowledge in shaping tourists' intentions. Armed with this knowledge, tour operators and tourism marketers can strategically design and market eco-tourism experiences that resonate with visitors, thereby enhancing their satisfaction. Ultimately, the study's practical significance lies in its ability to inform and guide industry professionals in their efforts to create memorable and impactful eco-tourism experiences in Dabong, Kelantan, leading to increased visitor satisfaction and potentially boosting the local tourism industry.

### **Academic perspective**

The academic significance of this study is twofold. Firstly, it contributes to the existing body of knowledge by being the first investigation to specifically explore the influence of memorable ecotourism experiences on behavioral intentions within the context of an ecotourism destination in

Kelantan. By focusing on Dabong, the study expands the understanding of how eco-tourism experiences can impact tourists' intentions and sheds light on the unique dynamics and factors at play in this particular destination. Secondly, this study extends to the broader field of tourism research by investigating the factors that drive tourists' behavioral intentions in the context of eco-tourism experiences, the study adds to the theoretical understanding of tourist behavior and decision-making processes. The findings provide valuable insights into the importance of hedonism, novelty, meaningfulness, and knowledge in shaping tourists' intentions, thereby enriching the existing body of knowledge on tourist motivations and preferences.

## **LITERATURE REVIEW**

### **Hedonism**

Hedonism was described by Kim et al. (2010) as "pleasurable sentiments that stimulate oneself in terms of travel experiences. According to Mannell and Kleiber (1997), hedonism is the pursuit of pleasure. It is an essential component of recreational activities. Hedonism can also be enjoyed while travelling (Xie, 2005). The level of hedonism consumers experience is likely to have an impact on how valuable they believe a product or service to be (Coudounaris & Sthapit, 2017). According to Tung and Ritchie (2011), positive emotions and sensations connected with travel experiences, such as pleasure and enjoyment, were essential to MTE. Kim (2014) also investigated how essential hedonism is to the characteristics of MTE destinations. People seek enjoyment (i.e. pleasure/hedonism) when "consuming" tourist things or experiences, in contrast to other products and activities (Holbrook & Hirschman, 1982).

### **Novelty**

Novelty signifies the property of being new and uncommon, something not experienced before. Novelty seeking is a key driving force behind travel and has been linked to the likelihood that satisfied tourists will not return to the same location. (Kim & Kim, 2015). Since people wish to have an experience that contrasts with their previous experiences, tourists are more likely to choose novel and unusual activities than they would otherwise (Bigné et al, 2009). Numerous research have shown that there is a correlation between the appeal of travel places and travellers' desire for novelty. (Kassean and Gassita, 2013). Additionally, researchers have noted that novelty-seeking has a favourable effect on visitor pleasure (Assaker et al, 2011,.) When an encounter deviates from a visitor's expectations, novel tourism experiences are characterised (Ma et al, 2013).

### **Meaningfulness**

A sense of high value, significance, or an expansion of one's perspective on life and society are all examples of what is meant by meaning (Uriley, 2005). According to earlier studies, the meaningfulness dimension includes thinking about one's significance when travelling or learning about oneself. This dimension is linked to traveler's propensity to look for enriching encounters that contribute to their personal development. Travel is a common experience that many people perceive to be beneficial for themselves discovery (Tung and Ritchie, 2011). Tourists who participate in tourism-related events and buy local goods may discover a chance to gain insight into various viewpoints on relevant issues. These pursuits may enhance one's psychological health and well-being, enabling vacationers to express individuality and discover new locations and cultures (Kim et al., 2012). Meaningfulness can encourage the personal development and transformation of the traveller; when returning home, daily life may be viewed from a new perspective, and the lessons learned may be applied to everyday life (Tarssanen, 2007).

### **Knowledge**

Knowledge (the educational component of the travel experience) is connected to gaining new knowledge and abilities (Kim, 2016; Kim & Ritchie, 2014). This causes travel to important historical

and cultural locations to be significantly motivated by self-education, which enhances knowledge and abilities. Research has shown that visitor happiness benefits plans and returns (Yoon & Uysal, 2005; da Costa Mendes, Oom do Valle, Guerreiro and Silva 2010; Kim et al., 2015; Tapar et al., 2017). Kim, Woo, and Uysal's (2015) research also demonstrated that a high degree of leisure experience satisfaction enhances the chance of a repeat trip. According to studies on tourism motivation, one of the push factors that motivates individuals to travel is the desire to learn. For instance, a lot of individuals travel to learn more about the places they go (especially in terms of geography, history, language, and culture). Discovered that intellectual growth was one of the most important elements of MTEs in a study that tried to understand the "essence" of MIEs Tung and Ritchie (2011).

### **Behavioural Intention**

Swan (1981) defines behavioural intention as an individual's anticipated future behaviour. According to (Baloglu, 2000), it has been linked to observed behaviour. Ajzen (1988, 1991) then introduced the Theory of Planned Behavior to predict behaviours that are not completely under volitional control. According to the Theory of Planned Behavior (Ajzen, 1991), factors such as attitudes toward a location, subjective norms, and perceived behavioural control may impact tourist destination choice and future behavioural intentions. The Theory of Planned Behavior's fundamental propositions is that people are more likely to engage in a specific type of behaviour if they believe it will result in a specific and valuable outcome, that their essential referents will value and approve of the behaviour, and that they have the necessary abilities, resources, and opportunities to engage in such behaviour (Ajzen, 1985; Conner et al., 1999).

### **Research Hypothesis**

The following research hypothesis is based on a conceptual framework; independent variables, namely Hedonism, Novelty, Meaningfulness and Knowledge, were determined and dependent variables, i.e., behavioural intention.

H1: There is a significant relationship between hedonism and behavioural intention.

H2: There is a significant relationship between novelty seeking and behavioural intention.

H3: There is a significant relationship between tourist meaningfulness experience and behavioural intention.

H4: There is a significant relationship between tourist knowledge and behavioural intention.

### **Research Framework**

A study framework has been presented to examine the link to discover the influence of memorable tourist experiences on behavioural intention in Ecotourism. The dependent variable is behavioural intention. The proposed independent variable consist of Hedonism, Novelty, Meaningfulness and Knowledge.

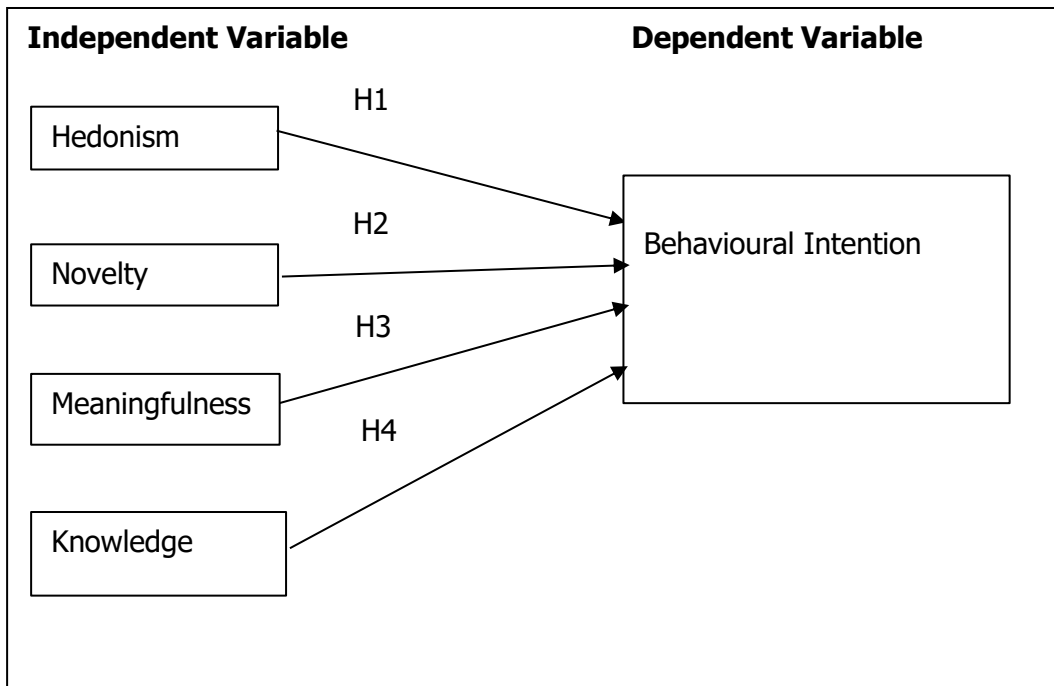

Figure 1: Proposed Conceptual Framework Adapted from Kim and Ritchie (2013)

## METHODOLOGY

The research design is the plan that outlines how the researcher will answer a set of questions and obtain, analyze, and interpret data. In this study, a quantitative research design was employed, using self-administered questionnaires distributed through a Google Form. The data collection period spanned three months, taking advantage of public holidays and busy tourist seasons. Purposive sampling was used to select 384 individuals who partake trip train to Dabong, a popular eco-tourism destination in Kelantan. Data analysis involved using statistical methods, including descriptive statistics, reliability statistics, Pearson's correlation, and regression, using the SPSS software.

## FINDINGS

### Descriptive Analysis

This segment information showed the mean score attained as descriptive analysis. Overall mean score and standard deviation of variables and sub-variables were designed based on 5 points Likert scale (1= strongly disagree, 2= disagree, 3= somewhat disagree, 4= neutral, 5= somewhat agree, 6= agree, and 7= strongly agree). The overall mean (M) and standard deviation (SD) for each variable and measurement are exposed.

The independent variables verified moderate mean score (M= 6.31978, SD= 0.79550). Altogether the dimension variables also scored a moderate mean score where hedonism 6.3645(SD= 0.81758), novelty 6.3202 (SD= 0.83164), meaningfulness 6.2693 (SD= 0.91903) and knowledge 6.3251(SD= 0.86710). Besides, the dependent variable verified middle mean score (M=6.5406, SD=0.72347) where the sub variable named aesthetic gained 6.5406 (SD=0.72347).

### Reliability Test

The reliability analysis was conducted in this analysis to determine Cronbach's Alpha values for all variables. The value follows Hedonism (0.877), Novelty (0.906), Meaningfulness (0.893), Knowledge

(0.894) and Behavioural Intention (0.887). All the reliability was above the 0.86 average, usually considered very good (Matkar, 2012).

### Demographic Profile

There were a total of 203 sets of questionnaires assigned through the online platform. Table 4.2 displays common of the respondents are male with 50.2% (n=102) related to 49.8% (n=101) are female. In table 4.3, respondents who responded to this survey are speciously age between 21 – 30 years old with the frequency of 136 respondents (67.0%). Based on table 4.4, most of the respondents who answered this survey were single, with 127 respondent (62.6%). The table 4.5 showed most of the respondents in the race are Malay, with 140 respondents (69.0%). Table 4.6 showed most of the respondents in the religion are Islam with 149 respondents (73.4%). Additionally, table 4.7 show that most respondents have a degree with 112 respondents (55.2%). Table 4.8 shows that the majority of respondents who went to Dabong was 1st time which is 121 respondents (59.6%). Lastly, based on table 4.9 shows the average length of stay in Dabong. The highest average length of stay in Dabong is less than 3 days with 163 respondents (80.3%).

Table 1: Respondent Demographic profile

Respondent profile	Classification	Frequency N= 203	Percentage (%)
<b>Gender</b>	Male	102	50.2%
	Female	101	49.8%
<b>Age</b>	< 20	18	8.9%
	21-30	136	67.0%
	31-40	42	20.7%
	41 above	7	3.4%
<b>Status</b>	Single	127	62.6%
	Married	76	37.4%
<b>Race</b>	Malay	140	69.0%
	Chinese	36	17.7%
	Indian	23	11.3%
	Other	4	2.0%
<b>Religion</b>	Islam	149	73.4%
	Christian	26	12.8%
	Hindu	15	7.4%
	Buddha	13	6.4%
<b>Education Background</b>	Diploma	33	16.3%
	Degree	112	55.2%
	Master	17	8.4%

	PHD	3	1.5%
	Other	38	18.7%
<b>Frequently visit</b>	1 <sup>st</sup> time	121	59.6%
	2 <sup>nd</sup> time	72	35.5%
	More than 3 times	8	3.9%
	Other	2	1.0%
<b>Length of stay</b>	Less than 3 days	163	80.3%
	3-5 days	37	18.2%
	5-7 days	3	1.5%

### Hypothesis Testing

There are four (4) possibilities were provided. The first hypothesis establishes a favourable association between hedonism and behavioural intention. The second hypothesis establishes a positive link between novelty and behavioural intention. The third hypothesis establishes a positive link between meaningfulness and behavioural intent. Finally, the fourth hypothesis investigates the link between knowledge and behavioural intention.

<b>Hypothesis</b>	<b>Result</b>	<b>Findings of Data Analysis</b>
<b>H1:</b> There is a positive relationship between hedonism and behavioural intention.	$r = 0.713, p = 0.000$ Strongly positive	<b>H1: Accepted</b>
<b>H2:</b> There is a positive relationship novelty and behavioural intention.	$r = 0.598, p = 0.000$ Strongly positive	<b>H2: Accepted</b>
<b>H3:</b> There is a positive relationship between meaningfulness and behavioural intention.	$r = 0.711, p = 0.000$ Strongly positive	<b>H3: Accepted</b>
<b>H4:</b> There is a positive relationship between tourist knowledge and behavioural intention.	$r = 0.670, p = 0.000$ Strongly positive	<b>H4: Accepted</b>

The above table serves to summarise the findings of this study. Hypotheses that have been tested for this study will be further elaborated as follow:



Hypothesis 1 (H1) proposed that hedonism has a very strong positive link with behavioural intention. The education recorded value of Spearman Correlation Coefficient, which is  $r = 0.713$ ,  $p = 0.000$ , according to the findings provided in Table 4.16. As a result, the finding supports hypothesis 1 (H1), which states hedonism is positively associated with behavioural intention.

Hypothesis 2 (H2) proposed that novelty has a very strong positive link with behavioural intention. The education recorded value of Spearman Correlation Coefficient, which is  $r = 0.598$ ,  $p = 0.000$ , according to the findings provided in Table 4.17. As a result, the finding supports hypothesis 2 (H2), which states novelty is positively associated with behavioural intention.

Hypothesis 3 (H3) proposed that meaningfulness has a very strong positive link with behavioural intention. The education recorded value of Spearman Correlation Coefficient, which is  $r = 0.711$ ,  $p = 0.000$ , according to the findings provided in Table 4.18. As a result, the finding supports hypothesis 3 (H3), which states meaningfulness is positively associated with behavioural intention.

Hypothesis 4 (H4) proposed that tourist knowledge has a very strong positive link with behavioural intention. The education recorded value of Spearman Correlation Coefficient, which is  $r = 0.670$ ,  $p = 0.000$ , according to the findings provided in Table 4.19. As a result, the finding supports hypothesis 4 (H4), which states that tourist knowledge is positively associated with behavioural intention.

## **DISCUSSION AND RECOMMENDATION**

The findings of this study demonstrate a positive correlation between hedonism, novelty, meaningfulness, and knowledge with behavioral intention among tourists who have taken train trips to Dabong, Kelantan. These results indicate that tourists who have memorable eco-tourism experiences are more likely to exhibit favorable behavioral intentions, such as revisiting the destination or recommending it to others.

Based on these findings, several recommendations can be made. Firstly, researchers can utilize the eight memorable tourism experience (MTE) factors identified in existing literature to further explore and enhance the understanding of the impact of these factors on behavioral intention. Expanding the study region beyond a single state, such as incorporating multiple ecotourism destinations, would provide a broader perspective and contribute to the generalizability of the findings.

Additionally, there is a need for more methodological research by referencing researchers and organizers. This could involve refining and developing measurement tools or frameworks to better capture the nuances and complexities of memorable eco-tourism experiences and their relationship with behavioral intention. Such research would strengthen the validity and reliability of future studies in this field.

Lastly, it is worth noting that this study primarily employed a quantitative research approach, which provides valuable insights into the relationships between variables but may not capture the full depth and richness of tourists' experiences. Future research could consider incorporating qualitative methods, such as interviews or focus groups, to gain a more comprehensive understanding of the subjective aspects of memorable eco-tourism experiences and their impact on behavioral intention.

In conclusion, this study contributes to the understanding of the impact of memorable eco-tourism experiences on behavioral intention. The positive correlation between hedonism, novelty, meaningfulness, and knowledge highlights the importance of creating and promoting memorable experiences to enhance tourists' intentions. The recommendations for future research and the acknowledgement of limitations provide directions for further exploration and development in this field of study.

## **CONCLUSION**

In conclusion, this study has shed light on the impact of memorable eco-tourism experiences on the behavioral intentions of tourists who have taken train trips to Dabong, Kelantan. The findings reveal a positive correlation between hedonism, novelty, meaningfulness, and knowledge with behavioral intention, indicating that tourists who have memorable experiences are more likely to exhibit favorable intentions such as revisiting the destination and recommending it to others. These findings have significant implications for researchers and practitioners in the field of eco-tourism. Researchers can utilize the identified eight memorable tourism experience (MTE) factors from existing literature to further investigate and enhance our understanding of their impact on behavioral intention. Additionally, broadening the study region beyond a single state and incorporating multiple ecotourism destinations would provide a more comprehensive perspective and enhance the generalizability of the findings. In addition, this study emphasizes the importance of creating and promoting memorable eco-tourism experiences to enhance tourists' behavioral intentions. By considering the identified factors and addressing the research recommendations, practitioners can better cater to tourists' preferences and maximize their satisfaction. Ultimately, this research contributes to the growing body of knowledge in the field of eco-tourism and offers valuable insights for researchers, policymakers, and industry professionals alike.

## REFERENCES

- Akhshik, A., Rezapouraghdam, H., Ozturen, A., & Ramkissoon, H. (2022). Memorable tourism experiences and critical outcomes among nature-based visitors: a fuzzy-set qualitative comparative analysis approach. *Current Issues in Tourism*, 1–23. <https://doi.org/10.1080/13683500.2022.2106196>
- Akter, M., Sadekin, M. N., & Patwary, A. K. (2020). An Empirical Study on Students' Satisfaction from Mawlana Bhashani Science & Technology University, Bangladesh. *Review of Economics and Development Studies*, 6(2), 363-379.
- Alom, S., Patwary, A. K., & Khan, M. M. H. (2019). Factors affecting the turnover intention of Bangladeshi migrants in the United Arab Emirates: An empirical study on the hotel industry. *International Journal of Innovation, Creativity and Change*, 8(3), 344-360.
- Blomstervik, I. H., Prebensen, N. K., Campos, A. R. N., & Pinto, P. (2020). Novelty in tourism experiences: the influence of physical staging and human interaction on behavioural intentions. *Current Issues in Tourism*, 24(20), 2921–2938. <https://doi.org/10.1080/13683500.2020.1854197>
- Elgammal, I., Ferretti, M., Risitano, M., & Sorrentino, A. (2020). Does digital technology improve the visitor experience A comparative study in the museum context. *International Journal of Tourism Policy*, 10(1), 47. <https://doi.org/10.1504/ijtp.2020.107197>
- Fengmin, Z., Baijun, W., Jiangtao, B., Li, L., & Patwary, A. K. (2022). Investigating revisit intention of medical tourists in China through nutritional knowledge, perceived medical quality, and trust in the physiologist: A recommendation on health tourism policy measures. *Frontiers in Public Health*, 10, 893497.
- Fisher, M. J., & Marshall, A. (2009). Understanding descriptive statistics. *Australian Critical Care*, 22(2), 93–97. <https://doi.org/10.1016/j.aucc.2008.11.003>
- Hazbar, A. M. H., Alem Mohammed, A., & Karim, A. K. A. (2019). An Empirical Study of Factors Influencing hotel customers' online booking Intention. *مجلة العلوم التربوية و الدراسات الإنسانية*, (5), 1-17.
- Ismail, M. R. (2021, June 3). Jelajah Air Terjun Jelawang. *Harian Metro*. <https://www.hmetro.com.my/santai/2021/06/713267/jelajah-air-terjun-jelawang>

- Jelawang Waterfall, Gunung Stong, Gunung Baha, Gunung Ayam.* (n.d.). [http://timeoff2outdoors.com/jelawang\\_waterfall.html](http://timeoff2outdoors.com/jelawang_waterfall.html)
- Khairudin, A. R. M., & Rahman, N. a. A. (2020). Evaluating the quality experience of ecotourist in Taman Negara Pahang. *IOP Conference Series*. <https://doi.org/10.1088/1755-1315/447/1/012014>
- Kim, J., Ritchie, J. R. B., & Tung, V. (2010). The Effect of Memorable Experience on Behavioral Intentions in Tourism: A Structural Equation Modeling Approach. *Tourism Analysis*, 15(6), 637–648. <https://doi.org/10.3727/108354210x12904412049776>
- Kim, S., & Kim, H. (2015). Moderating Effects of Tourists' Novelty-Seeking Tendencies on the Relationship Between Satisfaction and Behavioral Intention. *Tourism Analysis*, 20(5), 511–522. <https://doi.org/10.3727/108354215x14411980111415>
- Lani, J. (2021). Reliability Analysis. *Statistics Solutions*. <https://www.statisticssolutions.com/reliability-analysis/>
- Li, L., Ragavan, N. A., Patwary, A. K., & Baijun, W. (2022). Measuring patients' satisfaction toward health tourism in Malaysia through hospital environment, nutritional advice, and perceived value: A study on Chinese exchange students. *Frontiers in public health*, 10, 893439.
- Li, L., Wu, B., & Patwary, A. K. (2022). How marine tourism promote financial development in sustainable economy: new evidences from South Asia and implications to future tourism students. *Environmental Science and Pollution Research*, 29, 1155-1172.
- Li, L., Wu, B., & Patwary, A. K. (2022). The psychosocial factors affecting chinese Outbound Exchange and mobility students' academic performance during COVID-19. *Frontiers in psychology*, 13, 872516.
- Patwary, A. K., Roy, B., Hoque, R., & Khandakar, M. S. A. (2019). Process of developing a community based tourism and identifying its economic and social impacts: An Empirical study on Cox's Bazar, Bangladesh. *Pakistan Journal of Humanities and Social Sciences*, 7(1), 1-13.
- Sthapit, E., Björk, P., Coudounaris, D. N., & Jiménez-Barreto, J. (2022). Memorable Halal Tourism Experience and Its Effects on Place Attachment. *International Journal of Hospitality & Tourism Administration*, 1–27. <https://doi.org/10.1080/15256480.2022.2135666>
- Sthapit, E., Del Chiappa, G., Coudounaris, D. N., & Björk, P. (2019). Tourism experiences, memorability and behavioural intentions: a study of tourists in Sardinia, Italy. *Tourism Review*, 75(3), 533–558. <https://doi.org/10.1108/tr-03-2019-0102>
- Subramaniam, T., Samdin, Z., Ramachandran, S., & Kunasekaran, P. (2019). Memorable ecotourism experiences in Taman Negara, Pahang. *ResearchGate*. [https://www.researchgate.net/publication/333386650\\_Memorable\\_ecotourism\\_experiences\\_in\\_Taman\\_Negara\\_Pahang](https://www.researchgate.net/publication/333386650_Memorable_ecotourism_experiences_in_Taman_Negara_Pahang)
- Sumethokula, P., Patwary, A. K., Srinuanpanc, B., Srinuanpand, C., Suwandeee, P., Thammathikul, A., & Phanong, W. (2020). The potential of new tour repackaging for creative tourism among entrepreneurs in Nakhon Si Thammarat. *International Journal of Innovation, Creativity and Change*, 13(10), 1752-1771.
- User. (2023). *INFO DABONG. Portal Rasmi Majlis Daerah Dabong (MDD)*. Majlis Daerah Dabong. <https://mddabong.kelantan.gov.my/index.php/pelawat/infodabong>
- Wu, B., Liu, S., Wang, J., Tahir, S., & Patwary, A. K. (2021). Assessing the mechanism of energy efficiency and energy poverty alleviation based on environmental regulation policy measures. *Environmental Science and Pollution Research*, 28, 40858-40870.

- Wu, B., Zhai, B., Mu, H., Peng, X., Wang, C., & Patwary, A. K. (2021). Evaluating an economic application of renewable generated hydrogen: A way forward for green economic performance and policy measures. *Environmental Science and Pollution Research*, 1-15.
- Yunus, M. (2021, October 29). Pengalaman Menarik “Train To Dabong” Selepas PKP. *Mawardi Yunus ; Malaysian Travel Blogger*. <https://www.mawardiyunus.com/2021/10/afiyaa-hayyiba.html>
- Yusof, A. (2021, October 8). Penumpang KTMB Tumpat-Dabong meningkat 300 peratus. *HarakahDaily*. <https://harakahdaily.net/index.php/2021/10/08/penumpang-ktmb-tumpat-dabong-meningkat-300-peratus/>
- Zhang, H., Wu, Y., & Buhalis, D. (2018). A model of perceived image, memorable tourism experiences and revisit intention. *Journal of Destination Marketing and Management*, 8, 326–336. <https://doi.org/10.1016/j.jdmm.2017.06.004>

## APENDICES

## Emperical paper

### ORIGINALITY REPORT

<b>19%</b> SIMILARITY INDEX	<b>14%</b> INTERNET SOURCES	<b>9%</b> PUBLICATIONS	<b>12%</b> STUDENT PAPERS
--------------------------------	--------------------------------	---------------------------	------------------------------

### PRIMARY SOURCES

<b>1</b>	<b>myscholar.umk.edu.my</b> Internet Source	<b>5%</b>
<b>2</b>	<b>Submitted to Pusan National University Library</b> Student Paper	<b>4%</b>
<b>3</b>	<b>discol.umk.edu.my</b> Internet Source	<b>4%</b>
<b>4</b>	<b>Submitted to North South University</b> Student Paper	<b>1%</b>
<b>5</b>	<b>moam.info</b> Internet Source	<b>1%</b>
<b>6</b>	<b>hrcak.srce.hr</b> Internet Source	<b>1%</b>
<b>7</b>	<b>Submitted to University of Johannesburg</b> Student Paper	<b>1%</b>
<b>8</b>	<b>Savaş Evren, Emine Şimşek Evren, A. Celil Çakıcı. "Moderating effect of optimum stimulation level on the relationship between satisfaction and revisit intention: the case of</b>	<b>1%</b>

# Impact of Event Experience Towards Satisfaction Among E-Sport Events Participant

*Nur Ain Shafiqah bt Dzulkefli, Nur Aisyah Huwaida bt Mohd Nor, Nur Aisyah Huwaina bt Mohd Nor, Nur Amilya Nasuha bt Amran, Nur Zehan bt Abu Bakar*

*Faculty of Hospitality, Tourism and Wellness, Universiti Malaysia Kelantan*

*Corresponding email: nurzehan.ab@umk.edu.my*

---

## ABSTRACT

This research paper aims to investigate and analyze the impact of event experience on the satisfaction levels of e-sport participants. Specifically, the study focuses on three crucial factors: consumer-to-consumer interactions, effective communication, and online content engagement. Data was gathered from a sample of 259 e-sport participants in Kelantan, and the Statistical Package for the Social Sciences (SPSS) was utilized for data analysis. The results obtained from the data analysis strongly support the proposed research model, reinforcing the significance of consumer-to-consumer interactions, effective communication, and online content engagement in shaping e-sport participants' satisfaction levels. The findings provide meaningful insights into the factors that contribute to participant satisfaction, ultimately informing industry professionals, event organizers, and stakeholders in their efforts to enhance the overall e-sport experience.

**Keywords:** *E-sport, participants, satisfaction, event experience, consumer-to-consumer interactions, effective communication, and online content engagement*

---

## INTRODUCTION

Asia stands as the largest and most significant region in the global e-sports industry, with more than 57% of the \$1.1 billion market share. In 2021, the Asia E-sports market generated \$634.3 million, marking a 16.6% increase compared to the previous year. The region boasts nearly 700 million e-sports fans, with a 13% growth in viewership observed in 2021. League of Legends, PUBG, and Valorant dominate the PC e-sports scene in Asia, while PUBG Mobile/BGMI, Free Fire, and League of Legends: Wild Rift take the lead in mobile e-sports (Niko Partner, 2022).

Malaysia, specifically, is predicted to generate \$5.31 million in e-sports revenue in 2023. The market is expected to grow further, reaching \$8.47 million in sales by 2027, with a compound annual growth rate (CAGR) of 12.37% during that period. (Hong, 2022). The largest segment, Media Rights, is projected to contribute \$1.38 million in 2023 (Statista, 2023). Malaysian e-sports competitors have achieved notable success, amassing a total prize money of \$17,004,876.42 USD from 1,054 competitions. Dota 2 stands out with \$12,757,611.39 in winnings, accounting for 75.02% of all Malaysian players' earnings. Yap "xNova" Jianwei, with \$2,028,185.72 USD in prize money from Dota 2 competitions, holds the title of the highest-paid Malaysian player.

While the e-sports events industry holds significant potential, it also faces obstacles. Apart from the challenges posed by the ongoing COVID-19 pandemic, there are other noteworthy barriers to growth. Declining e-sports investments and the difficulty of hosting large-scale live events hinder the industry's progress. Prolonged market uncertainty, reduced advertising and sponsorship spending, and challenges in securing additional funding from existing sponsors are among the factors impeding e-sports expansion (Foley & Lardner, 2020). These concerns are mirrored in the fluctuating number of active players in Malaysian e-sports, causing worry among players, spectators, and fans (Statista, 2022).

Figure 1.0: Total number of active players in E-sport in Malaysia from 2016-2021



Sources: Statista, 2022

In response to this landscape, event organizers in the e-sports industry should prioritize efforts to enhance the experience of visitors, audiences, and participants. Research on event experiences suggests that novel, special, or distinctive encounters leave a vivid impression on individuals, leading to stronger recollection (Kim, Hallab, et al., 2012; Kim, Ritchie, et al., 2012). Moreover, participant satisfaction plays a crucial role in fostering repeat participation, as it is closely tied to the perceived event experience (Krohn & Backman, 2011). However, the study of event experiences, particularly in the realm of e-sports events, remains limited. (Jupiter Research, 2021). Therefore, this study aims to investigate the impact of event experiences on the satisfaction levels of e-sport participants, filling a crucial gap in the existing research.

### ***Research Objectives***

1. To investigate the relationship between the impact of online consumer-to-consumer interaction and satisfaction among e-games participants.



2. To examine the relationship between the impact of effective communication and satisfaction among e-games participants.
3. To assess the relationship between the impact of online content engagement and satisfaction among e-games participants.

## **SIGNIFICANCE OF THE STUDY**

### **Academic Perspectives**

This study holds academic significance as it adds to the existing knowledge in the field of e-sports research. By investigating the influence of event experience on participant satisfaction, it provides insights into consumer-to-consumer interactions, effective communication, and online content engagement within the e-sports context. (Libai, 2010). This dissertation hopefully will provide a noble benefaction by extending a literature review on the satisfaction of event experience. Furthermore, this study will aid in directing future research advancement, particularly in areas associated with event management, including lecturers and students who are majoring in these subjects and fields. (Brodie, 2013). Additionally, this study will aid researchers in drawing solid conclusions from the outcomes of their theories, hypotheses, and research queries

### **Practical Perspective**

The findings offer practical implications for industry professionals, event organizers, and stakeholders, enabling them to improve the e-sports experience. By understanding the factors that contribute to participant satisfaction, these individuals can make informed decisions and implement strategies to enhance the overall e-sport experience. This study bridges the gap between academia and industry, providing actionable insights that can drive improvements in e-sports event planning, execution, and participant engagement. The findings of this study offer practical implications for enhancing the overall e-sport experience. Understanding the factors that contribute to participant satisfaction enables industry professionals and event organizers to make informed decisions and implement strategies that improve various aspects of e-sports events. By emphasizing the importance of consumer-to-consumer interactions, effective communication, and online content engagement, stakeholders can develop initiatives that foster meaningful engagement and create memorable experiences for participants. (Harris, 2000).

## **LITERATURE REVIEW**

### **ONLINE CONSUMER TO CONSUMER INTERACTION**

Increased customer contact made possible by the emergence of social media has the ability to affect how consumers view businesses (Eigenraam et al., 2018; Brodie et al., 2013). Particularly recent sporting occurrences create a "tremendous buzz" online (McGillivray,



2014). While Johnson and Grier (2013) define it as the active or passive interaction between two or more consumers within a service setting, Algesheimer, Dholakia, and Herrmann (2005, p. 21) define consumer interaction from a community perspective as "the consumer's intrinsic motivation to interact and co-operate with community members." This is especially true in online settings because users have access to a variety of digital tools that make it easier for them to engage with one another (Morgan-Thomas & Veloutsou, 2013).

## **EFFECTIVE COMMUNICATION**

Any organization's marketing strategy must prioritise communicating with customers effectively (Adjei et al., 2010; Grisseman & Stokburger-Sauer, 2012). For businesses, effective communication provides a number of advantages, including lowered risk perceptions and positive overall experience ratings from customers (Klaus, 2013). Additionally, Drennan et al. (2015) contend that effective communication improves brand experience and raises brand awareness because people tend to use new information to build experience and draw conclusions that are more certain and self-relevant (Delgado-Ballester et al., 2012). By suggesting that communication is a two-way conversation between a company and its customers, Vargo and Lusch (2004) revolutionised the way businesses approach communication in service settings. Regular contact and follow-ups between the parties involved in this two-way dialogue are essential.

## **ONLINE CONTENT ENGAGEMENT**

This is the basis for setting engagement apart from other relationship concepts with a similar meaning, such involvement. Because it involves a proactive and interactive relationship with an engagement object (such as an event) and necessitates a person's perceived experiential value (Brodie et al., 2013; Mollen & Wilson, 2010), consumer engagement goes beyond involvement (i.e., a consumer's interest and personal relevance of an event) (Hollebeek et al., 2014; Brodie et al., 2011) experiences with a focal agent/object within a particular service connection. Customers are provided with website customizations and website-based interaction (such videos), which not only create value but also encourage more involvement (Liechty et al., 2001). Customization, interactivity, and website design are just a few of the ways that businesses may control how their customers interact with the internet (Srinivasan). According to Schivinski et al. (2016), these elements frequently encourage customers to engage in a two-way conversation with the company (Anderson, & Ponnnavolu, 2002).

Important components of consumer engagement include the capacity for customers to "redesign" their interactions with a company's website (Eigenraam et al., 2018). In other words, increasing the whole experience requires that customers interact with the online material that a company offers (Calder et al., 2009). Mega-events have not been used to test the literature on internet consumer participation. We contend that a greater understanding of the fundamentals of effective consumer participation in this setting is crucial given the universal attraction of big events in contemporary societies and their potential spectrum of repercussions. In particular, we contend that greater comprehension.

**The relationship between consumer-to-consumer interaction, effective communication and online content engagement towards satisfaction among E-sport event participants.**

The rise of social media has enabled an increased interaction between consumers (Brodie, Ilic, Juric, & Hollebeek, 2013; Eigenraam, Eelen, van Lin, & Verlegh, 2018), which has the potential to influence their perceptions of organisations (Carlson & O’Cass, 2012). Contemporary sport events in particular generate a ‘tremendous buzz’ online (McGillivray, 2014). Algesheimer, Dholakia, and Herrmann (2005) define consumer interaction from a community perspective as “the consumer's intrinsic motivation to interact and co-operate with community members”, while Johnson and Grier (2013) refer to it as the active or passive interaction between two or more consumers within a service setting. This is particularly relevant within online environments, where consumers have access to several digital tools that facilitate their interaction with each other (Morgan-Thomas & Veloutsou, 2013). As a result, we define online consumer-to-consumer interaction as the dialogue between two or more consumers by virtue of online experiences.

Communicating effectively with consumers is a critical aspect of the marketing strategy of any organisation (Adjei et al., 2010; Grisseemann & Stokburger-Sauer, 2012). Effective communication has several benefits for organisations, such as reduced perceptions of risk and consumers’ positive evaluations of overall experience (Klaus, 2013). In addition, Drennan et al. (2015) have argued that effective communication increases brand awareness and enhances brand experience, because people tend to use acquired knowledge to build experience and make inferences that are more self-relevant and certain (see also, Delgado-Ballester, Navarro, & Sicilia, 2012). Vargo and Lusch (2004) transformed the way organisations approach communication in service settings, arguing that communication is a two-way dialogue between an organisation and consumers. This two-way dialogue needs to include regular contact and follow ups between the organisation and its consumers (Brodie et al., 2013;

Grissemann & Stokburger-Sauer, 2012). In line with this view, Liang, Ekinci, Occhiocupo, and Whyatt (2013) highlighted the importance for organisations to respond promptly to the opinions and information requests from their consumers.

This is the basis for distinguishing engagement from other similar relational terms such as involvement. That is, consumer engagement extends beyond involvement (i.e. consumer's interest and personal relevance of an event; Hollebeek, Glynn, & Brodie, 2014), given that it encompasses a proactive and interactive relationship with an engagement object (e.g. event) and requires an individual's perceived experiential value (Brodie et al., 2013; Mollen & Wilson, 2010). Experiences with a focal agent/object within a specific service relationship" (Brodie et al., 2011, p. 258). Web customisations and website-based engagement (e.g. videos) delivered to consumers not only generate value but also promote further engagement (Liechty, Ramaswamy, & Cohen, 2001). Organisations have a variety of ways to manage the web experience of their consumers, including customisation, interactivity and website design (e.g. Srinivasan, Anderson, & Ponnnavolu, 2002), and these features often lead consumers to a two-way interaction with the organisation (Schivinski, Christodoulides, & Dabrowski, 2016). Consumers' ability to customise their interaction with an organisation's website and 'redesign' their experience represents important aspects of consumer engagement (Eigenraam et al., 2018).

## **RESEARCH HYPOTHESIS**

Based on the discussion above, the hypotheses of the study are proposed as below:

H1: There is a significant relationship between the impact of online consumer-to-consumer interaction and satisfaction among e-sport participants.

H2: There is a significant relationship between the impact of effective communication and satisfaction among e-sport participants.

H3: There is a significant relationship between the impact of online content engagement and satisfaction among e-sport participants.

## **CONCEPTUAL FRAMEWORK**

Research Framework proposed for the current study are as below:

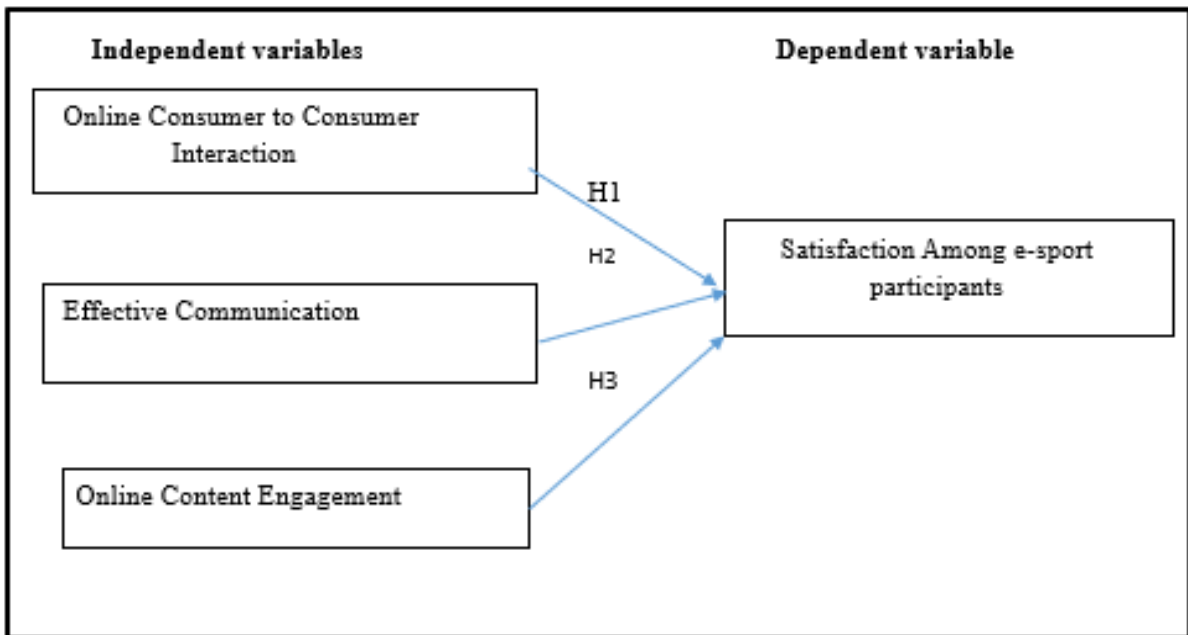

Figure 1: Proposed Conceptual Framework adopted from Husni Kharouf & Rui Biscaia (2020)

## METHODOLOGY

This study adopts a quantitative research design to explore the influence of variables such as online consumer to consumer interaction, effective communication and online content engagement towards satisfaction among e-sport event participants. The target population consists of is the audience or viewers who have participated in any e-sports event is 19.8 million. To ensure an appropriate sample size, the researchers followed **Krejcie & Morgan (1970)** set of guidelines. Data collection is conducted through an online survey utilizing Google Forms, with 259 participants involved. The selection of participants relies on purposive sampling, enabling the researcher to exercise judgment and select individuals with e-sport experience. The research instrument incorporates items drawn from Husni Kharouf & Rui Biscaia (2020) using 5 likert-scale. In order to analyze the gathered data, the researchers employ the Statistical Package for the Social Sciences (SPSS) version 29.0, employing various statistical techniques including descriptive statistics, reliability analysis, Pearson's correlation, and regression.

## FINDINGS

### Demographic Profile

The online platform had originally distributed a total of 384 sets of questionnaire via Google Form, however, only 259 respondents responded; with a response rate of 67.44%. In this section, respondents have a contextual profile. About 62.2% were male and another 37.8% were female. The table indicated majority of the respondents were Malay, with a total of 158 (61%).

Respondents who responded to this survey are mostly aged between 21 to 30 years old, with the frequency of 212 respondents (81.9%). This is followed by those who aged between 31 to 40 years with the frequency of 24 respondents (9.3%). Next, respondents under the age of 20 years old make up a total of 8.1% of respondents with the frequency of 21 and finally, respondents whose aged above 41 years old with total frequency of 2 respondents (0.8%).

According to this table, 64.5% respondents (n=167) have a Bachelor Degree. 46 respondents (17.8%) received a Diploma, followed by 22 respondents (8.5%) with a Form 6 Diploma, 13 respondents (5%) owned a Master Degree; and finally, 4.2% respondents (n=11) graduated with a secondary school diploma. None of the respondents have a PhD yet.

Table 1: Demographic of respondents

<b>Respondent profile</b>	<b>Classification</b>	<b>Frequency</b>	<b>Percentage (%)</b>
		<b>N=259</b>	
<b>Gender</b>	Male	161	62.2%
	Female	98	37.8 %
<b>Age</b>	< 20	21	8.1 %
	21-30 years old	212	81.9%
	31-40 years old	24	9.3%
	41-50 years old	2	0.8%
<b>Race</b>	Malay	158	61%

	Chinese	70	27%
	Indian	26	10%
	Bumiputera	2	0.8%
<b>Marital Status</b>	Married	40	15.4%
	Single	219	84.6%
<b>Respondent's Religion</b>	Islam	160	61.8 %
	Christian	62	23.9%
	Buddha	28	10.8%
	Hindu	4	1.5%
	Sikhism	1	0.4%
	Catholics	1	0.4%
<b>Education</b>	Secondary	11	4.2%
	Form 6	22	8.5 %
	Diploma	46	17.8 %
	Bachelor of Degree	167	64.5 %
	Master of Degree	13	5 %
	PHD	0	0.0%

## Reliability Test

Table 2: Result of Reliability Test

Variable	Number of items	Reliability Cronbach's Alpha	Comment
Online Consumer to Consumer Interaction	3	0.921	Excellent

Effective Communication	3	0.899	Excellent
Online Content Engagement	4	0.900	Excellent
Behavioural Intension	5	0.858	Excellent

The dependability of the computation reveals the instrument's stability and precision in calculating the definition, which contributes to the measure's goodness. Table 2 shows the Cronbach's Alpha Coefficient values for the independent and dependent variables in this study. All variables were ranged between 0.858 to 0.921. This demonstrates that all question presented is reliable and the questionnaire was approved to study the Impact of Event Experience Among E-sports Events Participants.

### Descriptive Analysis

A descriptive analysis is a short descriptive coefficient that summarises a given data set, which can represent the entire population or a subset of the population.

Table 3: Results of Descriptive Analysis.

<b>Variables</b>	<b>N</b>	<b>Mean</b>	<b>Standard Deviation</b>
Online consumer to consumer interaction	259	4.9289	1.17129
Effective Communication	259	4.9457	1.06929
Online content engagement	259	4.9829	1.09160

Table 3 shows the independent variable and dependent variable, the mean score, and the standard deviation analysis. Online consumer-to-consumer interaction, effective communication, and online content engagement were the independent variables while the behavioural intention was the dependent variables. The highest mean value was 4.9829, which is Online Content Engagement. Meanwhile, the lowest mean value was Online Consumer-to-Consumer Interaction, which is only 4.9289.

### Pearson's Correlation

Table 4: Summary result of Spearman Correlation Coefficient

Hypothesis	Result	Findings of Data Analysis
<b>H1:</b> There is a positive relationship between online consumer-to-consumer interaction and e-sports participants' satisfaction.	r = 0.613, p = >0.001  Highly positive	<b>H1: Accepted</b>
<b>H2:</b> There is a positive relationship between effective communication and satisfaction among e-sports participants.	r = 0.609, p = >0.001  Highly positive	<b>H2: Accepted</b>
<b>H3:</b> There is a positive relationship between online content engagement and satisfaction among e-sport participants.	r = 0.649, p = >0.001  Highly positive	<b>H3: Accepted</b>

Table 4 serves to summarise the findings of this study. Based on Table 4, the result revealed that all three variables have a strong relationship with the Satisfaction Among E-sports Event Participants with correlation value range from 0.609 to 0.649. The highest correlation relationship was Online Content Engagement and the lowest one was Effective Communication. Nevertheless, all hypothesis are accepted.

## DISCUSSION AND RECOMMENDATION



The study was conducted to examine the Impact of Event Experience Towards Satisfaction Among E-Sport Events Participants. The researchers recognised that there were several limitations to their study. The first limitation is related to the time taken to collect respondents' responses. To overcome this issue, researchers can aid in filling the questionnaire responses on behalf of the respondents. This is due to the fact that most respondents were too busy with their commitments.

Next, the study conducted only focuses on Malaysia's respondents who had participated in esports events. The questionnaire was conducted through Google Form which was then distributed through WhatsApp, and Instagram. Therefore, we believe that this study is still far from being completed since the data collected were only in Malaysia. Besides, the distribution window for this survey is relatively narrow, as it runs from February through April. Hence, for this second limitation, we recommended future researchers to further expand the study to outside of Malaysia to cover wider regions of respondents such as the Philippines and 89Indonesia. This is because Southeast Asia is quickly emerging as a global hotspot for professional gaming, attracting big-name sponsors to an esports sector that is predicted to nearly treble by mid-decade.

Finally, researchers only use only three variables that could influence satisfaction among esports participants namely: content engagement, effective communication, and online consumer-to-consumer interaction. To overcome this issue, future investigations should explore other factors that may influence esport player happiness, such as complex interplay, game design, performance, competitiveness, community and social ties, and accessibility.

## CONCLUSION

This study aimed to investigate the impact of event experience towards satisfaction among e-sports event participants, including factors such as online consumer-to-consumer interaction, effective communication, and online content engagement. The findings revealed a strong association between these objectives and the satisfaction among E-sports events participants. The respondents acknowledged the significant impact that Online Consumer-to-Consumer Interaction, Effective Communication, and Online Content Engagement and their overall satisfaction in E-sports Events as participants. This study has the potential as a guideline to future researchers or event organisers in ensuring that the event participants satisfaction is always be taken as a top priority, hence contributing to the overall success of event organising; especially in E-sports.

## REFERENCES

- Akter, M., Sadekin, M. N., & Patwary, A. K. (2020). An Empirical Study on Students' Satisfaction from Mawlana Bhashani Science & Technology University, Bangladesh. *Review of Economics and Development Studies*, 6(2), 363-379.
- Alom, S., Patwary, A. K., & Khan, M. M. H. (2019). Factors affecting the turnover intention of Bangladeshi migrants in the United Arab Emirates: An empirical study on the hotel industry. *International Journal of Innovation, Creativity and Change*, 8(3), 344-360.
- Aspers, P., & Corte, U. (2019, February 27). What is Qualitative in Qualitative Research. *Qualitative Sociology*, 42(2), 139 - 160. <https://link.springer.com/article/10.1007/s11133-019-9413-7>
- Cooley, D. A., Bloodwell, R. D., Beall, A. C., Jr, Gill, S. s., & Hallman, G. L. (1966, September). Total cardiac valve replacement using SCDK-cutter prosthesis: experience with 250 consecutive patients. *Annals of Surgery*, 164(3), 428. <https://doi.org/10.1097/00000658-196609000-00006>
- Fengmin, Z., Baijun, W., Jiangtao, B., Li, L., & Patwary, A. K. (2022). Investigating revisit intention of medical tourists in China through nutritional knowledge, perceived medical quality, and trust in the physiologist: A recommendation on health tourism policy measures. *Frontiers in Public Health*, 10, 893497.
- Hazbar, A. M. H., Alem Mohammed, A., & Karim, A. K. A. (2019). An Empirical Study of Factors Influencing hotel customers' online booking Intention. *مجلة العلوم التربوية و الدراسات الإنسانية*, 5(5), 1-17.
- Hong, H. J. (2022, January 28). eSports: the need for a structured support system for players. *European Sport Management Quarterly*, 25(5). <https://doi.org/10.1080/16184742.2022.2028876>
- Jae, K. M., & Seong, K. M. (n.d.). Spectator e-sport and well-being through live streaming services. *Technology in Society*, 63(1). <https://doi.org/10.1016/j.techsoc.2020.101401>
- Jin, H. Y., Jae, K. Y., & Valacich, J. S. (2011, September). A Structural Model of the Relationships Between Sport Website Quality, E-Satisfaction, and E-Loyalty. *Journal of Sport Management*, 25(5), 485 - 473. <https://doi.org/10.1123/jsm.25.5.458>
- Kharouf, H., Biscaia, R., Perez, A. G., & Hickman, E. (2020, December). Understanding online event experience: The importance of communication, engagement and interaction. *Journal of Business Research*, 121, 735 - 746. <https://doi.org/10.1016/j.jbusres.2019.12.037>
- Li, L., Ragavan, N. A., Patwary, A. K., & Baijun, W. (2022). Measuring patients' satisfaction toward health tourism in Malaysia through hospital environment, nutritional advice, and perceived value: A study on Chinese exchange students. *Frontiers in public health*, 10, 893439.
- Li, L., Wu, B., & Patwary, A. K. (2022). How marine tourism promote financial development in sustainable economy: new evidences from South Asia and implications to future tourism students. *Environmental Science and Pollution Research*, 29, 1155-1172.
- Li, L., Wu, B., & Patwary, A. K. (2022). The psychosocial factors affecting chinese Outbound Exchange and mobility students' academic performance during COVID-19. *Frontiers in psychology*, 13, 872516.
- Liechty, J., Ramaswamy, V., & Cohen, S. H. (2001, May). Choice Menus for Mass Customization: An Experimental Approach for Analyzing Customer Demand with an Application to a Web-Based Information Service. *Journal of Marketing Research*, 38(2), 183 - 196. <https://doi.org/10.1509/jmkr.38.2.183.18849>
- Ngee, L. C., Nee, G. Y., Isa, S. M., Thurasamy, R., & Suki, N. M. (2022, October 16). A Bibliometric Review on Esports Participation: View from Malaysia. *Journal of Entrepreneurship , Business and Economics*, 10(2), 139 - 171. <https://scientificia.com/index.php/JEBE/article/view/184>

- Patwary, A. K., Roy, B., Hoque, R., & Khandakar, M. S. A. (2019). Process of developing a community based tourism and identifying its economic and social impacts: An Empirical study on Cox's Bazar, Bangladesh. *Pakistan Journal of Humanities and Social Sciences*, 7(1), 1-13.
- Qian, T. Y., Wang, J. J., Hulland, J., & Zhang, J. J. (2022). Fulfilling the Basic Psychological Needs of Esports Fans: A Self-Determination Theory Approach. *Communication & Sport*, 10(2), 216 - 240. <https://doi.org/10.1177/2167479520943875>
- Schivinski, B., Christodoulides, G., & Dabrowski, D. (2016, February). Measuring Consumers' Engagement With Brand-Related Social-Media Content: Development and Validation of a Scale that Identifies Levels of Social-Media Engagement with Brands. *Journal of Advertising Research*, 56(1), 64 - 80. <https://doi.org/10.2501/JAR-2016-004>
- Sumethokula, P., Patwary, A. K., Srinuanpanc, B., Srinuanpand, C., Suwandee, P., Thammathikul, A., & Phanong, W. (2020). The potential of new tour repackaging for creative tourism among entrepreneurs in Nakhon Si Thammarat. *International Journal of Innovation, Creativity and Change*, 13(10), 1752-1771.
- Tian, C. Y., Bek, Drren, Lee, Wan Rui, Loh, How Zheng, Tiong, & Ing Teck. (2021, January 7). *The motivational factors that affect online gaming community to participate esports in Malaysia*. UTAR. <http://eprints.utar.edu.my/3873/>
- Wu, B., Liu, S., Wang, J., Tahir, S., & Patwary, A. K. (2021). Assessing the mechanism of energy efficiency and energy poverty alleviation based on environmental regulation policy measures. *Environmental Science and Pollution Research*, 28, 40858-40870.
- Wu, B., Zhai, B., Mu, H., Peng, X., Wang, C., & Patwary, A. K. (2021). Evaluating an economic application of renewable generated hydrogen: A way forward for green economic performance and policy measures. *Environmental Science and Pollution Research*, 1-15.

# INVESTIGATION OF BUNDLE EVENT AND VISITOR SATISFACTION

## A CASE OF BUNDLE EVENT

NUR AMNI ATHIRAH BINTI JASURA, NUR ANIS SHAHIRAH BINTI OTHMAN, NUR AQILAH BINTI TJUMAN, NUR ASSYUARA, NURZEHAN BINTI ABU BAKAR

*Faculty of Hospitality, Tourism and Wellness, Universiti Malaysia Kelantan*

---

### ABSTRACT

This study aims to explore the comprehensive impact of visitors' event experiences through the lens of Pine and Gilmore's (1998) experience economy realm, encompassing entertainment, educational, esthetic, and escapist dimensions. In order to achieve this, 234 questionnaires were distributed to attendees of the Mek Awe bundle event in Kelantan. The collected data was then meticulously analyzed using the Statistical Packages for the Social Sciences (SPSS). The findings from the analysis revealed a significant positive correlation between visitor satisfaction and the elements of entertainment, educational, esthetic, and escapist experiences. This study holds great significance for event organizers as it provides valuable insights into evaluating the success of their events, devising novel experiential programs, and placing a greater emphasis on the personal experiences of event attendees.

---

**Keywords: Pine and Gilmore's; Event experience; Bundle event, Satisfaction**

---

### INTRODUCTION

Established on October 27th, 2022, Mek Awe Market in Dataran Mara, Kota Bharu, Kelantan is managed by Puan Anis, the owner of Rumah Bundle Store. Inspired by her participation in various bundle events across Malaysia, Puan Anis created Mek Awe Market to attract bundle shirt enthusiasts. Through strategic use of social media platforms like TikTok and Instagram, the market quickly gained visibility and offers a diverse range of items, including bundle shirts from Indonesia, Cambodia, Thailand, Vietnam, and the Philippines. These shirts, neatly packed in sacks, provide affordable access to renowned

foreign brands, cultural styles, and fashionable garments, with some items even receiving appraisals and higher price tags (Adam Hayes, 2022)

While Pasar Mek Awe and other bundle events have their unique appeal, they also face challenges such as uninteresting themes, confusion among attendees, and inadequate facilities. Moreover, the inconsistent supply of quality merchandise due to reliance on donated or second-hand items introduces fluctuations in availability and quality (Nguyen et al. 2019) Additionally, bundle events encounter difficulties in promoting themselves and attracting a diverse audience, often being perceived as limited to specific demographics or lacking mainstream appeal.

To overcome these obstacles, event organizers must adopt a comprehensive promotional strategy for Pasar Mek Awe, actively encouraging attendees to share their experiences through customized social media filters. By curating user-generated content on social walls and digital displays, the overall event experience can be enhanced, leading to increased visitor engagement (Daniella Turcanu, 2021). It is crucial to focus on improving event management skills, attracting repeat exhibitors, and delivering a unique and memorable experience to visitors, thus enabling Pasar Mek Awe to overcome its challenges and flourish (Cvent,2021)

Despite these hurdles, the continued support from visitors demonstrates the special place Pasar Mek Awe holds in their hearts. The market offers an exclusive experience to attendees. However, research on event experiences in the context of bundle events remains limited, with most studies focusing on hotel events, general events, and mega bundles (Getz, 2007). Consequently, this study aims to delve into the event experience and visitor satisfaction specifically within the realm of Pasar Mek Awe, filling a crucial research gap in the field. There are four objectives of this research:

1. To examine relationship between escapism experience in bundle events towards visitorsatisfaction

2. To examine relationship between aesthetic experience in bundle events towards visitorsatisfaction
3. To examine the relationship between entertainment experience in bundle events towardsvisitor satisfaction.
4. To examine the relationship between education experience in bundle events towards visitor satisfaction.

## **SIGNIFICANT OF THE STUDY**

### **Academic perspective**

This study holds academic significance in several ways. Firstly, it helps us better understand the experience economy by applying Pine and Gillmore's framework to bundle events, giving us insights into how different aspects of the event experience impact visitor satisfaction. Secondly, it fills a gap in our knowledge by focusing specifically on the Mek Awe bundle event, allowing us to gain a deeper understanding of what makes visitors happy in this particular context. Thirdly, the study's use of questionnaires and statistical analysis provides a solid foundation for future research methods. Lastly, the findings have practical implications for event organizers, helping them evaluate their events and create more tailored and engaging experiences for attendees. Overall, this study enriches our knowledge, addresses specific questions, contributes to research methods, and offers practical guidance for event organizers.

### **Practical Perspective**

The practical significance of this study lies in its potential to benefit event organizers and enhance the overall success of events. By examining the impact of entertainment, educational, esthetic, and escapist experiences on visitor satisfaction, the study provides valuable insights that can be applied in real-world scenarios. Event organizers can use this knowledge to evaluate their events and make improvements that cater to the preferences and expectations of attendees, ultimately creating more enjoyable experiences. The findings also underscore the importance of creating engaging and meaningful experiences for event participants, which can lead to higher levels of satisfaction and even attract more visitors in the future. In essence, this study offers practical guidance that can empower

event organizers to design and implement truly memorable and impactful events that leave a lasting impression on attendees.

## **LITERATURE REVIEW**

### **Escapism Experience**

Psychological dependence on solely imagined activity or amusement as an escape from reality or habit (Anon, 2019). Escapism in the form of self-suppression is motivated by the desire to avoid painful ideas, self-perceptions, and feelings, while self-expansion is motivated by the desire to obtain good experiences and discover new sides of oneself (Anon, 2022). Often, escape tendencies are a sign of procrastination, although they are not identical.

### **Entertainment Experience**

A number of studies have shown that entertainment is an important determinant of visitors' satisfaction attraction across various contexts, including the influence of physical environment on emotion (Ali & Amin, 2014). Entertainment is activities that are distracting, enjoyable, or fun and appropriate for the time and attention of the audience (Vogel, 2014). Based on Pine and Gilmore's theory, entertainment experience happens when people are passively observing other people's activities or performances through the senses as it portrayed pleasure and enjoyment such as concerts and theatre performances (Radder & Han, 2015). Nostalgia is described as a fondness for goods that were more common when the individual was younger, or a wish to dwell in a bygone era of history (Cervellon et al., 2012).

### **Esthetic Experience**

According to Cupchik and Winston (1996), aesthetic experience is a psychological process in which the attention is focused on the object while all other objects, events, and everyday concerns are suppressed. Aesthetic things are objects that are appreciated for their beauty. These include art, architecture, design, crafts and other elements of human creative expression. Aesthetics are cultural and personal such that what is appealing to one person may not be to another (John Spacey, 2022).

### **Education Experiences**

Experiences are "events that engage the individual in a personal way," according to Pine and Gilmore (1999). An experience "arises in a relation or in a dialectical link between subject and object, both of which will have an influence on what is experienced," according to a Danish report (ODA, 2006:30). Education is often identified as a motivator to use the products and services of visitors who purchase, including tourist attractions. Forhan (2020) mentions that to achieve the event's goals, careful advance planning and strong leadership are still needed for success. Here shows the experience in education is very important in creating a good experience in bundle events and visitor satisfaction.

### **Research Hypothesis**

From the conceptual study in Figure 1 below, the independent variable education, entertainment, aesthetics, and escapism was determined and one dependent variable, namely satisfaction as a mediator for this study, based on the variable cited above, these hypotheses are defining:

H1: Escapism experience positively affects visitor's satisfaction attraction in bundle event.

H2: Aesthetic experience positively affects visitor's satisfaction attraction in bundle event.

H3; Entertainment experience positively affects visitor's satisfaction attraction in bundle event.

H4: Expectations positively affect confirmation attraction in bundle event.

### **Research Framework**

A study framework was established based on the literature evaluation to explore the link between visitor's satisfaction and the investigation of bundle event experience. Figure 2.1 depicts the suggested conceptual framework, which includes the independent variables of escapism, esthetics, entertainment, and education. The dependent variable is visitor's satisfaction.



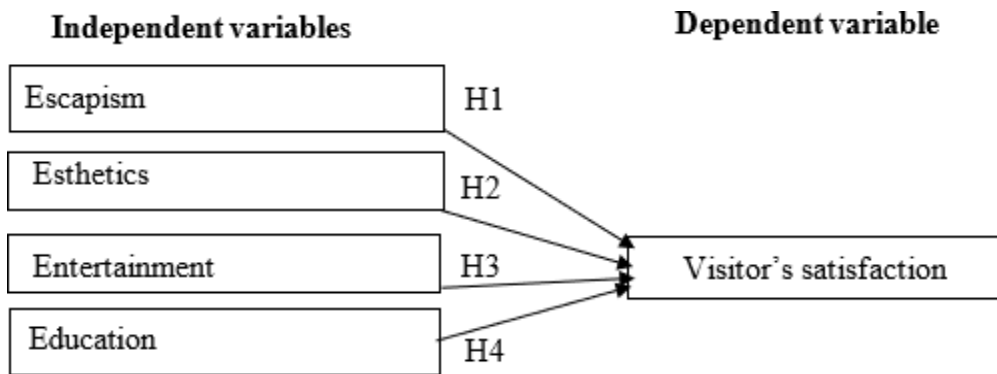

Figure 2.1: Proposed Conceptual Framework adopted from Boo & Busser (2018)

## METHODOLOGY

The study employs a quantitative research design to investigate the impact of variables such as escapism, esthetics, entertainment, and education on visitor satisfaction. The population consists of visitors who have visited Mek Awe bundle event, with a target population 600 visitors weekly. The sample size was determined using a table based on Roscoe's (1975) guidelines. Data collection is conducted through an online survey created using Google Forms, with a total of 234 participants. Purposive sampling is employed, selecting respondents based on the researcher's judgment and expertise. The research instrument consists of items adapted from previous studies in the field of tourism consumer behavior adopted from Boo & Busser (2018). Data analysis involves using the Statistical Package for the Social Sciences (SPSS) version 29.0, utilizing descriptive statistics, reliability analysis, Pearson's correlation, and regression to analyze the collected data.

## FINDINGS

### Descriptive Analysis

According to Will Kenton (2019), the descriptive statistic is a short descriptive coefficient that summarizes a given data set, which can represent a population or a sample population. As a result of descriptive analysis, the segment research explains the mean score obtained. Overall mean score and standard deviation of variables and sub-variables were designed based on 7 points likert scale (1 =

strongly disagree, 2 = disagree, 3 = moderately disagree, 4 = neutral, 5 = moderately agree, 6 = agree, 7 = strongly agree). The overall mean (M) and standard deviation (SD) for each variable and measurement are shown in the table below.

According to the research, it showed that independent variables verified a moderate mean score (M=5.2938, SD=0.96642). Altogether the dimension variables also scored a moderate mean score where escapism M=5.2938, (SD=0.96642), aesthetics M=5.5395, (SD=0.95552), entertainment M=5.7201, (SD=0.97730). Besides, the dependent variable verified middle mean score (M=5.8034, SD=0.98068) where the sub variable named a education.

### **Reliability Test**

The test's reliability denotes how non-biased (error-free) it is and thus guarantees accuracy in calculation over time and across different sections of the instrument (Kumar, 2013). The reliability analysis was conducted in this analysis to determine Cronbach's Alpha values for all variables. The values are as follows: escapism (0.728), aesthetic (0.850), entertainment (0.840), education (0.862) and visitor satisfaction (0.825). All the reliability was above the 0.86 average, usually considered very good (Matkar, 2012).

### **Demographic Profile**

The online platform had assigned a total of 234 sets of questionnaires. Table 1 shows the summarized demographic results of the respondent's profile. About (26.9%) of the respondent were male, and another (73.1%) were female. According to the data, Malay respondents had the greatest value of 197 respondents, or (84.2%) percent, while Chinese had the second highest value of 11 respondents (4.7%). While Indian had the third highest number with a total 6 respondents (2.6%), While Siamese had the fourth highest number with a total 5 respondent (2.1%) and also Dusun 4 respondent (1.7%). The lowest with only 3 respondent (1.3%) which is Bumiputera Sabah and Sarawak. While Bajau had the second lowest value of 2 respondents (0.9%). While Negro had the third lowest which is 1 respondent (0.4%).

Based on the above data, it can be concluded that Muslim respondents have recorded the highest number, with a respondent value of 209 people, or equivalent to 89.3%. while Hindu and Buddha has 6 and 7 respondents recorded the lowest number, with only respondents (2.6%) and Buddha respondent (3.0%). In addition, this data has also shown that Christian respondents recorded the second-highest value with 12 respondents (5.1%).

According to the data acquired using a Google Form survey for the Marital Status area, singles have the biggest number with 182 respondents, corresponding to (77.8%) , while married have 52, ( 22.2%) respondent respectively.

Based on table 1, it shows the average age for the group 21 years old to 30 years old recorded the highest number of respondents with a record of 146 people (62.4%). 31 years old to 40 years old was ranked second with 41 respondents or (17.5%) followed by the age group below 20 with 38 people (16.2%). While 41 years old to 50 years old was in fourth place with 6 respondents or with a percentage value of (2.6%). and the lowest was 51 and above with only 3 respondents (1.3%).

The findings of table 1 show that the majority of respondents in this study have a degree, with a total of 101 people, or 43.2%. In addition, SPM recorded the second-highest value with 45 respondents (19.2%), followed by diploma in third place with 35 respondents, leading to a value of 15.8%, while SPM recorded the fourth-highest value with a reading of 24 respondents 10.3%, While Master recorded the fifth-highest value with 6 respondent and 2.6%. PHD the lowest position with only 4 respondents, or equivalent to 1.7%. The second - lowest position with only 2 respondents (0.9%).

Based on table 1, it shows the average monthly income for the group Below RM 1000 recorded the highest number of respondents with a record of 126 people (53.8%). RM1001- RM2000 was ranked second with 49 respondents or (20.9%), followed by the income group of RM2001-RM3000 with 35 people (15%), while RM3001-RM4000 was in fourth place with 20 respondents or with a percentage value of (8.5%), and the lowest was RM4001 and above with only 4 respondents (1.7%).

Table 1: Respondent Demographics profile

<b>Respondent profile</b>	<b>Classification</b>	<b>Frequency</b>	<b>Percentage (%)</b>
<b>N=234</b>			

<b>Gender</b>	Male	63	26.9%
	Female	171	73.1%
<b>Age</b>	Less than 20 years old	38	16.2%
	21-30 years old	146	62.4%
	31-40 years old	41	17.5%
	41-50 years old	6	2.6%
	51 years old and above	3	1.3%
<b>Race</b>	Malay	197	84.2%
	Chinese	11	4.7%
	Indian	6	2.6%
	Buddha	1	0.4%
	British	1	0.4%
	Siamese	5	2.1%
	Bumiputera Sabah	3	1.3%
	Bumiputera Sarawak	3	1.3%
	Dusun	4	1.7%
	Bajau	2	0.9%
	Negro	1	0.4%
<b>Marital Status</b>	Single	182	77.8%
	Married	52	22.2%
<b>Respondent's Religion</b>	Islam	209	89.3%
	Christian	12	5.1%

	Hindu	6	2.6%
	Buddhist	7	3.0%
<b>Education</b>	SPM	45	19.2%
	Diploma	37	15.8%
	Bachelor of Degree	101	43.2%
	Postgraduates	15	6.4%
	Master of Degree	6	2.6%
	PHD	4	1.7%
	STPM	24	10.3%
	Malaysian Skills Certificate 3	2	0.9%
<b>Income (RM)</b>	Less than RM1000	126	53.8%
	RM1001-RM2000	49	20.9%
	RM2001-RM3000	35	15%
	RM3001-RM4000	20	8.5%
	RM4001 and above	4	1.7%

### Hypothesis Testing

There are four (4) possibilities were provided. The first hypothesis establishes an escapism experiences between visitor's satisfaction attraction in bundle event. The second hypothesis establishes aesthetic experiences link between visitor's satisfaction attraction in bundle event. The third hypothesis establishes entertainment experiences link between visitor's satisfaction attraction in bundle event. Finally, the fourth hypothesis investigates the link between education experience and visitor's satisfaction attraction in bundle event.

Table 2: Hypothesis Testing

Hypothesis	Result	Findings of Data Analysis
<b>H1:</b> Escapism experience positively affects visitor's satisfaction attraction in bundle event.	r = 0.512, p = 0.00 Positive	<b>H1: Accepted</b>
<b>H2:</b> Aesthetic experience positively affects visitor's satisfaction attraction in bundle event.	r = 0.616, p = 0.00 Positive	<b>H2: Accepted</b>
<b>H3:</b> Entertainment experience positively affects visitor's satisfaction attraction in bundle event.	r = 0.610, p = 0.00 Positive	<b>H3: Accepted</b>
<b>H4:</b> Education experience positively affects visitor's satisfaction attraction in bundle event.	r = 0.612, p = 0.00 Positive	<b>H4: Accepted</b>

The above table serves to summarise the findings of this study. Hypotheses that have been tested for this study will be further elaborated as follow:

The first hypothesis (H1) claimed that escapism experience has a positive correlation with visitor's satisfaction attraction in bundle event. The escapism recorded value of Spearman Correlation Coefficient, which is  $r = 0.512$ ,  $p = 0.00$ , according to the findings provided in Table 2. As a result, the finding supports hypothesis 1 (H1), which states that escapism experiences positively affect related to visitor's satisfaction attraction.

Hypothesis 2 (H2) also argued that aesthetics has a positive association towards visitor's satisfaction attraction in bundle event. The aesthetics recorded a Spearman Correlation Coefficient of  $r = 0.616$ ,  $p = 0.00$ , according to the findings provided in Table 2. As a result, the data supports hypothesis 2 (H2), which states that aesthetic experience positively affects visitor's satisfaction attraction in bundle event.

As for entertainment, according to Hypothesis 3 (H3), has a positive association with visitor's satisfaction attraction in bundle event. The data revealed that entertainment is documented in the Spearman Correlation Coefficient,  $r = 0.610$ ,  $p = 0.00$ , as shown in table 2. As a result, the data supports hypothesis 3 (H3), which states that entertainment is positively related to visitor's satisfaction attraction in bundle event.

Education, according to Hypothesis 4 (H4), has a positive link with satisfaction attraction. The findings revealed that education is recorded in Spearman Correlation Coefficient,  $r = 0.612$ ,  $p = 0.00$ , as shown in table 2. As a result, the finding supports hypothesis 4 (H4), which states that education is positively related to visitor's satisfaction attraction in bundle event.

## **DISCUSSION AND RECOMMENDATION**

This study was conducted to investigate the bundle event experience and visitor satisfaction. Result revealed that there is a positive relationship between escapism, aesthetics, entertainment and education towards Mek Awe Bundle Event. The study also revealed that aesthetic variable has more significant relationship with visitor satisfaction. The result indicated that all visitor satisfied visiting Mek Awe Bundle Event. They felt bundle event's venue provide pleasure to their senses, allow them to felt excited to be in the bundle event and learned a lot from the event particularly on how to 'selam bundle'.

This study focus on Mek Awe Bundle Event only. Future researchers can expand the study area from one state to another state around Malaysia or cover different region of Kelantan who have die-hard bundle fans to get a higher number of respondents based on the bundle event. By studying multiple states or regions, researchers can conduct comparative analyses. They can compare different variables, factors, or phenomena across various areas to identify similarities, or trends. This comparative approach can provide valuable insights towards the current study.

A whole amount of 353 questionnaires was distributed online. From 353 questionnaires collected from the targeted respondents, only 234 refunded questionnaires that were useable. The response rate can be considered quite low, hence future researcher should increase number of participants to increases the generalizability of the findings.

Finally, the current researc used only for variables such as escapism, aesthetics, entertainment and education. Future researchers need to include other possibles variables affecting the satisfaction of visitors coming to Mak Awe Pasar bundle such as product variety quality, pricing and value for money. Including these additional variables in future research can provide a more comprehensive

understanding of visitor satisfaction at Mak Awe Pasar Bundle and help identify areas for improvement or enhancement.



## CONCLUSION

The link between four independent factors escapism, aesthetics, entertainment, and education, and the dependent variable, visitor's satisfaction attraction in bundle event, was investigated using a framework Pine and Gilmore Experience Economic Theory Realms (1980). The results show the extent to which the independent variable impacts the dependent variable.

The overall objectives of this research have been answered, and a responsible synthesis of knowledge has been provided. Almost all respondents stated that their visit to Bundle event provided them with an unforgettable visitor experience based on escapism, aesthetics, entertainment, and education. They were excited to have had the opportunity to visit Bundle event at Dataran Mara Kota Bharu Kelantan and hope can come again in event bundle. They also agreed that going to Bundle event, can learn about how to 'Selam Bundle' properly. 'Selam Bundle' can be an attraction for tourists to come bundle event and experience 'Selam Bundle' at the bundle event.

The findings of this study are believed to provide a great help to the bundle club creates attractive activities and teach how to 'Selam Bundle' for entertaining visitors at bundle event. and enticing them to visit bundle event in the future research.

## REFERENCES

- Akter, M., Sadekin, M. N., & Patwary, A. K. (2020). An Empirical Study on Students' Satisfaction from Mawlana Bhashani Science & Technology University, Bangladesh. *Review of Economics and Development Studies*, 6(2), 363-379.
- Al Mahmud, S. R. (2020). The effectiveness of Facebook advertisements on purchase intention of customers in Malaysia. *South Asian Journal of Social Sciences and Humanities*, 1(1), 97-104.
- Ali, F., Ryu, K., & Hussain, K. (2016). Influence of Experiences on Memories, Satisfaction and Behavioral Intentions: A Study of Creative Tourism. *Journal of Travel & Tourism Marketing*, 33(1), 85–100. <https://doi.org/10.1080/10548408.2015.1038418>
- Alom, S., Patwary, A. K., & Khan, M. M. H. (2019). Factors affecting the turnover intention of Bangladeshi migrants in the United Arab Emirates: An empirical study on the hotel industry. *International Journal of Innovation, Creativity and Change*, 8(3), 344-360.
- Apter M J, 1984 "Reversal theory cognitive synergy and the arts" Cognitive processes in the perception of art (North-Holland: Elsevier) *Journal of ap i-Perception* (2012) volume 3, pages 1 – 2. <https://journals.sagepub.com/doi/pdf/10.1068/i0450aap>
- Ayob, N., Wahid, N. A., & Omar, A. (2013). Mediating effect of visitors' event experiences in relation to event features and post-consumption behaviours. *Journal of Convention & Event Tourism*, 14(3), 177–192. <https://doi.org/10.1080/15470148.2013.814037>
- Brian Garrod 1, & David Dowell 2: Experiential Marketing of an Underground Tourist Attraction. School of Management, Swansea University, Bay Campus, Swansea SA1 8EN, UK [https://www.researchgate.net/publication/343566633\\_Experiential\\_Marketing\\_of\\_an\\_Underground\\_Tourist\\_Attraction](https://www.researchgate.net/publication/343566633_Experiential_Marketing_of_an_Underground_Tourist_Attraction)
- Every Business is a stage. HBS. [https://books.google.com.my/books/about/The\\_Experience\\_Economy.html?id=5hs-tyRrSXMC&redir\\_esc=y](https://books.google.com.my/books/about/The_Experience_Economy.html?id=5hs-tyRrSXMC&redir_esc=y)
- Fengmin, Z., Baijun, W., Jiangtao, B., Li, L., & Patwary, A. K. (2022). Investigating revisit intention of medical tourists in China through nutritional knowledge, perceived medical quality, and trust in the physiologist: A recommendation on health tourism policy measures. *Frontiers in Public Health*, 10, 893497.
- Getz, D. (1991). *Festivals, special events, and tourism*. New York, NY: Van Nostrand
- Getz, D. (1997). *Event Management and Event Tourism*. New York: Cognizant Communication. <https://doi.org/10.1016/j.tourman.2006.04.011>
- Hazbar, A. M. H., Alem Mohammed, A., & Karim, A. K. A. (2019). An Empirical Study of Factors Influencing hotel customers' online booking Intention. *مجلة العلوم التربوية و الدراسات الإنسانية*, (5), 1-17. <https://doi.org/10.1080/19368620802590126>  
<https://hbr.org/1998/07/welcome-to-the-experience-economy>
- Jones, Scott (2018). "Mapping the extended frontiers of escapism: binge-watching and hyperdiegetic exploration". *Journal of Marketing Management*. 34:5-6 (5–6): 497–508. Retrieve from <https://www.tandfonline.com/doi/full/10.1080/0267257X.2018.1477818>

- Li, L., Ragavan, N. A., Patwary, A. K., & Baijun, W. (2022). Measuring patients' satisfaction toward health tourism in Malaysia through hospital environment, nutritional advice, and perceived value: A study on Chinese exchange students. *Frontiers in public health*, 10, 893439.
- Li, L., Wu, B., & Patwary, A. K. (2022). How marine tourism promote financial development in sustainable economy: new evidences from South Asia and implications to future tourism students. *Environmental Science and Pollution Research*, 29, 1155-1172.
- Li, L., Wu, B., & Patwary, A. K. (2022). The psychosocial factors affecting chinese Outbound Exchange and mobility students' academic performance during COVID-19. *Frontiers in psychology*, 13, 872516.
- Manthiou, A., Lee, S., Tang, L., & Chiang, L. (2014). The experience economy approach to festival marketing: Vivid memory and attendee loyalty. *Journal of Services Marketing*, 28(2), 22-35.  
[https://www.researchgate.net/publication/277681499\\_The\\_Experience\\_Economy\\_Approach\\_to\\_Festival\\_Marketing\\_Vivid\\_Memory\\_and\\_Attendee\\_Loyalty](https://www.researchgate.net/publication/277681499_The_Experience_Economy_Approach_to_Festival_Marketing_Vivid_Memory_and_Attendee_Loyalty)
- Merriam-Webster. (n.d.). Escapism. In Merriam-Webster.com dictionary. Retrieved Disember 5, 2022, from <https://www.merriam-webster.com/dictionary/escapism>
- Oh, H., Fiore, A. M., & Jeoung, M. (2007). Measuring experience economy concepts: Tourism applications. *Journal of Travel Research*, 46(2), 119–132. doi:10.1177/ 0047287507304039  
<https://journals.sagepub.com/doi/10.1177/0047287507304039>
- Patwary, A. K., Roy, B., Hoque, R., & Khandakar, M. S. A. (2019). Process of developing a community based tourism and identifying its economic and social impacts: An Empirical study on Cox's Bazar, Bangladesh. *Pakistan Journal of Humanities and Social Sciences*, 7(1), 1-13.
- Paula Alexandra Heliodoro., & Sameer Hosany: Pine and Gilmore's Concept of Experience Economy and Its Dimensions: An Empirical Examination in Tourism. October 2011 *Journal of Quality Assurance in Hospitality & Tourism* 12(4):237-255  
[https://www.researchgate.net/publication/326102359\\_Experience\\_economy\\_in\\_the\\_hospitality\\_and\\_tourism\\_context](https://www.researchgate.net/publication/326102359_Experience_economy_in_the_hospitality_and_tourism_context)
- Pine, J.B. II & Gilmore, J.H. (1998). "Welcome to the Experience Economy." *Harvard Business Review*, Vol.76, No.4, pp.97-106.
- Pine, J.B. II & Gilmore, J.H. (1999). The Experience Economy: Work is Theatre and
- Pine, J.B. II & Gilmore, J.H. (2004). "Trade in Ads for Experience." *Advertising Age*, Vol.75, No.39, pp.36.
- RACHEL Chan Suet Kay, Universiti Kebangsaan Malaysia Jebat: *Malaysian Journal of History, Politics & Strategic Studies*, Vol. 47 (3) (December 2020): 376-402  
<https://www.ukm.my/kita/wp-content/uploads/Dr-Rachel-Chan-CV-June-2021.pdf>
- Reinhold. [https://www.academia.edu/1256281/Festivals\\_special\\_events\\_and\\_tourism](https://www.academia.edu/1256281/Festivals_special_events_and_tourism)
- SIC (2000). "2 Billion TV Viewers Expected for Malaysian Grand Prix 2000", Press Release. Sepang International Circuit Sdn. Bhd., September 12.  
<https://ir.unimas.my/id/eprint/7100/1/An%20analysis%20of%20event%20tourism%20in%20malaysia.pdf>
- Soyoung Boo & James A. Busser (2018): Tourists' hotel event experience and satisfaction: an integrative approach, *Journal of Travel & Tourism Marketing*, DOI:

- Sumethokula, P., Patwary, A. K., Srinuanpanc, B., Srinuanpand, C., Suwandee, P., Thammathikulf, A., & Phanong, W. (2020). The potential of new tour repackaging for creative tourism among entrepreneurs in Nakhon Si Thammarat. *International Journal of Innovation, Creativity and Change*, 13(10), 1752-1771.
- Wu, B., Liu, S., Wang, J., Tahir, S., & Patwary, A. K. (2021). Assessing the mechanism of energy efficiency and energy poverty alleviation based on environmental regulation policy measures. *Environmental Science and Pollution Research*, 28, 40858-40870.
- Wu, B., Zhai, B., Mu, H., Peng, X., Wang, C., & Patwary, A. K. (2021). Evaluating an economic application of renewable generated hydrogen: A way forward for green economic performance and policy measures. *Environmental Science and Pollution Research*, 1-15.

# FACTORS INFLUENCE KELANTAN EXPERIENCE TOURISM AMONG UMK STUDENTS

*NUR ATIQAH BINTI RAMLI, NUR AWATIF BINTI ABDUL RAHIM, NUR AZHIEN BINTI MOHAMED AMIN, NUR AZLINDA BINTI SAIFUL & \*MRS. FADHILAHANIM ARYANI BINTI ABDULLAH. Faculty of Hospitality, Tourism, and Wellness, Universiti Malaysia Kelantan*

*Corresponding email: [aryani.a@umk.edu.my](mailto:aryani.a@umk.edu.my)*

---

## ABSTRACT

The study aims to examine university students on factors which include online review, value capture and security that influence Kelantan as experience tourism. A questionnaire was used as the data source. The results of the study revealed that the factors are of significant relevance to university students. Both academics and practitioners can benefit from the findings. Additionally, the report ends with suggestions for institutions on how to approach the problems mentioned.

**Keywords:** Experience tourism, online review, value capture, security

---

## INTRODUCTION

One of the sectors with the highest growth rates is tourism, which helps many countries create a lot of jobs and foreign cash. In fact, it's among the most amazing economies and societies. The Malaysian economy has benefited most from the tourism sector. Similarly, it also stimulate the global economic growth (Nasir and Wongchestha, 2022). Malaysia is one of the world's top tourist destinations, and its expansion in other linked industries, directly and indirectly, leads to job creation there (Abd Al Khuja, 2014). The primary segment of the tourism industry is discussed in this paper. For a greater understanding of the tourism industry sector, it offers a comprehensive overview.

There are three objectives of this research:

1. To determine the relationship between online reviews and Kelantan experience tourism.
2. To identify the relationship between value capture and Kelantan experience tourism.
3. To examine the relationship between security and Kelantan experience tourism.

## **SIGNIFICANCE OF THE STUDY**

The tourism industry should promote products based on tourism experiences to attract high-quality tourists, leading to long-term and lucrative income for the country. Director General of Tourism Malaysia, Datuk Musa Yusof, highlighted the high demand for this type of tourism, particularly in Malaysia, known for its rich flora, fauna, and well-preserved rainforests. Experiential tourism focuses on exploring the atmosphere, history, local community, culture, food, and environment of a specific place. Word-of-mouth testimonials are a cost-effective and widespread method to promote this form of tourism. Additionally, Malaysia's diverse races and cultures serve as the main attraction, offering unique cultural experiences such as festivals and traditional cuisine for tourists to enjoy.

## **LITERATURE REVIEW**

### **Research Hypothesis**

#### **1. Kelantan Attraction (DV)**

Kelantan, one of Malaysia's captivating and historic tourist destinations, attracts visitors with its inexpensive and valuable antique items. Despite its small size, Kelantan's agriculture industry contributes significantly to the nation's economy. The cultural aspect of travel is a major draw for tourists, and efforts have been made to enhance traditional folk entertainment for a better appreciation of Kelantan's stunning scenery. Kelantan is well-known for attracting many tourists, and increasing domestic and foreign visitors can drive economic growth in the state. Visitors' exposure to Kelantan's remarkable attractions sparks their desire to experience the destination, and they often share their experiences with others. The tourism journey in Kelantan defines the overall experience, providing knowledge and opportunities to explore interesting locations. Various options, facilities, and technologies cater to diverse experiences, offering both physical and mental variety.

#### **2. Experience Tourism (DV)**

Tourism experience refers to the moment when tourism consumption and production intersect, involving the acquisition of skills and behaviors through travel. It is influenced by the multi-sensory, fantastical, and emotional nature of tourism products, impacting tourist behavior. Travelers can shape their own experiences by engaging in events, activities, and interactions outside their homes. These experiences create personal narratives, memories, and emotions associated with the visited place. Tourism experiences involve traveling, learning, and participating in activities

away from home, contributing to the co-creation of ideas and productive outcomes. Such experiences cater to individual desires, ranging from enjoyment to the search for meaning.

### **3. Online Review (IV 1)**

Online customer reviews are critiques written by customers after using or purchasing a product or service. These reviews contribute to big data in the services sector and can be found on various online platforms. They provide valuable information and feedback on whether a product or service lives up to its claims. Social media platforms enable users to create, share, and exchange ideas and information through virtual communities and networks. The Office of Communications and Marketing manages major social media accounts and offers tools and consultations to establish and maintain a social media presence. Online comments and reviews on social media platforms provide insights into the experiences of customers who have used specific products or services. Positive online reviews with high emotional intensity are more likely to influence travel intentions compared to negative reviews. These reviews play a role in shaping tourists' desires and identifying interesting attractions and activities.

### **4. Value Capture (IV 2)**

Value capture refers to the process of retaining a portion of the value provided in every transaction. In the context of tourism, tourists seek experiences that they believe will offer them more value than what they are paying for. Establishing sustainable trust between customers, company providers, and society is crucial for effective value capture. It is essential for tourism companies to assess their ability to extract value from customers, as it leads to increased company value and customer satisfaction. By adding value through experiential tourism, economies in the tourism industry can expand globally and reduce reliance on traditional sectors such as clothing, agriculture, and commodity exports.

### **5. Security (IV 3)**

Security incidents significantly impact tourists' risk perception and travel decisions. Managing safety and security in the tourism sector is crucial to maintaining the popularity of a tourist destination. It involves addressing the concerns of visitors in navigating unfamiliar environments, understanding local customs, interpreting social cues, and ensuring confident purchasing experiences. Peace and hospitality are essential for successful travel and tourism, while war and insecurity are detrimental. When evaluating destination behavior during a crisis, it is important to consider the proactive or reactive measures taken by the destination and its involvement with interested parties aiming to minimize the impact. Providers in the tourism industry must

understand how risk influences consumer behavior and how travel information affects destination selection and travel behavior. The government, along with the Ministry of Tourism and Culture and tourism industry stakeholders in Malaysia, should take the initiative to manage tourism risks through strategic cooperation between local authorities, tourism companies, and local communities. This proactive approach aims to mitigate the risk of future unwanted events.

### **Research Hypothesis**

In this study, there were three hypotheses:

H1: There is a significant relationship between online review and Kelantan experience tourism. H2: There is a significant relationship between value capture and Kelantan experience tourism. H3: There is a significant relationship between security and Kelantan experience tourism.

### **Research Framework**

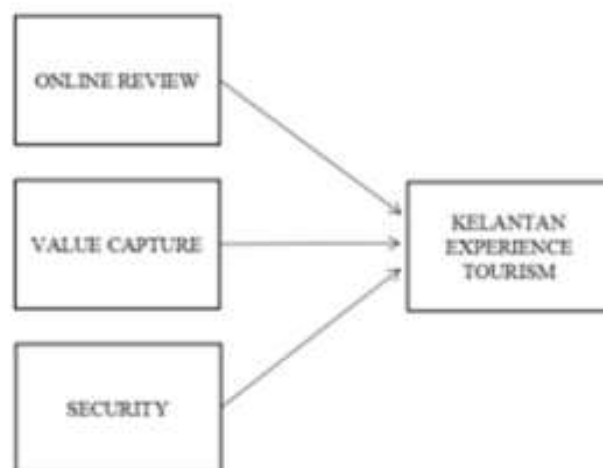

## **METHODOLOGY**

### **Research Design**

Research design refers to the framework and techniques used by a researcher to conduct a study. It specifies the process followed to test hypotheses or achieve study objectives. The choice of research design is crucial as it determines how information is gathered and reported. Research design can be categorized into exploratory, descriptive, and causal research. Data collection methods can be classified as primary (including qualitative and quantitative) and secondary. In this study focusing on UMK students' experiences, a quantitative method will be used to obtain accurate data.



## **Data Collection**

Data collection is the methodical process of acquiring observations or measurements. Whether you are conducting research for corporate, governmental, or academic reasons, data collection helps you to gain first-hand information and distinctive insights into your study problem. A pilot study will be done to confirm that it will be applied to test the viability of recruiting, randomization, retention, assessment protocols, novel approaches, and application of the novel intervention. The researcher distributes the questionnaires online using a Google Form through WhatsApp group and email. Once the number of students' answers is sufficient, the Google Form will be closed. All data will be recorded and stored for the use of this study.

## **Sampling**

Sampling is the process of selecting a subset of a larger population to be studied. Its goal is to gather information from a smaller group to make conclusions about the larger population. The key is to choose a representative sample that includes all relevant factors present in the population. There are two main types of sampling methods: probability sampling and non-probability sampling. In this research, non-probability sampling, specifically purposive sampling, will be used. Out of 11,413 UMK students, a random selection of 375 respondents will be surveyed using questionnaires distributed through WhatsApp groups or email. The focus will be on exploring the students' experiences related to Kelantan's tourism.

## **Data Analysis**

Data analysis is a systematic approach that involves applying mathematical and logical methods to interpret, summarize, and analyze data. Its purpose is to extract meaningful insights from the data and make informed decisions based on the analysis. Various analytical techniques are used to draw inferences and distinguish significant patterns from statistical fluctuations in the data. The goal is to derive valuable information from the data and use it to inform decision-making processes.

## **FINDINGS**

### **Result of Frequency Analysis**

Table 1: Demographic Analysis

<b>CHARACTERISTIC</b>		<b>FREQUENCY</b>	<b>%</b>
Gender	Male	154	40.6
	Female	225	59.4
Age	18 - 20 years old	49	12.9
	21 - 23 years old	190	50.1
	24 - 26 years old	106	28.0
	27 years old and above	34	9.0
Religion	Muslim	239	63.1
	Buddhist	49	12.9
	Christian	51	13.5
	Hindu	40	10.6
Year of study	1	42	11.1
	2	65	17.2
	3	143	37.7
	4	100	26.4
	Postgraduate	29	7.7

Source of funds	Parents	52	13.7
	PTPTN	211	55.7
	Loan	93	24.5
	Self-employed	23	6.1

The respondent profile is summarized in Table 1. The total number of respondents for males and females was 154 and 225. The percentage of male respondents was 40.6% while females were 59.4%. The highest percentage of age was 21 - 23 years old which is 50.1% (190 respondents). The second highest is for 24 - 26 years old with 28% (106 respondents), followed by those by 18 - 20 years old with 12.9% (49 respondents) and the lowest percentage of age is 27 years old and above with 9% (34 respondents).

Next, the analysis showed that the total number of respondents for the Muslim religion is the highest, which is 239 respondents (63.1%). The lowest is Hindu religion with 40 respondents (10.6%). The Buddhist religion is 49 respondents (12.9%) and Christian religion, has 51 respondents (13.5%).

Besides that, the analysis of years of study of year 3 was the highest percentage which is 37.7% with 143 respondents. The second highest percentage of years of study was year 4, which is 26.4% with 100 respondents. followed by year 2 with 17.2% (65 respondents), then year 1 with 11.1% (42 respondents). The lowest percentage of respondents for a year of study is post graduate which is 7.7% with 29 respondents.

Furthermore, the analysis of the source of study for the highest number of respondents was PTPTN which has 211 respondents with 55.7%. The next is a loan which is 93 respondents with 24.5%. Followed by the source of study for parents which is 52 respondents with 13.7%. The last is the lowest number of respondents of source of study for self-employed which is 23 respondents

with 6.1%.

### Result of Descriptive Analysis

This study has analyzed the mean and standard deviation for sections B, C, D and E of the questionnaires.

Table 2: Descriptive Analysis

<b>VARIABLE</b>	<b>ITEMS</b>	<b>MEAN SCORE</b>	<b>STANDARD DEVIATION</b>
Online review	I agree that advertising through social media influenced the choice of the holiday destination in Kelantan.	4.28	0.653
	I agree that advertising on mobile apps (Facebook, Instagram & TikTok) influenced my desire to go on vacation in Kelantan.	4.31	0.665
	I agree that the website has the potential to influence my intention to go on vacation to Kelantan.	4.33	0.679
	I agree that quality blogs influence my intention to visit Kelantan.	4.37	0.664

	I agree that positive online feedback such as on YouTube can influence to visit Kelantan.	4.38	0.677
Value Capture	I agree that physical facilities such as banks and business premises can attract my interest in visiting Kelantan.	4.30	0.637

Kelantan Experience Tourism	I think the cost of travel affects the choice of tourist destinations in Kelantan.	4.17	0.637
	I think the attraction of tourism in Kelantan influences the choice of travel destination.	4.26	0.637
	I think the availability of information about accommodations affects the choice of tourist destinations in Kelantan.	4.26	0.685
	I think Kelantan is famous for having a wide variety of interesting foods.	4.37	0.691
	I think the price factors of affordable product sales affect the choice of tourist destination in Kelantan.	4.27	0.653

The mean and standard deviation analyses were on the independent variable, the online review factor. The highest mean score was 4.38 where the respondents agree that positive online feedback such as on YouTube can influence them to visit Kelantan. The lowest score for online review was 4.28 where the respondents agree that advertising through social media influenced the choice of holiday destination in Kelantan.

The mean and standard deviation analyses of respondents for the second independent variable which is value capture. The highest mean score for value capture was 4.41 where the respondents agree that shared homestay experiences can attract visitors to Kelantan. The lowest score of value capture was 4.30 where the respondents agree that physical facilities such as banks and business premises can attract my interest in visiting Kelantan.

The mean and standard deviation analyses of respondents for the third independent variable which is security. The highest mean score for security was 4.47 where the respondents feel comfortable staying at an accommodation that has high-security features. The lowest score for security was 4.21 where the respondents think Kelantan has maximum safety features when doing activities.

The mean and standard deviation analyses of respondents for dependent variable which is Kelantan experience tourism. The highest mean score for Kelantan experience tourism was 4.37 where the respondents Kelantan is famous for having a wide variety of interesting foods. The lowest score for Kelantan experience tourism was 4.17 where the respondents think the cost of travel affects the choice of tourist destinations in Kelantan.

### **Result of Reliability Analysis**

A reliability analysis was used based on the internal consistency items that represent the factor influencing Kelantan experience tourism as well as the overall scale. The reliability analysis used Cronbach's Alpha Coefficient.

Table 3: Reliability Analysis

<b>VARIABLES</b>	<b>NUMBER OF QUESTIONS</b>	<b>CRONBACH'S ALPHA COEFFICIENT</b>	<b>STRENGTH OF ASSOCIATIONS</b>
Online review	5	0.727	Good
Value capture	5	0.723	Good
Security	5	0.692	Good
Kelantan experience tourism	5	0.614	Good

Cronbach's Alpha Coefficient values for independent variables and dependent variables in this study were more than 0.6. The conclusion presented was considered reliable and may be accepted in this study. The online review of the factors that influence Kelantan experience tourism among UMK students was measured using five questions, and Cronbach's Alpha Coefficient results for this section was 0.727 and which is considered good. As a result, the coefficients produced for the online review variable questions were reliable.

Besides that, the value capture of the factors that influence Kelantan experience tourism among UMK students was measured using five questions. Cronbach's Alpha Coefficient result for the value capture section was 0.723. This is considered good. As a result, the coefficients produced for this section's questions were reliable.

Furthermore, there were another five questions for the security section of the factor influencing Kelantan experience tourism among UMK students. Cronbach's Alpha Coefficient result for the security section was 0.692 and this is considered good. As a result, the coefficients calculated for the security variables were reliable.

Finally, another five questions were used to measure the Kelantan experience of tourism among UMK students and Cronbach's Alpha Coefficient result for this section was 0.614. This is

considered good. As a result, the coefficients may be concluded that this study was reliable.

### Pearson Correlation

Table 4: Pearson Correlation Analysis

HYPOTHESIS	P-VALUE	RESULT (SUPPORTED/NOT SUPPORTED)
H1: There is a significant relationship between online review and Kelantan experience tourism among UMK students.	0.520	H1 is supported
H2: There is a significant relationship between value capture and Kelantan experience tourism among UMK students.	0.582	H2 is supported
H3: There is a significant relationship between security and Kelantan experience tourism among UMK students.	0.520	H3 is supported

Table 4 shows the result of the Pearson Correlation Analysis of factor influence Kelantan experience tourism among UMK students. The p-value of online review of Kelantan tourism experience is  $<0.001$  which is less than the very significant level at 0.001. The relationship between online review and Kelantan experience tourism is moderate with a correlation value of 0.520.

Then, the relationship between value capture and Kelantan experience tourism with p-value is  $<0.001$  which is less than the significant level at 0.001. A correlation value of 0.582 shows that there was a moderate correlation between value capture and Kelantan experience tourism.

Finally, for the security factor, the p-value is  $<0.001$  which is less than the very significant level at 0.001. The correlation value of 0.520 revealed a moderate relationship between security and



Kelantan experience tourism.

## **DISCUSSION AND RECOMMENDATION**

An important and substantial step for finishing the research has been encountered throughout the entire project. However, permitting research to proceed as intended comes with some built-in limitations. There are serious issues with the current study that must be acknowledged. The first drawback of this study was the lengthy period needed to complete all of the data collection. The researchers went above and beyond to get in touch with the respondent right away.

The survey participants' unwillingness to participate in responding to the online questionnaire. Since it is difficult to locate travellers to perform in-person surveys for this study, all information must be entered online. Online polls that were shared through Facebook pages, Instagram, and WhatsApp groups had little responses. Researchers often had to submit the survey and make requests to the respondents in order to get their participation.

This study reveals the factors that influence Kelantan experience tourism, such as online review, value capture and security. It also recommends using qualitative methods to collect information more specifically and accurately. A structured face-to-face interview is better for getting a clear and precise response from the respondents, while a one-sided data source using a questionnaire may not be accurate. The researcher must first identify the intended target responder, who should be familiar with the study's title. Finding a good target responder is important if the respondents still do not understand the complexity of the study's topic.

This research should larger the sample size to increase the realizability of the study. Data collection questionnaires should be placed in every travel agency that provides Kelantan tourism experience, and early stages should include joining active groups with a connection to the study's subject. Additionally, more variables should be taken into consideration, such as online review, value capture, and security. These three variables have a minor amount of connection with the dependent variables.

## CONCLUSION

This study concludes that all three factors which are online review, value capture and security are significant in Kelantan experience tourism. The exchange of tourist experiences should be used as a strategy to boost tourism in Kelantan and bring in more visitors. To learn more about tourism in Kelantan, students who are studying there should visit attractive locations. The findings of this study may clarify what motivates students to experience tourism. A representative population sample should be considered in future studies. The results will be inconsistent if the sample is unbalanced. The sample size needs to be raised after that to obtain exact, accurate, and consistent results. To learn more aspects that affect visitors' decisions to travel to Kelantan, researchers might also consider combining more variables.

## REFERENCES

- Akter, M., Sadekin, M. N., & Patwary, A. K. (2020). An Empirical Study on Students' Satisfaction from Mawlana Bhashani Science & Technology University, Bangladesh. *Review of Economics and Development Studies*, 6(2), 363-379.
- Alom, S., Patwary, A. K., & Khan, M. M. H. (2019). Factors affecting the turnover intention of Bangladeshi migrants in the United Arab Emirates: An empirical study on the hotel industry. *International Journal of Innovation, Creativity and Change*, 8(3), 344-360.
- Awang, Z. (2012). *Research Methodology and Data Analysis Second Edition*. In *Google Books*. UiTM Press.
- Bachok, S., Hasbullah, H., & Ab Rahman, S. A. (2018). HOMESTAY OPERATION UNDER THE PURVIEW OF THE MINISTRY OF TOURISM AND CULTURE OF MALAYSIA: THE CASE OF KELANTAN HOMESTAY OPERATORS. *PLANNING MALAYSIA*, 16. <https://doi.org/10.21837/pm.v16i6.472>
- Fadli, B. (2022, September 30). *Jumlah permohonan tinggi punca calon tidak terima tawaran ke Universiti Awam*. *Harian Metro*. <https://www.hmetro.com.my/mutakhir/2022/09/886966/jumlah-permohonan-tinggi-punca-calon-tidak-terima-tawaran-ke-universiti-awam>
- Fang, B., Ye, Q., Kucukusta, D., & Law, R. (2016). Analysis of the perceived value of online tourism reviews: Influence of readability and reviewer characteristics. *Tourism Management*, 52, 498–506. <https://doi.org/10.1016/j.tourman.2015.07.018> *Google Books*. (n.d.-c). <https://books.google.com.my/?hl=en>
- Fengmin, Z., Baijun, W., Jiangtao, B., Li, L., & Patwary, A. K. (2022). Investigating revisit intention of medical tourists in China through nutritional knowledge, perceived medical quality, and

- trust in the physiologist: A recommendation on health tourism policy measures. *Frontiers in Public Health*, 10, 893497.
- Flanagin, A. J., & Metzger, M. J. (2011). FROM ENCYCLOPÆDIA BRITANNICA TO WIKIPEDIA. *Information, Communication & Society*, 14(3), 355–374. <https://doi.org/10.1080/1369118x.2010.542823>
- George, R. (2003). Tourist's perceptions of safety and security while visiting Cape Town. *Tourism Management*, 24(5), 575–585. [https://doi.org/10.1016/s0261-5177\(03\)00003-7](https://doi.org/10.1016/s0261-5177(03)00003-7)
- Hazbar, A. M. H., Alem Mohammed, A., & Karim, A. K. A. (2019). An Empirical Study of Factors Influencing hotel customers' online booking Intention. *مجلة العلوم التربوية و الدراسات الإنسانية*, (5), 1-17.
- Kalvelage, L., Revilla Diez, J., & Bollig, M. (2020). How much remains? Local value capture from tourism in Zambezi, Namibia. *Tourism Geographies*, 24(4–5), 759–780. <https://doi.org/10.1080/14616688.2020.1786154>
- Li, L., Ragavan, N. A., Patwary, A. K., & Baijun, W. (2022). Measuring patients' satisfaction toward health tourism in Malaysia through hospital environment, nutritional advice, and perceived value: A study on Chinese exchange students. *Frontiers in public health*, 10, 893439.
- Li, L., Wu, B., & Patwary, A. K. (2022). How marine tourism promote financial development in sustainable economy: new evidences from South Asia and implications to future tourism students. *Environmental Science and Pollution Research*, 29, 1155-1172.
- Li, L., Wu, B., & Patwary, A. K. (2022). The psychosocial factors affecting chinese Outbound Exchange and mobility students' academic performance during COVID-19. *Frontiers in psychology*, 13, 872516.
- Maski, G., Fadli, F., & Sumantri, V. D. S. (2020). Does tourism growth create a trickle-down effect in rural areas. *International Journal of Services, Economics and Management*, 11(3), 191. <https://doi.org/10.1504/ijsem.2020.111175>
- Nasir, M. N. M., & Wongchestha, N. (2022). Parallel Mediators of Place Attachment and Tourist Motivation in Involvement and Destination Loyalty: A Conceptual Model. *International Journal of Hospitality & Tourism Systems*, 15(2), 103-105.
- Patwary, A. K., Roy, B., Hoque, R., & Khandakar, M. S. A. (2019). Process of developing a community based tourism and identifying its economic and social impacts: An Empirical study on Cox's Bazar, Bangladesh. *Pakistan Journal of Humanities and Social Sciences*, 7(1), 1-13.
- Selby, M. (2004). *Understanding Urban Tourism: Image, Culture and Experience*. I.B. Tauris. Google Books. (n.d.). <https://books.google.com.my/?hl=en>
- Soh, R. C. (2021, August 25). Pelancongan di Kelantan rugi RM2.6 bilion. *Kosmo Digital*. <https://www.kosmo.com.my/2021/08/25/pelancongan-di-kelantan-rugi-rm2-6-bilion/>
- Songshan Huang, Hsu, C. H. C., & Chan, A. (2009). Tour Guide Performance and Tourist Satisfaction: A Study of the Package Tours in Shanghai. *Journal of Hospitality & Tourism Research*, 34(1), 3–33. <https://doi.org/10.1177/1096348009349815>
- Sumethokula, P., Patwary, A. K., Srinuanpanc, B., Srinuanpand, C., Suwandee, P., Thammathikul, A., & Phanong, W. (2020). The potential of new tour repackaging for creative tourism among entrepreneurs in Nakhon Si Thammarat. *International Journal of Innovation, Creativity and Change*, 13(10), 1752-1771.
- Tourist Satisfaction and Revisit Intention towards the Local Food Heritage in Kelantan. (2022).

*Asian Journal of Arts, Culture and Tourism*. <https://doi.org/10.55057/ajact.2022.4.3.2>  
*What is Tourism Experience | IGI Global*.  
(n.d.).<https://www.igi-global.com/dictionary/augmented-reality-for-smart-tourism-in-religious-heritage-itineraries/55467>

Westcott, M. (2021, June 4). 1.1 What is Tourism? – *Introduction to Tourism and Hospitality in BC – 2nd Edition*. Pressbooks. <https://opentextbc.ca/introtourism2e/chapter/what-is-tourism/>

*What is Tourism Experience*. (n.d.). Portugal Farm Experience. <https://www.portugalfarmexperience.com/blog/what-is-tourism-experience/>

Wu, B., Liu, S., Wang, J., Tahir, S., & Patwary, A. K. (2021). Assessing the mechanism of energy efficiency and energy poverty alleviation based on environmental regulation policy measures. *Environmental Science and Pollution Research*, 28, 40858-40870.

Wu, B., Zhai, B., Mu, H., Peng, X., Wang, C., & Patwary, A. K. (2021). Evaluating an economic application of renewable generated hydrogen: A way forward for green economic performance and policy measures. *Environmental Science and Pollution Research*, 1-15.

Živković, R., Gajić, J., & Brdar, I. (2014). The Impact of Social Media on Tourism. *Proceedings of the 1st International Scientific Conference - Sinteza 2014*. <https://doi.org/10.15308/sinteza-2014-758-761>

# Factors Encouraging Women Participation in Tourism

Azwa Hamidi, Dahlia Tagie, Faqihah Mohd Zaid, Farah Sazlan & Fadhilahanim  
Aryani Binti Abdullah

*Faculty of Hospitality, Tourism and Wellness, Universiti Malaysia Kelantan*

aryani.a@umk.edu.my

## ABSTRACT

Women have become more involved in the tourist business in Malaysia, and they have made major contributions to many different areas of the economy throughout the years. In Malaysia, a number of projects and programs had a particular emphasis on empowering women in the tourism sector. For instance, the Malaysian Association of Hotels (MAH) launched the Women in Hospitality and Tourism (WiHT) programme with the aim of encouraging leadership opportunities and professional development for women working in the hotel business. The primary goal of this study was to identify the factors that influenced women's participation in tourism. The Malaysian government's efforts to encourage its citizens to start businesses were evident. Targeted replies were from participants all around Malaysia, and 384 respondents successfully completed the online survey. The data was examined using SPSS version 29.0, which stands for Statistical Package for Social Science. SPSS Statistical was responsible for managing the complete statistical analysis process, encompassing planning, data collection, analysis, and reporting, to enhance performance and facilitate effective decision-making. In this study, the researchers utilized the Pearson correlation coefficient to investigate the association between skills and training, leadership, well-being, and digitalization toward women's participation in tourism. The results showed a significant effect of the relationship toward women's participation in tourism. Through this study, we could understand the skills and training, leadership, well-being, and digitalization that affected women's participation in tourism.

**Keywords:** women participation in tourism, Women involvement in the tourist business

## INTRODUCTION

The history of the study and the issues with research topic are covered in this chapter. In response to the problems mentioned in the research problem, research objectives are created. The significance of the study is discussed in the chapter's final section.

This study is done practically so that it can contribute to the improvement of women's participation and tourism in Malaysia. Women are regarded as cultural caretakers across the world. They are the chefs, weavers, farmers, and housewives, the keepers of traditions and

stories. According to academics, women who participate in tourism can increase their expertise. For example, they can learn a variety of languages based on the tourists that visit their locations. They can learn more about themselves because of this. According to research, a good quality education can have an influence on entrepreneurial growth by increasing an individual's self-efficacy and self-confidence (GEM, 2012)

Looking at the sector, women's engagement in tourism will boost the local economy. A strong association between gender and perceived business performance was discovered in the current study, suggesting that gender has a favourable influence on company success. A greater gender balance in entrepreneurship may indicate a better work-life balance for a society (GEM, 2013). Economic growth might benefit from persuading brilliant girls to consider establishing a firm and taking on the hurdles that may be tough for others. To that purpose, brave and entrepreneurial ladies might serve an essential role as role models or mentors.

When seen as a whole, this underlines the critical relationship between macroeconomic and social welfare policies for women to enjoy any real empowering effects from tourism engagement. There is frequently a schism between women who work in tourism, who are sometimes labelled "money ladies" because they earn money or "stand out," and other members of the community. This emphasises the significance of taking 'intersectionality' into account when creating gender equality measures in tourism. This includes considering women's many identities and privileges in terms of geography, race, nationality, socioeconomic background, disability, and other identity markers, as well as the intersections of these identities.

There are four objectives of this research:

- a. To examine the relationship between skills and training towards women participation in tourism.
- b. To examine the relationship between leadership towards women participation in tourism.
- c. To examine the relationship between well-being towards women participation in tourism.
- d. To examine the relationship between digitalization and participation towards women participation in tourism.

## **SIGNIFICANCE OF THE STUDY**

This study focuses on the importance of women's participation in tourism in Malaysia. Women are seen as cultural caretakers and can increase their expertise by learning different languages. A good quality education can have an influence on entrepreneurial growth by increasing self-efficacy and self-confidence. Women's engagement in tourism can also boost the local economy, and there is a strong association between gender and perceived business performance. To ensure gender equality in tourism, it is important to consider women's identities and privileges in terms of geography, race, nationality, socioeconomic background, disability, and other identity markers.

## LITERATURE REVIEW

This chapter reviews research in which female tourism participation is a dependent variable while skill and training, leadership, well-being, and digitization are independent variables. It also contributes to the formation of hypotheses and the research framework. A literature review is an academic piece of writing that displays knowledge and command of academic literature on a certain topic.

A skills training naturally is one that organisations offer to teach or strengthen workplace abilities. The tourism business employs about 200 million people, with women accounting for 70% of those jobs. Two of the biggest causes of this isolation are gender preconceptions and established gender standards. The MSME sector in the Philippines and India is critical for employment creation and entrepreneurship. Female leaders serve as role models for their subordinates.

WLT encourages and promotes women's participation in tourism's highest levels of corporate governance. Women should be allocated crucial positions for company leadership, as only 37% of managers, 28% of board members, and less than 1% of top executives are female. Well-being is both personal and subjective, and safety shields against both unintended and useful injury. The use of digital technologies to modify a business model and generate new revenue and value can be referred to as digitalization. Women micro entrepreneurs employ mobile technology to aid them with client payments and banking, and digital technologies increase access to markets, customers manufacturing technologies, marketing, and business information, knowledge, and resources.

The United Nations World Tourism Organisation (UNWTO) has chosen as its subject matter "Tourism Opening Doors for Women" for Tourism Day 2007. By setting up stalls, selling souvenirs and food, and connecting with hawkers, women in the industry of tourism contribute to the informal economy. Women contribute to family income, yet their influence in society stays limited. Women make up 46% of the workforce in the industry, which is higher than the global average of 34-40%. The proportion of women working in this sector varies greatly per country, ranging from 2% to more than 80%. Despite the lack of clear regional trends, it appears that women comprise roughly half of the workforce in countries with more developed industries such as tourism.

Brand image, skills and training, leadership, well-being, and digitalization all have a positive impact on women's participation in tourism. Skills and training have a positive impact, leadership has a positive impact, well-being has a positive impact, and digitalization has a positive impact. All of these factors have a positive impact on women's participation in tourism.

This chapter discusses the literature review, which includes two main variables: independent variable (IV) and dependent variable (DV). Independent variable (IV) is an attribute or function that can be counted, monitored, or manipulated, while dependent variable (DV) is an item that can be counted, monitored, or manipulated.



## RESEARCH HYPOTHESIS

The study's hypothesis is to determine whether there are any correlations or relationships between dependent variables and independent factors:

- H1: Skills and training have a significant relationship with the participation of women in tourism.
- H2: Leadership has a significant relationship with participation of women in tourism.
- H3: Well-being has a significant relationship with participation of women in tourism.
- H4: Digitalization has a significant relationship with the participation of women in tourism.

## RESEARCH FRAMEWORK

The Figure 1 below shows the research framework used for this study.

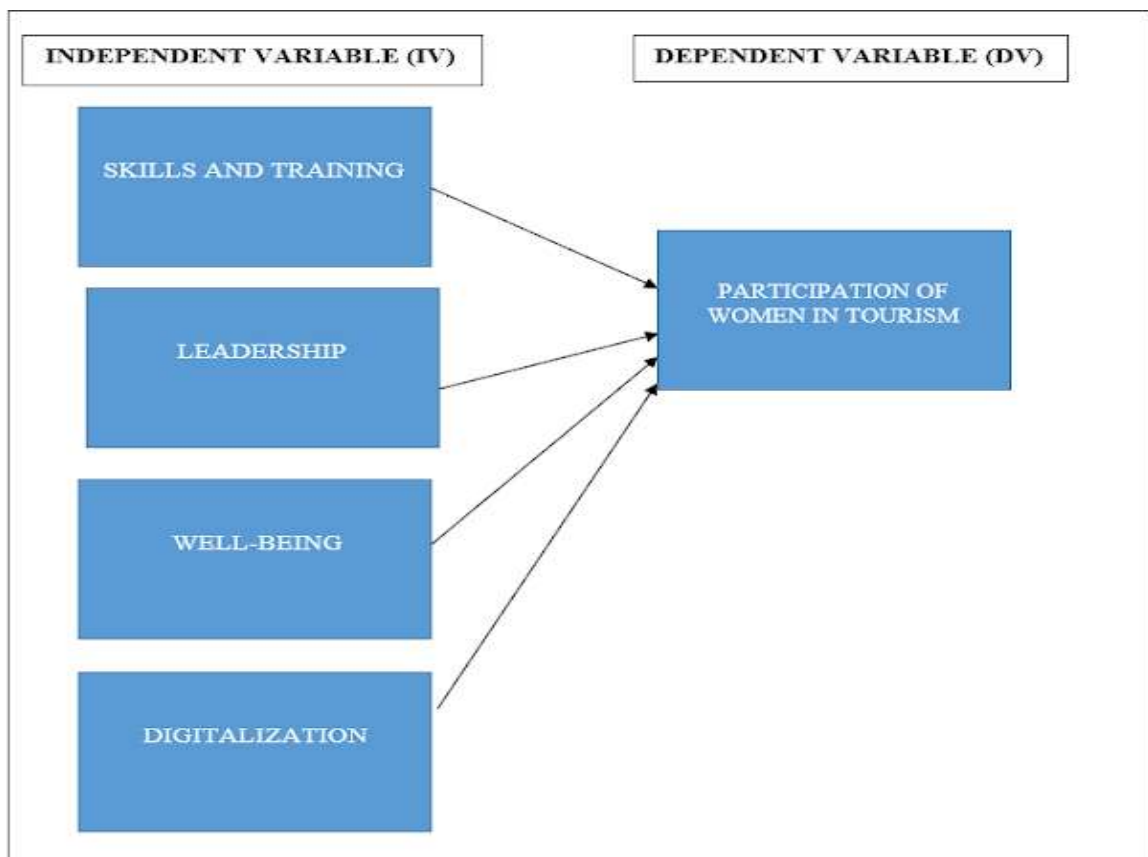

Figure 1: Research Framework

## **METHODOLOGY**

### **Research Design**

The research design is the overall approach you adopt for combining the various study components in a logical and persuasive manner that ensures you will effectively address the research topic. It serves as a road plan for data collection, measurement, and analysis.

The descriptive research approach is utilized in this study to describe anything that might be a phenomena or a present circumstance. This study will use a quantitative strategy to obtain data for the research by delivering a questionnaire to Malaysia residents. Quantitative research requires facts, logic, and an objective point of view. In contrast to divergent reasoning, quantitative research focuses on thorough, convergent reasoning. (Bhandari et al., 2020).

### **Population**

A population is a collection of people about whom you wish to draw conclusions. A gender questionnaire will be utilized to collect data for this investigation. Malaysia's population reaches one million people. Moreover, Malaysia is ranked among the top tourism destination in SouthEast Asia (Muhamad Nasir et al., 2022). To help our people, our researchers made the case for funding our study.

### **Sample Size**

To determine the sample size, Krejcie and Morgan (1970) sample was used in this study. Krejcie & Morgan (1970):

**Table 3.1**  
*Table for Determining Sample Size of a Known Population*

N	S	N	S	N	S	N	S	N	S
10	10	100	80	280	162	800	260	2800	338
15	14	110	86	290	165	850	265	3000	341
20	19	120	92	300	169	900	269	3500	346
25	24	130	97	320	175	950	274	4000	351
30	28	140	103	340	181	1000	278	4500	354
35	32	150	108	360	186	1100	283	5000	357
40	36	160	113	380	191	1200	291	6000	361
45	40	170	118	400	196	1300	297	7000	364
50	44	180	123	420	201	1400	302	8000	367
55	48	190	127	440	205	1500	306	9000	368
60	52	200	132	460	210	1600	310	10000	370
65	56	210	136	480	214	1700	313	15000	375
70	59	220	140	500	217	1800	317	20000	377
75	63	230	144	550	226	1900	320	30000	379
80	66	240	148	600	234	2000	322	40000	380
85	70	250	152	650	242	2200	327	50000	381
90	73	260	155	700	248	2400	331	75000	382
95	76	270	159	750	254	2600	335	1000000	384

*Note: N is Population Size; S is Sample Size* *Source: Krejcie & Morgan, 1970*

The exact amount of sample size for the population is 384.

### **Data Collection**

A process for acquiring and evaluating data for research and validation purposes is known as data collection. Data is gathered to look into an issue, find its solution, and identify potential future trends. Techniques for gathering data aid in decision-making. In this study, data collection methods used primary data that we will distribute using questionnaires to respondents to get the primary data. The survey will be delivered online, or it may go by another name, which is an online survey. A form may be a collection of queries or that aims to gather info from a respondent. A probe form frequently consists of both closed- and open-ended inquiries. The purpose of this analysis was identified within the covering letter within the form distributed to the respondents. Therefore, the respondents can perceive the motive and purpose of this study, so it permits respondents to produce additional correct info. After they finish, all the questionnaires will be collected, and then the researcher will count the number of questionnaires that will be distributed to them. Using the data collection procedure, a questionnaire, the researcher can save time, and this method is also relatively inexpensive.

### **Sampling**

For the research, a small group of people were chosen from a large population using the sampling method. A portion of the population was chosen by the researchers for additional examination during the sampling phase. Probability sampling and non-probability sampling are the two different categories of sampling procedures. In this research, non-probability sampling procedures were used because convenience sampling is simple to perform and cost-effective.

## Research Instrument

The quantitative method will be used in this study. The quantitative data collection method generates statistics (rather than meaning) through large-scale survey research using questionnaires.

Table 1: Measurement items

Measurements	Number of items in the questionnaires	Scales used	Author
Section A: Demographic information	6	Adapt	
(Dependent Variables) Section B: Women Participation in Tourism	5	Adopt	Serafimova et al., (2018)
(Independent Variables) Section C: Skills and Training	5	Adopt	Andrades et al., (2019)
(Independent Variables) Section D: Leadership	5	Adopt Alharthi,	Samad & (2022)
(Independent Variables) Section E: Well-being	5	Adopt et	Moreno-González al., (2020)
(Independent Variables) Section E: Digitalization	5		Khurramov et al., (2020)
Total	31		

## Data Analysis

This study utilized frequency, descriptive, and reliability analyses to demonstrate the links between dependent and independent variables. Using the Statistical Package for the Social Sciences (SPSS), the collected data were statistically processed through regression analysis.

## FINDINGS

### Demographic Profile of Respondent

#### Race

Table 4.3: Number of Respondents by Race

Gender	Percentage (%)	Cumul ative	Perce ntage (%)
	<b>F r e q u e n c y</b>		
<b>Chinese</b>	59	15.4	15
<b>Indian</b>			4
<b>Malay</b>	53		
<b>Others</b>		13.8	
<b>Total</b>	266		29
		69.3	2
	6		
		1.6	
	384		98
		100	4
			100

This table show the total respondents by race. 384 respondents—Malay (266), Chinese (59), Indian (53), and others (6)—completed the questionnaire. Figure 4.1 showed that most

respondents were Malay (69.3%), followed by Chinese (15.3%), Indian (13.8%), and others (1.5%).

### Age

Table 4.4: Number of Respondents by Age

Age	Percentage (%)	Cumulative Percentage
Frequency		

---

This table showed total responses by age. 384 people answered to the questionnaire: 1 under 20, 146 21-30, 145 31-40, 58 41-50, and 34 50+. Figure 4.2 indicated the biggest



percentage of responders was 21-30 years old (38.1%), followed by 31-40 years old (37.8%), 41-50 years old (15.1%), 50 and above years old (8.8%), and below 20 years old (0.3%).

## Education Level

Table 4.5: Number of Respondents by Education Level

Fields	Frequency	Percentage (%)	Cumulative Percentage (%)
<b>Degree</b>	308	80.4	80.4
<b>Master's</b>	8	2.1	82.5
<b>Others</b>	4	1.0	83.6
<b>SPM</b>	19	5.0	88.5
<b>STPM/Diploma/Matriculation</b>	44	11.0	100
<b>Total</b>	384	100.0	

This table showed total respondents by education level. Degree (308 respondents), Master's (8 respondents), SPM (4 respondents), STPM, Diploma, and Matriculation (19 respondents) completed the questionnaire. Figure 4.3 indicated the biggest percentage of responders was Degree (80.4%), followed by Master's (2.1%), SPM (5.0%), STPM, Diploma and Matriculation (11.0%), and others (1.0%).

## Marital Status

Table 4.6: Number of Respondents by Marital Status

Status	Frequency	Percentage (%)	Cumulative Percentage (%)

---

Married	192	50.0	50.0
Others	4	1.0	51.0
Single	188	49.0	100.0
Total	384	100.	
		0	

This table showed total marital status respondents. Marriage had 192 respondents, singles 188, and others 4. 49.0% of 384 respondents were single, 50.0% were married, and 1% were other participants.

**Field**

Table 4.7: Number of Respondents by Field

Field	Frequency	Percentage (%)	Cumulative Percentage (%)
Hotel and Resort Management	91	23.7	23.7
Marketing and Sales	60	15.6	39.3
Travel Agent	59	15.4	54.7
Tour Guides	24	6.3	61.0
Event Planning	58	15.1	76.1
Others	92	23.9	100.0
Total	384	100.0	

Percentage of Respondents by Field revealed field totals. Hotel & Resort Management led with 23.7% (91 respondents), followed by others with 23.9% (92 respondents). 15.6% (60 responses) for Marketing and Sales. Next were Travel Agents (15.4%, 59 respondents), Event Planning (15.1%, 58 respondents), and Tour Guides (6.3%, 24 respondents).

**State**

Table 4.8: Number of Respondents by State

State	Percentage (%)	Cumulative Percentage
Frequenc	y	(%)

Johor	21	5.5	5.5
Kedah	74	19.3	24.7
Kelantan	31	8.1	32.8
Melaka	21	5.5	38.3
Negeri Sembilan	8	2.1	40.4
Pahang	19	4.9	45.3
Perak	25	6.5	51.8
Perlis	25	6.5	58.3
Pulau Pinang	89	23.2	81.5
Sabah	11	2.9	84.4
Sarawak	2	0.5	84.9
Selangor	28	7.3	92.2
Terengganu	8	2.1	94.3
Wilayah Persekutuan Kuala Lumpur	22	5.7	100
Total	384	100	

From the table above, Pulau Pinang had 23.2% of responders (89), followed by Kedah with 19.3% (74). Kelantan had 8.1% (31 respondents) and Selangor 7.3% (28 respondents). 6.5% (25 people) were from Perak and Perlis. 5.7% (22 responses) from Wilayah Persekutuan Kuala Lumpur Melaka and Johor followed with 5.5% (21 respondents). Pahang (4.9%; 19 respondents), Sabah (2.9%; 11 respondents), Terengganu and Negeri Sembilan (2.1%; 8 respondents), and Sarawak (0.5%; 2 respondents) followed.

## Reliability Test

Alpha Coefficient Range	Strength of Association
< 0.6	Poor
0.6 to < 0.7	Moderate
0.7 to < 0.8	Good
0.8 to < 0.9	Very Good
0.9	Excellent

This Table Illustrates the overall consistency (pilot test) for the dependent and independent variable.

Table 4.2: Result of Reliability Coefficient Alpha for the Independent Variables and Dependent Variable

Variable	Number of items	Cronbach's Alpha coefficient	Strength of Association
Skills and Training	5	0.856	Very Good
Leadership	5	0.932	Excellent
Well-Being	5	0.942	Excellent
Digitalization	5	0.929	Excellent
Women Participation Tourism	5	0.936	Excellent
Overall variables	25	0.979	Excellent

This study's independent and dependent variables' Cronbach's Alpha Coefficients was shown in Table 4.2. From the table, all variables were over 0.7 and overall variables were 0.979.

Malaysian women's tourism participation was measured using five skills and training questions. Table 4.2 shows a very good Cronbach's Alpha of 0.856 for this section's question. Thus, the skills and training variable coefficients were accurate.

Five questions measured leadership's impact on Malaysian women's tourism. This section's Cronbach's alpha coefficient, 0.932, is excellent. Leadership variable coefficients were reliable.

Finally, five questions were utilized to measure the well-being variable that influenced Malaysian women's tourism. This section's Cronbach's Alpha was excellent at 0.942. Thus, wellbeing variable question coefficients were reliable.

Five questionnaires measured the digitalisation variable that affected Malaysian women's tourism industry engagement. The query's Cronbach's alpha score was 0.929, which is excellent. Thus, the coefficients for digitalization variable inquiries were reliable.

The Cronbach's Alpha for this section's question was 0.936, indicating outstanding. Thus, these questions' coefficients on Malaysian women's tourism involvement were credible. Since the variables' Cronbach's Alpha charge exceeded 0.7, surveys are credible, and the study can continue. Overall, reliability showed that respondents understood the questions, approving the questionnaires for this study.

## RESULT OF INFERENTIAL ANALYSIS

Pearson's correlation analysis was an essential linear connection analysis. This investigation examined independent variable-dependent variable correlations.



Table 4.15: Strength Interval of Correlation Coefficient

Size of Correlation	Interpretation
0.90 to 1.0 (-0.90 to 1.0)	Very high positive (negative) correlation
0.70 to 0.90 (-0.70 to -0.90)	High positive (negative) correlation
0.50 to 0.70 (-0.50 to -0.70)	Moderate positive (negative) correlation
-0.30 to 0.50 (-0.30 to -0.50)	Low positive (negative) correlation
0.00 to 0.30 (-0.00 to -0.30)	Negligible correlation

### Hypothesis 1: Skills and Training

H1: There is a relationship between skills and training towards women participation in tourism.

Table 4.16: Correlation coefficient for skills and training towards women participation in tourism.

W Skills and Training  
o  
m  
e  
n  
P  
a  
r  
t  
i  
c  
i  
p  
a  
t  
i  
o  
n  
i  
n  
T  
o  
u  
r  
i  
s  
m

---

Women Participation in Tourism	Pearson correlation	1	
		0.767*	
	Sig. (2-tailed)		*
			0
			.
			0
			0
			0
N	384	384	

Skills and Training	Pearson correlation	0.767**	1
	Sig. (2-tailed)	0.000	
	N	384	384

## Hypothesis 2: Leadership

H2: There is a relationship between leadership towards women participation in tourism.

Table 4.17: Correlation coefficient for leadership towards women participation in tourism.

		Women Participation in Tourism	Leadership
Women Participation in Tourism	Pearson correlation	1	0.793*
	Sig. (2-tailed)		0.000
	N	384	384
	Pearson correlation	0.793**	1

	correlat ion		
Leadership	Sig. (2- tailed)	0.000	
	N	384	384

H3: There is a relationship between well-being towards women participation in tourism.

Table 4.18: Correlation coefficient for well-being towards women participation in tourism.

---

	W o m e n P a r t i c i p a t i o n i n T o u r i s m	Wellbeing
--	---	-----------

---

Women Participation in Tourism	Pearson correlation	1	
		0.808*	
	Sig. (2- tailed)		0.000
	N	384	384
	Pearson correlation	0.808**	1
Well-Being	Sig. (2-tailed)	0.000	
	N	384	384

\*

H4: There is a relationship between digitalization towards women participation in tourism.

Table 4.19: Correlation coefficient for digitalization towards women participation in tourism.

	W Digitalization o m e n P a r t i c i p a t i o n i n T o u r i s m		
Women Participation in Tourism	Pearson correlation	1	0.794*
	Sig. (2- tailed)		0.000
	N	384	384
	Pearson correlation	0.794**	1

Digitalization	Sig. (2-tailed)	0.000	
	N	384	384

## DISCUSSION BASED ON RESEARCH OBJECTIVES

This literature review promotes female tourism. This study found a correlation between skills and training, leadership, well-being, and digitalization among women in tourism.

Hypothesis	Pearson's correlation results	
H1: There are relationship between skills and training among women participation in tourism	$r = 0.767, p < 0.01$	Strong
H2 : There are relationship between leadership among women participation in tourism	$r = 0.793, p < 0.01$	Strong
H3 : There are relationship between well-being among women participation in tourism	$r = 0.808, p < 0.01$	Strong
H4 : There are relationship between digitalization among women participation in tourism	$r = 0.794, p < 0.01$	Strong

The table confirmed that all hypotheses on skills and training, leadership, well-being, and digitalization among women in tourism were accepted through Pearson's correlation analysis at a 0.01 significance level. The results demonstrated a strong and positive correlation between the independent variables and women participation.

## RECOMMENDATIONS

Tourism can empower women. Tourism-related jobs and income can help women financially. Economic empowerment can improve their lives and their families, reducing poverty and promoting socio economic growth. Thus, empowering women requires this proposition. Education empowers Encourages women to study tourism. Encourage women to pursue tourism and hospitality management degrees or certificates to gain knowledge and

skills. Entrepreneurship and Business Training helps women start tourism-related enterprises. Help them with startup ideas, funding, marketing, and legal and regulatory issues. This can help women become tourism entrepreneurs and leaders.

## **CONCLUSION**

In conclusion, this study was done to investigate the variables that encourage women to travel. The influencing elements (independent variables) of leadership, well-being, digitization, and skills and training have an influence on women's engagement, which is a dependent variable. A Google Form containing 384 respondents was used by researchers, as described in Chapter 3, to distribute surveys to respondents who work in the tourism sector. To contact respondents across Malaysia, the researchers use a Google Form. This is due to the fact that utilising this Google Form makes it simpler for participants to complete all surveys, which in turn helps the researchers save time and money.

Numerous analyses, including frequency analysis, descriptive analysis, reliability analysis, and correlation analysis, were used to determine the findings of the questionnaire survey results. Next, the Statistic Package for the Social Science (SPSS) software programme was used to examine the results from the previous chapter as well as all of the data from the questionnaire. This software was chosen by the researchers because it makes it simple to access all the findings. Finally, a summary and conclusion of the final findings from the data analysis. All of the given hypotheses (H1, H2, H3, and H4) are accepted for this study. As well as analysing the results of the questionnaire survey, limits and suggestions were made for this research in the hopes that they may be useful for future investigations. It is thus also hoped that all the knowledge shared during this research may aid the following researche



## REFERENCES

- Akter, M., Sadekin, M. N., & Patwary, A. K. (2020). An Empirical Study on Students' Satisfaction from Mawlana Bhashani Science & Technology University, Bangladesh. *Review of Economics and Development Studies*, 6(2), 363-379.
- Alom, S., Patwary, A. K., & Khan, M. M. H. (2019). Factors affecting the turnover intention of Bangladeshi migrants in the United Arab Emirates: An empirical study on the hotel industry. *International Journal of Innovation, Creativity and Change*, 8(3), 344-360.
- Andrades, L., & Dimanche, F. (2019). Destination competitiveness in Russia: tourism professionals' skills and competences. *International Journal of Contemporary Hospitality Management*.
- Bloomberg, J. (2018). Digitization, digitalization, and digital transformation: confuse them at your peril. *Forbes*. Retrieved on August, 28, 2019.
- Camilleri, M. A. (2018). The tourism industry: An overview. *Travel marketing, tourism economics and the airline product*, 3-27.
- Fengmin, Z., Baijun, W., Jiangtao, B., Li, L., & Patwary, A. K. (2022). Investigating revisit intention of medical tourists in China through nutritional knowledge, perceived medical quality, and trust in the physiologist: A recommendation on health tourism policy measures. *Frontiers in Public Health*, 10, 893497.
- Hazbar, A. M. H., Alem Mohammed, A., & Karim, A. K. A. (2019). An Empirical Study of Factors Influencing hotel customers' online booking Intention. *مجلة العلوم التربوية و الدراسات الإنسانية*, (5), 1-17.
- Khurramov, O. (2020). The role of the tourism sector in the digitalization of the service economy. *Economics and Innovative Technologies*, 2020(1), 6.
- Li, L., Ragavan, N. A., Patwary, A. K., & Baijun, W. (2022). Measuring patients' satisfaction toward health tourism in Malaysia through hospital environment, nutritional advice, and perceived value: A study on Chinese exchange students. *Frontiers in public health*, 10, 893439.
- Li, L., Wu, B., & Patwary, A. K. (2022). How marine tourism promote financial development in sustainable economy: new evidences from South Asia and implications to future tourism students. *Environmental Science and Pollution Research*, 29, 1155-1172.
- Li, L., Wu, B., & Patwary, A. K. (2022). The psychosocial factors affecting chinese Outbound Exchange and mobility students' academic performance during COVID-19. *Frontiers in psychology*, 13, 872516.
- Mackenzie, S. H., Boudreau, P., & Raymond, E. (2020). Women's adventure tour guiding experiences: Implications for well-being. *Journal of Hospitality and Tourism Management, system* 45, 410-418.
- Micheletto, B. Z. (2022). A Difficult Matching: Female Artisans, Technical Knowledge and Inventions in Early Modern Savoy-Piedmont. In *The Republic of Skill* (pp. 223-245). Brill.
- Moreno-González, A.-A., León, C. J., & Fernández-Hernández, C. (2020). Health destination image: The influence of public health management and well-being conditions. *Journal of Destination Marketing & Management*, 16, 100430.
- Muhamad Nasir, M. N., Abdul Rahim, M., Hassan, S., & Muhamad, S. F. (2022). Developing a model of perceived value, quality of life, place attachment and destination loyalty. *Journal of Tourism, Hospitality and Culinary Arts*, 14(1), 85-95.

- Narwan, K., & Mulia, D. S. (2019). Impak ekopelancongan terhadap pemerksaan wanita, kesaksamaan gender dan pembangunan komuniti. *Malaysian Journal of Social Sciences and Humanities (MJSSH)*, 4(6), 139-151.
- Paoloni, P., Secundo, G., Ndou, V., & Modaffari, G. (2019). *Women entrepreneurship and digital technologies: Towards a research agenda*. Paper presented at the Advances in Gender and Cultural Research in Business and Economics: 4th IPAZIA Workshop on Gender Issues 2018, Rome, Italy 4.
- Patwary, A. K., Roy, B., Hoque, R., & Khandakar, M. S. A. (2019). Process of developing a community based tourism and identifying its economic and social impacts: An Empirical study on Cox's Bazar, Bangladesh. *Pakistan Journal of Humanities and Social Sciences*, 7(1), 1-13.
- Raihan, A., Voumik, L. C., Nafi, S. M., & Kuri, B. C. (2022). How Tourism Affects Women's Employment in Asian Countries: An Application of GMM and Quantile Regression. *Journal of Social Sciences and Management Studies*, 1(4), 57-72.
- Samad, S., & Alharthi, A. (2022). Untangling Factors Influencing Women Entrepreneurs' Involvement in Tourism and Its Impact on Sustainable Tourism Development. *Administrative Sciences*, 12(2), 52.
- Serafimova, M., & Petrevska, B. (2018). Female entrepreneurship in tourism: A strategic management perspective in Macedonia. *Journal of Applied Economics and Business*, 6(1), 21-32.
- Solina, M. F. L. (2020). Assessment of Business Environment of Women Involved in Micro, Small, and Medium Enterprises (MSMEs) in The Philippines: A Comparative Study with Select ASEAN Countries. *JAS (Journal of ASEAN Studies)*, 8(2), 191-211.
- Suess, C., Woosnam, K. M., & Erul, E. (2020). Stranger-danger? Understanding the moderating effects of children in the household on non-hosting residents' emotional solidarity with Airbnb visitors, feeling safe, and support for Airbnb. *Tourism Management*, 77, 103952.
- Sumethokula, P., Patwary, A. K., Srinuanpanc, B., Srinuanpand, C., Suwandee, P., Thammathikul, A., & Phanong, W. (2020). The potential of new tour repackaging for creative tourism among entrepreneurs in Nakhon Si Thammarat. *International Journal of Innovation, Creativity and Change*, 13(10), 1752-1771.
- Valeri, M., & Katsoni, V. (2021). *Gender and tourism: Challenges and entrepreneurial opportunities*: Emerald Group Publishing.
- WOMEN, A. PERANAN SEKTOR PELANCONGAN DALAM MENINGKATKAN PENDAPATAN GOLONGAN WANITA ORANG ASLI.
- Wu, B., Liu, S., Wang, J., Tahir, S., & Patwary, A. K. (2021). Assessing the mechanism of energy efficiency and energy poverty alleviation based on environmental regulation policy measures. *Environmental Science and Pollution Research*, 28, 40858-40870.
- Wu, B., Zhai, B., Mu, H., Peng, X., Wang, C., & Patwary, A. K. (2021). Evaluating an economic application of renewable generated hydrogen: A way forward for green economic performance and policy measures. *Environmental Science and Pollution Research*, 1-15.
- Zhu, H., & Deng, F. (2020). How to influence rural tourism intention by risk knowledge during COVID-19 containment in China: Mediating role of risk perception and attitude. *International journal of environmental research and public health*, 17(10), 3514.

# INTENTION TO USE METAVERSE IN TEACHING AMONG UNIVERSITI MALAYSIA KELANTAN LECTURER

*NUR FARAHANIM BINTI AZIZ, NUR FIZATULNISA BINTI BACHIK, NUR HANI MAISARAH BINTI MUHAMAD NIZAM, NUR HANIM FARISYA BINTI MOHD ZAIN & PN FADHILAHANIM ARYANI BINTI ABDULLAH*  
*Faculty of Hospitality, Tourism and Wellness, Universiti Malaysia Kelantan aryani.a@umk.edu.my*

---

## ABSTRACT

The study aims to investigate the way lecturers at University Malaysia Kelantan are influenced by the metaverse in their teaching in terms of performance expectancy, effort expectancy, and facilitating conditions. Questionnaires were used as the quantitative tool in the study. The results of this study have significance for learning and help to comprehend lecturers at the University Malaysia Kelantan's intentions of using the metaverse in their teaching.

**Keywords:** Intention to use metaverse, Performance expectancy, Effort expectancy and facilitating condition,

---

## INTRODUCTION

The purpose of this study is to investigate the intention to use Metaverse in teaching among University Malaysia Kelantan lecturer. The metaverse has been defined as a new internet iteration that makes use of virtual reality headsets, block chain technology, and avatars as part of a new fusion of the real and virtual worlds (Lee et al., 2021). Working with students to ensure that they understand and can put ideas, concepts, and processes into practise is referred to as teaching. It entails design, content selection, delivery, assessment, and reflection. The act of integrating pupils in the active construction of knowledge is known as teaching. To teach is to involve the learner in the process. The study aims to investigate the relationship between performance expectancy, effort expectancy and facilitating conditions and metaverse in teaching.

## SIGNIFICANCE OF THE STUDY

The metaverse provides virtual environments that can immerse students in realistic simulations and interactive experiences. By studying the metaverse, educators can design activities that engage students in experiential learning, allowing them to explore and interact with virtual objects, and gain practical skills in a safe and controlled environment. Global collaboration and intercultural understanding. The metaverse enables students from different geographical locations to collaborate, communicate, and learn together in virtual classrooms. By studying the metaverse, lecturer can facilitate global collaborations, fostering cultural exchange and creating opportunities for students to work with peers from diverse backgrounds. This promotes intercultural understanding and global citizenship.

## LITERATURE REVIEW

### **i) Intention to use metaverse (DV)**

The metaverse aims to build a digital universe that combines elements from the real and virtual worlds, such as simulated or mirrored environments, avatars, non-player characters, etc. Numerous modeling and simulation tools, including SketchUp, Unity, and Blender, are already available to create digital objects (Tlili et al., 2022). Therefore, "intention to use metaverse in teaching" refers to an individual's deliberate plan or inclination to employ the metaverse, which represents a virtual reality space or collective virtual shared space, for the purpose of facilitating teaching and learning activities. It suggests a conscious decision to leverage the metaverse's potential as a tool or platform for educational instruction and engagement.

### **ii) Performance Expectancy**

The concept of performance expectation has drawn significant attention from a number of authors and researchers working in a variety of human undertakings (Venkatesh, Morris, Davis, and Davis, 2003; Derntl, 2011; Khayati & Zouaoui, 2013, etc.). As noted by Rogers (2003), several of these studies made an effort to identify and apply the concept to explain information technology adoption and use. Performance expectation (PE) is the degree to which a person anticipates that implementing a system would enable him or her to enhance performance at work. (Venkatesh et al., 2003).

### **iii) Effort Expectancy**

The UTAUT model also includes a construct called effort expectation that gauges how simple an information technology is to use. According to Venkatesh et al. (2003), effort expectancy refers to how simple it is to utilize an information system. It implies that postgraduate students should not anticipate their use of smartphones to involve significant physical or mental work. The foundation of effort expectation is the notion that there are connections among the effort expended at work, the results obtained as a result of that effort, and the rewards obtained as a result of that effort. (Ghalandari, 2012).

### **iv) Facilitating Condition**

According to Venkatesh et al. (2003), the degree to which a person believes that the organisational and technological infrastructure is in place to facilitate usage of the system is known as the "facilitating condition." In the context of this study, it refers to the objective elements, such as infrastructure and resources that UMK lecturers want to employ in their instruction. According to Venkatesh et al. (2013), enabling conditions and behavioural intentions to use and accept technology have a favourable association. Age and experience did, however, mitigate the link, making it greater for older individuals with more experience. When both performance and effort expectation constructs are present, according to TPB and DTPB, enabling circumstances are insignificant and direct antecedents of usage (a characteristic also evident in MPUC).

### **Research Hypothesis**

H1: There is relationship between Performance expectancy and metaverse in teaching among UMK lecturer.

H2: There is relationship between Effort expectancy and metaverse in teaching among UMK lecturer.

H3: There is relationship between Facilitating condition and metaverse in teaching among UMK lecturer.

### Research Framework

Toward finishing the analysis, a conceptual framework might be used as a device for accumulating information on this research. Thus, this framework is likewise beneficial in describing the connection among impartial variables and based variables in the research.

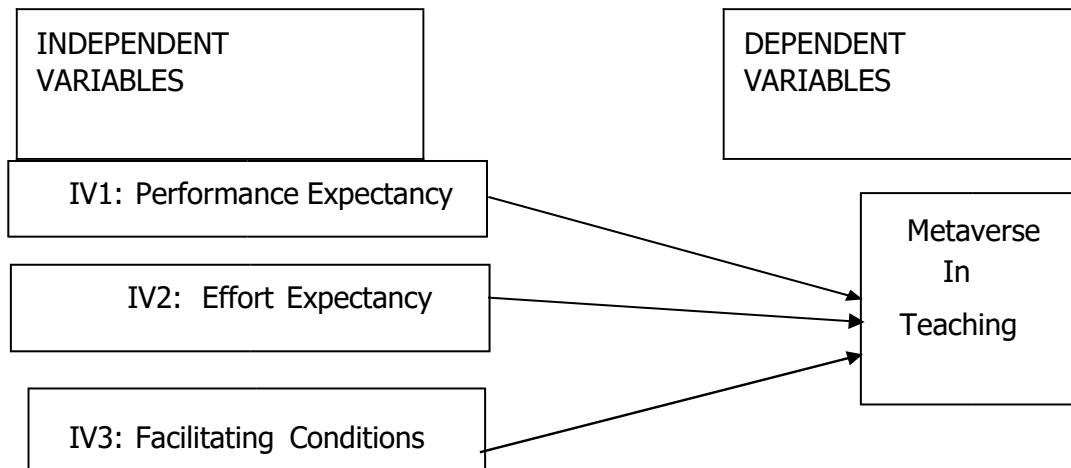

Figure 2.4 Conceptual Framework

## METHODOLOGY

### Research Design

Quantitative research places more focus on exact, convergent thinking than divergent reasoning (P. Bhandari, 2020). The quantitative study's design emphasises how events are judged and described in a detached way. This approach uses data, control, and statistics in the study design to maximise impartiality. As a result, this study employed a quantitative approach to gather its research data.

The study's primary data were collected using the quantitative research approach. Kumar claims that descriptive research may reveal everything, including trends, current events, and characteristics of a person, a group, or an organisation, among other things (2013). William (2011) defined quantitative analysis as the process of preparing data such that it can be quantified and statistically evaluated to establish or reject specific knowledge claims. This study examines the performance expectations, effort expectations, and facilitating condition of lecturer at UMK who use the Metaverse for teaching. Quantitative method is the best approach included surveys, observations for numeric information in this research.

### Data Collection

. The survey form has been applied to a wide range of fields, including politics, marketing research, and psychology. For the study, 123 questionnaires were collected. There are 123 questionnaires in total were given to lecturer in teaching at UMK. Based on their desire to take part in the survey, a random selection process was used to choose all respondents. When they're done, all the questionnaires will be collected, and the researcher will then count up how many questionnaires were given out overall. The researcher can conserve their time by employing the questionnaire-based data gathering approach.

## **Sampling**

A approach for selecting a small sample from a large population for research purposes is the sampling method. The researchers choose a subset of the population for further examination during the sampling phase. Probability and non-probability sampling techniques are the two main categories. Using probability theory, researchers select samples from a broader population. This method is known as probability sampling. This kind of sampling creates samples in accordance with the current procedure and takes into account every member of the population. In a non-probability sample, participants are chosen at random by the researcher. With this form of sampling, there is no predetermined or specified selection procedure. Convenience sampling is simple and affordable to do. In this investigation, we have chosen to use non-probability. Non-probability sampling was chosen because it is more efficient and less expensive than probability sampling because the researcher is already familiar with the sample.

## **Data Analysis**

Data analysis is done when a large quantity of data is gathered, and it turns the data into insightful knowledge that helps identify patterns. So, using the widely used statistical programme SPSS (Statistical Package for Social Science), the data analysis for the data instrument of this research study questionnaire was carried out. A number of analyses, including the descriptive analysis, reliability test, inferential analysis, and Pearson correlation, will be used to further support the results once each survey item has been individually investigated.

## FINDINGS

This chapter presents the results of a survey conducted with 123 lecturers from University Malaysia Kelantan. The survey data was analyzed using various methods, including frequency analysis, descriptive analysis, reliability analysis, reliability tests, and Pearson correlation coefficient analysis. The findings are discussed in relation to the research objectives. The survey included filter questions, and the demographic profile of the respondents, including gender, age, academic grade, and highest education, was collected and summarized.

### The number of respondents based on Gender

		Gender			
		Frequency	Percent	Valid Percent	Cumulative Percent
Valid	Female	88	71.5	71.5	71.5
	Male	35	28.5	28.5	100.0
	Total	123	100.0	100.0	

The statistic table that based on gender of the respondents. The total of all the respondents is 123 respondents. In this research, the female respondents have the highest percentage compared to the male. Female respondents have higher percentage with 71.5% (N=88) respondents. While male have 28.5% (N=35) respondents.

### The number of respondents based on Age

		Age			
		Frequency	Percent	Valid Percent	Cumulative Percent
Valid	30 years	39	31.7	31.7	31.7
	31 - 40	69	56.1	56.1	87.8
	Above 41	15	12.2	12.2	100.0
	Total	123	100.0	100.0	

Based on the result from, the table show the statistic table that based on age of the respondents. Out of 123 respondents the highest number of group age of 31-40 years old with 56.1% (N=69) respondents followed by second highest group age of 30 years old with 31.7% (N=39) respondents. As for the group age of above 41 the percentage is 12.2% (N=15) respondents.

### The number of respondents based on Academic Grade

		Academic Grade			
		Frequency	Percent	Valid Percent	Cumulative Percent
Valid	Lecturer	92	74.8	74.8	74.8
	Professo	15	12.2	12.2	87.0
	Senior L	16	13.0	13.0	100.0
	Total	123	100.0	100.0	

Table illustrate the frequency and status based on the academic grade of respondents. Out of 123 respondents 92 of them were lecturer with 74.8% (N=92) respondents while the other senior lecturer with 23.0 % (N=16) respondents and professor with 12.2% (N=15).

### The number of respondents based on Highest Education

		Highest Education			
		Frequency	Percent	Valid Percent	Cumulative Percent
Valid	Degree	14	11.4	11.4	11.4
	Doctor o	49	39.8	39.8	51.2
	Master	60	48.8	48.8	100.0
	Total	123	100.0	100.0	

Table illustrate the respondents based on their highest education. With 48.8% (N=60) respondents have a master. With 39.8% (N=49) of the respondents have doctor which is the second highest level of education. The followed by 11.4% (N=14) respondents have degree.

## DISCUSSION AND RECOMMENDATION

### LIMITATIONS

Throughout the study, a practical and reliable method for drawing conclusions has been encountered. However, permitting research to proceed as intended comes with some built-in limitations. There are serious issues with the current study that must be addressed. The respondents also expressed reluctance to participate in the online poll. The COVID-19 that has affected our country and other countries across the world has had a significant influence on the tourist industry. In order to collect all the information, it is difficult for researchers to collect data in person. Google Forms was used to distribute online surveys that collected data.



In order to encourage respondents to participate in this survey, researchers continuously implored them to do so.

### **Recommendation for UMK Lecturer's**

In Malaysia's Kelantan province, the majority of college lecturers want to incorporate the metaverse into their instruction. The metaverse has the potential to alter how lessons are taught in the classroom, electronically bring together teachers and students in one location, improve career preparation, and open up new options for lifelong learning. With the rise of the metaverse, information technology and artificial intelligence have stimulated educational innovation, altered traditional pedagogical ideas and techniques, and created the foundation for smart education.

### **Future Study**

For better research goals, this study employs quantitative approaches. However, since they take a different approach and can produce different information than quantitative approaches, researchers may choose to employ qualitative methods in the future to gather data. Utilising several methodologies is done to see whether the outcomes from earlier study differ. For instance, researchers may not get particular data when using quantitative approaches, but they are more likely to get precise data while utilising qualitative methods.

### **CONCLUSION**

The goal of this study, was to find out whether Universiti Malaysia Kelantan lecturers intended to use the metaverse for education. The study found that factors including performance expectations, effort expectations, and enabling circumstances all had a significant influence on people's motivation to use the metaverse. 123 research participants responded to questionnaires distributed through Google Forms. Data collection was made simple, cost-effective, and time-effective by using Google Forms. To assist with the descriptive, reliability, and inferential analyses of the gathered data, the SPSS software programme was employed. The results of the analysis supported all of the study's assumptions (H1, H2, H3, and H4). The study also identified its limitations and made recommendations for further investigation.

### **REFERENCES**

Akter, M., Sadekin, M. N., & Patwary, A. K. (2020). An Empirical Study on Students' Satisfaction from Mawlana Bhashani Science & Technology University, Bangladesh. *Review of Economics and Development Studies*, 6(2), 363-379.

- Alawadhi, M., Alhumaid, K., Almarzooqi, S., Aljasmī, S., Aburayya, A., Salloum, S. A., & Almesmari, W. (2022). Factors affecting medical students' acceptance of the metaverse system in medical training in the United Arab Emirates. *South Eastern European Journal of Public Health (SEEJPH)*.
- Alkharang, M. M. (2014). *Factors that influence the adoption of e-learning: An empirical study in Kuwait* (Doctoral dissertation, Brunel University London).
- Alom, S., Patwary, A. K., & Khan, M. M. H. (2019). Factors affecting the turnover intention of Bangladeshi migrants in the United Arab Emirates: An empirical study on the hotel industry. *International Journal of Innovation, Creativity and Change*, 8(3), 344-360.  
[andhttps://elearningindustry.com/advantages-and-disadvantages-online-learning/](https://elearningindustry.com/advantages-and-disadvantages-online-learning/)
- Bay Atlantic University. (2022, June 17). How Does Virtual Learning Impact Students in Higher Education? Bay Atlantic University - Washington, D.C. <https://bau.edu/blog/virtual-learning-in-higher-education/challengesconsTop-benefits-and-challenges>
- Chao, C. M. (2019). Factors determining the behavioral intention to use mobile learning: An application and extension of the UTAUT model. *Frontiers in psychology*, 10, 1652.
- EducationApplicationPlatform: Empirical Evidence Based on PPM and TAM  
Education.<https://drexel.edu/soe/resources/student-teaching/advice/benefits-of-onlineandvirtualllearning/>
- Fengmin, Z., Baijun, W., Jiangtao, B., Li, L., & Patwary, A. K. (2022). Investigating revisit intention of medical tourists in China through nutritional knowledge, perceived medical quality, and trust in the physiologist: A recommendation on health tourism policy measures. *Frontiers in Public Health*, 10, 893497.
- Fitria, T. N., & Simbolon, N. E. (2022). Possibility of metaverse in education: opportunity and threat. *SOSMANIORA: Jurnal Ilmu Sosial dan Humaniora*, 1(3), 365375.
- Gautam, P. (2021, May 12). Advantages And Disadvantages Of Online Learning. eLearning Industry. <https://elearningindustry.com/advantages->
- Goddard, W., & Melville, S. (2004). *Research methodology: An introduction*. Juta and Company Ltd.
- Haron, H. H., & Arsat, N. (2022, December). Zuckerberg's Metaverse and the Unready Malaysian Laws: Quo Vadis?. In *International Conference on Law and Digitalization (ICLD 2022)* (pp. 123-135). Atlantis Press.
- Hazbar, A. M. H., Alem Mohammed, A., & Karim, A. K. A. (2019). An Empirical Study of Factors Influencing hotel customers' online booking Intention. *مجلة العلوم التربوية و الدراسات الإنسانية*, (5), 1-17.
- Koo, C., Kwon, J., Chung, N., & Kim, J. (2022). Metaverse tourism: conceptual framework and research propositions. *Current Issues in Tourism*, 1-7.
- Krejcie, R. V., & Morgan, D. W. (1970). Determining sample size for research activities. *Educational and psychological measurement*, 30(3), 607-610.
- [learning/ampdisadvantagesonline-learning/amp](https://elearningindustry.com/advantages-and-disadvantages-online-learning/)
- Li, L., Ragavan, N. A., Patwary, A. K., & Baijun, W. (2022). Measuring patients' satisfaction toward health tourism in Malaysia through hospital environment, nutritional advice, and perceived value: A study on Chinese exchange students. *Frontiers in public health*, 10, 893439.

- Li, L., Wu, B., & Patwary, A. K. (2022). How marine tourism promote financial development in sustainable economy: new evidences from South Asia and implications to future tourism students. *Environmental Science and Pollution Research*, 29, 1155-1172.
- Li, L., Wu, B., & Patwary, A. K. (2022). The psychosocial factors affecting chinese Outbound Exchange and mobility students' academic performance during COVID-19. *Frontiers in psychology*, 13, 872516.
- Lin, H., Wan, S., Gan, W., Chen, J., & Chao, H. C. (2022). Metaverse in Education: Vision, Opportunities, and Challenges. *arXiv preprint arXiv:2211.14951*.
- Maswadi, K., Ghani, N. A., & Hamid, S. (2022). Factors influencing the elderly's behavioural intention to use smart home technologies in Saudi Arabia. *Plos one*, 17(8), e0272525.
- Models. *Sustainability*, 14(24), 17037.
- Patwary, A. K., Roy, B., Hoque, R., & Khandakar, M. S. A. (2019). Process of developing a community based tourism and identifying its economic and social impacts: An Empirical study on Cox's Bazar, Bangladesh. *Pakistan Journal of Humanities and Social Sciences*, 7(1), 1-13.
- Pratt, M. K. (2022, November 8). Metaverse pros and cons: Top benefits and challenges. CIO. <https://www.techtargget.com/searchcio/tip/Metaverse-prosandhttps://www.techtargget.com/searchcio/tip/Metaverse-pros-and-cons-Top-benefits-and->
- Sumethokula, P., Patwary, A. K., Srinuanpanc, B., Srinuanpand, C., Suwandee, P., Thammathikulf, A., & Phanong, W. (2020). The potential of new tour repackaging for creative tourism among entrepreneurs in Nakhon Si Thammarat. *International Journal of Innovation, Creativity and Change*, 13(10), 1752-1771.
- The 10 Benefits of Online Learning. (n.d.). School of
- Wang, G., & Shin, C. (2022). Influencing Factors of Usage Intention of Metaverse
- Wu, B., Liu, S., Wang, J., Tahir, S., & Patwary, A. K. (2021). Assessing the mechanism of energy efficiency and energy poverty alleviation based on environmental regulation policy measures. *Environmental Science and Pollution Research*, 28, 40858-40870.
- Wu, B., Zhai, B., Mu, H., Peng, X., Wang, C., & Patwary, A. K. (2021). Evaluating an economic application of renewable generated hydrogen: A way forward for green economic performance and policy measures. *Environmental Science and Pollution Research*, 1-15.

# THE RELATIONSHIP BETWEEN ADAPTIVE CAPACITY AND BUSINESS PERFORMANCE AMONG HOMESTAY OPERATORS IN KELANTAN

NUR HAZIRAH BINTI MOHD FADZIL, NUR IZZATI AQILAH BINTI OSMAN, NUR HAZIKAH BINTI MOKHTAR, NUR ILI IZATI BINTI ISMAIL & FADILAHANIM ARYANI BINTI ABDULLAH

Faculty of Hospitality, Tourism and Wellness, Universiti Malaysia Kelantan  
Corresponding email: [aryani.a@umk.edu.my](mailto:aryani.a@umk.edu.my)

---

## ABSTRACT

In order to sustain business performance among homestay operators in Kelantan, this research study will review the literature on the roles that knowledge capacity, innovation capacity, asset capacity, and digitization capacity play. There will always be a knowledge capacity issue in some aspect of human life. Its capacity for knowledge includes its ability to gather information, create knowledge, disseminate knowledge, and apply knowledge. A person's experience with knowledge capacity can be either positive or negative depending on their personality and social network.

**Keywords: Homestay operators, business performance, capacity**

---

## INTRODUCTION

Kelantan is well known for its alluring natural beauty and diverse cultural heritage. Many visitors from abroad come to Kelantan, and most of those who come here choose to stay at a homestay. The way the environment like the market reacts to the actions of the entrepreneurs determines how well a business performs. To put it another way, a company will succeed if there is a market for the goods or services it provides. Business performance therefore depends on entrepreneurial performance as well as internal factors such as staff reactions to different decisions and external factors changes in consumer relations environment action. Performance as an entrepreneur is different from performance as a business in this approach. An entrepreneur may be operating at a high level, yet unanticipated or uncontrollable factors may lead their business to perform poorly (Delmar, F. 1996).

For instance, a business owner might want to grow but find that doing so would be difficult due to fierce competition or legislative restrictions. It is more reasonable to define entrepreneurial performance as the specific tasks that can or should be controlled because, to put it another way, an entrepreneur can never control all of the aspects driving firm performance. Here, business performance is defined as the capacity for expansion or survival. This is believed to be a clear sign of entrepreneurship. Although survival alone is insufficient as a sign of entrepreneurship, it is a sign of market resilience (Delmar, F. 1996). The importance of business performance is to help you in public relations so people can know who you are, what business you do, and why you do it.

The Malaysian homestays are defined as a place “where tourists stay with the host’s family and experience the everyday way of life of the family in both a direct and indirect manner” (Ministry of Tourism and Culture [MOTAC]) as cited in Ibrahim & Razzaq, 2009. A type of tourism product called homestay offers tourist accommodation services in tourist locations far from the city (Abd Hadi Khan et al., 2022). Villagers have taken the initiative to provide accommodation facilities by hosting tourists in their homes because these tourist spots are located on the outskirts/rural areas and lack

accommodation facilities such as hotels, resorts and chalets. (Shukor et al., 2014). In addition, homestay owners need to be registered with the Ministry of Tourism, Arts, and Culture (MOTAC) to promote their homestays to tourists. However, homestay operators need to have some knowledge of the ins and outs of business. This is to maintain the performance of the homestay business. In Kelantan there are 8 registered homestays based on the January 2023 Statistical Report issued by the Ministry of Tourism, Arts and Culture (MOTAC). The homestays are Homestay Kg Pantai Suri in Tumpat, Homestay Renok Baru in Gua Musang, Homestay Bukit Jering in Jeli, Homestay Kg Batu Papan in Gua Musang, Homestay Kg Kubang Telaga in Bachok, Homestay Seterpa in Kota Bharu, Homestay Kg Jelawang in Dabong and Kemunchup Homestay in Machang.

The capability or capacity of a system, area, or community to adjust to the consequences or impacts of climate change is known as adaptive capacity. An effective way to deal with climatic changes and uncertainties, especially unpredictability and extremes, is to improve one's adaptive capacity. Enhancing adaptive ability decreases vulnerabilities and encourages sustainable growth in this way. (Goklany, 1995).

There are three objectives of this research:

1. To examine the relationship between knowledge capacity and business performance among homestay operators in Kelantan.
2. To examine the relationship between innovation capacity and business performance among homestay operators in Kelantan.
3. To examine the relationship between asset capacity and business performance among homestay operators in Kelantan.

### **Significance of the Study**

The results of this study will also give subsequent researchers an advantage as they work to learn more about how homestay operators' businesses are performing. It also attempts to teach the homestay operators the value of relationships with adaptive capability and commercial performance. According to research and data on this industry's performance among homestay operators, It can and will continue to help the expansion of the tourist sector in our nation.

As a result of this study's findings, homestay operators will also benefit from improved business performance and a greater understanding of the value of homestay tourism. Additionally, it would enable the homestay providers to raise the calibre of their commercial operations.

## **LITERATURE REVIEW**

### **Business performance among operator homestay in Kelantan.**

The evaluation of a business's success in accomplishing its aims and objectives is referred to as business performance. It includes a variety of factors, including as overall growth, market share, customer happiness, operational effectiveness, and financial performance. Here are a few important variables that can affect a company's financial performance. It was significant to bear in mind that business performance could differ between sectors and businesses. Continuously enhancing corporate performance and attaining long-term success depend on consistently tracking key performance indicators (KPIs), carrying out performance assessments, and arriving at data-driven decisions. For the example, factor that can influence business performance among operator homestay in Kelantan is market competitiveness and customer satisfaction.

### **Knowledge capacity**

Knowledge capacity refers to the most significant quantity of knowledge that a person or system can effectively learn, store, process, and use. It stands for the maximum amount of knowledge that a person or organization may acquire and apply. A business operator in the homestay sector can excel in guest pleasure, business operations, and long-term success by building and growing knowledge capacity in these areas. For improving knowledge capacity in this area of study, chances for professional growth, industrial research, and continuous learning are important. Knowledge capacity can be affected by a number of variables, such as cognitive talents, learning capacities, capacity for memory, processing of information skills, and the resources accessible for learning and maintaining knowledge. It is an expanding concept that can grow and extend as the outcome of education, experience, exposure to new ideas, and learning new things. For the example knowledge capacity in business operator homestay were marketing sales and industry knowledge.

### **Innovation capacity**

Innovation capacity was the capacity and willingness to create and implement innovative ideas, procedures, and solutions to improve the homestay business and improve the guest experience are referred to as innovation capacity in the context of a business operator in the homestay industry. In order to encourage and support innovation activities, it is important to cultivate an innovative culture and ensure that the essential tools, techniques, and procedures are in place. A business owner in the homestay sector can differentiate their offerings, improve operational effectiveness, draw in more visitors, and maintain an advantage in an increasingly competitive marketplace by growing their capacity for innovation. It is an ongoing procedure that calls for a drive to learn and a willingness to embracing change and continuous progress.

### **Asset capacity**

When a business operator in the homestay sector discusses assets, asset capacity refers to the tools and financial assets that are at their disposal in order to support operations and offer excellent services to visitors. The effectiveness and competitiveness of the homestay industry are greatly influenced by these resources. Enhancing operations, creating outstanding guest experiences, and establishing long-term success in the homestay business depend on effectively managing and employing these assets.

To increase asset capacity and maintain market competitiveness, it calls for routine maintenance, upgrades, strategic expenses, and the emphasis on continual improvement.

### **Research Hypothesis**

The literature review highlights the independent variable such as knowledge capacity, innovation capacity and asset capacity. According to the literature reviewed, the following is a summary of the study's hypothesis:

#### **H1**

There is a relationship between knowledge capacity and business performance among homestay operators in Kelantan.

#### **H2**

There is a relationship between innovation capacity and business performance among homestay operators in Kelantan.

#### **H3**

There is a relationship between asset capacity and business performance among homestay operators in Kelantan.

### **Research Framework**

The research framework is illustrated as shown in Figure 1 to investigate the relationship between knowledge, innovation and asset. The independent variables are knowledge capacity, innovation capacity and asset capacity. The dependent variable is business performance among homestay operators in Kelantan.

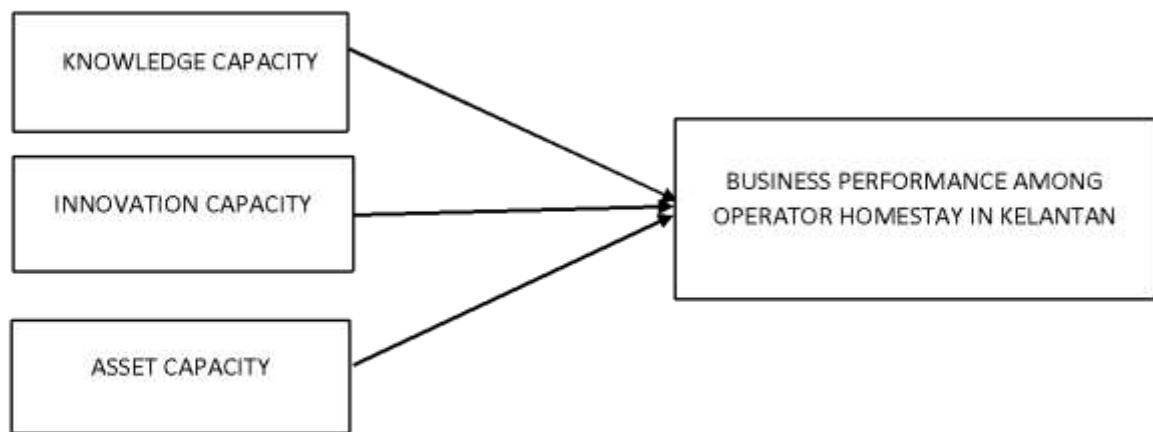

Figure 1: Research framework of adaptive capacity among business performance operators homestay in Kelantan.

## METHODOLOGY

### Research Design

The overall approach you select to integrate the many elements of the study in a cogent and logical manner is referred to as the research design. It will then successfully handle the research challenge. It will also be able to create a plan of action for gathering, measuring, and analysing data. The design of this study is focused on factors influencing the commercial performance of Kelantan's homestay operators. Additionally, data will be gathered from Kelantan's homestay operators using the questionnaire approach. The association between adaptive capacity and business success among homestay operators in Kelantan is closely related to descriptive research on knowledge capacity, innovation capacity, and asset capacity. A descriptive research design makes it simpler to respond to research questions and accomplish research goals. The researchers decided on a quantitative methodology for this investigation. Data collection and analysis must be done quantitatively. Quantitative approaches can be used to prove or disprove any notion.

### Data Collection

This study uses a survey to gather information from respondents about their goals or to obtain firsthand data from homestay operators in Kelantan on the relationship between flexibility and company performance. Primary data can be found in studies, assessments, surveys, and arguments. A set of questions on an evaluation form are intended to collect information from respondents for statistical or research purposes. A survey also used Google Forms and sent to owner homestay in Kelantan via email or Whatsapp group. So this question has be sent using Google Forms via email or Whatsapp groups. A survey made using Google Forms and sent to owner-run homestays all around Kelantan. These questions were created and sent using Google Forms. The respondents' demographic data is provided in Section A. Five Likert scale questions were included in Section B, and Section C. Business performance and adaptive capacity were the main topics of Section C of the study. We asked



the participants about the adaptive capacity and business performance when they were running the homestay in Kelantan. The results of this method might be used to show the connection between Kelantan homestay operators' financial performance and adaptability.

### **Sampling**

Sampling is a method for choosing an adequate number of constituents from a population (Kumar, 2013). A particular subgroup of the population chosen by the researcher serves as the sample subject for the sampling procedure. A selection made using probability and other criteria. There are two different sampling techniques: sampling and random sampling. In this investigation, non-probability sampling was used. Purposive sampling is a sort of non-probability sampling in which researchers choose members of the community to participate in a survey based on their own opinions. It is also referred to as judgmental, selective, or subjective sampling. The sample collected is from operator homestay in Kelantan. The researcher randomly chooses a sample of homestay providers. Any sample of respondents that is easily accessible and convenient for the researcher must be chosen since the sample is available to the researcher. Researchers used sample the study's target population using non-probability and purposeful sampling techniques.

### **Data Analysis**

Data analysis is the act of collecting, modelling, and analysing data to produce insights that can be applied to decision-making. Depending on the industry and the objective of the research, there are numerous methods and strategies for doing analysis. These approaches all have two types of research as their fundamental pillars: quantitative and qualitative research. The researchers used quantitative methods on this study.

## **FINDINGS**

### **Demographic profile of respondents**

According to the results, there were 97 respondents, with 60.8% men and 39.2% women. The majority of respondents are between the ages of 50 and 55 (46.4%), 40 and 45 (38.1%), 60 and older (13.4%), and between the ages of 30 and 35 (2.1%). Regarding race, 100% of the respondents are Malay. This is due to the researcher's observation that other races are more interested in operating resort and hotel businesses than homestay enterprises. The result of demographic profile of respondents has been showed in Table 1.

<b>GENDER</b>	<b>PERCENT</b>
Male	60.8 %

Female	39.2 %
<b>AGE</b>	<b>PERCENT</b>
30 – 35 years old	2.1 %
40 – 45 years old	38.1 %
50 – 55 years old	46.4 %
60 years old and above	13.4 %
<b>RACE</b>	<b>PERCENT</b>
Malay	100 %

Table 1 : Demographic profile of respondents

### **The relationship between adaptive capacity and business performance among homestay operators in Kelantan**

The results of the reliability analysis show that Cronbach's alpha is valid for both the independent and dependent variables. Asset capacity has a Cronbach's alpha score of .873, which is the highest in this investigation. Business performance among homestay operators in Kelantan comes in at .842 and is followed by Knowledge capacity at .804. Innovation capacity had the lowest Cronbach's alpha in this sample, at .732. The results of this analysis's SPSS data demonstrate the significance of both independent and dependent variables. The questionnaire has been acknowledged as valid and approved. Table 2 contains the conclusion of the hypothesis test.

<b>Hypothesis</b>	<b>Pearson's Correlation Results</b>	
H1 : There is a relationship between knowledge capacity and business performance among homestay operators in Kelantan.	(r=1.000 p<0.01)	Strong

H2 : There is a relationship between innovative capacity and business performance among homestay operators in Kelantan.	(r=0.480 p<0.01)	Moderate
H3 : There is a relationship between asset capacity and business performance among homestay operators in Kelantan.	(r=0.470 p<0.01)	Moderate

Note: Significant at  $p < 0.01$ .

Table 2 : Hypothesis testing

Table 2 shows the result of hypothesis testing based on significant value and strength of relationship between variables. The result proves that, all the independent variables are having significant relationship with the dependant variable at ( $p < 0.01$ ). Hence, all the hypotheses were accepted.

## DISCUSSION

This study aims to investigate the connection between business performance and adaptability among Kelantan homestay operators. With a result of  $r = 1.000$ ,  $n = 97$ , and  $p < 0.01$  the findings demonstrate a significant relationship between knowledge capacity and business performance among Kelantan homestay operators. This result were supported by Schober, Boer, & Schwarte (2018) that knowledge capacity are mostly influenced by the push factors to fulfill their desire to gain unique business performance among homestay operators in Kelantan.

With  $r = 0.480$ ,  $n = 97$ , and  $p < 0.01$  for the relationship between inventive capacity and business performance among homestay operators in Kelantan, the results were also moderate. This outcome is consistent with Schober, Boer, and Schwarte's (2018) finding that one factor that can enhance business performance among Kelantan homestay operators is their innovative capacity.

At  $r = 0.470$ ,  $n = 97$ , and  $p < 0.01$  the relationship between asset capacity and business performance among homestay operators in Kelantan is moderate. The conclusion is consistent with Schober, Boer, and Schwarte's (2018) finding that asset capacity can affect homestay operators' business performance in Kelantan.

## CONCLUSION

In summary, this study looked at how business performance among Kelantan homestay operators related to their ability to adapt. The research's conclusions showed that homestay operators with a higher level of adaptability do better in their businesses than those with a lower level of adaptability. The research showed that there are various components that make up adaptive ability, such as gaining knowledge, resource mobilisation, relationship development, and innovation.

## REFERENCES

- Abd Hadi Khan, N. F., Nik Mohd Munir, N. M., Muhamad Nasir, M. N., & Mohd Rasdi, A. L. (2022). A conceptual diagram of Homestay stakeholder's interaction in inducing environmental behaviour. *Journal of Tourism, Hospitality and Culinary Arts*, 14(1), 503-519.
- Akter, M., Sadekin, M. N., & Patwary, A. K. (2020). An Empirical Study on Students' Satisfaction from Mawlana Bhashani Science & Technology University, Bangladesh. *Review of Economics and Development Studies*, 6(2), 363-379.
- Alom, S., Patwary, A. K., & Khan, M. M. H. (2019). Factors affecting the turnover intention of Bangladeshi migrants in the United Arab Emirates: An empirical study on the hotel industry. *International Journal of Innovation, Creativity and Change*, 8(3), 344-360.
- Fengmin, Z., Baijun, W., Jiangtao, B., Li, L., & Patwary, A. K. (2022). Investigating revisit intention of medical tourists in China through nutritional knowledge, perceived medical quality, and trust in the physiologist: A recommendation on health tourism policy measures. *Frontiers in Public Health*, 10, 893497.
- Hazbar, A. M. H., Alem Mohammed, A., & Karim, A. K. A. (2019). An Empirical Study of Factors Influencing hotel customers' online booking Intention. *مجلة العلوم التربوية و الدراسات الإنسانية*, (5), 1-17.
- Inap desa - Wikipedia Bahasa Melayu, ensiklopedia bebas. (n.d.). Inap Desa - Wikipedia Bahasa Melayu, Ensiklopedia Bebas. [https://ms.wikipedia.org/wiki/Inap\\_desa#:~:text=Inap%20desi%20](https://ms.wikipedia.org/wiki/Inap_desa#:~:text=Inap%20desi%20)
- Kepentingan Misi Dan Visi Bisnes. 5 Manfaat Kepada Usahawan - RichWorks. (2021, January 31). RichWorks. <https://richworks.com/kepentingan-misi-dan-visi-bisnes/>
- Learning and the Knowledge Capacity of Organizations | Emerald Insight. (2019, October 24). Learning and the Knowledge Capacity of Organizations | Emerald Insight. <https://www.emerald.com/insight/content/doi/10.1108/978-1-78973-775-220191012/full/html>
- Li, L., Ragavan, N. A., Patwary, A. K., & Baijun, W. (2022). Measuring patients' satisfaction toward health tourism in Malaysia through hospital environment, nutritional advice, and perceived value: A study on Chinese exchange students. *Frontiers in public health*, 10, 893439.
- Li, L., Wu, B., & Patwary, A. K. (2022). How marine tourism promote financial development in sustainable economy: new evidences from South Asia and implications to future tourism students. *Environmental Science and Pollution Research*, 29, 1155-1172.
- Li, L., Wu, B., & Patwary, A. K. (2022). The psychosocial factors affecting chinese Outbound Exchange and mobility students' academic performance during COVID-19. *Frontiers in psychology*, 13, 872516.
- Patwary, A. K., Roy, B., Hoque, R., & Khandakar, M. S. A. (2019). Process of developing a community based tourism and identifying its economic and social impacts: An Empirical study on Cox's Bazar, Bangladesh. *Pakistan Journal of Humanities and Social Sciences*, 7(1), 1-13.
- Pusiran, A. K., & Xiao, H. (2013). Challenges and community development: A case study of homestay in Malaysia. *Asian Social Science*, 9(5), 1. [https://www.researchgate.net/profile/Arif-Pusiran/publication/271338804\\_Challenges\\_and\\_Community\\_Development\\_A\\_Case\\_Study\\_of\\_Homestay\\_in\\_Malaysia/links/5590ee5808ae15962d8c6b5f/Challenges-and-Community-Development-A-Case-Study-of-Homestay-in-Malaysia.pdf](https://www.researchgate.net/profile/Arif-Pusiran/publication/271338804_Challenges_and_Community_Development_A_Case_Study_of_Homestay_in_Malaysia/links/5590ee5808ae15962d8c6b5f/Challenges-and-Community-Development-A-Case-Study-of-Homestay-in-Malaysia.pdf)
- Research Guides: Organizing Academic Research Papers: Types of Research Designs*. (2022, December 8). Types of Research Designs - Organizing Academic Research Papers - Research Guides at Sacred Heart University. <https://library.sacredheart.edu/c.php?g=29803&p=185902>

- Shukor, S., Salleh, N. H. M., Othman, R., & Idris, S. H. M. (2014). Perception of Homestay Operators towards Homestay Development in Malaysia. *Jurnal Pengurusan*, 42. <http://journalarticle.ukm.my/9406/1/9206-25183-1-PB.pdf>
- Sumethokula, P., Patwary, A. K., Srinuanpanc, B., Srinuanpand, C., Suwandee, P., Thammathikul, A., & Phanong, W. (2020). The potential of new tour repackaging for creative tourism among entrepreneurs in Nakhon Si Thammarat. *International Journal of Innovation, Creativity and Change*, 13(10), 1752-1771.
- What is business performance? Definition and examples. (2022, December 9). What Is Business Performance? Definition and Examples. <https://www.primetric.com/blog/business-performance>
- Wu, B., Liu, S., Wang, J., Tahir, S., & Patwary, A. K. (2021). Assessing the mechanism of energy efficiency and energy poverty alleviation based on environmental regulation policy measures. *Environmental Science and Pollution Research*, 28, 40858-40870.
- Wu, B., Zhai, B., Mu, H., Peng, X., Wang, C., & Patwary, A. K. (2021). Evaluating an economic application of renewable generated hydrogen: A way forward for green economic performance and policy measures. *Environmental Science and Pollution Research*, 1-15.

# FACTORS THAT MOTIVATE STUDENT'S WILLINGNESS TO INVOLVE IN VOLUNTEER TOURISM PROGRAMS IN MALAYSIA

\*Puan Raja Norliana Binti Raja Omar, Nur Izzati Husna Binti Mohamad Sobri, Nur Khadijah Binti Abdul Aziz, Nur Masdaliana Binti Rosli, Nur Mawardah Binti Che Husain

*Faculty of Hospitality, Tourism and Wellness, Universiti Malaysia Kelantan  
Corresponding email: [h20a1543@siswa.umk.edu.my](mailto:h20a1543@siswa.umk.edu.my)*

---

## ABSTRACT

This study will look at the motivational variables that contribute to the volunteer tourism program of students in Malaysia. Malaysia does have the ability to attract tourists due to its magnificent natural environment. As a result, the institution and students arrange a variety of activities each year to promote the university as a tourist destination in Malaysia's northern area. Many of these campus activities were made possible by the Department of Student Affairs and thousands of student volunteers. Their contribution is evident and is seen as equally significant as that of full-time employees. Knowing their volunteers' motivational elements and degree of satisfaction allows organizers to plan, execute, and assess their contributions. Many studies have been conducted on the motivating factors, but relatively few have been conducted on volunteers.

**Keywords:** Volunteer Tourism, student volunteers, motivational elements, motivating factors

---

## INTRODUCTION

The purpose of this research is to identify the aspects that motivate students' willingness to take part in volunteer tourism in Malaysia. The researcher explains and clarifies words in this research before summarising the research backdrop, issue statement, research aims, and importance of the study. The theory of this report consists of chapters explaining concepts of motivation, volunteering, and volunteerism.

### Significance of the Study

The importance of a study reflects its impact on the field and its benefits. This study focuses on motivating university students to participate in volunteer tourism in Malaysia. It examines demographics, motivation theories, and the relationship between motivation and student interest in volunteer travel. Factors like self-actualization, social needs, and physiological needs contribute to increased interest in volunteer travel.

## LITERATURE REVIEW

### Self-Actualisation

While Maslow is most generally associated with personal development, the term was coined by Kurt Goldstein. Goldstein defined person-actualization as a comprehensive differentiation, or a way to develop a human being that acts as a primary motivator of activity in humans, in which the person acknowledges that they and their environment are two aspects of a larger entity. (Whitehead, 2017).

In simple terms, self-actualization is the full realisation of one's creative, intellectual, and interpersonal capabilities as a result of one's own intrinsic drive. Because self-actualization concentrates on maximising one's skills in order to reach one's greatest prospective, it is an extremely personalised endeavour that will certainly range significantly from individual to human. This emphasis on individual impulses is important to Maslow's work, and it represents what he feels separates it from current motivational psychology. Self-actualization has additionally been defined as the psychological approach to making the most use of one's talents and resources. This procedure may differ from person to person (Couture et al., 2007).

### Social Needs

Social needs can be described as human basic requirements, known as social needs, demonstrate that they are social beings. Among the most important social wants are those for love, connection, friendship, and a sense of belonging. These demands compel individuals to engage with one another, fostering society and solidarity. These essential requirements must be met in order to have a healthy mind and a pleasant existence. Otherwise, unhappiness and despair take hold and make life miserable.

Abraham Maslow, an American Psychologist, developed the behavioral Hierarchy of Needs, and the desire for feeling loved and included lies on the third stage of the hierarchy. Maslow extends it to friendship, family, and physical relationships. The topics addressed by Social Needs include in communal contexts, social needs encompass at least one of the four bases, which are to communicate, connect, contribute, and create. For example, social needs can be satisfied by addressing one or more of the four C's listed above. Friendship encompasses communicating and connecting, but passionate love encompasses communicating, connecting, and procreating".

## Physiology Needs

Physiological requirements occupy the bottom of Maslow's hierarchy of wants (Maslow 1943, 1970). The physiological needs, or drives, contain all the internal signals that are put in place to urge the organism's immediate protection. Food insecurity, sexuality, and dehydration are examples of physiological necessities. Maslow pointed out that the list of requirements may be broadened to contain even more particular demands, such as a desire for a certain vitamin or mineral, protein content, or cholesterol (Maslow 1943, 1970).

The physiological needs all have a single trait in prevalent: they all assist to preserve the body's normal, normal operation. (Maslow 1943, 1970). The significance of physiological needs having access to food is one of Maslow's hierarchy of requirements. Examples of physiological demands include nourishment. Physiological demands must be satisfied before anyone can think about anything else.

## Willingness to Volunteer

'Motivation to learn,' from a psycho-educational standpoint, has been defined as a student's 'energy and desire to learn, work efficiently, and accomplish to their potential,' as well as the behaviors connected with this energy and drive (Martin, 2004). Kusurkar et al. (2012) acknowledge that the undergraduate curriculum has been mostly influenced by cognitive techniques rather than motivational theories, leading them to the conclusion that desire to study has been undervalued thus far.

According to (Doleel, 2016) in research (Zárubová & vecová, 2021), volunteerism is a broad theme that crosses national, state, and religious boundaries. It continues to be a part of civilization, and its significance is growing all around the world. Volunteers help in catastrophes, wars, and other comparable events. Volunteer duties, together with donation organisations and NGOs that engage with volunteers, are associated with connection with cultural social values and the provision of products and services that are environmentally friendly on a local and global scale, based on (ebestová & Haltofová, 2014).



## Research Hypothesis

**H1:** There is a relationship between self-actualization and factors that motivate student's willingness to be involved in volunteer tourism programs in Malaysia.

**H2:** There is a relationship between social needs and factors that motivate student's willingness to be involved in volunteer tourism programs in Malaysia.

**H3:** There is a relationship between physiological needs and factors that motivate student's willingness to be involved in volunteer tourism programs in Malaysia.

## Research Framework

The researchers have proposed a framework to study the self-actualisation, social needs and physiology needs of willingness to participate in volunteer tourism programmes in Malaysia, based on the previous literature review.

Hence, as seen below, the structure:

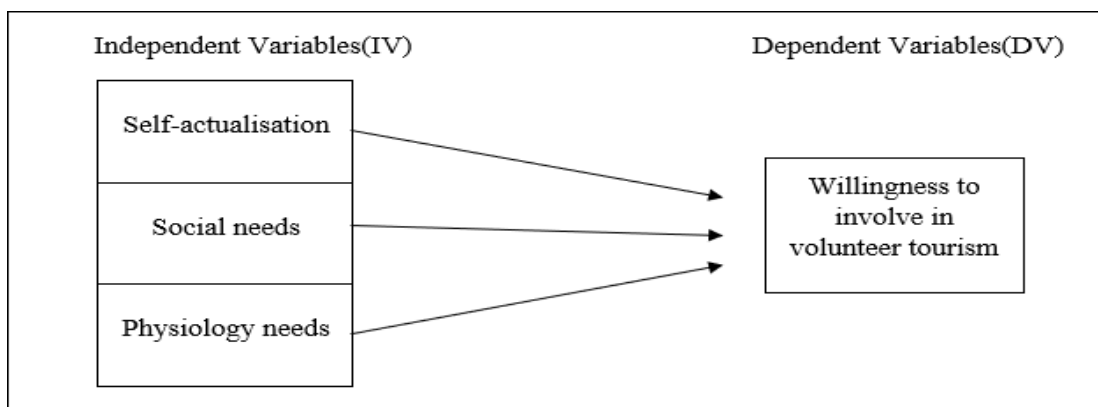

**Figure 1: Conceptual Framework**

## METHODOLOGY

### Research Design

The study structure acts as an outline for a researcher's approaches and tactics. Because of the design, researchers may focus on research approaches that are suited for the topic at hand in order to set up their investigations for success. Investigative studies, descriptive studies, and causal research are the three types of research designs. In design study, gathering information, measuring it, and analysing it may be divided into three areas. As stated by Jahoda, Deutch, and Cook, a research design is the development of settings for the collection and analysis of data in a way that tries to combine the importance of the study's objective with efficiency and approach. Quantitative research design is more flexible and inductive when compared to qualitative research design. This gives us the ability to adjust our strategy in response to what

we learn from the research phase.

## Data Collection

Data collection applies to an efficient method of collecting and analysing details from many sources in order to acquire full and reliable knowledge. This data collection includes sources that are both primary and secondary. Subscribers, members, non-users, or other entities involved in the research. Secondary data is also any information from published sources that was expressly obtained for this study challenge. Data collection methods include questionnaires, Google forms, survey forms, and personal interviews. The survey used for this study was used to collect primary data. For the purpose of gathering data, an application will be given to selected students using Whatsapp and Telegram.

## Sampling

The sampling method used in this paper was the simple sampling. Sample refers to the element of the population. The subject was known as the sample participant and the total number of subjects in the sample is known as the sample size. The researchers chose a relatively small number of students from a cohort of University of Malaysia students using Krejcie and Morgan's table to determine sample size, and there are approximately 150 students from University of Malaysia Kelantan.

## Data Analysis

This part explains the statistical analysis results used in this investigation. Data analysis, according to Edewin Perez (2019), is the technique of completely examining every part of information acquired or given using logical and theoretical principles. The Statistical Package for the Social Sciences (SPSS) investigators examined the data contained on the online survey that was provided to the responders. Academics can use the Statistical Packaging for the Social Sciences (SPSS) tool to swiftly calculate data and do quantitative evaluations. Because of these qualities, this particular piece of software is a particularly renowned statistics system.

## FINDINGS

### Frequency Analysis

Table 1.1 shows the frequency and percentage of respondents by gender. The number of female respondents is 111 with 73.5%, while the number of male respondents is 40 with 26.5%. The percentage of females is higher than the male, and this shows that females are more willing to participate in volunteer tourism.

Table 1.1 Demographic Profile

	Frequency	Percent	Valid Percent	Cumulative Percent
Valid	Female	111	73.5	73.5
	Male	40	26.5	100.0
	Total	151	100.0	

Table 1.2 Age of Respondent

	Frequency	Percent	Valid Percent	Cumulative Percent
Valid	18 years and below	2	1.3	1.3
	19 - 21 years	10	6.6	7.9
	22 - 24 years	127	84.1	92.1
	25 years and above	12	7.9	100.0
	Total	151	100.0	

Based on Table 1.2, the number of respondents aged 18-24 years old is 139 with 92%, while the number of respondents above 25 years old is only 12 with 7.9%. This shows that youths aged 18-24 years old are the main respondents with willingness to participate in volunteer tourism, even once.

Table 1.3 Number of Respondent by Race

		Frequency	Percent	Valid Percent	Cumulative Percent
Valid	Chinese	5	3.3	3.3	3.3
	Indian	6	4.0	4.0	7.3
	Malay	137	90.7	90.7	98.0
	Other	3	2.0	2.0	100.0
	Total	151	100.0	100.0	

Based on Table 1.3, the number of respondents race a total of 151 people who answered the survey, including Chinese is 5 with 3.3%, Indians is 6 with 4.0%, Malay is 137 with 90.7, while the number of respondents for others 3 with 2.0%. This shows that Malay are the main respondents with willingness to participate in volunteer tourism.

Table 1.4 Education Level

		Frequency	Percent	Valid Percent	Cumulative Percent
Valid	Bachelor's Certificates	1	.7	.7	.7
	(Master) Degree	129	85.4	85.4	86.1
	Diploma	12	7.9	7.9	94.0
	Master	2	1.3	1.3	95.4
	SPM	5	3.3	3.3	98.7
	STPM	2	1.3	1.3	100.0
	Total	151	100.0	100.0	

Based on Table 1.4, the number of respondents of education level Bachelor's Certificates Master is 1 with .7%, Degree is 129 with 85.4%, Diploma is 12 with 7.9%, Master is 2 with 1.3%, SPM is 5 with 3.3%, while the number respondents for STPM is 2 with 1.3%. The percentage of Degrees is higher than others, and this shows that education level Degrees are more willing to participate in volunteer tourism.

## Descriptive Analysis Push Factor

Table 1.5: Descriptive Statistics

	N	Minimum	Maximum	Mean	Std. Deviation
IV1	151	1.75	5.00	3.9437	.79013
IV2	151	2.75	5.00	4.2368	.62503
IV3	151	2.50	5.00	4.2732	.61735
DV	151	.67	2.00	.7792	.30765
Valid N (list wise)	151				

The number of respondents, mean, and standard deviation of independent variables were displayed in Table 1.5. Self-actualization came in third at 4.2368, with the means of the independent variables ranging from 3.9437 to 4.2732. The highest mean for the independent factors was physiological needs. 0.7792 was the value of the dependent variable's mean.

Table 1.6: Descriptive statistics of social needs

	N	Minimum	Maximum	Mean	Std. Deviation
My friend who influences my behavior think that I should join volunteer tourism.	151	1	5	3.91	.945
My friends think that I should join volunteer tourism.	151	1	5	3.89	.977
My friends will motivate me to join volunteer tourism.	151	1	5	4.05	.815
Most people surrounding me used to join volunteer tourism.	151	1	5	3.92	1.036
Valid N (list wise)	151				

The mean and standard deviation analysis for the independent variable, social requirements, is displayed in Table 1.6. The survey participants who believed that their friends would support them in going on volunteer trips received the highest mean score 4.05 among all respondents. The reaction was only slightly in favor of their friends' advice that they take part

in volunteer travel, as seen by the lowest mean score of 3.89 (My Friends Think That I Should Join Volunteer Tourism). It was advised that the results for the data set from 151 respondents, where the standard deviation was frequently less than 1, were relatively close to the mean.

Table 1.7: Descriptive statistics of self-actualisation

	N	Minimum	Maximum	Mean	Std. Deviation
By joining more program in volunteer tourism, make me gain more experience.	151	1	5	4.47	.738
Malaysia provide many volunteer tourism program for me to join.	151	1	5	3.99	.883
Students can control their behavior and are motivated to grow and reach their fullest potential because the tourism industry is helping in fulfilling their basic needs.	151	2	5	4.18	.767
By joining more volunteer programs make me get more brainstorming idea and more active.	151	1	5	4.30	.739
Valid N (list wise)	151				

Table 1.7 displays the mean and standard deviation analysis of respondents for the self-actualization independent variable. The respondents thought that taking part in more volunteer travel programs would help them get more experience, as evidenced by the highest mean score of 4.47. The respondent partially agreed that Malaysia offers many volunteer tourism programmes for them to engage as the mean value dropped to 3.99. Standard deviation values for the bulk of the 151 respondents' data were below 1, suggesting that the data were near the mean, whereas standard deviation values over 1 indicated that the data were more scattered.



Table 1.8: Descriptive statistics of physiology needs

	N	Minimum	Maximum	Mean	Std. Deviation
Volunteer tourism program providing assistance such as food, drink, medicine, shelter, and clothing to the needy to reduce unemployment.	151	1	5	4.30	.808
Do you consider yourself suitable to be a volunteer who helps in terms of necessities to people in a country whose economy is failing.	151	1	5	4.13	.819
I joined a volunteer program to help people in need such as food, water and shelter. My religion instructs to help people who are in trouble to continue living.	151	3	5	4.31	.732
The organizers of volunteer tourism program must provide assistance such as food, drink, medicine, and shelter.	151	1	5	4.35	.785
Valid N (list wise)	151				

Table 1.8 showed the mean and standard deviation analysis of respondents on the independent variable which was physiology needs. The respondents' agreement that volunteer tourism programme organisers must provide aid in the form of food, drink, medicine, and shelter resulted in the highest mean value of 4.35. The respondent marginally agreed that they were qualified to serve as a volunteer who provides essentials to citizens of a nation with a failing economy in the lowest mean at 4.13. The majority of the 151 respondents in the data set have standard deviations less than 1, which indicates that their responses were more evenly distributed than the mean.

## Descriptive Analysis Pull Factor

Table 1.9: Descriptive statistics of willingness to involve in volunteer tourism

	N	Minimum	Maximum	Mean	Std. Deviation
Is there a need for anyone to understand the nature of volunteer tourism?	151	2	5	4.79	.656
Does adopting a volunteer tourism mindset increase one's environmental responsibility?	151	2	5	4.73	.757
Do you think volunteering while travelling is enjoyable?	151	2	5	4.84	.578
Valid N (list wise)	151				

Table 1.9 showed the mean and standard deviation analysis of respondents on the dependent variable which was willingness to be involved in volunteer tourism in Malaysia. The respondents who thought that volunteering while travelling was enjoyable had a mean score of 4.84. The respondents' agreement that adopting a volunteer tourist perspective promotes one's environmental responsibilities had the lowest mean, 4.73, of all the responses. The majority of the 151 respondents' data set's standard deviation values fell below 1, indicating values that were close to the mean, while standard deviation values over 1 showed values that were more dispersed.

## Pearson Correlation Coefficient Analysis

One of the crucial tests for determining the linear relationship between the two variables was Pearson's correlation analysis. In this analysis, the dependent variable (willingness to participate in volunteer tourism) and the independent variables (self-actualization, social needs, and physiological needs) were compared to see if there were any relationships. If the relationship is significant, researchers must determine whether the association's strength is appropriate.

Table 1.10: Strength Interval of Correlation Coefficient

Size of Correlation	Interpretation
0.90 to 1.0 (-0.90 to 1.0)	Very high positive (negative) correlation
0.70 to 0.90 (-0.70 to 0.90)	High positive (negative) correlation
0.50 to 0.70 (-0.50 to 0.70)	Moderate positive (negative) correlation
-0.30 to 0.50 (-0.30 to 0.50)	Low positive (negative) correlation
0.00 to 0.30 (-0.00 to -0.30)	Negligible correlation

Source: Abgunbiade and Ogunyika, (2013)

## H<sub>1</sub> : Sosial Needs

Table 1.11: Correlations coefficient for social needs and willingness to involve in volunteer tourism in Malaysia.

		IV1	DV
IV1	Pearson Correlation	1	.136
	Sig. (2-tailed)		.097
	N	151	151
DV	Pearson Correlation	.136	1
	Sig. (2-tailed)	.097	
	N	151	151

Table 1.11 showed the Pearson correlation coefficient, the significant value, and the 151 cases. The p-value was 0.097, below the significant level of 1.0. Self-actualization and willingness to engage in volunteer tourism were related, according to the 0.136 correlation

coefficient.

## H<sub>2</sub> : Self-Actualization

Table 1.12: Correlations coefficient for self-actualisation and willingness to involve in volunteer tourism in Malaysia.

		IV2	DV
IV2	Pearson Correlation	1	.050
	Sig. (2-tailed)		.543
	N	151	151
DV	Pearson Correlation	.050	1
	Sig. (2-tailed)	.543	
	N	151	151

Table 1.12 showed the Pearson correlation coefficient, the significance level, and the 151 respondents. The p-value was 0.543, which was below the 1.0 level of significance. The 0.050 correlation coefficient indicated a weak relationship between self-actualization and willingness to participate in volunteer travel.

## H<sub>3</sub> : Physiological Needs

Table 1.13: Correlations coefficient for physiology needs and willingness to involve in volunteer tourism in Malaysia.

		IV3	DV
IV3	Pearson Correlation	1	.148
	Sig. (2-tailed)		.069
	N	151	151
DV	Pearson Correlation	.148	1
	Sig. (2-tailed)	.069	
	N	151	151

Table 1.13 above illustrated Pearson correlation coefficients, significant value and the number of respondents which is 151. The p-value was 0.069, below the threshold for significance of 1.0. The correlation coefficient of 0.148 indicated a weak relationship between physiological requirements and willingness to participate in volunteer travel.

## **DISCUSSION AND RECOMMENDATION**

The discussions were aimed to solve the questions and address the hypothesis as mentioned in the first chapter of this study. In general, this study has extensively researched the factors that motivate student's willingness to volunteer. Based on findings of the study, there are some recommendations other variables may impact tourism student's willingness to participate in a volunteer program.

Moreover, additional studies on this topic should use qualitative methods instead of quantitative data gathering approaches from respondents. This is because different people have different perspectives of the same object. The methods used in the questionnaire may not correctly reflect the thoughts of the minor respondents. It is advised that future research use interviews to obtain respondent comments regarding tourism students' aspirations to participate in tourism volunteerism. Because of the different techniques used to collect information, the correctness of the outcomes may be improved.

Furthermore, it is advised that subsequent studies extend the amount of study participants outside the University Malaysia Kelantan to include Malaysian states. Given that the target population for hospitality students might be found in a variety of states, expanding the sample size will help to create more precise conclusions.

In addition, the scholar has suggested that Non-Governmental Organisations (NGOs) such as Malaysia Red Crescent, The Buddhist Association, and The Lion Club be permitted to organise activities in universities in order to inspire students to get involved in charitable and green endeavours. Apart from that, the researcher suggests that colleges and universities offer unique or specialised courses on hospitality volunteering in order to enhance exposure and urge hospitality students to get involved in volunteer projects. Also, hosting events at junior high schools would educate youngsters about the ethics of volunteering.

## **CONCLUSION**

In consequence, variables influencing volunteer tourism participation within Malaysia Kelantan City Campus graduates are being researched. The study revealed that mat attitude, social influence, and perceived behavioural control all had a significant impact on university students' understanding of volunteer tourism. According to the statistics, the players influencing volunteer tourism participation are driven by people's eagerness to learn new skills, which could encourage them to favour volunteer tourism over leisure tourism. Another element influencing volunteer tourism is the significant effort made by individuals close to the individual, such as friends or family, to engage in volunteer tourism. Finally, the conclusions of this research might provide a plethora of information for the volunteer tourism sector to raise attention amongst university students about the profits of volunteering.

## REFERENCES

- A definition of volunteer tourism: What is it and where does it fit in the broad tourism industry?* (2020, April 6). Tourism Teacher. Retrieved January 4, 2023, from <https://tourismteacher.com/definition-volunteer-tourism/>
- Akter, M., Sadekin, M. N., & Patwary, A. K. (2020). An Empirical Study on Students' Satisfaction from Mawlana Bhashani Science & Technology University, Bangladesh. *Review of Economics and Development Studies*, 6(2), 363-379.
- Alom, S., Patwary, A. K., & Khan, M. M. H. (2019). Factors affecting the turnover intention of Bangladeshi migrants in the United Arab Emirates: An empirical study on the hotel industry. *International Journal of Innovation, Creativity and Change*, 8(3), 344-360.
- Argadinata, H., & Gunawan, I. (2019, December). The Leadership of Pancasila in Education: Foundation for Strengthening Student Characters in the Industrial Revolution Era 4.0. *Proceedings of the 4th International Conference on Education and Management (COEMA 2019)*. <https://dx.doi.org/10.2991/coe-ma-19.2019.2>
- Blakeley, S. (2021, May 14). *Physiological Needs: Examples | Maslow's Hierarchy of Needs*
- Cherry, K. (2022, November 7). *Motivation: Theories, Examples, Types, and How to Find It*.
- Doležel, J. (2016, July). Catholic Charitable Social Work in the Former Czechoslovakia : With a Focus on the Czech Lands. *European Journal of Mental Health*, 11, 79- 96. <http://dx.doi.org/10.5708/EJMH.11.2016.1-2.5>
- Fengmin, Z., Baijun, W., Jiangtao, B., Li, L., & Patwary, A. K. (2022). Investigating revisit intention of medical tourists in China through nutritional knowledge, perceived medical quality, and trust in the physiologist: A recommendation on health tourism policy measures. *Frontiers in Public Health*, 10, 893497.
- Frick, W. B. (2016, September 15). Remembering Maslow: Reflections on a 1968 Interview.
- Glen, S. (n.d.). *Sample Size in Statistics (How to Find it): Excel, Cochran's Formula, General Tips*. Statistics How To.com. Retrieved January 15, 2023, from <https://www.statisticshowto.com/probability-and-statistics/find-sample-size/>
- Goud, N. (2008, October 1). Abraham Maslow: A Personal Statement. *Journal of Humanistic Psychology*, 48(4). <https://doi.org/10.1177/0022167808320535>
- Hazbar, A. M. H., Alem Mohammed, A., & Karim, A. K. A. (2019). An Empirical Study of Factors Influencing hotel customers' online booking Intention. *مجلة العلوم التربوية و الدراسات الإنسانية*, (5), 1-17.
- Hoffman, E. (2008, October 1). Abraham Maslow: A Biographer's Reflections. *Journal of Humanistic Psychology*, 48(4), 439. <https://doi.org/10.1177/0022167808320534>
- Journal of Humanistic Psychology*, 40(2). <https://doi.org/10.1177/0022167800402003>
- Kusurkar, R. A., Croiset, G., Mann, K. V., Custers, E., & Cate, O. T. (2012, Jun). Have motivation theories guided the development and reform of medical education curricula? A review of the literature. *Academic Medicine*, 87(6), 735-43. <https://doi.org/10.1097/acm.0b013e318253cc0e>
- Li, L., Ragavan, N. A., Patwary, A. K., & Baijun, W. (2022). Measuring patients' satisfaction toward health tourism in Malaysia through hospital environment, nutritional advice, and perceived value: A study on Chinese exchange students. *Frontiers in public health*, 10, 893439.

- Li, L., Wu, B., & Patwary, A. K. (2022). How marine tourism promote financial development in sustainable economy: new evidences from South Asia and implications to future tourism students. *Environmental Science and Pollution Research*, 29, 1155-1172.
- Li, L., Wu, B., & Patwary, A. K. (2022). The psychosocial factors affecting chinese Outbound Exchange and mobility students' academic performance during COVID-19. *Frontiers in psychology*, 13, 872516.
- Lyons, M. (2021, December 15). *Self-Actualization: 6 Ways to Get Started*. BetterUp.
- Maslow, A. H. (2023, January 5). A theory of human motivation. *Psychological Review*, 50(4), 370-396.
- McLeod, S. (2021, December 16). *Hypothesis Definition & Examples*. Simply Psychology. of-needs/ Retrieved January 4, 2023, from <https://www.betterup.com/blog/self-actualization>
- Patwary, A. K., Roy, B., Hoque, R., & Khandakar, M. S. A. (2019). Process of developing a community based tourism and identifying its economic and social impacts: An Empirical study on Cox's Bazar, Bangladesh. *Pakistan Journal of Humanities and Social Sciences*, 7(1), 1-13.
- Šebestová, J., & Haltofová, P. (2014, September). Volunteer Work in the Context of Social Services in the Czech Republic. *Procedia Economics and Finance*, 12(2014), 670-678. [https://doi.org/10.1016/S2212-5671\(14\)00392-X](https://doi.org/10.1016/S2212-5671(14)00392-X)
- Selva, J., & Nash, J. (2017, May 5). *What Is Self-Actualization? Meaning, Theory + Examples*. PositivePsychology.com. Retrieved January 4, 2023, from <https://positivepsychology.com/self-actualization/>
- Social Need - Definition and more | THE-DEFINITION.COM*. (n.d.). Definition | The-definition.com. Retrieved January 5, 2023, from <https://the-definition.com/term/social-need>
- Stainton, H. (2020, April 6). *A definition of volunteer tourism: What is it and where does it fit in the broad tourism industry?* Tourism Teacher. Retrieved January 1, 2023, from <https://tourismteacher.com/definition-volunteer-tourism/>
- Sumethokula, P., Patwary, A. K., Srinuanpanc, B., Srinuanpand, C., Suwandee, P., Thammathikulf, A., & Phanong, W. (2020). The potential of new tour repackaging for creative tourism among entrepreneurs in Nakhon Si Thammarat. *International Journal of Innovation, Creativity and Change*, 13(10), 1752-1771.
- Swaen, B., & George, T. (2022, August 2). *What Is a Conceptual Framework? | Tips & Examples*. Scribbr. Retrieved January 1, 2023, from <https://www.scribbr.com/methodology/conceptual-framework/>
- Team, C. (2022, November 24). *Maslow's Hierarchy of Needs | Overview, Explanation, and Examples*. Corporate Finance Institute. Retrieved January 5, 2023, from <https://corporatefinanceinstitute.com/resources/management/maslows-hierarchy->
- Technology in tourism reshapes the industry*. (2021, March 23). Adamo Software. Retrieved January 16, 2023, from <https://adamosoft.com/blog/technology-in-tourism-reshaping-the-hospitality-industry/>
- The Humanistic Psychologist*, 45(1), 71-83. Video & Lesson Transcript. Study.com. Retrieved January 5, 2023, from <https://study.com/learn/lesson/psychologic-al-needs-examples-maslow.html>
- Thomas, S. (2015, August 31). *What Are Social Needs in Maslow's Hierarchy? - Definition & Examples - Video & Lesson Transcript*. Study.com. Retrieved January 4, 2023, from



<https://study.com/academy/lesson/what-are-social-need-maslows-hierarchy-definition-examples-quiz.html>

s- in-

Verywell Mind. Retrieved January 4, 2023, from <https://www.verywellmind.com/what-is-motivation-2795378>

Whitehead, M. P. (2023, January 5). Goldstein's self-actualization: A biosemiotic view.

Wu, B., Liu, S., Wang, J., Tahir, S., & Patwary, A. K. (2021). Assessing the mechanism of energy efficiency and energy poverty alleviation based on environmental regulation policy measures. *Environmental Science and Pollution Research*, 28, 40858-40870.

Wu, B., Zhai, B., Mu, H., Peng, X., Wang, C., & Patwary, A. K. (2021). Evaluating an economic application of renewable generated hydrogen: A way forward for green economic performance and policy measures. *Environmental Science and Pollution Research*, 1-15.

# THE EFFECT OF INTERPERSONAL SKILLS ATTRIBUTES TOWARDS MOTIVATION TO VOLUNTEER AMONG YOUTH IN KELANTAN

Nur Najah Fatimah Bt Khairul Anuar(H20A1549)

Nur Nazirah Binti Azizan (H20A1553)

Nur Onie Izzatul Binti Mahamud (H20A1554)

Nur Saufinah Binti Abd Rahman (H20A1559)

\*Puan Raja Norliana Binti Raja Omar\*

*Faculty of Hospitality, Tourism and Wellness, Universiti Malaysia Kelantan*

*Corresponding email:*

---

## ABSTRACT

It has come to everyone's attention that volunteering is an excellent way for students to get educational and culture experiences while also assisting to community in with they are staying. Because volunteers play such a significant role in the tourist business, participating in volunteer work within the industry is an essential part of the education process for the tourism sector. Due to the fact that volunteering is an educational activity, the objective of this research is to investigate the influence of adolescents' interpersonal skills traits on the activities they participate in as volunteers in the state of Kelantan in Malaysia. Teamwork, non-verbal communication, and building relationship have all been utilized as variables in this study to examine the usefulness of these interpersonal skills traits in inspiring teens to participate in volunteer work. The survey via Google Form was administered to a target audience of 260 adolescents from the surrounding of Kelantan.

**Keywords:** *Volunteerism, Team Working, Negotiation, Non-Verbal Communication, Building Relationship*

---

## INTRODUCTION

Over the years, there seems to be some pedagogical argument and public dispute about the acknowledgment of different forms of tourism, such as ecotourism, sustainable tourism, and responsible tourism (Smith & Font 2014). Volunteer tourism is one of the quickest developing kinds of alternative tourism, and it has been recognized as a beneficial combination of assistance to the host community while simultaneously providing cultural and educational advantages for students (Molz,2016) (sin 2009; McGehee 2014). Furthermore, many agencies such as Global Vision International (GVI) and Love Volunteer at Global Level, in context at Malaysia the agencies that involved is SOLS 24/7, WWF Malaysia, and UNICEF Malaysia have dispatched volunteer tourists from around the country and provide the opportunity for students to learn and develop and experience people in the industry of tourism to attract foreign travelers.

Interpersonal skills are abilities that must be used in everyday life to engage and communicate with others, whether alone or in groups. Interpersonal skills have been referred to as social skills, social competence, human skills, human talents, and social intelligence, according to previous studies. “Skills essential for individuals to communicate effectively with each other or a community of individuals,” according to Rungapadiachy, (1999).

Next, interpersonal skills, on the other hand, refers to a collection of abilities that includes interactive conversations, connections, and a collaborative way of managing connections in terms and inside organizations, along with networking with individuals from various communities and different expertise (Malaysia Qualification Framework, 2017). Nonverbal communication, listening skills, conveying information, negotiating, collaborating, decision making, team working, networking, relationship building, assertiveness, respect, tolerance, socializing with skills and etiquette, self-awareness, and ethical responsibility are 216 characteristics (Malaysia Qualification Framework, 2017) that can be used in interpersonal skills.

Volunteering in the tourism industry is also an important element of the tourism education process. According to Kim & Cuskelly (2017), because volunteerism are so vital in the tourism industry, there has been a lot of studies on volunteerism in the tourism market from throughout the world, for example 21 Century Volunteering Practices, Report: Volunteerism and Youth Employment in Cambodia and Volunteering Typologies (UN Volunteers website <https://www.unv.org/publication/research-volunteerism?page=0> last accessed 04/01/2022). Volunteering is a concept that originated in Western countries, and the vast bulk of current study on the subject is conducted by Western academics in developed economies, according to Baillie Smith, Laurie, & Griffiths, (2018). Given the scarcity of research on the subject and China’s growing importance in the global tourism industry, volunteerism in tourism should be looked into further. Tourism volunteering, according to Uriely, Reichel, & Ron, (2003), should extend beyond volunteer travelers to include hosts who work in the local tourism industry.

Motivation in volunteering as a multidimensional phenomenon consists of two categories of motivations: self-interest and altruistic motivation, according to (Mustonen, 2007; Stebbins, 1992, 2004; wearing,2001). has significance self-interest is a wide phrase that encompasses a variety of components of motivations that focus around the participants' self - 34 interest, whereas altruistic motivation entails other advantages. This altruistic motivation can be described in a variety of ways and different forms. It's the same as "making a change" (Brown,2005; lo & Lee, 2011). All of these are reflective of earlier researchers' altruistic motivations.

Motivation in volunteerism as a multidimensional phenomenon consists of two categories of motivations: self-interest and altruistic motivation, according to (Mustonen, 2007; Stebbins, 1992,2004; Wearing, 2001). Has significance self-interest is a wide phrase that encompasses a variety of components of motivation that focus around the participants' self-interest, whereas altruistic motivation entails other advantages. This altruistic motivation can be described in a variety of ways and different forms. It's the same as " making a change"

(Brown,2005;Lo & Lee, 2011). All of these are reflective of earlier researchers' altruistic motivations.

## **PROBLEM STATEMENT**

Volunteering has traditionally been seen as a "human manifestation of helping" (Clary EG, Snyder M and Ridge RD, 1998), a pro-social activity in which time is given voluntarily for the purpose of helping others without monetary compensation (Wilson, 2000). ). Penner, 2004). The fact that both the person helping others and the person being helped can benefit in this way can also be described as a win-win concept. But this benefit is not only in terms of helping others with their financial needs, but also in terms of helping with personal emotional problems, daily needs, and physical assistance. In addition, the most important aspect of involvement in volunteer activities should be the fact that the nature of personal interpersonal skills will be greatly enhanced.

The fact that the interpersonal skills of youth can be improved is an educational alternative. However, it is not easy for young people to understand how volunteers feel and the mood they understand during volunteering activities. Therefore, the youth group should be more involved in social volunteering activities. In addition, Bianca & Ronelle (2018) stated that volunteering is a platform where youth can learn to serve (that is, be exposed to community issues and identify solutions to solve them) and serve to learn (that is, acquire interpersonal traits and skills ./soft skills attributes, along with other aspects).

Youth volunteering in this way can emphasize the possibility for active learning and service, as well as the possibility to gain practical experience and develop interpersonal skills while learning about the people and issues the volunteer supports.

Interpersonal skills can be defined as "the skills needed to communicate effectively with other people or groups of people" (Rungapadiachy, 1999). In other words, this clearly shows that interpersonal skills lead to the ability to express oneself fluently with others. Interpersonal skills are often needed by people entering society, especially the youth group. It is even more important for the youth group to increase the necessary interpersonal skills including their attributes for their future. According to the findings of Albina (2017), many youth improve their interpersonal skills to develop skills related to their future careers and from their volunteering experiences. This researcher believes that volunteering is like a professional activity and can be integrated into the learning process of youth, which can make the whole experience more positive and enjoyable for youth.

Furthermore, the Australian Qualifications Framework (AQF) has set some of these attributes for different qualification levels since 2011. These include teamwork skills, which will be included in the AQF at all levels of education (AQF, 2016; Fraser & Thomas, 2013). Teamwork is about working together with different people to complete a job or activity. In volunteering activities, it is inevitable that you may meet people with opposing views while helping. A study conducted by Goh and Lee in 2018 showed that students are also afraid of working with teams in their future jobs because of the pressure that will be caused by people working together. However, volunteer activities combine with the pressures and tensions that exist between different age groups and between people from different sectors to ease their rusty understanding. This disagreement and disharmony can be explained by the fact that there is usually less involvement in large teams. It is easier to complete any challenging task when teamwork is perfect.

Negotiation is an efficient communication technique in human interaction. Some people believe that negotiation skills are learned at an early age, but this is not the reality; Good negotiation requires training and practice for the majority of individuals (Shell, 2000; Thompson, 1991). Volunteering improves negotiation skills because volunteers engage with a variety of individuals, including stubborn people, people who do not listen to advice, people with rebellious beliefs, and others. As a result, when the youth is gifted with someone who is deliberately tough, his negotiation skills will be

stimulated to help them effectively. In other words, the volunteer can use his negotiation skills to persuade others who make unreasonable demands to comply with the plan. Furthermore, experience of volunteer negotiation skills may have a confidence-boosting effect. As a result, negotiation skills can influence the success of an event and maintain relationships between negotiators on both sides

Next, just because a volunteer doesn't offer a cash reward doesn't mean that the volunteer doesn't satisfy the volunteer. Volunteers seek to learn new knowledge, meet new friends, use their abilities, and gain a sense of self-worth by participating in volunteer activities. The most obvious benefit of volunteering is that it improves personal non-verbal communication abilities as well as personal communication skills. Non-verbal communication skills aim to enable students to understand non-verbal communication when they cannot always 'read' the non-verbal behavior of others (Patterson & Berg, 2014). Non-verbal communication usually requires practice and direct conversation. While much coursework allows students to explore nonverbal communication, service learning provides a very rich channel for students to recognize, evaluate, and investigate non-verbal communication in interpersonal situations (Patterson & Berg, 2014).

Volunteering for learning not only aims to prepare youth for social engagement and interaction across a large population, but either leads to higher achievement in today's diverse modern workplace (Levesque-Bristol, Knapp, & Fischer, 2010; Littlefield, 2006). ). Non-verbal communication skills are important because people in need may use these skills to ask for help from volunteers. They will usually act subconsciously, such as with body movements, facial expressions, and speaking in a tone that helps to convey the meaning of the language. This is because non-verbal communication skills are subtle cues that are often overlooked by volunteers and result in the best time to help others being missed.

In addition, the most likely nature of personal interpersonal skills that can be explored in volunteering is the building of relationships between people. Building relationships is based on getting to know each other and building relationships in a friendly way. On the other hand, relationships are not defined and developed to support their activities through trust between individuals. Although the volunteer presence is not permanent, they believe in building relationships in the community because of their volunteer activities. Therefore, volunteer activities build relationships with the community more than building activities, because building relationships with the community is more valuable

and educational for the volunteer. Much of volunteering abroad is about building relationships, which is a two-way process and suggests that volunteers take advantage of opportunities to learn differences from other cultures (Comhl amh, 2011). This is one of the key interpersonal skills that volunteers feel should be included in volunteering activities when it comes to building relationships.

Finally, altruism is defined as a long-term and organized effort for the benefit of others, for example, formal volunteering. Although the individual responsible for altruism may profit indirectly from it, he feels a sense of accomplishment in doing good for others. However, not every voluntary act is an act of altruism, and not every act of altruism is a voluntary act; however, the two notions are so closely related that one cannot be asserted without the other (Haski-Leventhal, 2009). Therefore, altruism is a win-win concept in volunteering before it inspires most individuals, especially the youth, to want to be involved in the activity. Because of their experience in education, they will want to do something beneficial, and volunteering will be their first choice. Youth volunteers will see the meaningful event as their contribution to society, and in return, they may gain a sense of satisfaction from their service, including interpersonal skills.

## **SIGNIFICANCE OF THE STUDY**

There are many studies related to volunteerism that have been discussed by other researchers, but the relevant content depends on benefits, disadvantages, effects, consequences or others. While interpersonal skill attributes have not been done for now or the lack of research focuses on this context. Based on this study, youth and community know the usefulness of volunteering not only to help others but also to improve and develop their interpersonal skills. Interpersonal skills are valued nowadays because people are considered important whether in a position as a student, employee, or unemployed. The reason is that interpersonal skills can be communication skills, attitudes, and kindness as a social being. Furthermore, the attributes of interpersonal skills are not something acquired through study, but they require people to be involved and understand the lives of others. The attributes of interpersonal skills learned in volunteering help improve one's ability and attitude to do something. This study is about understanding whether Malaysians can improve and develop interpersonal skills while volunteering. In addition, conducting this study will be an important resource for future researchers, including students from other institutions as well as relevant government departments. For future researchers, this may only be an analysis for youth in volunteering. Instead, investigators need to learn more about the nature of interpersonal skills that can be developed in volunteering and understand the perceptions of other professions. Future

investigators can use this study to compare with future research, allowing future researchers to see whether volunteering has made a difference to Malaysians or individuals in the community and whether their interpersonal skills issues have improved (Developing interpersonal skills: a micro-skills approach, 2002).

## **LITERATURE REVIEW**

### **Research Hypothesis**

A hypothesis is a specific, verifiable description of what the researcher(s) expects to happen in the study (plural: hypotheses). It is announced at the start of the research. In most cases, this entails speculating on a possible correlation between two variables: the independent variable (what the researcher modifies) and the dependent variable (what the research measures). The null hypothesis and the alternative hypothesis are two variants of the hypothesis that are frequently used in research (called the experimental hypothesis when the method of investigation is an experiment). A theory must be able to be tested against reality and either confirmed or disproved. Before conducting the test, the researcher makes the initial assumption that there is no difference between the populations from which they are drawn. The null hypothesis is understood to be this. The alternative hypothesis is another name for the research hypothesis. (McLeod, 2021)

### **H1 – There is a relationship between negotiation and volunteer among youth**

Joining a team is a simple way to improve your teamwork skills. In school and education, there are numerous opportunities to do so. In-class projects can be completed in groups or pairs. You can become a member of a sports team. You can organize a school-wide charity event and solicit donations and support from your friends and family. The development of a hypothesis between teamwork and motivation among youth benefits the youth by giving them confidence in contributing ideas to voluntary project initiatives. Furthermore, the youth can contribute to the project by providing energy and a positive attitude.

### **H2 – Existence of teamwork and motivation to volunteer among youth**

Negotiation is a process or interaction aimed at reaching a mutually beneficial agreement while maximizing individual benefits. The results have an impact on all or some of the parties involved. By definition, negotiation is critical reach consensus decisions that provide satisfaction and justice to all parties involved. In negotiations, it is also necessary to control emotions and feelings, as well as understand each other's roles. Hypothetical development to negotiate and motivate youth to volunteer is likely to form high and positive interpersonal skills towards themselves. Negotiation and motivation to volunteer becomes an indicator of a volunteer's personality when they are fully committed.



**H3 – There is a relationship between negotiation and motivation to volunteer among youth**

Building relationships is about our ability to recognize and initiate working relationships that benefit ourselves and others. Positive relationships are essential to getting things done well and achieving success. By definition, a good relationship is very important in benefiting each other's lives. Develop positive relationships with everyone, not just family, friends or co-workers. As a result, developing hypotheses in building relationships and motivation to volunteer is important for his group to achieve high interpersonal skills. Building relationships and interpersonal skills can help them deal with others more comfortably and cordially. They may be able to form a harmonious relationship as well.

**H4 – There is a relationship between relationship building and motivation to volunteer among youth**

**Research Framework**

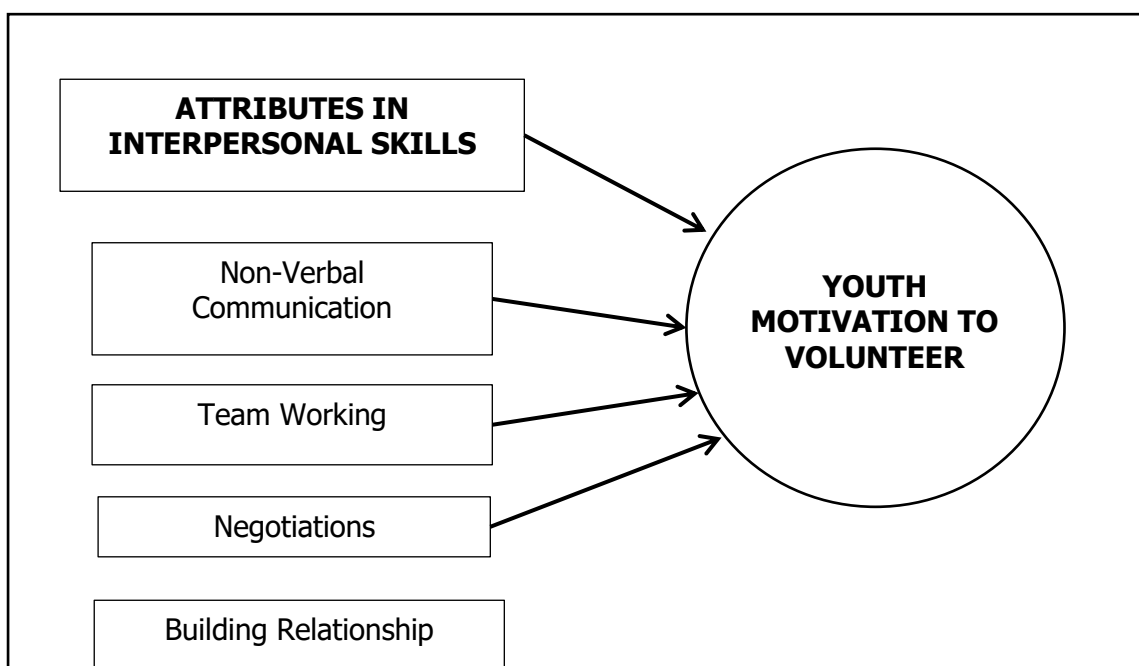

Figure 1: Conceptual of Framework the Youth

Source: Malaysian Qualification Framework,2017

By referring to the literature review, a research framework has been proposed to investigate the relationship between the effect of interpersonal skills attributes and motivation on Volunteering among youth in Kelantan . The proposed conceptual framework is illustrated in Figure 2.4. Proposed independent variables include interpersonal skills attributes of nonverbal communication, teamwork,

negotiation, and relationship building. The dependent variable is the youth's motivation in volunteering.

The researcher found a correlation between the motivation of young people to participate in volunteering activities and the attributes of interpersonal skills. The researcher concludes that any skills that can benefit students during volunteering ATTRIBUTES IN INTERPERSONAL SKILLS Non-Verbal Communication Team Working Youth Motivation To Volunteer Negotiations Building relationship activities can be used as motivation to make undergraduate students participate in volunteering activities. Furthermore, the nature of these interpersonal skills acts as a stimulus to both university students and volunteers for them to have a better version of themselves and be able to live a smoother working life in the future. Although there are many types of interpersonal skills attributes, this study will focus on non-verbal communication, teamwork, negotiation skills, and relationship building (Aqf.edu.au, 2013). However, these interpersonal skills can indirectly influence the motivation of youth in participating in volunteering activities.

## **METHODOLOGY**

### **Research Design**

This study design is a broad framework that might accommodate all of the aspects of a research study. Earlier studies have characterized the design of this study as a collection of conditions for data collecting and analysis in a way that tries to combine data and information, according to Jahoda, Deutch, and Cook (1965). This study was designed in a variety of ways, including qualitative, quantitative, and mixed research. In this study, the researchers have decided to employ quantitative research design to collect and analyze data in this study. The selection of study design approach, quantitative research, characterized be characterized as an analysis for a problem that is investigated and through collecting of quantifiable data and data analysis utilizing mathematical methodologies. According to Leedy & Ormrod (2001), and Williams (2011), quantitative research began with the formulation of a problem, the generation of hypotheses, the literature review, and the analysis of quantitative data that use inquiry strategies and data collection instruments designed to produce statistical data. research. The use of survey questionnaires that is an inter-field study to help researchers collect data from the group or population to be examined and queried is one of the research designs used by researchers to acquire data.

## **Data Collection**

Data collection is explained as the process of collecting and measuring information about variables in a predetermined and systematic way that allows respondents to answer predetermined research questions, test hypotheses, and predict future trends (Kabir, 2016). Some of the data collection is universal for all research sectors, including commercial, physical, social and humanitarian. The goal of all data collection is to produce high-quality evidence, which can then be translated into comprehensive data analysis and used to provide reasonable answers to stated questions. Regardless of how the field of research or preference defines data (quantitative, qualitative), reliable data collection is essential to the integrity of the study

This research will be conducted using an online questionnaire constructed by providing a Google Form as a distribution method. The researcher will share the Google form to various social media platforms such as Whatsapp, Facebook and Telegram to be able to collect feedback from respondents. Respondents for this research were collected from among all the youth in Kelantan. Therefore, the researcher will show and explain to the respondents how to answer this questionnaire. The questions in this questionnaire raise some concerns regarding the notion of the relationship between motivation to volunteer and interpersonal skills among youth in Kelantan. However, a 6-point Likert scale will be used to evaluate the data collected.

## **Sampling**

In this study, the researcher chose the sampling method in this study to facilitate data collection. The sampling method used in this study is critical. This is due to the fact that it is a procedure to select a sufficient number of policies from the population (Kumar, 2013). During the sampling phase, the researcher selects individuals from the general public to be used as subjects of the sample population. Furthermore, there are two types of sampling methods: probability sample and non-probability sample.

Quantitative research is synonymous with probability sampling methods. This method is used randomly when the sample contains characteristics from the study population. Therefore, before performing the probability sampling procedure, the researcher should determine the size of the population and obtain a list of subjects in the population. Non-probability sampling, also known as non random sampling, is a type of non-random sampling commonly used in qualitative research.

Although non-probability sampling methods are samples collected in a process such that each element of the population has no known chance of being selected. The degree of bias in selecting the sample is unknown.

In this study, the researcher used probability sampling to conduct this research. This is due to the fact that probability sampling is a technique where the researcher uses the method of probability theory to select a sample from a larger population. A random sample is one drawn from a method used when the entire population is available and the researcher has a list of the target population. The sample frame is a list obtained from the subjects in this population. Based on the findings of this study, the sample was taken from the effect of interpersonal skill characteristics on the motivation of youth volunteers in Kelantan

### **Data Analysis**

Data analysis is the process of using a statistical or logical approach to describe, summarize, and evaluate data. Some data analysis tools, according to Shamo and Resnik (2009), allow researchers to derive inductive conclusions from data by distinguishing between "phenomena of interest" and "statistical fluctuations" in the data. Data analysis is the process of obtaining, modeling and analyzing data to obtain insights that can be used to make decisions. Analytical

approaches in any study are mostly focused on two areas, namely quantitative and qualitative methods.

In addition, primary data and secondary data are types of data analysis. Primary data is defined as the researcher collecting data through surveys, interviews, or experiments for specific research purposes. Secondary data means collected only by collecting it from previously released information. In this study, the primary data obtained by the researcher was collected from a questionnaire. Meanwhile, secondary data is collected from journals, newspapers, and websites.

In addition, the researcher examined statistical data analysis using SPSS, known as Statistical Analysis for Social Sciences, version in this research. It is a window based program that allows you to create tables and pie charts for data entry and analysis (Magrizos, Kostopoulos and Powers, 2020).

In this study, the researcher collected data for data analysis and conducted descriptive statistical analysis, reliability test analysis, and Pearson correlation analysis.

## **DISCUSSION AND RECOMMENDATION**

Most of the participants in this programme are college students between the ages of 21 and 23. Furthermore, volunteering has a lot of positive effects on both mental and physical health. Stress, rage, and anxiety are treated with the assistance of volunteers. Helping and working together with others is a social relationship quality among Kelantan's young. Through this volunteer programme, young people can also acquire practical experience and develop crucial skills like leadership, problem-solving, and time management. Students between the ages of 21 and 23 make up the majority of participants in this programme. Furthermore, volunteering has numerous advantages for both mental and physical health. Stress, rage, and anxiety are among conditions that volunteers aid in treating. Helping and working together with others is a component of social relationships among young people in Kelantan. By participating in this volunteer programme, young people can also develop crucial skills like leadership, problem-solving, and time management. There are various benefits of volunteering for both mental and physical health. Young people who take part in the volunteer programme can benefit from the assistance of volunteers in overcoming the negative consequences of stress, rage, and anxiety. Helping others is also regarded as one of the ways people create, preserve, and deepen social bonds between young people and others. We can develop a sense of community, meet new people, and feel a sense of belonging through volunteering and assisting others, for instance.

This research findings may be useful for a variety of vocations, particularly for university students who are interested in learning more about the causes and impact of volunteerism. In order to further enhance the investigations outcomes, there are also some suggestions for future studies. Four interpersonal skills which is non verbal communication, teamwork, negotiation and relationship development describe in this research are not the only ones that apply to volunteering. This is because everyone has a different personalities, their interactions with one another will totally be different. Therefore, getting along may require more than these four attributes such as the ability to listen, make decisions, show respect for others, be tolerant, be self aware, be ethically responsible or many other attributes.

Future research may also take into account a number of additional elements that are crucial for examining its efficacy. In addition, several ideologies may be examined in future research to uncover additional factors that affect university students willingness to volunteer. In conclusion, employing questionnaires as the only quantitative way to gather study results may only yield disappointing outcomes. Therefore, additional research techniques, such as qualitative ones, may be added in the future to produce more reliable results.

## CONCLUSION

This study aims to ascertain the proportion of youth in Kelantan enthusiastic about volunteer programmes as well as the effects of volunteering on youth. Youth who participated in this volunteer programme can gain new experiences and learn more about volunteering while also developing their social skills and public speaking abilities. In conclusion, the public are greatly impacted by volunteering programme since it can increase their knowledge and provide them to be more confidence to interact with the public. The goal of this volunteerism project is to educate people especially the youth about the value of volunteering and its advantage for them personally.

## REFERENCES

- A. (2017, August 1). Kemahiran Berunding. PORTAL MyHEALTH. <http://www.myhealth.gov.my/kemahiran-berunding-2/>
- Akter, M., Sadekin, M. N., & Patwary, A. K. (2020). An Empirical Study on Students' Satisfaction from Mawlana Bhashani Science & Technology University, Bangladesh. *Review of Economics and Development Studies*, 6(2), 363-379.
- Al, U. H. (2019). Factor that influencing behavioural toward voluntourism. *International Journal of e-Navigation and Maritime Economy*, 032–041. Australian Qualifications Framework, Australian Government. (2013, January). Australian Qualifications Framework. <https://www.aqf.edu.au/>
- Alom, S., Patwary, A. K., & Khan, M. M. H. (2019). Factors affecting the turnover intention of Bangladeshi migrants in the United Arab Emirates: An empirical study on the hotel industry. *International Journal of Innovation, Creativity and Change*, 8(3), 344-360.
- Amh, C. (2011). International Volunteer: Working with Children. Volunteeringoptions.Org. <https://www.volunteeringoptions.org/>
- Bhandari, P. (2021, December 13). An introduction to descriptive statistics. Scribbr. <https://www.scribbr.com/statistics/descriptive-statistics/>

- Carrell, L. J., & Willmington, S. C. (1998). The relationship between self-report measures of communication apprehension and trained observers' ratings of communication competence. *Communication Reports*, 11(1), 87–95. <https://doi.org/10.1080/08934219809367688>
- Fengmin, Z., Baijun, W., Jiangtao, B., Li, L., & Patwary, A. K. (2022). Investigating revisit intention of medical tourists in China through nutritional knowledge, perceived medical quality, and trust in the physiologist: A recommendation on health tourism policy measures. *Frontiers in Public Health*, 10, 893497.
- Hazbar, A. M. H., Alem Mohammed, A., & Karim, A. K. A. (2019). An Empirical Study of Factors Influencing hotel customers' online booking Intention. *مجلة العلوم التربوية و الدراسات الإنسانية*, (5), 1-17.
- Li, L., Ragavan, N. A., Patwary, A. K., & Baijun, W. (2022). Measuring patients' satisfaction toward health tourism in Malaysia through hospital environment, nutritional advice, and perceived value: A study on Chinese exchange students. *Frontiers in public health*, 10, 893439.
- Li, L., Wu, B., & Patwary, A. K. (2022). How marine tourism promote financial development in sustainable economy: new evidences from South Asia and implications to future tourism students. *Environmental Science and Pollution Research*, 29, 1155-1172.
- Li, L., Wu, B., & Patwary, A. K. (2022). The psychosocial factors affecting chinese Outbound Exchange and mobility students' academic performance during COVID-19. *Frontiers in psychology*, 13, 872516.
- Patwary, A. K., Roy, B., Hoque, R., & Khandakar, M. S. A. (2019). Process of developing a community based tourism and identifying its economic and social impacts: An Empirical study on Cox's Bazar, Bangladesh. *Pakistan Journal of Humanities and Social Sciences*, 7(1), 1-13.
- Populations and samples | The BMJ. (2020, October 28). The BMJ | The BMJ: Leading General Medical Journal. Research. Education. Comment. <https://www.bmj.com/about-bmj/resources-readers/publications/statistics-square-one/3-populations-and-samples>
- Sumethokula, P., Patwary, A. K., Srinuanpanc, B., Srinuanpand, C., Suwandee, P., Thammathikul, A., & Phanong, W. (2020). The potential of new tour repackaging for creative tourism among entrepreneurs in Nakhon Si Thammarat. *International Journal of Innovation, Creativity and Change*, 13(10), 1752-1771.
- Wu, B., Liu, S., Wang, J., Tahir, S., & Patwary, A. K. (2021). Assessing the mechanism of energy efficiency and energy poverty alleviation based on environmental regulation policy measures. *Environmental Science and Pollution Research*, 28, 40858-40870.
- Wu, B., Zhai, B., Mu, H., Peng, X., Wang, C., & Patwary, A. K. (2021). Evaluating an economic application of renewable generated hydrogen: A way forward for green economic performance and policy measures. *Environmental Science and Pollution Research*, 1-15.

# Understanding Success Factor Strengthen Min House Camp As A Community-Based Tourism Product In Kelantan During Post-Covid

Nur Shafikah Binti Isehak, Nur Shahirah Binti Rosli, Nur Shazana Binti Shahrom, Nur Syafikah Nabila Binti Abdul Mutalib, \*Raja Norliana Binti Raja Omar

*Faculty of Hospitality, Tourism and Wellness, Universiti Malaysia Kelantan*

*Corresponding email: [h20a1560@siswa.umk.edu.my](mailto:h20a1560@siswa.umk.edu.my), [h20a1562@siswa.umk.edu.my](mailto:h20a1562@siswa.umk.edu.my), [h20a1566@siswa.umk.edu.my](mailto:h20a1566@siswa.umk.edu.my), [h20a1569@siswa.umk.edu.my](mailto:h20a1569@siswa.umk.edu.my)*

---

## ABSTRACT

This study aims to achieve the goal and investigate the possibility of significant success in community-based tourism in Min House Camp, Kubang Kerian, Kelantan. There are four factors stated in the study showing the success that strengthens community-based tourism in Min House Camp, namely leadership, tourism management, community participation and tourism networks. This study also uses quantitative methodology. The collected data were obtained through a questionnaire distributed to 296 respondents. The study was conducted via survey research, together with participant and non-participant observations during Min House Camp tourism-related events.

**Keywords:** Leadership, Tourism Management, Community Participation, Tourism Network, Community-Based Tourism, Min House Camp

---

## INTRODUCTION

The proposes to understanding success factors that strengthen Min House Camp as a community-based tourism product in Kelantan during post-covid be discussed in the introduction to this chapter. This chapter 1 will begin to present the background of this topic by the context of study. Additionally, the subheadings for this chapter will include the problem statement, research question, and research objective. It will be continued to know the significance of the study and definition of terms. Lastly, it will end with the summary as a conclusion for the entire introduction chapter.



## **SIGNIFICANCE OF THE STUDY**

This benefit research is very important to improve the quality of tourism services and it can give good feedback to the Min House Camp. Through this benefit, the relevant agencies can find out more clearly about community-based tourism. The study findings would be of immense value to the following:

### **1. Volunteer**

Volunteer is someone who gives their time willingly and uncompensated to charitable causes, especially aiding others. This volunteer work can help them in doing tasks faster. This will bring many benefits to volunteers because they can help without spending a lot of capital. Volunteers at Min House Camp will be exposed to a variety of skills and more knowledge and enable them to communicate well and thoroughly. Volunteers will work harder because there are various benefits received.

### **2. Tourism**

Tourists who come to Min House Camp will also feel satisfied and comfortable with all the services that have been provided there. The facilities provided allow tourists to be interested in the way the service is provided. When we travel, we can contribute to improving the local economy. One of the sectors that has been adversely impacted by the COVID-19 outbreak is the tourist sector. Tourists can also get to know the different cultures and traditions found at the Min House Camp. The strategic position allows tourists to make Min House Camp a stopover location for foreign and local tourists. Community-based tourism can be used as a tourism area in Min House Camp, Kubang Kerian because there are various services provided.

### **3. General public**

General public are people who are around the Min House Camp area. They can visit there to see the panoramic beauty of the village and see the beauty of the area. Min House Camp is a community-based tourism area that has a variety of unique flora and fauna. With various activities provided, the general public can do activities such as kayaking, fishing and so on to fill their free time while there. This is because, Min House Camp is also a resort that has been recognized by various travel agencies in Malaysia. Therefore, the quality of service at Min House Camp will continue to improve as many communities and people show a deep interest in tourism.

## **LITERATURE REVIEW**

### **Leadership**

Leadership involves leading a team or organization and inspiring followers towards a common goal, according to Livingston and C.I. Bernard. Min House Camp (MHC) is a Community-Based Tourism (CBT) in Kelantan run by local business people. It provides valuable learning opportunities, builds confidence, and develops leadership skills among participants. MHC offers various attractions in Kampung Pulau, including chalets, halls, a bee farm, a mini petting zoo, and water sports activities. Leaders guide and ensure safety during activities like kayaking. CBT keeps revenue within the community, and this study focuses on successful community-based tourism at MHC, emphasizing the leadership approach and the growth of SMEs (Blackman, 2008).

### **Tourism Management**

Tourism is considered crucial for nation's development and economic progress with predicted global arrivals surpassing 1.6 billion by 2020, according to the UNWTO. Tourism management is viewed as a promising employment industry due to the numerous career

prospects it offers in the public and commercial sectors. CBT empowers rural communities to manage tourism resources and engage in tourism services, contributing to community development. Tourism management handles and oversees activities related to the tourism business, providing education, expertise, and experience for managerial positions in the travel and hospitality sectors. MHC, a CBT enterprise in Kelantan, offers various tourism attractions, benefiting the locals through job opportunities, income generation, and entrepreneurial involvement. Coexistence and meeting changing expectations among local communities, government, non-governmental organizations, institutions, private businesses, and visitors are vital for success of CBT (Zhang et al., 2006).

## **Community Participation**

Community participation refers to the active involvement of community members in decision-making, problem-solving, and collective action to address local concerns and improve the community's well-being. Community participation is seen as a proactive process where visitors actively contribute their insights, skills, and knowledge to design and implement effective solutions, rather than just receiving information or benefits (Sarkission, Walsh et al., 1997:17). The visitors can visit MHC for holidays and vacations, engaging in visitors in visitor-oriented activities while enjoying the natural surroundings and sounds of birds chirping. Community participation can take various forms, including individual participation, group initiatives, attending neighbourhood meetings, volunteering, planning events, joining neighbourhood association, and collaboration with community leaders and stakeholders.

## **Tourism Network**

The UNWTO estimates that international tourist arrivals increased from 435 million in 1990 to 940 million in 2010, with a projected increase to 1.8 billion by 2030. In 2017,

international tourism contributed approximately 30% of global exported goods or services, 10% of global GDP, and 10% of global employment (UNWTO, 2018). Tourism network enhance the overall tourist experience by providing information, itineraries, festivals, events, websites, and recommendations, benefiting visitors to MHC. Networking involves interconnected groups of people who can share valuable information at MHC, including the local community showcasing their culture to educate tourists and foreigners. Employees can provide information to visitors about the community and attractions in MHC, strengthening the organization's relationship with visitors and fostering community engagement.

### **Success that Strengthen Community-Based Tourism in Min House Camp**

Understanding the current of the destination, community, and relevant variables is crucial for successful CBT (Nuzhar, 2016). Thus, MHC was chosen as a case study due to its exemplary practice of CBT. The central idea of CBT is the participation of the local community, as widely agreed by Mitchell & Ashley (2010), Lucchetti & Font (2013), and Telfer & Sharpley (2016). According to Taylor (1995), CBT relies heavily on interactions and relationships between local, tourists and other aspects of tourism. MHC in Kelantan benefits the local community by providing job opportunities and increased income through visitor engagement. CBT contributes to social and economic growth, community empowerment, ownership, and enhance the visitor experience. This study focusses on understanding the factors that make MHC a successful CBT development, rather than addressing any issues the organization may be facing it.

### **Research Hypothesis**

Using data from previous studies, it can be seen that all four of these elements are related to community-based tourism. Studies in the past have shown that the camp site offers so many distinctive experiences that are not available at other hotels in the city or town area but can be had at the Min House Camp, guests are very interested in visiting. There, one can gain new experiences and learn new things. Due to the numerous indoor and outdoor activities

that feature natural attractions like kayaking, fireflies, Kelulut bees, capturing Lokan, growing organic herb plants, cooking classes, and others, it's probable that many tourists want to visit and stay at the Min House Camp.

In this study, there were four hypotheses concerning the association between two variables:

**There is a relationship between the leadership towards the success that strengthen community-based tourism at Min house camp**

In order to implement sustainable growth inside a firm, leaders are essential. Thus, it is claimed that the primary driver of new improvements is leadership. Men (2012) noted that the presence of a trustworthy leader increased staff engagement in organizational improvements or adjustments and boosted employee confidence. The head of the Min House Camp is Muhamad Zanini (Cikgu Zanini) and Wan Noriah (Kak Yah), a respected individual in the group who possesses a broad perspective, effective communication skills, and innovation. Members are encouraged to engage in negotiations to secure funding and other forms of assistance to further their objectives. Therefore, this study will be concluding the hypothesis between the leadership towards the success that strengthen community-based tourism at Min House Camp.

*H1:* There is a good relationship between the leadership towards the success that strengthen community-based tourism at Min House Camp.

**There is a relationship between the tourism management towards the success that strengthen community-based tourism at Min House Camp**

Under the direction of the Min House Camp Tourism Board, Min House Camp was run in a touristic manner. Members of Min House Camp's tourist team look after visitors. The

goal is to work together maintaining the original way of life of the riverfront neighbourhood, including its culture, environment, and natural surroundings. The handling of tourism is seen generally favourable in Min House Camp. Everyone thinks they have the power to handle situations in order to bring about either their personal lives or the community are changing. Therefore, this study will be concluding the hypothesis between the tourism management towards the success that strengthen community-based tourism at Min House Camp.

*H2:* There is a good relationship between the tourism management towards the success that strengthen community-based tourism at Min House Camp.

### **There is a relationship between the community participation towards the success that strengthen community-based tourism at Min House Camp**

Long-standing community members are the most knowledgeable of one another and of the community itself, the core involvement must come from inside the community. Through involvement in tourism-related activities, the local population must be provided consideration and possibilities. Additionally, Min House Camp prevented local objections by enabling residents to understand how tourism gives benefits to the neighbourhood. Therefore, this study will be concluding the hypothesis between the community participation towards the success that strengthen community-based tourism at Min House Camp.

*H3:* There is a good relationship between the community participation towards the success that strengthen community-based tourism at Min House Camp

There is a relationship between the tourism network towards the success that strengthen community-based tourism at Min House Camp.

In order to maximize and grow capacity, networking is crucial. Data sharing occurs as a result of individuals within the network having an impact on information and resource turnover. Based on the intricacy of the data, this is an efficient form of communication. The network is constantly connected thanks to networking and any choices are sent to all group members. Numerous networks that transport tourists to renowned locations, including the Min House Camp community and villagers, are advantageous to Min House Camp. This is a crucial component of community-based tourism, which helps to prevent rivalry and conflict. Therefore, this study will be concluding the hypothesis between the tourism network towards the success that strengthen community-based tourism at Min House Camp.

*H4:* There is a good relationship between the tourism network towards the success that strengthen community-based tourism at Min House Camp.

## Research Framework

As a result of previous literature review, the researcher has proposed a framework to study the success that strengthen community-based tourism Min house camp. Hence, as seen below, the diagram:

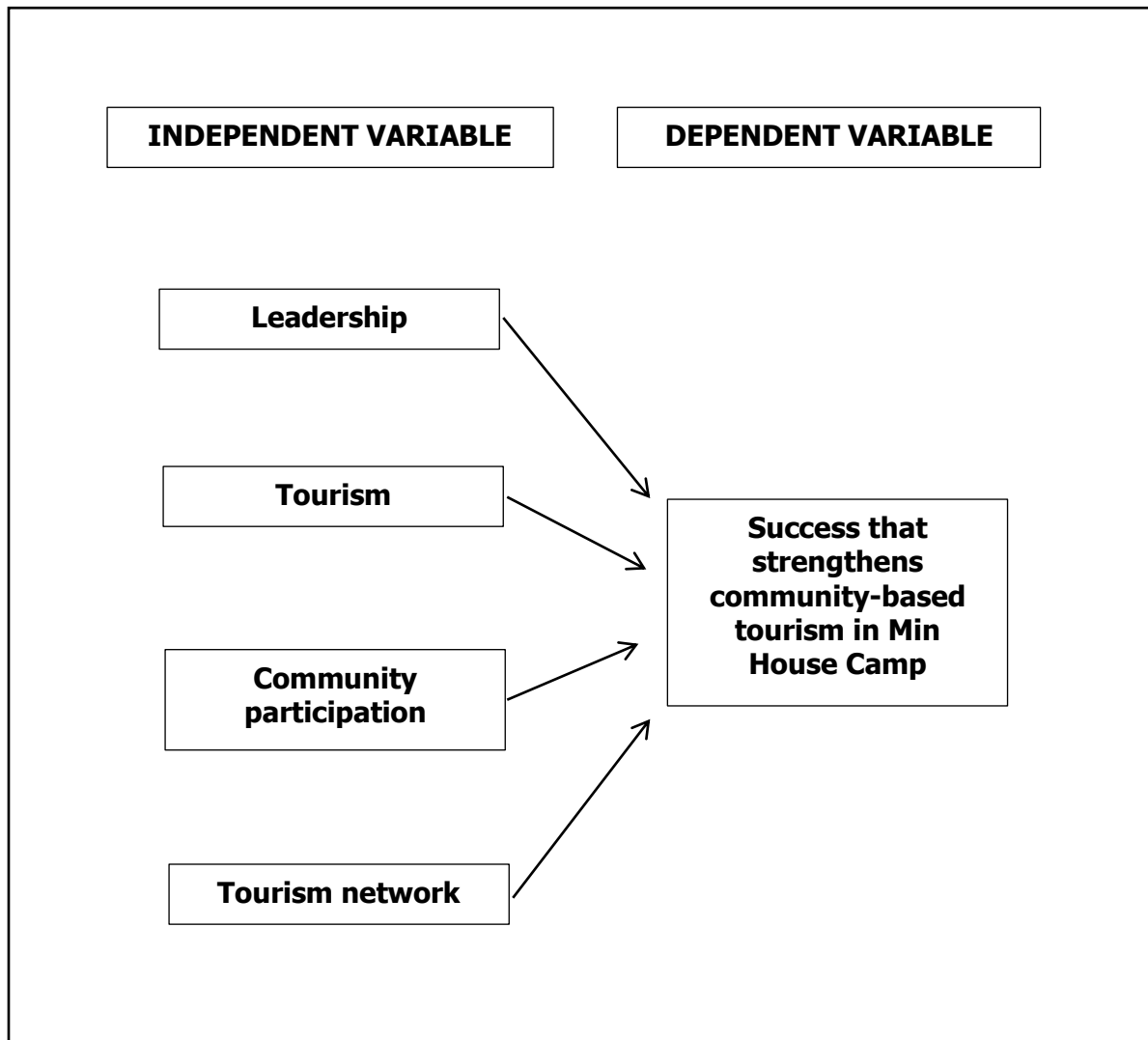

Figure 2.1: Conceptual framework.



## **METHODOLOGY**

### **Research Design**

Research design specifies the process of gathering and processing data efficiently while aligning with research objectives (Kothari, 2004). It provides guidelines for researchers to achieve their study objectives and test hypotheses (McDaniel and Gates, 1999). The selection of a study design, whether exploratory, descriptive, or causal, is crucial as it determines how information will be collected and reported. The collection of research design has 3 namely exploratory research, descriptive research and causal research.

Furthermore, in order to carry out this research, all sources for the first information should be consulted using secondary data existing data sources. If there is no information or it is still available but not enough to answer the objective research questions, researcher needs to choose an approach for data collection using primary data.

In this study, the research design was quantitative. This quantitative method is the only data collection method involving numbers. This is because the data collection uses the primary data. The method used in this study is causal research. When one variable is thought to be able to influence the other variable, it gives the researcher more information when determining the casual relationship between the variables in the study.

### **Data Collection**

Data collection involves gathering, quantifying, and evaluating accurate insights using established techniques (McLaughlin, 2018). It is a crucial step in research projects and allows researchers to assess their hypotheses. Primary data, collected through interviews, questionnaires, experiments, and other means, is used in this study to generate evidence supporting the chosen topic and objective.

Nowadays, everyone owns a smartphone and communicates with friends, family, and others via it without ever physically meeting. This study contacts the respondent via a Google Form so they can fill out the questionnaire and submit all of their responses. Using social media platforms like *Instagram*, *Telegram*, and *WhatsApp* can make it simpler to contact the respondents. For instance, to contact respondents from Johor and Kelantan, simply share the link to the Google form. Researchers utilize Google Forms because they can save money and time by using them to answer surveys and quickly and effectively gather data.

Part A, Part B, and Part C are the three sections that make up the Google form. There are six questions in Part A that pertain to the demographic segmentation of the respondents. The questions in this section are based on information about the demographics of the population, such as age, gender, work status, and marital status. The subjects in the dependent variable (section B) pertain to community-based tourism. The last part is independent variables (section C) generate inquiries regarding variables that influence visitors, product and services that may increase visitors, and issues and challenges in managing the community.

## **Sampling**

According to Shona McCombers (2019), sampling methods is a sample a representative sample of those who will actually take part in the study. The study must carefully consider how to choose a representative sample of the complete group in order to draw accurate conclusions from the results. Due to this, it can get a sample that contradicts the population for consideration. There are two types of sampling methods that can be used in this study, that is probability sampling and non-probability sampling. Therefore, this study will analyze the data guided by the framework through sampling.

This study utilizes convenient sampling, a non-probability sampling technique often used when probability sampling is not feasible. Convenient sampling aims to produce a sample

that reflects the proportions of the overall population of interest (Moser & Stuart, 1953). However, online non-probability sampling methods can introduce biases due to under coverage and non-response. Non-probability sampling involves some form of random selection, but it also allows for bias based on the characteristics of participants who choose to participate in the survey.

In this research, convenient sampling was used as a technique to gather data from easily accessible individuals in the community. This involved selecting available respondents to gather information. For instance, in the case of promoting Min House Camp as a tourist spot, the research aimed to understand the community's perspective on using Min House Camp as a tourist destination after the Covid-19 pandemic. The survey conducted within the local community provided insights from individuals who shared similar financial backgrounds, ethnic heritage, values, and inclinations related to community-based tourism at Min House Camp.

The purpose of this sampling method that is convenient sampling is to create a conclusion to understanding success factor strengthen Min House Camp as a community-based tourism in Kelantan after Covid-19. The research also collected data from the owner and tourist at Min House Camp. Data obtained from respondents will be collected by using google form to get responses from those involved and shared on *WhatsApp* applications and so on. Through the interview, all the information obtained will be faster.

### **Data Analysis**

As a guide for individuals who are interested in the fundamentals of data analysis, the study claims that data analysis is something that combines mathematics and necessitates a more in-depth study in order to know something (Brandt, 2014). Additionally, it has been

suggested that the study of data analysis is beneficial for those working in the fields of science and engineering because they require a basic knowledge of the statistical techniques used to analyze experimental data and solve problems (Brandt, 2014). We employed a variety of methodologies for this data analysis in order to collect all the data required to provide a more robust justification for the project's title.

## **Descriptive Statistic**

Descriptive statistics provide an understandable summary and description of the data (Zikmund et al., 2013; Creswell & Creswell, 2017). consequently, both the independent and dependent variables in this study were converted into a descriptive statistic. Measuring central tendency (mean, median, and mode), measuring dispersion (range, variance, and standard deviation), and determining the distribution's shape are some examples of descriptive statistics that are frequently used. Tables, graphs and plots are frequently used to show descriptive statistics, which can help in displaying the data and making it simpler to understand. To describe the fundamental characteristics of the data in a study, descriptive statistics are used. Using descriptive statistics, quantitative descriptions are provided in a clear manner. Descriptive statistics allow us to logically simplify enormous amounts of data. Every descriptive statistic condenses a large amount of data into a shorter description.

## **Reliability Analysis (Cronbach Alpha)**

Measure internal consistency is now a characteristics of reliability analysis. The level to which any indication of a thought appears to be consistent at some basic levels is referred to as internal consistency (Zikmund et al., 2013; & Creswell, 2017). Reliability tells how consistently a method measures something. The results will be the same when the same method is applied to the same sample under the same circumstances. If not, the measurement

technique might not be accurate, or bias might have snuck into the study. The straightforward measure of Cronbach's alpha can be used to assess reliability.

Table 1: Rule of Thumb Cronbach' Alpha

Cronbach Alpha	Classification
$\alpha \geq 0.9$	Excellent
$0.9 > \alpha \geq 0.8$	Good
$0.8 > \alpha \geq 0.7$	Acceptable
$0.7 > \alpha \geq 0.6$	Questionable
$0.6 > \alpha \geq 0.5$	Poor
$0.5 > \alpha$	Unacceptable

### Pearson Correlation Analysis

The statistical tests that assess the correlation or link between two constant variables are determined by Pearson correlation. It merely offers a measure of how monotonically a relationship between two variables can be stated, or how well a monotonic function can capture that relationship. The Pearson's correlation coefficient measures the direction and the intensity of the association between two ranking factors, abbreviated as:

Table 3.4 Rule of Thumb for interpreting Pearson's correlation.

Cronbach Alpha	Classification
$\alpha \geq 0.9$	Excellent

$0.9 > \alpha \geq 0.8$	Good
$0.8 > \alpha \geq 0.7$	Acceptable
$0.7 > \alpha \geq 0.6$	Questionable
$0.6 > \alpha \geq 0.5$	Poor
$0.5 > \alpha$	Unacceptable

Statistical Package for the Social Sciences (SPSS) is the official name of the programmed that we use to analyze the data. A popular software package for finding information and data is called SPSS (Frey, 2017). Utilizing SPSS has the benefit of being a particularly suited tool for processing social science research data. They include those in the medical, educational, and marketing industries. Additionally, this software is excellent for learning statistical data. Because this programmed accurately analyzes the data, it may be used to produce accurate data about society. It can also create independent variables that will be closely related to dependent factors.

## **FINDINGS**

The key findings of the study based on the recapitulation of the results from the data analysis results and on the study's objectives, research questions, and hypotheses. The first findings of the study to determine the leadership traits that strengthen Min House Camp as a community-based tourism product. Based on the mean descriptive statistic, Min House Camp has successfully achieved success in strengthening its position as a tourist focus area around the local community. The results show that the strength of success in the community is very well received and has influenced the community to make a decision as a tourism center in Min House Camp after Covid-19. Based on the

research, Min House Camp is very suitable to be made as a community-based tourism place because there are various facilities and facilities that have been provided there and can attract more communities around Min House Camp. This is because, its position has become a very significant focus causing Min House Camp to be used as a tourist spot. The surrounding community also managed to strengthen its position after the outbreak of COVID19.

Based on the findings of the data analysis, tourist management has a considerable link with the local community to boost the effectiveness of community tourism at Min House Camp. H2 reflects the findings on the correlation between the independent and dependent variables. Most of the respondents agree more with tourism management because it can form a community to achieve success in better tourism management and enable the community to successfully shape the success of Min House Camp as a tourist destination. For example, they can recommend Min House Camp on social media platforms such as *Facebook, Instagram, Tiktok* and more to enable local communities and tourists to choose Min House Camp as a tourist destination. In terms of employment prospects and revenue potential, having a community-based tourism business in Min House Camp has benefited the locals. It has also provided opportunities for the entrepreneur to become involved with the organization. As a result, after the pandemic of Covid-19, the tourism management around Min House Camp have been successful in forming a community that successfully attracts tourists to come there.

The third objective of the study is to see how community participation between significant relationships towards the success strengthens community-based tourism at Min House Camp after the Covid -19. According to the mean in descriptive statistics, Community participation in Min House Camp has received a very good response from tourists because they successfully promote the tourism center. This is because, the responsibility that they have to do is managing and handling the communications with the visitors in both directions with the visitors in Min House Camp. As a result, the findings of this study show that the participation of this community is getting a very encouraging

response because Min House Camp is a very popular tourist spot for both foreign and domestic tourists.

Previous study from the World Tourism Organization (UNWTO, 2012 ) can support the objective fourth for this research by the relationship between the tourism network towards the success that strengthens community-based tourism at Min House Camp. This objective four is moderately accepted and supported in this study. As a result, H4 was approved in this research. To help tourists and foreigners learn more about our culture, the Min House Camp community can demonstrate or convey aspects of our way of life community-based tourism, which places a focus on serving local needs and is non-competitive and environmentally benign (Fennell (1999)).

## **DISCUSSION AND RECOMMENDATION**

Based on the results, leadership influences Min House Camp to enhance community-based tourism. Leadership and community-based tourism are positively correlated, and the correlation coefficient is 0.852. An earlier study that looked at whether there were any connections or relationships between the dependent and independent variables supports this conclusion. The research purpose is supported and H1 is proven because both variables' significant levels are 0.000, which are extremely significant.

In order for tourists to experience community-based tourism in Min House Camp and learn about the local culture, it is intended that this paper will share ideas with interested parties. The proprietor of Min House Camp can design a beautiful aesthetic space to draw visitors and help them make cherished family, friend, and relative memories here. In addition, they can encourage visitors to engage in community-based tourism activities like walking through the village, participating in handicrafts or painting, visiting a local market, and making and eating local cuisine. It can help tourists have a nice time, take in the breath-taking views of nature, and spend quality time with their loved ones This is one of the best ideas to foster camaraderie between the employees and the visitors and to



help them build wonderful memories while they are here. Therefore, it is strongly advised that researchers employ a big simple size for subsequent research. This is so that the study's larger samples can be more representative of the general population.

## **CONCLUSION**

In conclusion, the research aimed to examine the success that strengthen the community-based in Min House Camp. The results demonstrate of four main factors that strengthen Min House Camp as a community-based tourism, which are: (i) leadership; (ii) tourism management; (iii) community participation; (iv) tourism network. The local population in the region has realised how quickly the place has developed into a tourism hub. This study is a synopsis of multiple chapters outlining the Min House Camp community-based strengthening components.

## REFERENCES

- Abdullah , A., Wahid, J., Khalil , K., & Boudiaf , B. (2022). Towards the Future of the Malay Community in Kelantan. *10th AMER International Conference on Quality of Life*, 1-8. Azmi, A., & Ahmad, J. A. (2022). Developing Malaysia's smart community-based tourism model. *Jurnal Intelek*, 17(2), 102-112.
- Abdullah, F., Raja Daud, R., Othman, N., Abd Razak, N., Bah Simpong, D., & Muhamed Yusof, A. (2022). The Relationship of Ecotourism Development towards Ecotourism Destination Competitiveness A Case Study in Kelantan. *IOP Conference Series: Earth and Environmental Science*, 1-9.
- Abdullah, S., Haji Othman, M., & Ya'acob, F. (2019). STAKEHOLDERS' INVOLVEMENT AND THEIR PERCEPTIONS IN SUPPORTING COMMUNITYBASED ECOTOURISM IN MIN HOUSE CAMP, KUBANG KERIAN. *Journal of Tourism, Hospitality and Environment Management*, 4 (16), 70- 83.
- Adha, M. M. (2019). Advantageous of Volunteerism Values for Indonesian Community and Neighbourhoods. *International Journal of Community Service Learning*, 3(2). <https://doi.org/10.23887/ijcsl.v3i2.17779>
- Akter, M., Sadekin, M. N., & Patwary, A. K. (2020). An Empirical Study on Students' Satisfaction from Mawlana Bhashani Science & Technology University, Bangladesh. *Review of Economics and Development Studies*, 6(2), 363-379.
- Al Mahmud, S. R. (2020). The effectiveness of Facebook advertisements on purchase intention of customers in Malaysia. *South Asian Journal of Social Sciences and Humanities*, 1(1), 97-104.
- Alom, S., Patwary, A. K., & Khan, M. M. H. (2019). Factors affecting the turnover intention of Bangladeshi migrants in the United Arab Emirates: An empirical study on the hotel industry. *International Journal of Innovation, Creativity and Change*, 8(3), 344-360.
- Amerta, I. M. S. (2017). Community based tourism development. *International Journal of Social Sciences and Humanities*, 1(3), 97-107. <https://doi.org/10.29332/ijssh.v1n3.60>
- Baker, K. (2019). *The Ultimate Guide to Community Management*. Hubspot.com. <https://blog.hubspot.com/marketing/community-management-expert-advice>
- Cresswell, J.W. (2003). *Research Design Qualitative and Quantitative and Mixed Method Approaches*. 2nd ed. Thousand Oaks, CA: SAGE
- Explorable. (2019). *Research Population - The Focus Group of a Scientific Query*. Explorable.com. <https://explorable.com/research-population>
- Fengmin, Z., Baijun, W., Jiangtao, B., Li, L., & Patwary, A. K. (2022). Investigating revisit intention of medical tourists in China through nutritional knowledge, perceived medical quality, and trust in the physiologist: A recommendation on health tourism policy measures. *Frontiers in Public Health*, 10, 893497.
- Hassan, A. (2022). *Technology Application in Tourism in Asia*. Springer.
- Hazbar, A. M. H., Alem Mohammed, A., & Karim, A. K. A. (2019). An Empirical Study of Factors Influencing hotel customers' online booking Intention. *مجلة العلوم التربوية و الدراسات الإنسانية*, (5), 1-17.
- Kamaluddin, A., Khan, N., Nadiah, N., Valeriani, D., Faisal Akbar, M., Mara, C., Selangor, K., & Alam, M. (n.d.). Sustainability of Homestay Operators in Malaysia During The Covid-19 Pandemic. *International Journal of Innovation, Creativity and Change*. [Www.ijicc.net](http://www.ijicc.net),

16(2), 2022. Retrieved January 17, 2023, from [https://www.ijicc.net/images/Vol\\_16/Iss2/16212\\_Kamaluddin\\_2022\\_E1\\_R.pdf](https://www.ijicc.net/images/Vol_16/Iss2/16212_Kamaluddin_2022_E1_R.pdf)

- Kampetch, P., & Jitpakdee, R. (2019). The potential for key success of communitybased tourism sustainability: Case study Baan Rim Klong Homestay, Samut Songkram, Thailand. *ABAC Journal*, 39(4), 111-122.
- Kothari, C. R. (2004). *Research methodology : methods & techniques* (2nd ed.). New Age International (P) Ltd., Publishers, Cop.
- lamm, A., & Lamm, K. (2019). Using Non-Probability Sampling Methods in Agricultural and Extension Education Research. *Journal of International Agricultural and Extension Education*, 26(1), 52–59. <https://doi.org/10.5191/iaee.2019.2610564>
- Li, L., Ragavan, N. A., Patwary, A. K., & Baijun, W. (2022). Measuring patients' satisfaction toward health tourism in Malaysia through hospital environment, nutritional advice, and perceived value: A study on Chinese exchange students. *Frontiers in public health*, 10, 893439.
- Li, L., Wu, B., & Patwary, A. K. (2022). How marine tourism promote financial development in sustainable economy: new evidences from South Asia and implications to future tourism students. *Environmental Science and Pollution Research*, 29, 1155-1172.
- Li, L., Wu, B., & Patwary, A. K. (2022). The psychosocial factors affecting chinese Outbound Exchange and mobility students' academic performance during COVID-19. *Frontiers in psychology*, 13, 872516.
- Mitchell, R. E., & Reid, D. G. (2001). Community integration. *Annals of Tourism Research*, 28(1), 113–139. [https://doi.org/10.1016/s0160-7383\(00\)00013-x](https://doi.org/10.1016/s0160-7383(00)00013-x)
- Mtapuri, O. C., & Dłużewska, A. (2022). Advancing community-based tourism approaches for the sustainable. *Sustainable Development*, 1-24.
- Mtapuri, O., Thanh, T. D., Giampiccoli, A., & Dłużewska, A. (2021). Expansion and Specification of Knowledge, Skills, Attitudes and Practices Survey Model for Community-Based Tourism Development. *Sustainability*, 13(19), 10525. <https://doi.org/10.3390/su131910525>
- Mukherjee, R. (2019, September 30). *How to choose your sampling strategy to guarantee relevant results*. Retrieved from <https://datajourney.akvo.org>: [https://datajourney.akvo.org/blog/how-to-choose-your-sampling-strategy-to-guarantee-relevant-results?utm\\_term=sampling](https://datajourney.akvo.org/blog/how-to-choose-your-sampling-strategy-to-guarantee-relevant-results?utm_term=sampling)
- Noorashid, N., & Chin, W. L. (2021). Coping with COVID-19: The Resilience and Transformation of Community-Based Tourism in Brunei Darussalam. *Sustainability*, 13(15), 8618. <https://doi.org/10.3390/su13158618>
- Patwary, A. K., Roy, B., Hoque, R., & Khandakar, M. S. A. (2019). Process of developing a community based tourism and identifying its economic and social impacts: An Empirical study on Cox's Bazar, Bangladesh. *Pakistan Journal of Humanities and Social Sciences*, 7(1), 1-13.
- Pratt, M. (2017, November). *What is leadership?* SearchCIO. <https://www.techtarget.com/searchcio/definition/leadership>
- Singh, A., Bathla, G., & Raheja, K. (2022). Current and Futuristic Trends in Accommodation Sector.
- Sriyani, G. T. W. (2021). Impact of competitive capabilities empowered by community-based tourism projects on tourism businesses success in rural tourism destinations. *Journal of Business Studies*, 8(0), 156
- Sumethokula, P., Patwary, A. K., Srinuanpanc, B., Srinuanpand, C., Suwandee, P., Thammathikul, A., & Phanong, W. (2020). The potential of new tour repackaging for creative tourism among

- entrepreneurs in Nakhon Si Thammarat. *International Journal of Innovation, Creativity and Change*, 13(10), 1752-1771.
- Suthamma Nitikasetsoontorn. (2015). The Success Factors of Community-Based Tourism in Thailand. *NIDA Development Journal*, 55(2), 24–58. <https://doi.org/10.14456/ndj.2015.2>
- Tourism Management - Introduction* Tutorialspoint. (n.d.). [www.tutorialspoint.com](http://www.tutorialspoint.com). [https://www.tutorialspoint.com/tourism\\_management/tourism\\_management\\_introduction.htm#:~:text=What%20is%20Tourism%20Management%3F](https://www.tutorialspoint.com/tourism_management/tourism_management_introduction.htm#:~:text=What%20is%20Tourism%20Management%3F)
- Truptimayee, R. (2019, November 11). *What is Leadership? - Definition, Concept, Importance & Leadership Skills*. Economics Discussion. <https://www.economicsdiscussion.net/management/leadership/what-is-leadership/32116>
- Wu, B., Liu, S., Wang, J., Tahir, S., & Patwary, A. K. (2021). Assessing the mechanism of energy efficiency and energy poverty alleviation based on environmental regulation policy measures. *Environmental Science and Pollution Research*, 28, 40858-40870.
- Wu, B., Zhai, B., Mu, H., Peng, X., Wang, C., & Patwary, A. K. (2021). Evaluating an economic application of renewable generated hydrogen: A way forward for green economic performance and policy measures. *Environmental Science and Pollution Research*, 1-15.
- Yanes, A., Zielinski, S., Diaz Cano, M., & Kim, S. (2019). Community-Based Tourism in Developing Countries: A Framework for Policy Evaluation. *Sustainability*, 11(9), 2506. <https://doi.org/10.3390/su11092506>

# Factors Influencing Revisit Intention of Community-Based Tourism in Tok Bali, Kelantan; Tourist Perspective

Nur Syafiqah Imran, Nur Syafiqah `Ainaa Syahrul Nizam, Nur Syahirah Sabri, Nur Syaidatul Izzati Che Mohd Zambri & Raja Norliana Raja Omar\*

*Faculty of Hospitality, Tourism and Wellness, Universiti Malaysia Kelantan*

[norliana.ro@umk.edu.my](mailto:norliana.ro@umk.edu.my)

---

## ABSTRACT

Tourists' revisit intention towards community-based tourism destinations in the context of a developing country. Atmosphere, cultural environment, and destination brand attachment towards community-based tourism destinations in a developing country are investigated to determine what contributes to tourists' revisit intention. The study suggests to practitioners that it is crucial to understand the impact of atmosphere, cultural environment, and destination brand of community-based tourism destinations, as well as revisit intention, especially, in developing effective marketing strategies for better market segmentation and targeting. The main data for the study will be collected by using a structured questionnaire, and the analysis will be done by using SPSS software. This study surveyed tourists from community-based tourism destinations in Kelantan, Malaysia. Thus, the outcome of this study will help to expand the current knowledge on similar areas of community-based tourism destinations, and the contributory effect of atmosphere, and cultural environment on re-visit intention towards community-based tourism destinations in a developing country context.

**Keywords:** Atmosphere Cultural environment; Destination brand; Revisit Intention; Community-based tourism destination.

---

## INTRODUCTION

Sustainable tourism development expands on this idea by focusing on environmental, social, and economic issues and taking action to lessen any negative effects that the industry may have on these areas. Tourism is probably one of the largest and fastest-growing sectors in the world today (Daniloska & Hadzi Naumova, Mihajlovska, 2015). This industry has made remarkable strides toward establishing itself as a major driver of overall economic growth. According to the World Tourism Organization, tourism accounts for 9% of global GDP (2014). Additionally, according to estimates from the global tourism sector, over 5 billion domestic visitors and over 1050 million foreign tourists traveled to various tourist spots in various nations in 2013.

Malaysia's tourist sector is one of the fastest expanding (Shariff & Abidin, 2013). By generating foreign currency, assuring job possibilities, raising tax revenues, and extending economic prospects to local populations, it significantly boosts the nation's Gross Domestic Product (GDP). Malaysia's government has taken practical measures to promote this industry (Siti-Nabiha, Abdul Wahid, Amran, Haat, & Abustan, 2008). In order to promote the growth of Malaysia's tourist industry, the government established the Tourism Policy in 1992. However, due to Malaysia's diverse civilization, the importance of the growth of the tourist sector to local economies varies across the nation. Since

community-based tourism destinations are a growing sector of 2 tourism in developing countries, particularly Malaysia, focusing on them in Malaysia's remote regions may present a chance to implement the government's tourism strategy successfully (Chin & Lo, 2017).

The newest type of tourist product is community-based tourism (CBT), in which local communities oversee and coordinate the majority of tourism-related activities. Since community-based tourism forbids the involvement of outside parties, local residents are completely responsible for carrying out all aspects of tourist management. The primary goal of community-based tourism is to organize the production and delivery of tourism services to visitors. Through community-based tourism, tourists are also given the opportunity to learn about the way of life, culture, and customs of the community (Kaur et al., 2016). Although Tok Bali, Kelantan has demonstrated the acceptable growth of community-based tourism, the study is still needed to determine how tourists perceive the region and if they plan to return. Tok Bali, Kelantan has demonstrated that community-based tourism can grow in an acceptable way, but more research is needed to understand how visitors view the area and whether they intend to return (Abdul & Lebai, 2010). In previous research, the outcomes of visitor experience and satisfaction were frequently cited as the causes of visitors' revisit intention or behavioral intention (Cole & Chancellor, 2009).

Discussion of pertinent literature and research methodologies serves to create the remainder of the essay. This study thus poses the question of whether factors influencing various tourist perspectives towards community-based tourism destinations 3 have any impact on revisit intention as well as the mediating role of attachment factors between tourist perspective and revisit intention. The study is described first, and then the analysis and results are discussed. Finally, it is agreed that the study will support the results and implications of the study in the paper's final section.

The research objectives are:

1. To investigate the relationship between tourist perspectives on Tok Bali, Kelantan.
2. To investigate the relationship between tourists, revisit the intention to visit Tok Bali, Kelantan.
3. To investigate the relationship between the attractions at Tok Bali, Kelantan that can attract tourists to revisit the place.

## **SIGNIFICANCE OF THE STUDY**

### **Significance to Practice**

This investigation could assist local stakeholders in the development of tourism strategies by highlighting the many factors involved in creating community-based tourism (CBT). As a result, the research was thought to help with long-term planning. The community-based tourism (CBT) procedure has aided in establishing and bolstering sluggish tourism sectors while supplying rural inhabitants with employment and expanded economic options (Butts & Sukhdeo-Singh, 2010; Srisuwan, Chantachan, & Thidpad, 2011). In order to help tourist planners, understand how the local community will react to industry changes, the study's findings may be used to guide the implementation of plans.

### **Significance of Social Image**

This research should assist Tok Bali, Kelantan, in experiencing positive social change, as community-based tourism (CBT) strategy based on community feedback should strengthen the state's tourism sector and increase foreign currency inflows. The 8 development of more new businesses, more government spending, and more private sector, spending all benefit from increased foreign exchange. These economic stimulus measures ought to increase the number of jobs available. Although there is

no agreed-upon definition of community-based tourism (CBT), Salazar (2012) stated that it aims to give community members more control.

Given the growing importance of the tourism sector in terms of GDP contribution, it is necessary to investigate the factors that influence a destination's tourist appeal (Omerzel, 2011). People are drawn to and spend time at a tourist location because of its appeal (Omerzel, 2011). According to L. S. Stone and Stone (2011), CBT boosted and revitalized the tourist sectors of various nations. Therefore, the introduction of CBT to Tok Bali may aid the struggling tourism sector. Reviving Tok Bali, Kelantan, and the tourist sector ought to boost travel demand and boost the country's economy as a result.

## **DEFINITION OF TERMS**

### **Tourist's Perspective**

(Verma, D., 2015) The researcher finding the tourist/visitor seeks various emotional and physical experiences and satisfactions from tourism. And the nature of these encounters will largely determine the locations picked and the activities experienced, appreciated or participated in. Revisit Intention According to (Um, S., Chon, K., & Ro, Y., 2006), relative to the start decision. making process, the intention to revisit has been seen as a continuance of satisfaction. The chance of repeat business may be influenced by several independent factors, including perceived performance quality throughout the on-site and post-purchase phases, the destination's distinctiveness, and the research finding (Um, S., Chon, K., & Ro, Y., 2006).

### **ATMOSPHERE**

The reason "atmosphere" is a good starting point for measurement, according to research (Bauer et al., 2005; Pfaff, 2002), is that it can help people become aware of a space's design elements through sight, smell, touch, and taste. It can also be used as a management tool to influence visitor behaviour and attitudes (Heide & Grnhaug, 2006).

This study sees the interconnected components of creative people, creative processes, creative goods, and creative environments/presses as forming the "creative atmosphere" (CA) of "creative tourist destinations," which is defined as a distinct ambiance with visual and emotional appeal (G. Richards, 2011; G. Richards & Wilson, 2006). As a result, CA is philosophically open-ended.

Examples of how the creative environment in a creative district is created to pique and stimulate traveler interest include the cooperative efforts of travel writers, bloggers, and painters, the creation of artistic works, and the growth of interaction at the levels of "creative environment," "creative people," "creative product," and "people-tourist" (Uhrich & Benkenstein, 2010). However, what does CA actually mean and how is it determined? There are still gaps in the literature and opportunities for future research on these topics.

One of the numerous stunning beaches that line Kelantan's shore is Pantai Tok Bali. Due to the dense casuarinas that surround it, Tok Bali Beach is more serene and peaceful than other, more well-known beaches. Visitors will only find peace at this beach because it is one of the more secluded ones in Kelantan. Visitors can enjoy the warmth of the tropical sun and the cooling effect of the pleasant sea wind without the hassle of large crowds. Due to the beach's seclusion, there is plenty of room for picnics and group games, or tourists can go swimming in the comparatively shallow waters.

When needed, the densely growing casuarinas along the beach provide significant shade from the hot sun. A red-orange glow will greet visitors at dusk as it lowers to meet the open horizon, creating a romantic atmosphere. The beach is most popular for its isolation from crowded areas, which makes it a wonderful and tranquil escape, rather than the calm waves and sand beach.

## **CULTURAL ENVIRONMENT**

The three-part framework of economy, society, and environment, which has recently been enhanced and supplemented by the cultural dimension, has been used to examine the complicated and contentious relationship between tourism and development from a number of angles. (K. Soini and I. Birkeland, 2014).

The three pillars of "sustainability," the bases on which tourism values, processes, and choices may be negotiated and implemented, gain further analysis and operationalization the cultural aspect of sustainability issues, resource uses, practises, demands, and interests, etc., including tourism prospects and repercussions, is included.

The most fundamental and all-encompassing social dimension in every location is culture, which encompasses all facets of human existence and cognition as well as their resultant products, activities, meanings, symbols, representations, etc. In Tok Bali, Kelantan they still maintain Malay culture to attract visitors from abroad to know more about Malay tradition.

Tourism's cultural environment has a mutually beneficial relationship that can increase the attractiveness and competitiveness of destinations, regions, and countries. Culture is gradually becoming an important factor in attracting tourists, creating distinction in a crowded global marketplace. Creating a difficult relationship between tourism and culture can help destinations become more appealing as places to live, visit, and spend.

## **DESTINATION BRANDS**

Destination branding is the foundation of marketing strategies and the most important marketing tool in the tourism sector for shaping the images of places in the minds of potential tourists and other stakeholders by emphasizing the exclusivity of these locations (Tasci, A.D.A., and Kozak, M. 2006). It's important to remember that place branding, also known as destination branding, is intricate and plays a significant part in local and corporate marketing initiatives aimed at attracting tourists to the area (Rudolf, W.; Wraas, A. 2021).

Branding benefits businesses as well as buyers. One of its responsibilities is to help customers recognize products and judge the caliber and consistency of the product. Brands allow one manufacturer to be held accountable for the product's performance. Another function of a brand is to facilitate decision-making and lessen the risk that consumers perceive. According to Aaker (1991), the purpose of a brand is to inform customers about the product's origin and to shield the producer from competitors who might provide similar goods.

According to these viewpoints, a brand serves as a tool for consumers' decision-making. In Tok Bali, they do their branding by promoting their place on social media, on websites, and other digital facilities.

## **HYPOTHESIS**

The research hypothesis is made based on research factors influencing service, environment, and facilities and the confirmed factors that directly revisit the intention of community-based tourism in Tok Bali, Kelantan.



H1: There is a significant relationship between atmosphere and revisit intention among tourists in Tok Bali, Kelantan.

H2: There is a significant relationship between the cultural environment and the intention to revisit Tok Bali, Kelantan.

H3: There is a significant relationship between destinations and brand attractions at Tok Bali, Kelantan, that can attract tourists to revisit the place.

### Research Framework

The important part is the conceptual framework, which is intended to demonstrate the relationship between the independent and dependent variables, as shown in Figure 2.1:

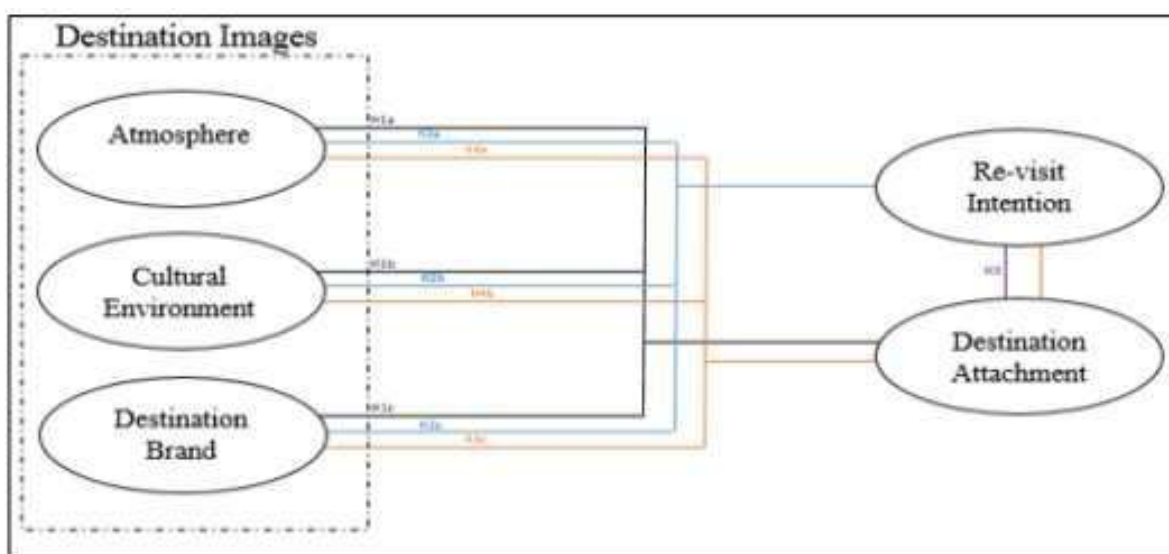

Figure 2.1: Conceptual Framework

## METHODOLOGY

### Research Design

The researcher's research design shapes the methodologies and approaches that will be used. The focus of research can be on developing successful studies using methodologies that are appropriate for the subject. The three main categories of study designs are data gathering, measurement, and analysis.

### Population

A population is a group of people with whom we want to come to terms. In research, a population is typically not related to humans. It can refer to a group of objects, events, organizations, countries, species, and organisms that are being researched. The population of this study includes all residents of Tok Bali, Kelantan, who have an impact on tourism.

### Sample Size

Fleetwood (2021) defines a sample as a smaller data set that is collected or selected by a researcher from a larger population using a particular selection method. The size of the sample is useful in gaining insight into a group of people chosen from the general population, and it is thought to be representative of the true population for that particular research. The sample for this study will be selected from the target population.

## **Sampling Method**

The selection of a sufficient number of elements from a population is known as sampling. Researchers will be able to generalize traits or characteristics to aspects of the population after conducting sample studies and understanding the traits or characteristics. Survey questionnaire is relatively easy because it can reach respondents more closely and the data obtained is more accurate. To select respondents among random peoples, a simple random sample was used to target 340 peoples, factors affecting revisit intention. The researcher can select the sample size and pick the communities conveniently.

## **Data Collection Procedure**

Structured equation modeling, a Google form, and use software SPSS (Statistical Package for the Social Sciences), generally known as IBM SPSS Statistics, is a software package used for statistical data analysis. Refers to its first application in the social sciences, it has since been used in other data markets. Research in the fields of healthcare, marketing, and education frequently uses SPSS. Analyses a wide range of data types. Survey results, client databases from businesses, Google Analytics, the findings of scientific study, and server log files are examples of common sources. Almost all formats of structured data, as well as many different types of data, are supported by SPSS for analysis and customization. Spreadsheets, simple text files, and relational databases like SQL, SATA, and SAS are all supported by the software.

In order to get the essential information for this analysis, questionnaires were given to representatives, who completed them and provided the necessary information. Residents of the state of Kelantan who agreed to participate in the study by answering questions online were given the questionnaire. The respondent will be given a questionnaire with 20 questions in order to learn more about the factors influencing tourists' perspectives in community-based tourism toward reliability and revisit intention at Tok Bali, Kelantan. The questionnaire is divided into three sections: Part A, Part B, and Part C. Section A, includes demographic elements that collect background information from respondents, such as name, gender, and age. Section B includes questions about three aspects of tourists' perspectives. Section C includes questions about tourists' plans to return to Tok Bali, Kelantan. The question also asked the respondent to rate the extent of their agreement with each element.

## **Research Instrument**

An observation-based interview and a questionnaire are part of a set of measuring tools known as research instruments that are used to gather useful information from target respondents on a certain topic. Therefore, it is essential the inquiry that the right study instrument be chosen for data gathering. Research tools can be classified as either qualitative or quantitative.

Qualitative research has a tone of evidence. According to Creswell, Hanson, Clark- Plano, and Morales (2007) and Hamilton and Finley (2019), qualitative researchers have access to a variety of data collection tools from which to choose based on their research objectives and proficiency with them. In order to specifically collect pertinent data for a study objective, it conducts a face-to-face conversation between a researcher and participants. A focus group discussion guide, according to Guest (Namey, Taylor, Eely, and McKenna 2017), provides questions to guide researchers when they gather people from similar backgrounds or experiences together to explore a specific issue of interest.

## **Data Analysis**

According to Eteng, O. 2022, data analysis is an important aspect of research because a poor analysis results in an incorrect report, which leads to inaccurate and poor decision-making. As a result, selecting an appropriate data analysis strategy is critical to obtaining reliable and meaningful insights from your data. Finding patterns, connections, and links in data can be difficult. Nonetheless, with the proper data analysis process and tools, it can run through its data and generate information about it.

### **Descriptive Statistics**

Descriptive statistics, according to Bhandari, 2023, are the qualities of a data collection that are organised and summarised using descriptive statistics. A data set is a collection of observations or responses from a subset of a population or the entire population. The first step in quantitative research statistical analysis is to describe the characteristics of the responses, such as the average of one variable (such as age) or the connection between two variables (such as age and creativity). One of the most common types of data analysis is descriptive analysis, which is well-known for producing intelligible insights from uninterpreted data. In contrast to other data analysis methodologies, descriptive analysis does not attempt to forecast the future. Instead, it simply employs changed historical data to make sense of it in order to draw conclusions.

### **Reliability Analysis**

In statistics, a metric's consistency is referred to as dependability. Researchers like tests with high dependability because it suggests that the results may be trusted because the test regularly provides measurements throughout time (Zach, 2022). The reliability analysis approach, in addition to giving data on the correlations between the scale's constituent items, generates a number of commonly used scale reliability measures. Intraclass correlation coefficients can be used to assess inter-rater dependability.

### **Pearson Correlation Analysis**

The Pearson Correlation Analysis was employed in this study. According to FlexMR (2021), correlation analysis is a statistical approach used to assess whether or not there is a link between two variables or datasets and the strength of that association. This means that in market research, correlation analysis is used to assess quantitative data obtained from research methodologies like as surveys and polls to see whether there are any noticeable links, patterns, or trends between the two.

The correlation coefficient, often known as Pearson's correlation coefficient, is a statistic that describes how strongly two variables are associated, according to Stewart, 2023. Pearson's correlation coefficient  $r$  has a range of -1 to +1. A value of 0 indicates that there is no connection between the two variables, but values of 1 or +1 indicate that there is a perfect linear relationship (Stewart, 2023). (Negative numbers simply indicate the direction of the relationship, with one variable growing while the other lowers.) Correlation coefficients that depart from 0 but are neither 1 nor +1 indicate a linear link, but not a totally linear one. The correlation coefficient was discovered in 1896 by British mathematician Karl Pearson, who expanded on previous studies by French physicist Auguste Bravais and British eugenicist Francis Galton (Stewart, 2023).

## **DATA ANALYSIS**

### **DEMOGRAPHIC CHARACTERISTICS OF RESPONDENTS**

An internet platform used to deliver 340 questionnaires in total. We intended for this survey to receive 280 responses, however we received 60 more than we expected. In that case, we used

340 respondents to create the SPSS. Below was a table with the total of questionnaires:

The total number of surveys distributed	340
Questionnaires returned and usable to be analysis	340
Response rate	100%
Questionnaires were utilised in the analysis	340

<i>Characteristics</i>		<i>Frequency</i>	<i>%</i>
	<b>Gender</b>	76	22.0
	<b>Male</b>	246	78.0
<b>Race</b>	<b>Female</b>	327	96.2
	<b>Malay</b>	5	1.5
	<b>Chinese</b>	2	0.7
	<b>Indian</b>	6	1.8
	<b>Others</b>	301	88.5
	<b>Age</b>	<b>20-30</b>	31
	<b>years old</b>	5	1.5
	<b>31-40 years old</b>	3	0.9
	<b>41-50 years old</b>	264	78
	<b>51 years old above</b>	76	22
<b>Marital Status</b>	<b>Single</b>	60	17.4
	<b>Married</b>	35	10.3
<b>Educational</b>	<b>Secondary School</b>	34	10.0
	<b>Form 6</b>	202	59.1
	<b>Diploma</b>	8	2.4
	<b>Bachelor of Degree</b>	1	0.3
	<b>Master Degree</b>	224	66.2
	<b>PhD</b>	78	22.6
<b>Occupation</b>	<b>Students</b>	37	10.9
	<b>Employed</b>	1	0.3

*Unemployed*

*Retired*

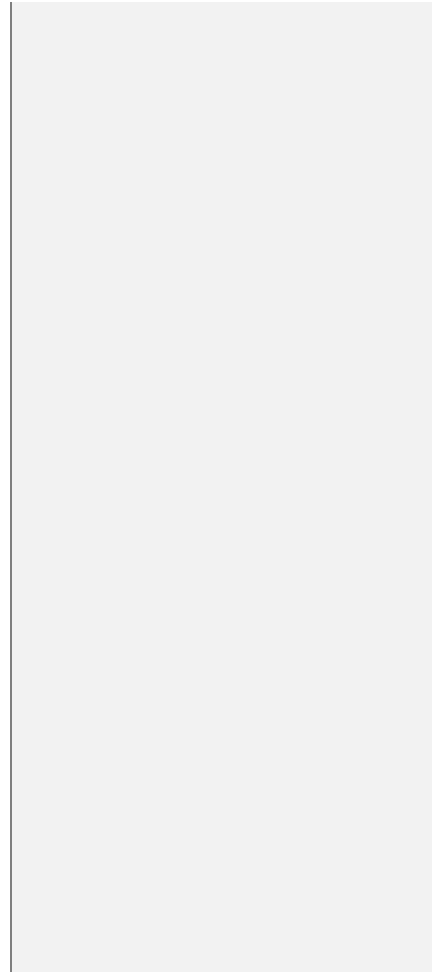

## **FINDINGS**

### **Demographic Profile of Respondent**

### **RESULT OF DESCRIPTIVE ANALYSIS**

Descriptive statistics are used to organise and summarise the features of data collected. A data set is a collection of observations or responses from a subset or the entire population (Bhandari, 2023). We utilised mean and standard deviation for the independent and dependent variables. The mean, or M, is the most often used method for computing the average. Simply add up all of the response values and divide the total by the total number of responses to get the mean. The total number of observations or answers is indicated by N. The standard deviation (s or SD) represents the average degree of variability in your dataset. It displays the average deviation from the mean of each score. The higher the standard deviation, the more unpredictable the data collection (Bhandari, 2023). The respondent's replies were rated using the Likert scale, with "Strongly Disagree" and "Disagree" being the options. "Neutral", "Agree", and "Strongly Agree"

Result of Descriptive Analysis Dependent Variable and Independent Variable

<i>VARIABLES</i>	<i>N</i>	<i>MEAN (M)</i>	<i>STANDARD DEVIATION (SD)</i>
<i>Re-visit Intention</i>	340	3.9725	.84407
<i>Atmosphere</i>	340	3.7953	.78510
<i>Culture Environment</i>	340	3.9447	.75571
<i>Destination Brand</i>	340	4.0512	.76399

A descriptive analysis of dependent and independent factors is shown in Table 4.8. The means and standard deviations of dependent and independent variables are shown in descriptive statistics. The highest mean in the table is 4.0512 (SD=.76399) for Destination Brand. The lowest mean in the table is 3.7953 (SD=.78510) for Atmosphere.

## RESULT OF RELIABILITY TEST

Reliability analysis can be used to evaluate the qualities of measuring scales and the items that comprise the scales. A number of frequently used scale reliability measures are computed by the reliability analysis technique, together with details on the correlations between particular scale items. Inter-rater reliability estimates can be computed using intraclass correlation coefficients (IBM Documentation, n.d.). According to the SPSS - Statistics How To, (2023), Cronbach's Alpha range by Interpretation if the alpha level is high, the test items may be significantly related. The 0.9 may be greater when there are more items, and the 0.5 may be lower when there are fewer items. If alpha is high, it may signal that more inquiries are required (Cronbach's Alpha: Definition, Interpretation, SPSS - Statistics How To, 2023b).

### Pilot Test

The researcher used a Google form to perform a pre-test to 33 respondents to ensure there were no grammatical problems, to see whether the respondents could understand the question, and to determine whether the claim was adequately presented. Source: SPSS

<i>Variables</i>	<i>Cronbach's Alpha</i>	<i>Number of Items</i>
<i>Revisit Intention</i>	0.670	5
<i>Atmosphere</i>	0.852	5

<i>Cultural Environment</i>	0.941	5
<i>Destination Brand</i>	0.956	5

### Reliability Test

<i>Variable</i>	<b>Cronbach's Alpha</b>	<b>No of item</b>	<b>N</b>
<i>Revisit Intention</i>	0.666	3	340
<i>Atmosphere</i>	0.904	5	340
<i>Cultural Environment</i>	0.920	5	340
<i>Destination Brand</i>	0.932	5	340
<i>All Variable</i>	0.957	18	340

### Reliability Analysis Result

The accuracy and repeatability reliability test has been completed. The survey was completed and replies were given by 340 random individuals. The survey's reliability analysis is provided in Table 4.15. The reliability of all constructs ranges between 0.666 and 0.932. Based on the findings of all the constructions, the coefficient is questionable and excellent. The results of this study show that destination brand has an exceptional construct value of 0.932, followed by cultural environment, which has an excellent construct value of 0.920, atmosphere at 0.904 (excellent), and finally re-visit intention at 0.666 (questionable).

### RESULT OF PEARSON'S CORRELATION COEFFICIENT ANALYSIS

Pearson's Coefficient of Correlation The relationship between the independent variables of atmosphere, cultural environment, and destination brand and the dependent variable of revisit intention was investigated using a coefficient analysis. The coefficient correlations and the intensity of the association are shown in the following table:



**Correlation Coefficient 'r' Strength Relationship**

$0.9 < r < 1$ or $-0.9 < r < -1$	Perfect
$0.7 < r < 0.9$ or $-0.7 < r < -0.9$	Strong
$0.5 < r < 0.7$ or $-0.5 < r < -0.7$	Moderate
$0.3 < r < 0.5$ or $-0.3 < r < -0.5$	Weak
$0.01 < r < 0.30$ or $-0.01 < r < -0.3$	Very Weak
0	Zero

**Hypothesis 1**

H1: There is a significance relationship between the atmosphere towards revisit intention at Tok Bali, Kelantan.

CORRELATIONS			
		Atmosphere	Revisit Intention
Atmosphere	Pearson Correlation	1	.624**
	Sig. (2-tailed)		< .001
	N	340	340
Revisit Intention	Pearson Correlation	.624**	1
	Sig. (2-tailed)	< .001	
	N	340	340

\*\*Correlation is significant at the 0.01 level (2-tailed)

A medium association between the atmosphere and revisit intention at Tok Bali, Kelantan, with a correlation value of .624\*\*. This demonstrates that the atmosphere has a good relationship with the revisit intention at Tok Bali, Kelantan. The significant value of the atmosphere is 0.000, which is less than the highly significant value of 0.001. As a result, there is a relationship between the atmosphere towards revisit intention at Tok Bali, Kelantan. H1 is therefore supported.

### Hypothesis 2

H2: There is a significance relationship between the cultural environment towards revisit intention at Tok Bali, Kelantan.

CORRELATIONS			
		Cultural Environment	Revisit Intention
Cultural Environment	Pearson Correlation	1	.590**
	Sig. (2-tailed)		< .001
	N	340	340
Revisit Intention	Pearson Correlation	.590**	1
	Sig. (2-tailed)	< .001	
	N	340	340

\*\*Correlation is significant at the 0.01 level (2-tailed)

Demonstrates that there is a .590\*\* association between cultural environment and revisit intention in Tok Bali, Kelantan. This shows a relationship between the cultural environment and revisit intention at Tok Bali, Kelantan. The significant value for the cultural environment is 0.000, which is less than the significant level of 0.01. As a result, there is a substantial association between the cultural environment towards revisit intention at Tok Bali, Kelantan. H2 is therefore supported.

### Hypothesis 3

H3: There is a significance relationship between the destination brands towards revisit intention at Tok Bali, Kelantan.

CORRELATIONS			
--------------	--	--	--

		Destination Brand	Revisit Intention
<b>Destination Brand</b>	Pearson Correlation	1	.652**
	Sig. (2-tailed)		< .001
	N	340	340
<b>Revisit Intention</b>	Pearson Correlation	.652**	1
	Sig. (2-tailed)	< .001	
	N	340	340

\*\*Correlation is significant at the 0.01 level (2-tailed)

The correlation value of .652\*\* reveals a medium relationship between the destination brands towards revisit intention at Tok Bali, Kelantan. This shows that the relationship between the destination brands towards revisit intention at Tok Bali, Kelantan. The significant value of the destination brand is 0.000, which is below the highly significant value of 0.001. H3 is therefore supported.

## DISCUSSION BASED ON RESEARCH OBJECTIVES

The findings of this study examined the relationship between the atmosphere, cultural environment, destination brand, and revisit intention at Tok Bali, Kelantan.

Hypothesis	Pearson's Correlation Results
H1: There is a significance relationship between the atmosphere towards revisit intention at Tok Bali, Kelantan.	r = .624**, p < 0.01 Medium
H2: There is a significance relationship between the cultural environment towards revisit intention at Tok Bali, Kelantan.	r = .590**, p < 0.01 Medium
H3: There is a significance relationship between the destination brands towards revisit intention at Tok Bali, Kelantan.	r = .652**, p < 0.01 Medium

According to table, Pearson's correlation analysis was used to evaluate the hypothesis on atmosphere, cultural environment, destination brand, and revisit intention in Tok Bali, Kelantan. All hypotheses were accepted at the 0.01 significance level. Furthermore, the end result demonstrated that the independent factors of atmosphere, cultural environment, and destination brand have a medium and positive link with the intention to visit again.

## **RECAPITULATION OF THE FINDINGS**

The results presented in Chapter 4 are based on a questionnaire created by the researchers and administered to the respondents. The questionnaire has a total of 20 questions across all parts. Section A focuses on the respondents' demographic information, which includes their gender, race, age, marital status, and occupation. The atmosphere, cultural environment, and destination brand were the independent variables (IV) discussed in Section B. Section C concentrated on the dependent variable (DV), which is the revisit intention in Tok Bali, Kelantan from a tourist standpoint. The questionnaire focuses on the quantitative character of descriptive science and has several alternatives for respondents to fill out.

### **Relationship between atmosphere and revisit intention of community-based tourism in Tok Bali, Kelantan.**

In order to respond to research question 1, the results of hypothesis H1 in the prior chapter were examined. In addition, H1 said that in Tok Bali, Kelantan, there is a connection between the mood and visitors' intentions to return. According to the results, there is a favourable atmosphere and a moderate relationship between community-based tourism intentions for repeat visits in Tok Bali, Kelantan, with a correlation value of.624. The atmosphere's p value is.000, which is below the extremely significant level of.0001. In Tok Bali, Kelantan, there is a connection between the mood and visitors' intentions to return. H1 accepted.

### **Relationship between cultural environment and revisit intention of community-based tourism in Tok Bali, Kelantan.**

The findings of hypothesis H2 in the previous chapter was reviewed in order to answer research question 2. In addition, H2 said that there was a connection between the cultural setting and the ambition of community-based tourism in Tok Bali, Kelantan, to return. According to the findings, cultural environment is positively and significantly associated to community-based tourism return intention in Tok Bali, Kelantan, with a correlation value of.590. Place attachment has a p value of.000, which is below than the.001 level of statistical significance. Additionally, in Tok Bali, Kelantan, there is a connection between the cultural context and the intention to return. As a result, H2 accepted.

### **Relationship between destination brand and revisit intention of community-based tourism in Tok Bali, Kelantan.**

To respond to research question 3, it was necessary to evaluate the outcome of hypothesis H3, which was presented in the preceding chapter. In addition, H3 reported that in Tok Bali, Kelantan, there is a connection between the destination brand and the inclination to return. According to the results, destination brand is positively and modestly associated with the desire of returning to Tok Bali, Kelantan's community-based tourism, with a correlation coefficient of.652. Place attachment has a p value of.000, which is below than the.001 level of statistical significance. Additionally, there is a

connection between the destination brand and the intention to return in Tok Bali, Kelantan. As a result, H3 accepted.

## **LIMITATIONS**

A beneficial and crucial method to complete the research was experienced throughout the full investigation. Even yet, there are several constraints that cannot be avoided by proceeding with the research as planned. It is important to be aware of the restrictions on the current study. The first restriction of this study is the lengthy timeline required to complete the entire data gathering. The researcher attempted to gather responses as rapidly as possible. Furthermore, respondents' unwillingness to cooperate in answering the online questionnaire. It is difficult for researchers to discover visitors who visit Tok Bali, Kelantan on a regular basis in order to conduct an appropriate study. Online questionnaires spread via WhatsApp groups, Facebook pages, and Instagram gained little answers. To encourage respondents to complete out the survey, the researcher had to continuously ask and appeal to them.

## **RECOMMENDATIONS**

This work still needs to be improved for future research. As a result, certain recommendations have been created to be utilised in future research in order to improve the output. The first recommendation is that this study be conducted utilising both qualitative and quantitative methodologies. This is because it can help researchers obtain more accurate and high-quality results in the future. Following that, if survey questions are given online, researchers must do it in a more official manner. Furthermore, the surveys must be accompanied by a letter of confirmation from the institution or superiors in order to perform the study. As the survey is included with the confirmation letter, this ensures that respondents trust and do not hesitate to answer the surveys provided.

When it comes to the function of perceived advantages in revisit intention, perceived benefits play a significant part in tourist decision making. Future research should look into the influence of perceived advantages including cultural immersion, social interaction, and environmental sustainability on the desire to return to Tok Bali community-based tourism. Furthermore, for future studies, researchers might study the impact of tourist motive on return intention, the function of trust in revisit intention, and the impact of information sources on revisit intention.

In conclusion, this study was conducted to investigate variables influencing the return intention of community-based tourism in Tok Bali, Kelantan: the tourist perspective. The important characteristics (independent variables) of the atmosphere, cultural environment, and destination brand have an influence on visitors' revisit intention (dependent variable) in Tok Bali, Kelantan. As described in Chapter 3, researchers used Google Forms with 342 respondents to deliver surveys to those who go

to and visit Tok Bali. The researcher also gathers all data and information using a quantitative technique. The researcher also used Google Forms to connect with folks from all throughout Kelantan.

The Statistical Package for the Social Science (SPSS) software was then used to analyse the data from the questionnaire and the conclusions gathered in the previous chapter. The software was used by the researchers since it made it simple to obtain all the results. The next step is to summarise the data and decide the final result. For this investigation, all three of the offered hypotheses H1, H2, and H3 are accepted. Furthermore, limits and suggestions were developed for this study, which we think would be useful in future research. As a result, it is hoped that all of the material presented during this research will be useful to the next researcher.

## REFERENCES

- Akter, M., Sadekin, M. N., & Patwary, A. K. (2020). An Empirical Study on Students' Satisfaction from Mawlana Bhashani Science & Technology University, Bangladesh. *Review of Economics and Development Studies*, 6(2), 363-379.
- Alom, S., Patwary, A. K., & Khan, M. M. H. (2019). Factors affecting the turnover intention of Bangladeshi migrants in the United Arab Emirates: An empirical study on the hotel industry. *International Journal of Innovation, Creativity and Change*, 8(3), 344-360.
- Bagus, S. I., Imade, S. U., Nyoman, S. I. A., & Putu, W. S. N. (2019). Community based tourism as sustainable tourism support. *Russian Journal of Agricultural and Socio- Economic Sciences*, 94(10), 70-78.
- Bauer H. H., Sauer N. E., Exler S. (2005). The loyalty of German soccer fans: Does a team's brand image matter? *International Journal of Sports Marketing and Sponsorship*, 7(1), 14-22. <https://doi.org/10.1108/IJSMS-07-01-2005-B004>
- Bhandari, P. (2023b). Descriptive Statistics | Definitions, Types, Examples. *Scribbr*. <https://www.scribbr.com/statistics/descriptive-statistics/>
- Bush, T. (2020, June 22). Descriptive Analysis: How-To, Types, Examples. *PESTLE Analysis*. <https://pestleanalysis.com/descriptive-analysis/>
- Chan, S. (2018). Factors Affecting Revisit Intention With Customer Satisfaction As a Mediating Variable in Eco Friendly Resorts. *Jurnal Manajemen Inovasi*, 9(1).
- Cheng, T. M., & Chen, M. T. (2021). Creative Atmosphere in Creative Tourism Destinations: Conceptualizing and Scale Development. *Journal of Hospitality & Tourism Research*, 109634802110124. <https://doi.org/10.1177/10963480211012459>
- Chin, C. H., & Lo, M. C. (2017). Rural tourism quality of services: Fundamental contributive factors from tourists' perceptions. *Asia Pacific Journal of Tourism Research*, 22(4), 465-476.
- Cronbach's Alpha: Definition, Interpretation, SPSS - Statistics How To*. (2023b, March 3). Statistics How To. <https://www.statisticshowto.com/probability-and-statistics/statistics-definitions/cronbachs-alpha-spss/>
- Eteng, O. (2022, December 29). *Quantitative Data Analysis: Methods & Techniques Simplified 101*. Learn | Hevo.

- Fengmin, Z., Baijun, W., Jiangtao, B., Li, L., & Patwary, A. K. (2022). Investigating revisit intention of medical tourists in China through nutritional knowledge, perceived medical quality, and trust in the physiologist: A recommendation on health tourism policy measures. *Frontiers in Public Health*, 10, 893497.
- FlexMR. (2021, December 10). What is Correlation Analysis? Definition and Exploration. *Medium*. <https://flexmr.medium.com/what-is-correlation-analysis-definition-and-exploration-cc61bf405899>
- Geoforum 2014, 51, 213–223
- Giampiccoli, A.; Dłużewska, A.; Mnguni, E.M. Host Population Well-Being through Community-Based Tourism and Local Control: Issues and Ways Forward. *Sustainability* 2022, 14, 4372.
- Hazbar, A. M. H., Alem Mohammed, A., & Karim, A. K. A. (2019). An Empirical Study of Factors Influencing hotel customers' online booking Intention. *مجلة العلوم التربوية و الدراسات الإنسانية*, (5), 1-17.
- Heide M., Grønhaug K. (2006). Atmosphere: Conceptual issues and implications for hospitality management. *Scandinavian Journal of Hospitality and Tourism*, 6(4), 271-
- Hill, E. (2022, May 8). *What is cultural environment and examples?* Answers-List.
- Huang, S., & Hsu, C. H. (2009). Effects of travel motivation, past experience, perceived constraint, and attitude on revisit intention. *Journal of travel research*, 48(1), 29-44. <https://doi.org/10.1177/0047287508328793>
- IBM Documentation. (n.d.). <https://www.ibm.com/docs/en/spss-statistics/25.0.0?topic=features-reliability-analysis>
- INTENTION: TOURISTS PERSPECTIVE. *International Journal of Business and Society*, 20(2), 585-604.
- Isa, S. M., Ariyanto, H. H., & Kiumarsi, S. (2019). The effect of place attachment on visitors' revisit intentions: evidence from Batam. *Tourism Geographies*.
- Jee, T. W., Ting, H. B., & Alim, M. A. (2019). COMMUNITY BASED TOURISM REVISIT
- Juma, L. O., & Khademi-Vidra, A. (2019). Community-based tourism and sustainable development of rural regions in Kenya; Perceptions of the citizenry. *Sustainability*, 11(17), 4733.
- kelantan. SAYS.
- Kline, C., McGehee, N., & Delconte, J. (2019). Built capital as a catalyst for community- based tourism. *Journal of Travel Research*, 58(6), 899-915.
- Kotler, P. (1973). Atmosphere as a marketing tool. *Journal of Retailing*, 49, 48-64
- Heide, M. & Grønhaug, K. (2006). Atmosphere: conceptual issues and implications for hospitality management. *Scandinavian Journal of Hospitality and Tourism*, 6(4), 271-86.
- Li, L., Ragavan, N. A., Patwary, A. K., & Baijun, W. (2022). Measuring patients' satisfaction toward health tourism in Malaysia through hospital environment, nutritional advice, and perceived value: A study on Chinese exchange students. *Frontiers in public health*, 10, 893439.
- Li, L., Wu, B., & Patwary, A. K. (2022). How marine tourism promote financial development in sustainable economy: new evidences from South Asia and implications to future tourism students. *Environmental Science and Pollution Research*, 29, 1155-1172.
- Li, L., Wu, B., & Patwary, A. K. (2022). The psychosocial factors affecting chinese Outbound Exchange and mobility students' academic performance during COVID-19. *Frontiers in psychology*, 13, 872516.
- Mehta, R. (2022, December 29). Cultural Environment - Meaning, Importance, Components and Example. Digiaide.com. <https://digiaide.com/cultural-environment/>

- Mohd Salleh, N. H., & Abdul Halim, M. A. (2018). Enhancing environmental sustainability over fisheries industry through proactive risk evaluation: A case. . . *ResearchGate*. [https://www.researchgate.net/publication/326016609\\_Enhancing\\_environmental\\_sustainability\\_over\\_fisheries\\_industry\\_through\\_proactive\\_risk\\_evaluation\\_A\\_case\\_of\\_Tok\\_Bali\\_fishing\\_port](https://www.researchgate.net/publication/326016609_Enhancing_environmental_sustainability_over_fisheries_industry_through_proactive_risk_evaluation_A_case_of_Tok_Bali_fishing_port)
- Patwary, A. K., Roy, B., Hoque, R., & Khandakar, M. S. A. (2019). Process of developing a community based tourism and identifying its economic and social impacts: An Empirical study on Cox's Bazar, Bangladesh. *Pakistan Journal of Humanities and Social Sciences*, 7(1), 1-13.
- Podsakoff, P. M., MacKenzie, S. B., & Podsakoff, N. P. (2012). Sources of method bias in social science research and recommendations on how to control it. *Annual Review of Psychology*, 65, 539-569.
- Qistina, N. (2022). Locals are shocked at the current state of tok bali beach in
- Richards G. (2011). Creativity and tourism: The state of the art. *Annals of Tourism Research*, 38(4), 1225-1253. <https://doi.org/10.1016/j.annals.2011.07.008>
- Rudolf, W.; Wæraas, A. Municipal Branding and Social Media: Comparing Poland, Norway, and Ukraine. In *Public Branding and Marketing: A Global Viewpoint*; Zavattaro, S.M., Ed.; Springer International Publishing: Cham, Switzerland, 2021; pp. 79–115
- Slåtten, T., Mehmetoglu, M., Svensson, G. & Sværi, S. (2009). Atmospheric experiences that emotionally touch customers: A case study from a winter park. *Managing Service Quality*, 19(6), 721-746.
- Soini, K.; Birkeland, I. Exploring the scientific discourse on cultural sustainability.
- Sumethokula, P., Patwary, A. K., Srinuanpanc, B., Srinuanpand, C., Suwandee, P., Thammathikul, A., & Phanong, W. (2020). The potential of new tour repackaging for creative tourism among entrepreneurs in Nakhon Si Thammarat. *International Journal of Innovation, Creativity and Change*, 13(10), 1752-1771.
- Tasci, A.D.A.; Kozak, M. Destination brands vs destination images: Do we know what we mean? *J. Vacat. Mark.* 2006, 12, 299–317.
- Thant, M. (2020, August 18). What is Community Based Tourism (and Why Does It Matter?). Pro Niti - Myanmar Tour Operator for Adventure & Luxury Experience.
- Uhrich S., Benkenstein M. (2010). Sport stadium atmosphere: Formative and reflective indicators for operationalizing the construct. *Journal of Sport Management*, 24(2), 211-
- Um, S., Chon, K., & Ro, Y. (2006). Antecedents of revisit intention. *Annals of Tourism Research*, 33(4), 1141–1158. <https://doi.org/10.1016/j.annals.2006.06.003>
- Verma, A. (2022, February 7). *What Is Destination Branding? (Benefits Of Community's Marketers)*. 76 Degree Creative.
- Verma, D. (2015b, December 18). *4 Different Perspectives of Tourism Identified by McIntosh and Goeldner*. World's Largest Collection of Essays! Published by Experts.
- Wu, B., Liu, S., Wang, J., Tahir, S., & Patwary, A. K. (2021). Assessing the mechanism of energy efficiency and energy poverty alleviation based on environmental regulation policy measures. *Environmental Science and Pollution Research*, 28, 40858-40870.
- Wu, B., Zhai, B., Mu, H., Peng, X., Wang, C., & Patwary, A. K. (2021). Evaluating an economic application of renewable generated hydrogen: A way forward for green economic performance and policy measures. *Environmental Science and Pollution Research*, 1-15.
- Yanes, A.; Zielinski, S.; Diaz Cano, M.; Kim, S.-i. Community-Based Tourism in Developing Countries: A Framework for Policy Evaluation. *Sustainability* 2019, 11, 2506.



- Zach. (2022). What is Reliability Analysis? (Definition & Example). *Statology*. <https://www.statology.org/reliability-analysis/>
- Zhang, Y., Xiong, Y., Lee, T. J., Ye, M., & Nunkoo, R. (2021). Sociocultural Sustainability and the Formation of Social Capital from Community-based Tourism. *Journal of Travel Research*, 60(3), 656–669.
- Zielinski, S., Jeong, Y., Kim, S. I., & B. Milanés, C. (2020). Why community-based tourism and rural tourism in developing and developed nations are treated differently? A review. *Sustainability*, 12(15), 5938.

# THE IMPACT OF SERVICE QUALITY AIRQUAL MODEL TOWARDS MALAYSIA AIRLINES CUSTOMERS' SATISFACTION

*Nur Syamiera Najwa Binti Napiza, Nur Syazwani Binti Alin, Nur Syazwina Ezzwin  
Binti Hamiruddin, Nur 'Ain 'Adilah Binti Che Zahir &*

*\*Nurul Aziah Binti Ahmad\**

*Faculty of Hospitality, Tourism and Wellness, Universiti Malaysia  
Kelantan Corresponding email: [nurulaziah@umk.edu.my](mailto:nurulaziah@umk.edu.my)*

---

## ABSTRACT

*The purpose of this paper is to discuss how passengers' satisfaction with quality services supplied by airlines can be quantified using the AIRQUAL technique. A quantitative study was conducted to identify airline tangibles, Terminal tangible, and personnel service among the airline passengers the company improves to the service quality of the airlines. The researcher administered 384 responses using a convenience sample of Malaysia Airlines passengers. The outcomes of this study will assist Malaysia Airlines in redefining its marketing approach to one that is more focused on passengers and emphasizes airline service quality.*

**Keywords:** Malaysia Airlines, customers satisfaction, terminal tangible, Airlines tangible, personnel.

---

## INTRODUCTION

Tourism is the third-largest sector in the world, with domestic, inbound, and outbound tourism being the three categories. The air transportation sector is an important industry that supports tourism, with the global airline industry transporting 2.7 billion passengers yearly. Malaysia Airlines is the nation's national airline, providing insurance and compensation to passengers in the event of a fatality or other accident. Next, the importance of airlines in the tourism industry is to increase their profits. Tourists will use airplanes to go to destinations such as vacations abroad or domestically. Furthermore, during school holidays or festivals, airline demand will rise. Apart from that, tourists will purchase flight tickets when airlines offer them at low prices. After that, airlines will provide insurance and compensation to passengers in the case of a fatality or other accident, including pilot carelessness, take-off damage, crashes, or other occurrences. Malayan Airways Limited, which was founded in 1947, made its first commercial flight in 1947. In 1963, the year the Federation of Malaysia was created, it was renamed Malaysian Airways. The airline was renamed Malaysia Singapore Airlines (MSA) in 1966 and Malaysian Airline System (MAS) in 1972.

Several objectives of this study were established as follows:

1. To examine the relationship between airline's tangible towards customer satisfaction using Malaysia Airlines.
2. To examine the relationship between terminal tangible towards customer satisfaction using Malaysia Airlines.
3. To examine the relationship between personnel services towards customer satisfaction using Malaysia Airlines.

## **SIGNIFICANCE OF THE STUDY**

The findings of this study are predicted to be significant in tourists' satisfaction with Malaysia Airlines flight services. In addition, this study is expected to help various parties who want to conduct studies in the future related to satisfaction with Malaysia Airlines flight services. The Malaysia Airlines aviation industry sector will be able to grow if we can find a way to deal with the issues faced by customers who use Malaysia Airlines. Practically, it can be useful to various individuals, including customers, pilots, co-pilots, and cabin crew. The following is an example of a hypothetical research scope, with the research question being "How satisfied are customers with Malaysia Airlines services?" We were also informed that the questionnaire was the tool used to evaluate any changes in this investigation. Any other approach is beyond the scope of the research and may constitute a limitation of the study. This is a clear statement of how the outcome measures will be explored.

## **LITERATURE REVIEW**

### **Service Quality**

Refer to the Indeed Editorial Team (2022) article. Service quality is a measure of how successfully a company satisfies its customers' requirements and expectations. Customers purchase services to satisfy specific needs. Whether people are aware of it or not, customers have criteria and expectations for how a business's service delivery fits their needs. A company that delivers outstanding service quality meets or exceeds its customers' expectations.

### **Airline tangible**

The term "airline tangible" refers to the physical indications of an airline's degree of customer service. (2006) (Ekiz and colleagues). It is widely acknowledged as one of the most essential aspects of service quality in the aviation industry. Gudmundsson (1998) and Farooq (2016) According to Ali et al. (2015), airline tangible refers to the total state of an aircraft, which includes the quality of its components the equipment both inside and out, the grade of the meals, the comfort of the seating, and cleanliness.

## **Terminal tangible**

According to Arifin and Yahaya (2013), one of the most visible indicators of an airline's service excellence is its final tangibles. Terminal tangible has a direct impact on the overall image of the airline. The terminal's tangible nature signifies the terminal's service quality. (2006) (Ekiz et al.). Effective sign boards, a pleasant security and control system, a nice cooling system in the airport, clean toilets, and assistance desks for passenger advice are among the amenities provided. Wu and Cheng, 2013; Ali et al., 2015).

## **Personnel services**

Personnel services are an important part of the total customer experience provided by an airline. Nadiri et al., 2008. It refers to the level of customer service offered by airline personnel, particularly flight attendant attitudes and practises in customer care. Boetsch et al., 2011; Ekiz et al., 2006). Additionally, human services include error-free ticketing, flight staff response, personal hygiene, and a pleasant attitude. Namukasa, 2013.

## **Customer Satisfaction**

The good experience that travelers get after visiting the locations is termed customer satisfaction. Khan and colleagues (2013). When the experience of a guest exceeds their expectations, they are satisfied. (Deng and Pierskalla, 2011). Satisfied customers are the most important factor in purchase intent and loyalty (Kotler, 2000). One of the most regularly obtained elements of marketing outcomes is customer satisfaction statistics. The collecting, investigation, and distribution of this information inside companies reveal something particular about the importance of keeping track of consumers and guaranteeing that they have a favorable participation in the goods of the company and endeavors. Kotler (2000)

## **Research Hypothesis**

The study's hypothesis is to see if there are any correlations or links between dependent variables and independent variables:

**H1:** There is a significant relationship between airlines' tangible toward customer satisfaction using Malaysia Airlines.

**H2:** There is a significant relationship between terminal tangible towards customer satisfaction using Malaysia Airlines.

**H3:** There is a significant relationship between personnel services towards customer satisfaction using Malaysia Airlines.

## Research Framework

Figure 1 below shows the research framework used for this study.

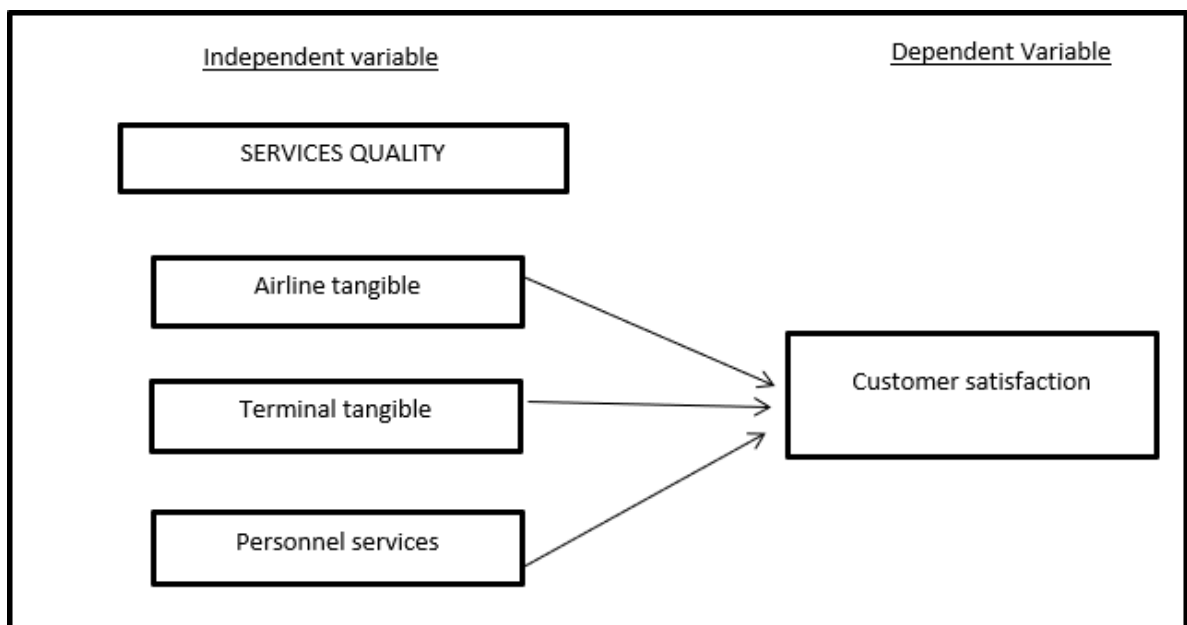

**Figure 1: Conceptual framework**

## METHODOLOGY

### Research Design

The research design refers to the overall approach taken in a study to address predetermined research questions through data gathering, interpretation, analysis, and presentation. It aims to produce results while minimizing variance. Quantitative research involves the measurable investigation of numerical data using methods like surveys and questionnaires. This study

employs a causal research design to identify the cause-and-effect relationship between variables and how they impact existing criteria and assumptions. A cross-sectional study design is used, which gathers information at a single point in time and focuses on identifying correlations between variables. Cross-sectional designs often utilize surveys due to their efficiency and cost-effectiveness. The unit of analysis in this study is the passenger customers of Malaysia Airlines. Surveys are the preferred method for data collection, and Google Forms is used to administer self-administered questionnaires online. This approach allows for an easy assessment of customer satisfaction with Malaysia Airlines' services.

To collect information from this large population, surveys are used. The population's participation is crucial in achieving the research objectives, particularly in examining the satisfaction levels among students and workers in Kota Bharu, Kelantan. The number of participants involved in the study is referred to as the sample size. To ensure a representative sample, proper sampling methods and satisfactory responses are required. In this study, the researcher follows the model proposed by Krejcie and Morgan (1970). Based on this model, the sample size is determined by the population of Malaysia, which is approximately 32.78 million. Thus, a sample size of 384 respondents will be selected and surveyed to represent the population.

### **Data Collection**

Data collection is a crucial process for obtaining comprehensive and reliable information from numerous sources. It enables individuals or organisations to address pertinent topics, analyse results, and forecast future trends. In this study, questionnaires were employed to collect data. method through a survey. Questionnaires involve respondents answering a series of standardized questions. This approach is often cost-effective and easier to manage compared to other methods. Additionally, due to the large number of participants involved in this study, the researchers opted for questionnaires as an efficient means of gathering data and information.

### **Sampling**

Sampling designs in research there are two forms of sampling: non-probability sampling and probability sampling. Sampling without regard for probability involves selecting individuals from the population without a known probability of being chosen, while probability sampling ensures that elements in the population are selected based on known probabilities. To pick respondents for this study, a non-probability sampling strategy, namely simple sampling procedures, was used from the population of Malaysia Airlines. This sampling strategy was considered suitable for the investigation. To ensure ethical practices and maintain neutrality, a comprehensive ethical strategy was employed during the data collection process. Convenience sampling was used to select participants who were willing and able to take part in the survey. This method allows for the selection of respondents based on their availability and willingness to participate.

### **Data Analysis**

Researchers will use the program Statistical Programmers for Social Science (SPSS) version 28 to examine the primary data. SPSS is a program-based data processing and analysis window that allows you to create tables and pie charts. Computers aided researchers in lowering the effort required to determine the information and making quantitative analyses easily and quickly. The researcher evaluates quantitative data using descriptive statistics, reliability statistics, Pearson's correlation, and regression.

## FINDINGS

Demographic Profile Respondents:

Demographic	Categories	Frequency (N)	Percentage (%)
<b>Age</b>	18 - 22 years	84	21.9
	23 - 27 years	249	64.8
	28 - 32 years	28	7.3
	33 years and above	23	6.0
<b>Gender</b>	Male	99	25.8
	Female	285	74.2
<b>Race</b>	Malay	351	91.4
	Indian	11	2.9
	Chinese		
	Others	10	2.6
		12	3.1

<b>Marital Status</b>	Single	336	87.5
	Married	48	12.5
<b>Education Level</b>	Secondary School	18	4.7
	Diploma	39	10.2
	Bachelor of Degree	312	81.3
	Master's Degree Doctor of Philosophy	14	3.5
		1	.3
<b>Occupation</b>	Government	44	11.5
	NGO	21	5.5
	Self-employed	19	4.9
	Unemployed	9	2.3
	Student Retired	286	74.5
		5	1.3

**Table 1: Demographic Profile**

Table 1 presents the age distribution of the respondents, with a total of 384 participants. The respondents are divided into four age groups: 18–22 years old, 23–27 years old, 28–32 years old, and 33 years old and above. The largest group consists of respondents aged 23–27 years, accounting for 64.8% (249 respondents). The second-largest group is aged 18–22 years, comprising 21.9% (84 respondents), followed by the 28–32 years group with 7.3% (28



respondents). The smallest group is 33 years and older, representing only 6.0% (23 respondents).

Meanwhile, for gender distribution, female respondents account for 74.2% (285 respondents), while male respondents make up 25.8% (99 respondents). Thus, there is a higher proportion female respondent outnumbers to male respondents.

The racial distribution among the respondents shows that the majority, 91.4% (351 respondents), belong to the Malay race. Other races account for 3.1% (12 respondents), with Indian respondents comprising 2.9% (11 respondents) and Chinese respondents comprising 2.6% (10 respondents).

Regarding marital status, the majority of respondents are single, making up 87.5% (336 respondents), while married respondents constitute 12.5% (48 respondents).

As for the level of educational background, the majority of respondents, 81.3% (312 respondents), have a bachelor's degree. The second-highest educational level is diploma, with 10.2% (39 respondents), followed by secondary school at 4.7% (18 respondents). A small percentage of respondents have a master's degree, accounting for 3.5% (14 respondents), while only one respondent, representing 0.3%, holds a Ph.D.

In terms of occupation, the largest group of respondents consists of students, accounting for 74.5% (286 respondents). Government employees represent 11.5% (44 respondents), while respondents working in non-governmental organizations (NGOs) constitute 5.5% (21 respondents). Self-employed individuals make up 4.9% (19 respondents), while the unemployed represent 2.3% (9 respondents). The smallest group consists of retired individuals, accounting for 1.3% (5 respondents).

## RESULT OF DESCRIPTIVE ANALYSIS

Variable	Items	N	Means	Standard Deviation
<b>Airlines Tangible</b>	Aircraft are safe and clean	384	4.22	.780
	The quality of catering served on the plane is good	384	4.08	.796
	Plane toilets are clean	384	4.11	.779

	Plane seats are clean	384	4.22	.795
	Plane seats are comfortable	384	4.08	.873
	Quality of air conditioning in the planes are good	384	4.20	.798
	Up to date newspaper, magazines and video films are available during the flight	384	4.04	.883
<b>Terminal Tangible</b>	Ground staff are very helpful	384	3.72	.886
	Malaysia Airlines employees are consistently courteous	384	3.75	.883
	Check-in procedures are efficient	384	3.77	.862
	The airport has effective and advance system	384	3.86	.902
	Airport facilities are very clean	384	3.84	.849
	Baggage handling is quick	384	3.84	.849
	Terminal announcements at Kuala Lumpur	384	3.84	.849

	International Airport are very clear			
	Provide security procedures (for persons & Luggage)	384	3.84	.849
<b>Personnel</b>	Employees' general attitude is good	384	4.06	.729
	Airline personnel give exact answers to your questions	384	4.07	.730
	Personnel show personal care equally to everyone	384	4.08	.757
	Employees have the knowledge to answer your question.	384	4.21	.687
	The airlines personnel show empathy	384	4.13	.732
	Airlines personnel are aware of their duties	384	4.21	.702
	Reservations and ticketing transactions are error-free	384	4.09	.737
<b>Customer Satisfaction</b>	I feel that my experience with Malaysia Airlines has been enjoyable	384	4.12	.784
	Feeling satisfied with	384	4.15	.769

	the services provided by Malaysia Airlines			
	My choice of Malaysia Airlines as a service provider was a wise one	384	4.14	.773
	I now have a more positive attitude towards the company Malaysia Airlines	384	4.18	.768
	Overall, I feel satisfy with Malaysia Airlines	384	4.17	.801

**Table 2: Result of Descriptive Analysis**

Table 2 displays the mean and standard deviation of the dependent and independent variables in this study. Question 1 and 4 yielded the highest mean value for the dependent variable, 4.22 (SD= 0.780 and 0.795), indicating that respondents agreed that aeroplanes and airline seats are safe and clean. The lowest mean score was 3.72 (SD= 0.886) for Question 1, indicating that respondents believed Malaysia Airlines' ground workers were really helpful. People received the highest mean score, 4.21 (SD= 0.687 and 0.702), suggesting that respondents thought Malaysia Airlines workers knew how to answer passenger questions and were aware of their responsibilities. The lowest mean score for Question 1 was 4.12 (SD= 0.784), indicating that respondents enjoyed their experience with Malaysia Airlines. Question 4 had the highest significant mean value of 3.86 (SD= 0.902) for the independent variable of terminal tangible, indicating that respondents thought the airport had a modern and efficient system.

## RESULT OF THE RELIABILITY TEST

According to Creswell and Creswell (2017) and (2013), reliability analysis is increasingly being utilised to assess measurement internal consistency. Internal consistency refers to the degree to which any indication of a concept appears to function consistently at a few fundamental levels. Researchers accept Cronbach's alpha values of 0.70 and above. Cronbach's alpha is a test reliability metric. Researchers have the ability to recognise.

Construct	Cronbach's Alpha	No of Item	N
Airlines Tangible	0.936	7	31
Terminal Tangible	0.985	8	31
Personnel	0.946	7	31
Customer Satisfaction	0.980	5	31
<b>All Variable</b>		<b>27</b>	<b>31</b>

**Table 3: Pilot Test Result**

The dependability of four components is shown in the table below. Cronbach's Alpha was used to analyse the consistency of the 27 questions used to test five distinct domains. The coefficients of all buildings range from good to remarkable, according to data. Furthermore, the result is larger than 0.7, suggesting that the questionnaire may be sent and the survey can proceed.

According to statistics, customer satisfaction has the highest coefficient, with a reliability testing result of 0.980 (excellent), and terminal tangible has an extraordinary grade of 0.985. Meanwhile, the tangible and personnel coefficients of the airline have been 0.936 and 0.946, respectively (excellent).

## PEARSON CORRELATION

### Hypothesis 1

H1: There is a significant relationship between airlines' tangible toward customer satisfaction using Malaysia Airlines.

CORRELATIONS			
		Service Quality	Tourist Satisfaction
Service Quality	Pearson Correlation	1	.710
	Sig. (2-tailed)		.000
	N	384	384
Tourist Satisfaction	Pearson Correlation	.710	1
	Sig. (2-tailed)	.000	
	N	384	384

\*\*Correlation is significant at the 0.01 level (2-tailed)

**Table 4: Correlation Analysis for Hypothesis 1**

Table 4 shows a 0.710 significant correlation between major airlines and customer satisfaction, which influences consumer delight when flying with Malaysia Airlines. This indicates a link between airline tangibles and Malaysia Airlines customer satisfaction. The significance of the airline is 0.000, which is less than the significance of 0.001. As a result, there is a strong link between airline tangibles and consumer happiness, which has an influence on customer pleasure when travelling with Malaysia Airlines. As a consequence, H1 is suitable.

## Hypothesis 2

**H2: There is a significant relationship between terminal tangible towards customer satisfaction using Malaysia Airlines.**

CORRELATIONS			
		Motivation	Tourist Satisfaction
Motivation	Pearson Correlation	1	.764
	Sig. (2-tailed)		.000
	N	384	384
Tourist Satisfaction	Pearson Correlation	.764	1
	Sig. (2-tailed)	.000	

	N	384	384

\*\*Correlation is significant at the 0.01 level (2-tailed)

**Table 5: Correlation Analysis for Hypothesis 2**



Table 5 shows that there is a 0.764 correlation between terminal tangibles and customer happiness, which influences consumer pleasure when flying with Malaysia Airlines. This implies that the link between terminal tangibles and customer satisfaction is rather robust and well-established among Malaysia Airlines customers. The terminal tangible has a significant value of 0.000, which is less than the 0.01 required. As a result, there is a strong link between terminal tangibles and consumer pleasure while flying with Malaysia Airlines. As a consequence, H2 may be used again.

**Hypothesis 3**

**H3: There is a significant relationship between personnel services towards customer satisfaction using Malaysia Airlines.**

<b>CORRELATIONS</b>			
		<b>Involvement</b>	<b>Tourist Satisfaction</b>
<b>Involvement</b>	Pearson Correlation	1	.749
	Sig. (2-tailed)		.000
	N	384	384
<b>Tourist Satisfaction</b>	Pearson Correlation	.749	1
	Sig. (2-tailed)	.000	
	N	384	384

\*\*Correlation is significant at the 0.01 level (2-tailed)

**Table 6: Correlation Analysis for Hypothesis 3**

Table 6 shows a correlation value of 0.749, demonstrating a positive association between Malaysia Airlines workforce and customer satisfaction. This demonstrates that the link between people and customer happiness is very strong and firmly associated among Malaysia Airlines customers who choose Malaysia Airlines as their preferred airline to travel to their destination. Personnel has a significant value of 0.000, which is less than the 0.01 significance criterion. As a consequence, when travelling with Malaysia Airlines, there is a high correlation between crew and customer happiness. As a result, H3 is suitable.

## **DISCUSSION AND RECOMMENDATION**

As identified in the opening chapter of this research, discussions are aimed at answering concerns and addressing issues. In general, this study thoroughly investigated the influence of the service quality air qual model on Malaysia Airlines customer satisfaction. Based on the study's findings, there are some recommendations for improving consumer satisfaction as well as the researchers in future studies.

This research has significance for the continuation of future research. Future researchers should examine and select a specific research subject to make it simpler for respondents to grasp that issue by adding additional demographic information about the respondents. Age, gender, education level, occupation, marital status, and many more factors can all be used to create distinct conclusions or findings from diverse perspectives. The researchers can obtain more detailed and precise data by doing this investigation.

Furthermore, future researchers could enhance data gathering for This research, particularly in terms of respondent allocation. Instead of handing out questions in person, future researchers can use Google Forms to distribute questionnaires. Some respondents, for example, refused to respond and ignored the researchers' questionnaire. As a consequence, while providing questionnaires to possible respondents, researchers may rapidly contact the respondent via Whatsapp status, groups, or personally and explain the research goal in-depth and precisely.

## **CONCLUSION**

Finally, the goal of this study was to identify the factors that influence tourist satisfaction while utilising Malaysia Airlines as their favourite domestic carrier. Three independent factors were chosen to explore the link between the dependent variable, customer satisfaction, and Malaysia Airlines as a preferred domestic carrier: service quality, airlines tangible, terminal tangible, and staff. 384 participants aged 18 and above were chosen at random to complete the questionnaire. The assumptions are confirmed in our study by examining data from 384 respondents using the SPSS programme. Every theory was confirmed to be right.

## REFERENCE

Al-Ababneh, M. M. (2013). *Service Quality and its Impact on Tourist Satisfaction*.

[https://papers.ssrn.com/sol3/papers.cfm?abstract\\_id=3633075](https://papers.ssrn.com/sol3/papers.cfm?abstract_id=3633075)

*An assessment of service quality and resulting customer satisfaction in Pakistan*

*International Airlines: Findings from foreigners and overseas Pakistani*

*customers* | *Emerald Insight*. (2015, May 5).

[https://www.emerald.com/insight/content/doi/10.1108/IJQRM-07-2013-](https://www.emerald.com/insight/content/doi/10.1108/IJQRM-07-2013-0110/full/html)

[0110/full/html](https://www.emerald.com/insight/content/doi/10.1108/IJQRM-07-2013-0110/full/html)

*An investigation on the factors influencing passengers' loyalty in the North Cyprus*

*national airline* | *Emerald Insight*. (2008, April 25).

[https://www.emerald.com/insight/content/doi/10.1108/17542730810867272/](https://www.emerald.com/insight/content/doi/10.1108/17542730810867272/full/HTML?fullSc=1)

[full/HTML?fullSc=1](https://www.emerald.com/insight/content/doi/10.1108/17542730810867272/full/HTML?fullSc=1)

*Frequent flyers benefits.* (n.d.).

[https://www.malaysiaairlines.com/uk/en/experience/oneworld/frequent-flyer-ben-](https://www.malaysiaairlines.com/uk/en/experience/oneworld/frequent-flyer-benefits.html)

[efits.html](https://www.malaysiaairlines.com/uk/en/experience/oneworld/frequent-flyer-benefits.html)

*Introduction to SPSS for statistical analysis* | *Research Commons*. (n.d.).

[https://researchcommons.library.ubc.ca/introduction-to-spss-for-statistical-](https://researchcommons.library.ubc.ca/introduction-to-spss-for-statistical-analysis/)

[analysis/](https://researchcommons.library.ubc.ca/introduction-to-spss-for-statistical-analysis/)

*Measuring Airline Service Quality Using AIRQUAL Model: A Study Applied to Egyptair*.

(n.d.). <https://www.readcube.com/articles/10.21608/ijhth.2018.31517>

**A Study on Tourist Satisfaction Towards Ferry Services in Langkawi**  
*Nuraini Binti Hussin, Nuralisha Nadia Binti Mohd Khari, Nuratika Binti Mawallil,*  
*Nureen Shahirah Binti Mohamad & Nurul Aziah Binti Ahmad\**

*Faculty of Hospitality, Tourism and Wellness, Universiti Malaysia  
Kelantan Corresponding email: [nurulaziah@umk.edu.my](mailto:nurulaziah@umk.edu.my)*

---

## **ABSTRACT**

*The objective of this research proposal is to examine tourist satisfaction with ferry services in Langkawi. Additionally, this study aims to examine relationships between quality service, high fares, and ferry safety assessment on tourist satisfaction toward ferry services in Langkawi. 384 questionnaires were distributed to the community. This study used a quantitative approach. The sample size was collected using convenient sampling. Data was collected through an online survey. This study shows that the three factors of service quality, high fares, and ferry safety assessment are the main factor that influences tourist satisfaction.*

**Keywords: Tourist Satisfaction, Quality Service, High Fares, Ferry Safety Assessment**

---

## **INTRODUCTION**

Tourism is travel for pleasure or business; it is also the theory and practice of touring, the business of attracting, accommodating, and entertaining tourists, and the business of operating tours. The tourism sector in Malaysia also contributed to the most important element that guarantees future business growth: tourist satisfaction. Today, many businesses use traveler happiness as a key metric to measure the effectiveness of their operations. By establishing the right process that ensures the services provided meet tourist expectations, tourist satisfaction is achieved. According to the tourism literature, a study shows that tourist satisfaction with a service or place is an important factor. This is because if tourists are happy with their trip to a location, they may recommend it to others.

## **SIGNIFICANCE OF THE STUDY**

The study aims to assess tourist satisfaction with ferry services in Langkawi. The findings are expected to be significant for improving satisfaction levels among tourists. The study can also serve as a reference for future research on ferry services in Langkawi. The expansion of the tourist sector in Langkawi relies on addressing the issues faced by visitors. The study's practical implications are valuable to a wide range of individuals, including visitors, tour guides, and business people. The research question "To what extent are tourists satisfied with the ferry service in Langkawi?" will be explored using a questionnaire as the primary tool for evaluation. This study focuses solely on the questionnaire as the means of gathering data, and any other approaches are beyond the scope of the research and may be considered study limitations. In summary, the study anticipates significant findings regarding tourist satisfaction with ferry services in Langkawi. It can guide future studies and be useful for visitors, tour guides, and business people. The research will employ a questionnaire as the primary tool for data collection, specifically exploring the research question mentioned.

## **LITERATURE REVIEW**

### **Tourist Satisfaction**

Tourist satisfaction plays an important role in ensuring the long-term viability of tourist attractions. Tourist satisfaction is recognized as an important indicator of long-term tourism sustainability. (Gidey & Sharma, 2017). It has the potential to aid in the development of sustainable tourism. (Daud & Rahman, 2011; Razovic, 2013). Tourist satisfaction can determine a tourism company's long-term success. (Gursoy et al., 2007; Razovic, 2013). Tourist satisfaction is an important factor in determining long-term tourism development in a given heritage site. It reflects the quality of tourism management in terms of services and visitor motivation. Tourist satisfaction, according to Beard and Ragheb, is the level of affirmative emotion and awareness formed after participating in certain leisure activities. It was defined by Lounsbury and Polik as the tourist evaluation following the overall tourism experience. Satisfaction is defined as the customer's overall evaluation of the service received in comparison to the service expected. This definition captures the cognitive aspect of satisfaction; however, it is important to note that satisfaction also has an emotional component. In the research of (Miguel Jesus Medina-Viruel, 2019)

### **Quality Service**

The tourist's assessment of the standard of service delivery performance associated with the travel experience is defined as service quality. (Chen & Tsai, 2007). Recent service quality definitions have expanded to include a visitor's emotional response. Service quality might thus be determined by the visitor's overall assessment of a location based on their experiences and internal sentiments. (Cong, 2016). A general definition of service quality is a visitor's evaluation of the amenities and services offered at a location based on their personal feelings and experience. SERVQUAL, a service quality model developed by Parasuraman et al. (1988), recognized the tangible aspects of services. SERVQUAL is divided into five categories: tangibles, empathy, dependability, responsiveness, and assurance. Service quality can be defined as a company's ability to meet or exceed customer expectations. It is the difference between the customer's expected and perceived level of service. Good service quality will increase a company's profitability by increasing its customer base.

### **High Fares**

Choosing a daily price is equivalent to choosing a travel expense. The market value of a holiday is determined by its price. Therefore, price coordination through destination management and coordination provided by tourism operators that supply vacations include management decisions that balance supply and demand to control prices or inventory availability to maximize revenue growth and profits (Ugurlu, Cosgun, and Ekinici, 2012). Maximizing profit from ticket sales may increase funding but can meet customers' social needs for a trip. As reported by a local newspaper article (Bernama, 2018). From an economic perspective, ferries promote economic development by increasing land values, motivating sector tourism, and attracting excess spending (Mittleman, 2018). The main feature of the price optimization issue for vehicles (ferries).

### **Ship Safety**

The rehabilitation of the tourism sector has been somewhat slowed down by a string of events involving stranded passenger ferries in the waters off Kuala Kedah and Kuala Perlis. Imagine that on the 23<sup>rd</sup> and 28<sup>th</sup> of October last year, two occurrences occurred within five days as a result of the ferry becoming trapped on a sandbar and the buoy cable becoming

entangled in the mouth of Kuala Kedah (Kosmo, 2022). Many tourists are also forced to reconsider visiting Langkawi Island due to the ferry journeys, which have been cut in half compared to the norm of 10 excursions in 2019. In addition, safety on the ferry is also the talk of tourists. This is because they do not care about the safety of passengers. For example, not requiring tourists to wear life jackets. Also, luggage storage is very disorganized. If there is an accident, it will prevent the movement of passengers to get to the emergency door.

### Research Hypothesis

The study's hypothesis is to determine whether the dependent variable and independent variable have any relationship or correlation.

**H1:** There is a significant relationship between service quality and tourist satisfaction using the ferry in Langkawi

**H2:** There is a significant relationship between high fares and tourist satisfaction using the ferry in Langkawi.

**H3:** There is a significant relationship between ferry safety and tourist satisfaction using a ferry in Langkawi.

### Research Framework

As a result, research on visitor satisfaction demonstrates a significant correlation between high prices and quality service, as well as an evaluation of ship safety. Consequently, the model can be altered as follows:

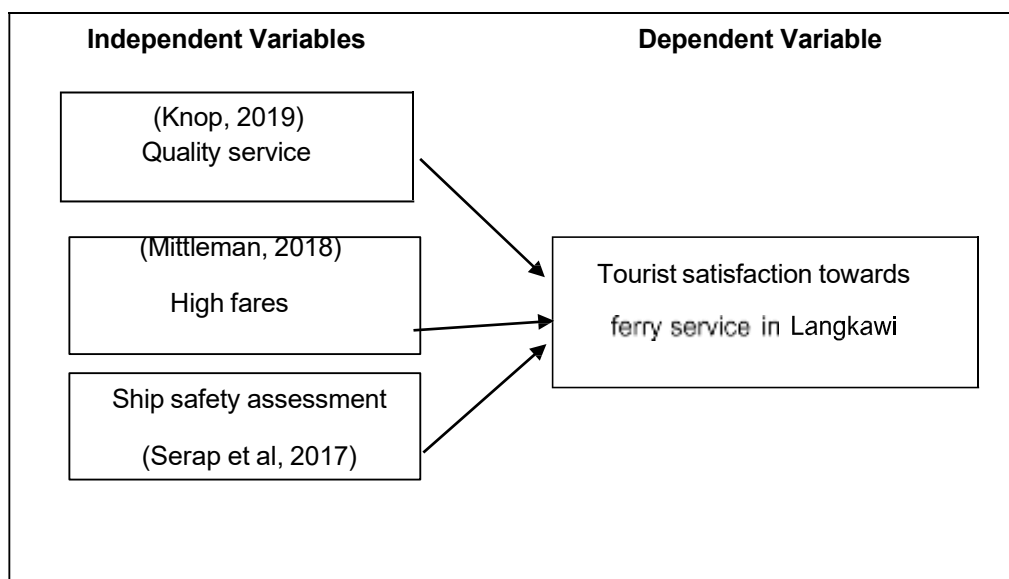

## **METHODOLOGY**

### **Research Design**

The purpose of this study is to investigate how users' perceptions related to quality services, high fares, and ship safety ratings in ferry services. The researcher used a cross-sectional research design, which involved collecting data from multiple individuals at one time. A quantitative approach was employed, and a survey using a questionnaire was used as the research method. The sample consisted of tourists aged 18 to 45 who had traveled and used ferry services in Langkawi. The questionnaire included predefined options for demographic information. To measure tourist satisfaction, a Likert scale was used, ranging from 1 (strongly disagree) to 5 (strongly agree). Data collected through the questionnaire will be analyzed using the Statistical Package for the Social Sciences (SPSS), a statistical analysis tool. After the analysis, the study's conclusions will be shared with the respondents, providing them with information about the research findings.

### **Data Collection**

Data collecting is a technique for compiling information from numerous sources to provide thorough and trustworthy data. Data gathering enables people or organizations to assess outcomes, provide meaningful answers to queries, and predict potential future possibilities and trends. Data for this inquiry were gathered by a survey that employed a questionnaire. A questionnaire is a tool for gathering data that involves asking respondents several questions. Additionally, because it is standardized, this kind of research is typically less expensive and simpler to manage than other approaches. Furthermore, because there is a large number of participants in this study, the researcher used this strategy because it is an effective method to collect data and information. The study used primary data to obtain data for this investigation. Primary data is information that researchers obtain directly from primary sources through experiments, surveys, and interviews. The largest type of data for research is primary data, which is usually collected from the same place where the statistics were first discovered. In addition, in this study, a descriptive quantitative research design was used. The target population, visitors who use the Langkawi ferry service, was collected using a sampling method.

### **Sampling**

Non-probability convenience sampling will be used in this investigation as the sampling method. Convenience sampling methodology enables researchers to choose any accessible respondent of their choice, as opposed to choosing from the entire population. Convenience sampling is employed in this study to cut costs and save time during the data collection phase. Visitors who had been to Langkawi and traveled there by ferry were the ones that responded to the questionnaire. It is possible to complete a questionnaire and generate statistics based on the responses as the number of tourists visiting Langkawi rises.

### **Data Analysis**

Frequency analysis, descriptive analysis, and reliability analysis are the three types of data analyses that were used in this study. The collected data were analyzed with the Statistical Package for the Social Sciences (SPSS) to demonstrate the relationships between the dependent and independent variables as a set of statistical processes approximated by regression analysis.

## FINDINGS

Demographic	Categories	Frequency (N)	Percentage (%)
<b>Gender</b>	Male	75	19.5
	Female	309	80.5
<b>Age</b>	Below 20	49	12.8
	21 – 29	292	76.0
	30 – 39	0	0.0
	40 – 49	41	10.7
	50 – 59	2	0.5
<b>Race</b>	Malay	349	90.9
	Chinese	18	4.7
	Indian	5	1.3
	Others	12	3.1
<b>Marital</b>	Single	300	78.2
	Married	80	20.8
	Others	4	1.0

**Table 1: Respondent Profile**

Table 1 shows 384 profiles of the respondents and most of them are female which is 80.5% of the total of the gender total while male only 19.5%. The majority of the respondents are at the age of 21 – 29 years old which is 76% more than others. Meanwhile, for race, the highest number of respondents are Malay with 90.9% while Indian has the lowest frequency with 1.3%. For marital status, most of the respondents are single 78.2%, followed by married status with 20.8% and only 1% others. Thus, the data accurately reflect the real demographic compilation on the tourist satisfaction towards ferry service in Langkawi.



<b>Variable</b>	<b>Items</b>	<b>N</b>	<b>Mean</b>	<b>Standard Deviation</b>
<b>Tourist Satisfaction</b>	Tourists will recommend the Langkawi ferry service to other tourists who want to go there.	384	3.99	0.654
	Tourists are overall satisfied with the ferry service provided in Langkawi.	384	3.97	0.625
	Tourists will use the ferry service again after this.	384	4.01	0.658
	Tourists are satisfied with the service provided by the staff.	384	3.96	0.657
	Tourists feel comfortable while on the ferry.	384	3.97	0.654
<b>Service Quality</b>	The staff on the ferry provide obvious physical facilities and equipment to tourists while they are on board.	384	3.98	0.602
	In terms of service reliability, ferry workers deliver the promised service accurately and reliably.	384	4.00	0.594
	Ferry service staff consistently offer a good response, such as being ready to help tourists immediately.	384	4.04	0.586
	Ferry service staff in Langkawi can provide a good guarantee of tourist confidence and trust in them when using their services.	384	4.07	0.564
	Ferry staff are receptive and aware of the needs and concerns of their passengers.	384	4.05	0.594
	Using the ferry service to Langkawi is safe.	384	4.07	0.616
	The ferry used has complete safety features.	384	4.10	0.580

<b>Ship Safety Assessment</b>	The crew gives a safety briefing.	384	4.05	0.666
	The crew staff sufficient for enforcement purposes.	384	4.08	0.611

	The ferry specifications are suitable for use as public transportation.	384	4.08	0.573
<b>High Fares</b>	The price of ferry transportation in Langkawi is too high.	384	3.85	0.797
	The government and authorities need to take steps to control the cost of ferries in Langkawi.	384	4.07	0.632
	The convenience and comfort when riding the ferry in Langkawi are worth the high fare.	384	3.86	0.739
	The high fare can guarantee the safety of the passengers.	384	3.64	0.828
	Most of the ferries used in Langkawi have a high cost, causing customers to pay a high fare.	384	3.82	0.707

**Table 2: Descriptive Analysis of Tourist Satisfaction Towards Ferry Services in Langkawi**

Table 2 demonstrates the mean and standard deviation of the study's dependent and independent variables. The highest mean value in the dependent variable which is tourist satisfaction was obtained by Question 3 with 4.01 (SD=0.658) where the respondent agreed to use the ferry service again after this. The Independent variable for service quality had the highest mean value that belongs to Question 4 with 4.07 (SD=0.564) which means that the respondent agreed that service staff in Ferry Langkawi can provide a good guarantee of tourist confidence and trust in them when using their services. From the service quality in the questionnaire, Question 1 has the lowest mean value with 3.98 (SD=0.602) which means, the respondent agreed that the staff on the ferry provide obvious physical facilities and equipment to tourists while they are on board. After that, Question 2 from the ship safety assessment questionnaire has the highest mean value with 4.10 (SD=0.580), followed by Question 4 and Question 1 while Question 3 has the lowest mean value with 4.05(SD=0.666). It means the respondent agreed that the crew gives a safety briefing. For the last independent variable, Question 2 has the highest mean value with 4.07 (SD=0.632) meaning that respondents agreed with the statement that the government and authorities need to take steps to control the cost of ferries in Langkawi. While Question 4

followed by Question 5 is the lowest mean in the high fares question. This means that respondents agreed with the statement which is that high fares can guarantee the safety of the passengers and most of the ferries used in Langkawi have a high cost, causing customers to pay a high fare.

Variable	Number of Items	Reliability Cronbach's Alpha
Tourist Satisfaction	5	0.925
Quality Service	5	0.923
Ship Safety Assessment	5	0.922
High Fares	5	0.800

**Table 3: Reliability Analysis between Service Quality, Ship Safety Assessment, and High Fares toward Ferry Service in Langkawi.**

The findings of the reliability analysis for each variable are presented in Table 3. All variables have Cronbach's Alpha coefficient values of 0.800 and above. Tourist satisfaction has the highest Cronbach's Alpha coefficient of 0.925. The service quality Cronbach's Alpha coefficient value is 0.923. While the ship's safety assessment shows the value of Cronbach's Alpha coefficient is 0.922. The last independent variable, which is high fares, showed a Cronbach's Alpha result of 0.800. Therefore, all the questionnaire is acceptable and can be used in the study.

		Tourist Satisfaction Towards Ferry Service in Langkawi
Service Quality	Pearson Correlation	0.561
	Sig. (2-tailed)	<.001
	N	384
Ship Safety Assessment	Pearson Correlation	0.500
	Sig. (2-tailed)	<.001
	N	384
High Fares	Pearson Correlation	0.550
	Sig. (2-tailed)	<.001
	N	384

**Table 4: Pearson's Correlation Analysis between Service Quality, Ship Safety assessment, and High Fares toward Ferry Service in Langkawi.**

## **Relationship between Service Quality, Ship Safety Assessment, and High Fares toward Ferry Service in Langkawi.**

H1: There is a significant relationship between service quality and tourist satisfaction with ferry service in Langkawi.

The results in Table 4 show that the correlation between service quality and tourist satisfaction with ferry services in Langkawi is 0.561 which is considered a moderate positive correlation. In addition, service quality has shown a significant positive relationship with tourists' satisfaction with ferry services in Langkawi considering that the p-value is less than 0.05. In conclusion, hypothesis H1 is supported.

H2: There is a significant relationship between ship safety assessment and tourist satisfaction with ferry service in Langkawi.

The assessment of ship safety and tourist satisfaction with ferry services in Langkawi with 0.500 also shows a moderate positive correlation. Furthermore, the evaluation of ship safety has shown a significant positive relationship with tourists' satisfaction with ferry services in Langkawi considering that the p-value is less than 0.05. In conclusion, hypothesis H2 is supported.

H3: There is a significant relationship between high fares and tourist satisfaction with the ferry service in Langkawi.

High fares and tourist satisfaction with ferry services in Langkawi show 0.550, which shows a moderate positive correlation. Furthermore, high fares show a positive significant relationship with tourist satisfaction with ferry services in Langkawi considering that the p-value is less than 0.05. In conclusion, hypothesis H3 is supported

## **DISCUSSION AND RECOMMENDATION**

The discussion tries to provide answers to the issues and theories raised in the study's first chapter. The aspects that affect tourists' satisfaction with ferry services as their chosen mode of transportation for trips to Langkawi have generally been thoroughly investigated in this study. To increase learning in the future, there are some recommendations for tourism businesses and upcoming scholars based on the study's findings.

This study is important for the continuation of research in the future. It is recommended that future researchers investigate and provide more information related to ferry services. For example, a study on information about the benefits of ferry services to residents and visiting tourists and identifying tourists' satisfaction with ferry services. Next, choose a specific research topic to make it easier for the respondents to understand the topic by including more demographic information about the respondents. For example, age, race, gender, education level, occupation, marital status, and other factors, for instance, can provide various conclusions or findings from different perspectives. By doing so, the researcher can obtain more detailed and accurate data.

Future researchers could also refine how the data were gathered for this study, particularly concerning how the questionnaires were distributed. Instead of distributing questionnaires face-to-face, future researchers can conduct a Google Form questionnaire distribution. For example, some respondents do not want to answer and ignore the questionnaire presented by the researcher. As a result, when distributing questionnaires to potential respondents, researchers can get respondents quickly through contact via Twitter, Facebook, WhatsApp, and Instagram, whether for group or personal purposes and in detail and precisely.

## CONCLUSION

In conclusion, this research has been done to identify the elements that determine tourist satisfaction with the ferry service in Langkawi. Three independent variables which are service quality, high fares, and tourist satisfaction have been chosen to determine the relationship between the dependent variable, which is the number of tourists who prefer the ferry as a mode of transportation in Langkawi. A total of 384 respondents from the age 21-29 years old were selected randomly to answer the questionnaire. Based on our survey it was found that the hypotheses are supported by using the SPSS software to analyse the data using 384 respondents. It was found that all the hypotheses are supported. Moreover, all the independent variables have a strong relationship with the dependent variables.

## REFERENCES

- Akter, M., Sadekin, M. N., & Patwary, A. K. (2020). An Empirical Study on Students' Satisfaction from Mawlana Bhashani Science & Technology University, Bangladesh. *Review of Economics and Development Studies*, 6(2), 363-379.
- Alom, S., Patwary, A. K., & Khan, M. M. H. (2019). Factors affecting the turnover intention of Bangladeshi migrants in the United Arab Emirates: An empirical study on the hotel industry. *International Journal of Innovation, Creativity and Change*, 8(3), 344-360.
- Anvari, F., & Lakens, D. (2021). Using anchor-based methods to determine the smallest effectsize of interest. *Journal of Experimental Social Psychology*, 96, 104159. <https://doi.org/10.1016/j.jesp.2021.104159>
- Atsbha Gebreegziabher Asmelash & Satinder Kumar (2019). The structural relationship between tourist satisfaction and sustainable heritage tourism development in Tigray, Ethiopia <https://www.sciencedirect.com/science/article/pii/S2405844018368336>
- Chapman, S. J. (2017). Review of Discovering Statistics Using IBM SPSS Statistics, 4th Edition. *Journal of Political Science Education*, 14(1), 145–147. <https://doi.org/10.1080/15512169.2017.1366328>
- Dr. Abdullah Promise Opute & Dr. Bridget Obiageli Irene(2020).Tourism Service and Digital Technologies: A Value Creation Perspective [https://www.ajhtl.com/uploads/7/1/6/3/7163688/article\\_5\\_vol\\_9\\_2\\_2020\\_germany.pdf](https://www.ajhtl.com/uploads/7/1/6/3/7163688/article_5_vol_9_2_2020_germany.pdf)
- Dr. E. Iniyan (2015).Tourism in Tamilnadu: Role of Cultural/Heritage Sites in TouristSatisfaction and Tourism Development.(40 - 46)
- Fengmin, Z., Baijun, W., Jiangtao, B., Li, L., & Patwary, A. K. (2022). Investigating revisit intention of medical tourists in China through nutritional knowledge, perceived medical quality, and trust in the physiologist: A recommendation on health tourism policy measures. *Frontiers in Public Health*, 10, 893497.
- Hazbar, A. M. H., alem Mohammed, A., & Karim, A. K. A. (2019). An Empirical Study of Factors Influencing hotel customers' online booking Intention. *مجلة العلوم التربوية و الدراسات الإنسانية*, (5), 1-17. [https://www.ijhsss.com/old/files/E\\_m8u9067e.-Iniyan.pdf](https://www.ijhsss.com/old/files/E_m8u9067e.-Iniyan.pdf)
- Li, L., Ragavan, N. A., Patwary, A. K., & Baijun, W. (2022). Measuring patients' satisfaction toward health tourism in Malaysia through hospital environment, nutritional advice, and perceived value: A study on Chinese exchange students. *Frontiers in public health*, 10, 893439.

- Li, L., Wu, B., & Patwary, A. K. (2022). How marine tourism promote financial development in sustainable economy: new evidences from South Asia and implications to future tourism students. *Environmental Science and Pollution Research*, 29, 1155-1172.
- Li, L., Wu, B., & Patwary, A. K. (2022). The psychosocial factors affecting chinese Outbound Exchange and mobility students' academic performance during COVID-19. *Frontiers in psychology*, 13, 872516.
- Madrid (2017). World Tourism Organization : UNWTO Anuual Report 2016, <https://doi.org/10.18111/9789284418725>
- Mahadirah Mohamad, Muhamad Nasyat Muhamad Nasir, Nur Izzati Ab Ghani & Asyraf Afthanorhan (2019). Parallel Mediators of Place Attachment and Tourist Satisfaction in Destination Attractiveness, Destination Loyalty and Service Quality [https://www.ijicc.net/images/vol7iss7/7717\\_Mohamad\\_2019\\_E\\_R.pdf](https://www.ijicc.net/images/vol7iss7/7717_Mohamad_2019_E_R.pdf)
- Manjula Chaudhary & Abhishek Aggarwal (2012). Tourist Satisfaction and Management of Heritage Sites in Amritsar <https://www.sajth.com/old/july2012/Microsoft%20Word%20%20005+Manjula+Chaudhary.pdf>
- Muhammad Nadzmi Muhammad Idran & Dr Harlina Suzana Jaafar (2021). Developed SERVQUAL Model in Measuring Customer Satisfaction for Ferry Service In Langkawi. <http://ieomsociety.org/proceedings/2021indonesia/416.pdf>
- Patwary, A. K., Roy, B., Hoque, R., & Khandakar, M. S. A. (2019). Process of developing a community based tourism and identifying its economic and social impacts: An Empirical study on Cox's Bazar, Bangladesh. *Pakistan Journal of Humanities and Social Sciences*, 7(1), 1-13.
- Simone Abram, Jacqueline Waldren & Donald V.L. Macleod (2020). Tourists and Tourism Yeamduan Narangajavana kaosiri, Luis Jose Callarisa Fiol & Javier Sanchez Garcia (2017).
- Sumethokula, P., Patwary, A. K., Srinuanpanc, B., Srinuanpand, C., Suwandee, P., Thammathikulf, A., & Phanong, W. (2020). The potential of new tour repackaging for creative tourism among entrepreneurs in Nakhon Si Thammarat. *International Journal of Innovation, Creativity and Change*, 13(10), 1752-1771.
- Wu, B., Liu, S., Wang, J., Tahir, S., & Patwary, A. K. (2021). Assessing the mechanism of energy efficiency and energy poverty alleviation based on environmental regulation policy measures. *Environmental Science and Pollution Research*, 28, 40858-40870.
- Wu, B., Zhai, B., Mu, H., Peng, X., Wang, C., & Patwary, A. K. (2021). Evaluating an economic application of renewable generated hydrogen: A way forward for green economic performance and policy measures. *Environmental Science and Pollution Research*, 1-15.

# **Examining Customer Satisfaction Toward Quality Service at Zamburger Hotel: A Quantitative Study**

*Nurfaizatul Fatieha binti Mohd Syukri, Nurfarisha Alia binti Bakri, Nurfitriah Akma Laila binti Azmi, NurHanis Alia binti Isram & Nurul Aziah Binti Ahmad\**

*Faculty of Hospitality, Tourism and Wellness, Universiti Malaysia Kelantan*

*Corresponding email: [nurulaziah@umk.edu.my](mailto:nurulaziah@umk.edu.my)*

---

## **ABSTRACT**

*This study aims to establish a connection between consumer satisfaction and exceptional service at the Zamburger Hotel in Pengkalan Chep, Kelantan. Customer satisfaction is defined as a metric that evaluates the extent to which consumers are satisfied with a company's products, services, and capabilities. Customer satisfaction information, such as surveys and evaluations, can help a business determine how to enhance or modify its products and services. Providing quality customer service entails providing consumers with prompt, polite, and expedient assistance while also establishing strong relationships with them. Customers lodging at Hotel Zamburger are the scope and limits of this investigation. This study's sample comprises of Kelantan's general population and foreign visitors. They will comment on the calibre of service at the Zamburger Hotel. Using questionnaires as the research instrument, the researchers employ quantitative and descriptive methods in this study.*

**Keywords: Customer satisfaction, Service Quality**

---

## **INTRODUCTION**

Many different forms of study have been conducted on the issue of inadequate customer satisfaction in service quality levels at Hotel Zamburger. This study was chosen because many problems emerge from employees and some from employers. Hiring the wrong people for critical jobs is one of the reasons for poor and insufficient service. Work, a lack of training, staff fatigue, a misinterpretation of client expectations, and a lack of employee involvement are all factors. Furthermore, research has revealed that another issue with Zamburger Hotel is limited



facilities and less clean accommodation. This issue develops due to a lack of cleaning employees at the hotel as well as clients who do not care about cleanliness while staying at this Zamburger Hotel.

This study focuses on client satisfaction with high-quality services. It is a vital step in developing customer loyalty, pleasing consumers, and producing great word-of-mouth. The research on this subject has chosen references to gain further material, such as literature, newspapers, journals, and so on. Furthermore, the nomenclature employed is specific. The focus of the study was confined to the relationship between customer contentment and service quality. The sample size is the number of people or observations that comprise the sample. The sample size for the study is determined by the cost of data collection and the statistical power (Singh & Masuku, 2014). Customers of the Zamburger Hotel comprise the study's sample. The researchers will employ 384 respondents in their sample for this study. The researcher will choose the size of the sample utilized in this study to collect replies. As a result, all races and faiths who opted to reply to the questionnaire are included in our sample size.

Therefore, the primary objective of this research is to examine the relationship between customer satisfaction toward quality service at the Zamburger Hotel. There are three research objectives:

1. To examine the relationship between service quality (reliability, assurance, tangible, empathy, responsiveness) of Zamburger Hotel towards customer satisfaction.
2. To examine the relationship between the high prices of the Zamburger Hotel towards customer satisfaction.
3. To examine the relationship between responsiveness and customer satisfaction in Zamburger Hotel.

## **SIGNIFICANCE OF THE STUDY**

The outcomes of this study are expected to have a major impact on quality service. Furthermore, this research will assist consumers in determining the impact of customer satisfaction on the quality of service, which is bad and inadequate, as well as inadequate amenities and less hygienic housing.

## **LITERATURE REVIEW**

### **Service Quality**

Quality is a theory that is evasive and ambiguous, and it is also important to differentiate between commodities and services as they have distinct characteristics, according to (Ali et al., 2021) in the research of (Abdullah & Afshar, 2019). The former is more tangible than the latter, which is an immaterial live performance (Abdullah & Rahman, 2015). Many definitions and ideas of service quality are presented in academic literature and a substantial body of research, and many of these works also compare consumer expectations with performance. According to Parasuraman, Valarie, Zeithaml, and Berry's research (Ali et al., 2021), service quality is "the perception coming from the contrast of customer expectations with actual service performance" (paraphrased from Parasuraman, Valarie, Zeithaml, and Berry, 1985, p. 42). According to Churchill and Surprenant (1982) and Parasuraman et al. (1985), who together popularised the theory of customer satisfaction through the measurement of a firm's actual service delivery following customer expectations as defined by the achievement of perceived quality, service was defined in the 1980s as meeting the wants and needs of the customer above and beyond their expectations. According to Fida et al. (2020), this method employs five quality factors to define the excellence of a service. This dimension consists of five components: tangibility, dependability, responsiveness, assurance, and empathy; however, various authors have altered the meanings of these components. It evaluates consumers' perceptions of service quality based on the gap between their expectations and their actual experiences. Because service quality is a multifaceted concept, each SERVQUAL dimension provides unique characteristics for evaluating customer perceptions and expectations of service quality in the hospitality industry. (Al Ababneh, 2017).

### **Customer Satisfaction**

According to (Suchánek & Králová, 2019), it is also crucial to evaluate customer satisfaction in the context of competitiveness because, as Hennig-Thurau & Klee (1997) claimed, customer satisfaction has a significant impact on the competitiveness of the product and, by extension, on the firm. In the business world, "customer satisfaction with a company and its products is generally considered the key to a company's performance and long-term competitiveness." Focusing on satisfying customers is crucial to a company's long-term success, as shown by the definition of "customer satisfaction" provided by Zeithaml et al. (1996). To put it another way, in order to achieve customer happiness, a firm must provide results that go above what customers anticipate. Several researchers (Fida et al., 2020) Customers are more likely to remain loyal if their needs are consistently met, which in turn decreases the likelihood of customer churn, as stated by Lau and Cheung (2013). Customer satisfaction and the subsequent connection between the business and the client stem in large part from the quality of the service provided (Amin & Isa, 2008).

## **Customer Expectations**

According to the study of Hallowell (1996), as referenced by Uzunboylu (2016), knowing the expectations or wants of consumers enables companies to determine how to best serve the customer and offers a basis for making changes to increase their satisfaction. The term 'expectation' varies depending on how it is used in the literature on service quality or customer satisfaction (Parasuraman et al., 1988). In the literature on service excellence, "expectations" refer to the wishes or desires of consumers. In other words, people's opinions about what the service should be as opposed to what it is. In the satisfaction literature, on the other hand, it is employed as a customer's forecast of what is likely to happen during a service exchange (Kunst & Lemmink, 1996). According to Parasuraman et al. (1988), the term "expectations" can have various meanings depending on where you look in the service quality or consumer satisfaction literature. Kunst and Lemmink (1996) define expectations as the customer's intentions or desires in the service quality literature. In other words, individuals are more concerned with what the service should be than with what it actually is. In the satisfaction literature, however, it refers to a customer's anticipation of what might occur during a service exchange, as cited by Uzunboynu (2016).

## **Research Hypothesis**

The study's hypothesis is to determine whether there are correlations or relationships between dependent variables and independent variables.

**H1:** There is a positive relationship between service quality and customer satisfaction at Zamburger Hotel.

**H2:** There is a positive relationship between high prices and customer satisfaction at Zamburger Hotel.

**H3:** There is a positive relationship between responsiveness and customer satisfaction at Zamburger Hotel.

## Research Framework

The research framework utilised for this investigation is illustrated in Figure 1.

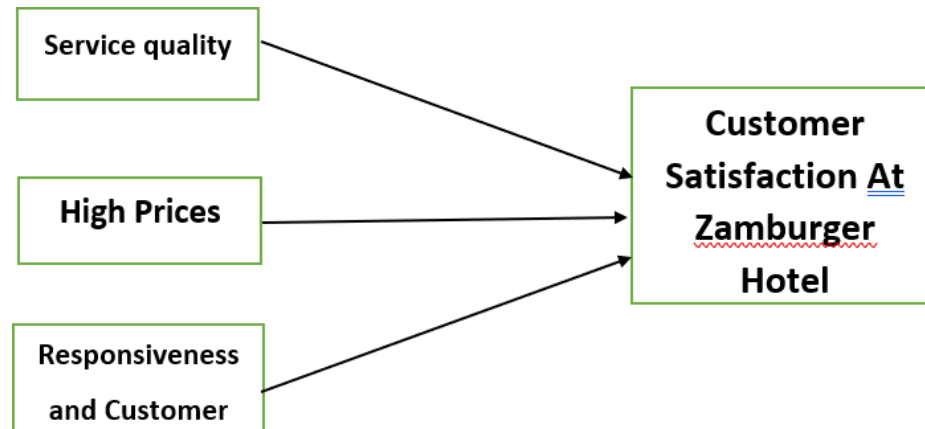

Figure 1: Research Framework

## METHODOLOGY

### Research Design

This research method applied the quantitative approach and used a survey that was conducted through questionnaires. This research consists of the general public and foreign tourists in Kelantan. The Likert scale has been applied to know the level of satisfaction of customers towards quality service at Zamburger Hotel which is service quality, high prices, responsiveness, and customer loyalty.

### Data Collection

This study uses primary data as its method of data collection. Through experiments, surveys, and interviews, it was obtained directly from primary sources. The general public and foreign visitors are the focus of this quantitative, descriptive study. In addition, data are gathered using a probability-stratified sampling method. This study uses a Google Form to create questionnaires and distributes them via social media platforms such as Twitter, Facebook, WhatsApp, and Instagram to collect data. The surveys consisted of four sections: Section A for demographic information, Section B for

suggestions on customer service quality, Section C for customer satisfaction with costly products, and Section D for consumer expectations regarding responsiveness and loyalty.

**Sampling**

Sampling is picking a group from which the researchers will gather the data for their study. The probability and non-probability sampling methods are the two available sampling techniques. A probability sampling technique has been applied in this study. Using probability sampling, which incorporates random selection, will able the researcher to draw robust statistical conclusions about the entire group.

**Data Analysis**

Regarding data analysis, the information gathered for this analysis will be analysed using Statistical Package for the Social Sciences, Version 27 (SPSS). This IBM SPSS version 27 is a comprehensive set of statistical instruments for processing statistical data and generating a variety of outputs in response to the research question.

**FINDINGS**

**Demographic Profile**

Table 4.1: Number of Respondents by Demographic Profile

<b>Gender</b>	<b>Frequency</b>	<b>Percent (%)</b>
Female	89	42.2
Male	122	57.8
<b>Age</b>	<b>Frequency</b>	<b>Percent (%)</b>
20 years and below	24	11.4
21 - 30 years old	121	57.3

31 - 40 years old	50	23.7
41 - 50 years old	11	5.2
51 - 60 years old and above	5	2.4
<b>Marital Status</b>	<b>Frequency</b>	<b>Percent ( % )</b>

Single	156	73.9
Married	48	22.7
Others	7	3.3
<b>Race</b>	<b>Frequency</b>	<b>Percent ( % )</b>
Malay	148	70.1
Indian	35	16.6
Chinese	24	11.4
Others	4	1.9
<b>Monthly Income</b>	<b>Frequency</b>	<b>Percent ( % )</b>

RM 1000 and below	135	64.0
RM 1000 - RM 20000	45	21.3
RM3000 and above	31	14.7

Table 4.1: Summary of Demographic Profile

The demographic characteristics of the respondents are depicted in table 4.1. 211 individuals have responded in total. The number and percentage of respondents are shown based on gender in Table 4.1 and figure out of 211 respondents, 122 respondents were male and the remaining 89 respondents were female. As can be seen here, the respondents were predominantly male compared to female. The percentage of male respondents was 57.8%, which was higher than the female respondent's 42.2%.

The number and percentage of respondents are shown based on age in Table 4.2.2 and figure out, 21-30 years old is the highest of respondents with 121 (11.4%). The second range of age is 31-40 years old that is 50 (23.7%). The third range of age is 20 years and below with 24 (11.4%). Next for the fourth range of age is 41-50 years old with 11 (5.2%) meanwhile 51-60 years old and above respondents 5 (2.4%).

The number and percentage of respondents are shown based on monthly Income in Table 4.2.5 and figure out, and for monthly income RM 1000 and below is the highest of respondents with 135 (64%). The second range of monthly Income for RM1000 - RM20000 is 45 (21.3%) meanwhile for RM3000 and above respondents is 31 (14.7%).

### Descriptive Analysis

Descriptive analysis is the practise of providing a concise summary of a data set that may stand in for the complete population or for a specific subset of that population.

#### 4.3.1 Service Quality

Variables	N	Mean	Standard Deviation
-----------	---	------	--------------------

You are satisfied with the service quality that Zamburger Hotel provided.	211	4.09	.719
You are satisfied with the appearance of the Zamburger Hotel	211	4.11	.701



You are satisfied with the cooperation that was given by the staff at Zamburger Hotel	211	4.15	.728
When they promise to do something by a certain time, they do it	211	4.09	.683
When a customer has a problem, they should show sincere interest in solving the problem	211	4.08	.658

Table 4.2: Descriptive statistics of service quality

### 4.3.2 High Prices

<b>Variables</b>	<b>N</b>	<b>Mean</b>	<b>Standard Deviation</b>
Do you think the price of an overnight stay is reasonable and affordable with the service, facilities, and accommodation provided by Zamburger Hotel?	211	4.10	.703
You are satisfied with the price and promotion on sales service by Zamburger Hotel.	211	4.06	.760
The frequency with which customers come to Zamburger Hotel has a positive effect on customer loyalty	211	4.10	.714
Price and value have a positive impact on customer loyalty	211	4.08	.746
Service quality has a positive impact on customer loyalty	211	4.04	.713

Table 4.3: Descriptive statistics of high prices

### 4.3.3 Responsiveness

Variables	N	Mean	Standard Deviation
You are very satisfied with our hotel and will recommend Zamburger Hotel to your friends or colleagues	211	4.13	.691
You will likely stay at Zamburger Hotel again.	211	4.18	.687
Overall, at what level were you satisfied with Zamburger Hotel?	211	4.07	.747

Table 4.4: Descriptive statistics of responsiveness

## RELIABILITY TESTS

Table 4.3 shows the pilot survey test result.

Construct	Cronbach's Alpha	No of Item	N
Service Quality	.895	5	30
High Prices	.822	5	30
Responsiveness	.913	3	30

## PEARSON'S CORRELATION

Hypothesis	Result	Findings of Data Analysis
<b>H1:</b> There is a positive relationship between service quality and customer satisfaction at Zamburger Hotel	r = 0.874,  p = >.001  Moderate positive	<b>H1: Accepted</b>
<b>H2:</b> There is a positive relationship between high prices and customer satisfaction at Zamburger Hotel	r = 0.837,  p = >.001  Moderate positive	<b>H2: Accepted</b>
<b>H3:</b> There is a positive relationship between responsiveness and customer satisfaction at Zamburger Hotel	r = 0.821,  p = >.001  Moderate positive	<b>H3: Accepted</b>

Table 4 serves to summarise the findings of this study.

Based on Table 4, the result revealed that all three variables have a strong relationship with customer satisfaction at Zamburger Hotel with a correlation value from  $0.874 > 0.837 > 0.821$ . The highest correlation relationship was service quality and the lowest one was responsiveness. Nevertheless, all hypotheses are accepted.



## DISCUSSION AND RECOMMENDATION

The purpose of the discussions was to address the questions and hypotheses raised in the first chapter of this study. In general, this study has investigated in depth Customer satisfaction with respect to quality service at the Zamburger Hotel. On the basis of the study's findings, there are a number of recommendations for future tourism operators and researchers.

The first recommendation is that the manager of Zamburger Hotel should promote regular customers. For example, regular customers can get a discount or special price. Promotions are vital since they are a wonderful method to immediately increase occupancy and income when you are facing a low time or want to capitalize on a high period. A good campaign will enhance client trust by providing them with awareness, value, and excitement.

Furthermore, the hotel manager should provide more facilities for customers such as fitness facilities. The majority of modern hotels have some kind of fitness center. This might be as basic as a room with a few key workout devices. Fitness facilities at a more notable upmarket hotel may comprise many rooms, including a full gym manned by trained trainers. While not everyone keeps up their exercise routine while on vacation, many guests like exercising and want to prevent being deconditioned while traveling. Good facility management is critical here since selecting appropriate equipment and ensuring safety are critical.

The final suggestion is that hotel personnel should continue to provide superior service to guests. Consistent labour and effort are required from the staff in order to provide exceptional customer service. Customers must be engaged, courteous, accessible, and, above all, attentive to the customers. Moreover, empathy is essential not only for resolving but also for comprehending problems. The staff must first comprehend the needs and perceptions of the visitors in order to devise an outstanding solution. Effective customer service can quickly adapt to any circumstance and has an in-depth understanding of its customers' needs.

## CONCLUSION

Ultimately, the purpose of this study is to examine customer satisfaction with respect to the quality of service at the Zamburger Hotel. There are three independent variables: service quality, price, and responsiveness. Each of these variables affects the dependent variable, which is the level of customer satisfaction at the Zamburger Hotel.

## REFERENCES

- A. Ananth, R. Ramesh, & Dr. B. Prabakaran. (2011). Service Quality Gap Analysis in Private Sector Banks – A Customers Perspective. Indian Journal of Commerce and Management Studies, 2(1), 245–253. <https://www.ijcms.in/index.php/ijcms/article/view/65>*
- Al Ababneh, M. M. (2017). Service Quality in the Hospitality Industry. Journal of Tourism & Hospitality, 06(01). <https://doi.org/10.4172/2167-0269.1000e133>*

Ali, B. J., Gardi, B., Othman, B. J., Ahmed, S. A., Ismael, N. B., Hamza, P. A., Aziz, H. M., Sabir, B. Y., Sorguli, S., & Anwar, G. (2021). *Hotel Service Quality: The Impact of Servic*

(PDF) *A Conceptual Model of Service Quality and Its Implications for Future Research.* (n.d.).ResearchGate.

[https://doi.org/10.2307/1251430?uid=25404&uid=3737976&uid=2&uid=5910312&uid=3&uid=25392&uid=67&uid=62&sid=21103987774637ource=gb\\_s\\_api](https://doi.org/10.2307/1251430?uid=25404&uid=3737976&uid=2&uid=5910312&uid=3&uid=25392&uid=67&uid=62&sid=21103987774637ource=gb_s_api)

(PDF) *a conceptual model of service quality and its implications for ...* (n.d.). Retrieved January 7, 2023, from

[https://www.researchgate.net/publication/305764085\\_A\\_Conceptual\\_Model\\_of\\_Service\\_Quality\\_and\\_Its\\_Implications\\_for\\_Future\\_Research](https://www.researchgate.net/publication/305764085_A_Conceptual_Model_of_Service_Quality_and_Its_Implications_for_Future_Research)

(PDF) *service quality and its dimensions - researchgate.* (n.d.). Retrieved January 7, 2023, from

[https://www.researchgate.net/publication/333058377\\_SERVICE\\_QUALITY\\_AND\\_ITS\\_DIMENSIONS](https://www.researchgate.net/publication/333058377_SERVICE_QUALITY_AND_ITS_DIMENSIONS)

# Understanding The Effectiveness of Marketing Communication Towards Tourist Decision-Making to Visit Min House Camp

*Nurhazirah Binti Jabir, Nurhidayah Binti Mohamad Nasir, Nurnadhirah Binti Muhamad, Nurul Afiqah Binti Shamsuddin & Nurul Aziah Binti Ahmad\**

*Faculty of Hospitality, Tourism and Wellness, Universiti Malaysia Kelantan*  
*Corresponding email: [nurulaziah@umk.edu.my](mailto:nurulaziah@umk.edu.my)*

---

## ABSTRACT

*The purpose of this study is to find out the effects of communication marketing on a tourist attraction. The practice of communication marketing is very common today among businesspeople. Understanding how marketing communication works and how successful marketing communication may improve interactions between consumers and brands is essential. Understanding the marketing promotion mix, as well as integrating marketing communication in the settings of brand building and consumer contact, are critical components of modern marketing communication. A quantitative study was conducted to identify The Impact of Communication Marketing Promoting Tourist Destinations in Min House Camp, Kota Bharu, Kelantan. Data were collected from 103 respondents using convenience sampling and analyzed using the BMI SPSS 27 version. The study's conclusions demonstrate that the majority of visitors are familiar with the destination because of its social media communication marketing plan.*

**Keywords: Sales Promotion, Advertising, Interactive Marketing, Tourist Decision Making, Min House Camp**

---

## INTRODUCTION

Marketing communication plays a crucial role in achieving company objectives, particularly in driving sales growth, which has a significant influence on the overall profitability and sustainability of the organization (Martin, Javalgi, & Ciravegna, 2020; Porcu, del Barrio-Garca, Kitchen, & Tourky, 2019). Effective communication, coupled with a well-designed management plan, is essential in promoting tourism sites and engaging prospective tourists (Wu, 2018; Kozak & Buhalis, 2019; Yousaf & Xiucheng, 2018). To educate, convincingly convince, and remind prospective tourists, both domestic and foreign, about the advantages and benefits of a tourist destination, whether directly or indirectly (Lee & Syah, 2018; Mustafa, 2019), a decent, helpful, and deep interaction pattern is required. In theory, communication marketing methods can help businesses target and grow new market segments while also correcting negative public relations caused by bad events (Dore and Crouch, 2015). Contrary to popular belief, requires a long battle and represents a difficulty in merging a variety of diverse perceptions that attempt to gather interests in resolving conflicts of interest between

each stakeholder (Dorn, 2015). As a result, for destinations to profit from a larger portion of global tourism, as witnessed today, the development and promotion of local products must be accelerated. This product, also known as a tourist product, is critical for destination marketing since it shapes people's impressions of a region, as well as their decisions and behavior towards it. The tourism product, according to Bhaita (2016), is not the tourist destination, but rather the experience of the area and what happens there. The tourism industry contributes 56.5 billion in national income while also becoming Malaysia's second biggest industry, therefore this study is considered significant to promote Malaysian tourism destinations more efficiently and effectively using elements in marketing communication. Therefore, the main focus of this study is to find out the effectiveness of marketing communication towards tourist decision-making in choosing Min House Camp as their preference. There were three objectives of this research:

RO1: To determine the relationship between sales promotion towards decision-making in choosing Min House Camp as their preferred destination.

RO2: To examine the relationship between advertising towards decision-making in choosing Min House Camp as their preferred destination.

RO3: To examine the relationship between interactive marketing and decision-making in choosing Min House Camp as their preferred destination.

## **SIGNIFICANCE OF THE STUDY**

Researchers have investigated the connections between various factors, such as sales promotion, advertising, and interactive marketing, within marketing communication. These variables have been found to influence the decision-making process of tourists. The findings of this study are expected to provide a valuable solution for marketing communication consumption. Not only will this benefit future researchers, but it will also be advantageous for students at Universiti Malaysia Kelantan, City Campus, and other individuals interested in this field of study.

## **LITERATURE REVIEW**

### **Sales Promotion**

The extremely competitive economy encourages sellers to constantly employ various marketing tactics and strategies to acquire new customers and boost an enterprise's profitability. One of the most effective approaches to attracting new customers and retaining existing ones is through the implementation of sales promotions. These marketing initiatives aim to temporarily enhance the value of products, encouraging consumer purchases and improving the effectiveness of intermediaries. A questionnaire was used in the study, which involved 60 men and women between the ages of 18 and 64. The study confirms that sales promotion is an effective tool that has a positive effect on consumer purchasing behavior. According to the study's findings, all methods and means of consumer sales promotion are effective because 21% of respondents are more likely to purchase 59% of respondents would gain from a product's promotion. The Internet, which is utilized by 82.5% of consumers, and promotional brochures provided by sellers, which are used by 77.2% of customers, are the two most popular communication channels used by consumers to learn about various promotional activities. (Evgheni Genchev, Gergana Torova, 2017).



## **Advertising**

Advertising is seen to function as one of the special branches which is through an object and places the importance of learning social communication in advertising. In these few decades, the study of advertising is not very widespread and only limited to the field of marketing. In the limited area of advertising-related writing, the focus is more on consumer misrepresentation that may be justified but rather unfounded. In this literature review, this aspect proves that the most irrelevant and interesting thing that we can ask the question of advertising is whether it moves the product. Aspects in this chapter summarize that advertising must be achieved as a body of social institutions and intermediaries in which social correction (William Leiss, Stephen Kline, Sut Jhally, Jacqueline Botterill, Kyle Asquith, 2018).

## **Interactive Marketing**

Interactive online media is a form of structure that consumers and advertisers are increasingly interested in. In addition, interactive marketing can improve online video ads that can skip more widely and it is something normal in social media networks such as YouTube. The specific elements and consequences of this interactive marketing tool require further evaluation and advice. By focusing on methods that have an interesting effect, this journal examines the consequences of high stimulation and low stimulation on an advertisement, namely advertisement attitude, brand, and interference with advertisements, with the ability to moderate the coherence of aspects and products. Consumer products determine that ad interruptions can skip high and low stimulation. This invention, along with its practical implications for the novel, provides a subsequent guide for research as well (Daniel Blanche, Carlos Flavián, Alfredo Pérez-Rueda, 2017).

## **Research Hypothesis**

Based on the discussion above, the hypothesis of the study is proposed below:

- H<sub>1</sub>**: There is a positive relationship between sales promotion and tourist decision-making.
- H<sub>2</sub>**: There is a positive relationship between advertising and tourist decision-making.
- H<sub>3</sub>**: There is a positive relationship between interactive marketing and tourist decision-making.

## Research Framework

Figure 1 below shows the research framework used for this study:

Figure 1: Framework

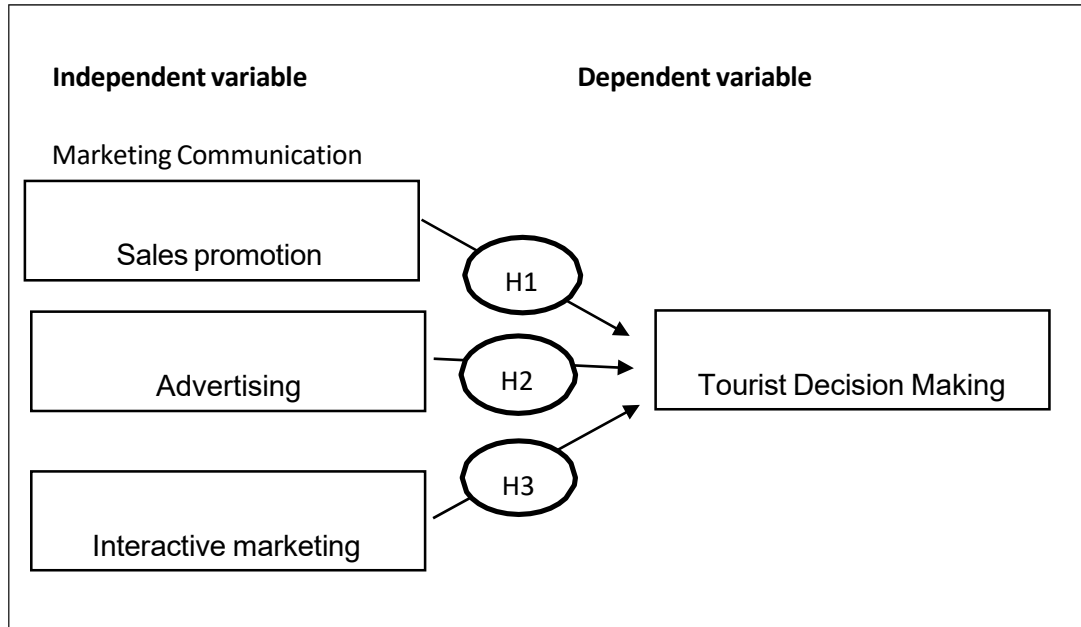

## METHODOLOGY

### Research Design

The research discusses the importance of study design in research methodology. A well-planned study design ensures that the chosen research methodologies align with the research objectives and facilitate effective data collection and analysis. The three types of research designs mentioned are exploratory, descriptive, and causal. The research in question follows a quantitative approach and utilizes a survey conducted through questionnaires. Specifically, it employs a descriptive research methodology, which focuses on describing the characteristics of the population or phenomenon being studied. The quantitative research design is deemed essential for organizational growth, and the questionnaire is designed to gather information related to the research objectives. The demographic section of the questionnaire offers multiple options for respondents to choose from. The quantitative data acquired by the survey is used in this assessment technique. The survey includes age, gender, ethnicity, and other factors. 103 students who visited Min House Camp from Universiti Malaysia Kelantan, City Campus will be among the approximately 103 respondents whose responses will be chosen for this study.

### Data Collection

In this study, researchers utilized primary data as a form of data-gathering approach. Primary data refers to raw data that is collected specifically for the study. It is considered a secure data collection method as researchers have control over the source and compilation of the information. To collect data for this study, researchers employed the questionnaire approach. Questionnaires were chosen because they offer a faster response rate

from a larger number of respondents compared to other methods. This approach ensures more accurate and reliable results for the entire research project. The questionnaire was administered online, providing convenience to respondents and enabling them to answer without any strain. This method also facilitates the provision of honest and accurate information.

Additionally, secondary data analysis, which involves utilizing existing data, was employed as a quick and cost-effective means to gather information from various sources. Secondary data, often referred to as data analysis, can be a valuable tool in research projects. In this study, secondary data was obtained from academic journals, handbooks, and databases like Google Scholar. These sources of secondary data contributed to the research design and complemented the primary data collected through questionnaires.

### **Sampling**

Researchers will use convenience sampling in this study. Convenience sampling is a non-probability sampling method where units are selected for inclusion in the sample because they are the easiest for the researcher to access. Since each respondent has an equal chance of being chosen, researchers will utilize convenience sampling to choose several respondents. Students from the Universiti Malaysia Kelantan, City Campus, were chosen as respondents. The total number of respondents is 103 students who were chosen to answer the questions to help researchers collect data regarding the research topic being researched. The reason why researchers chose students in Universiti Malaysia Kelantan, City Campus as respondents is that they usually visit or are familiar with Min House Camp.

### **Data Analysis**

This section provides an overview of the key information utilized in the research and aims to discuss the research hypotheses and objectives. It includes tables, charts, and graphs that present the data analysis, statistical findings, and conclusions of the research study. The main analyses employed in this study are reliability testing, Pearson correlation, and descriptive statistics.

The data collected from the questionnaire was structured, edited, categorized, and coded by the researcher using computer tools such as the Statistical Package for the Social Sciences (SPSS). This software facilitates quick data calculations and enables faster and less demanding quantitative investigations. Various statistical techniques, including descriptive analysis, reliability analysis, and Pearson's correlation coefficient, were employed in this study. These analyses helped evaluate the relationship between variables and explore the respondents' demographic information.

Reliability statistics were utilized to assess the significance of the relationship between variables in the study, while Pearson's correlation coefficient was employed to analyze the independent variable and examine the data (Bewick et al., 2003). By utilizing data sources, researchers were able to assess the logical conclusions derived from the use of this computer program.

## **FINDINGS**

### **Results of Frequency Analysis**

Table 1 shows the result of the frequency analysis of respondents. Most of the respondents were female 68 respondents (66%) while the male is 35 respondents (34%).

The majority of the respondents are females which consists of 66% more than male 34%. After that, the respondents age, most of them are at the age of 21-29 years old which is 74.1% of the total sample and followed by the ages 30-39 years old (11.5%), 40-49 years old (10.7%) and 60 years and above (2.9%). The lowest frequency of respondents' age is below 20 years old with 1.9%.

In terms of race, the highest number of respondents is Malay with 77.9%. Chinese and Indian share the same percentage which is both 9.6%. The race of others race gives the lowest frequency which is 2.9%.

The religion that got the majority of the respondents is Muslim with 79.8%. Christian and Buddha share the same percentage which is 9.6%. The religion of the respondent that shows the lowest frequency is other religions which are 1%.

As for the level of education, 68.9% of Bachelor of Degrees are the majority of the total respondents out of 103. Level of education for a Master is (12.6%), Siil Pelajaran Malaysia (10.7%). 0.5% is the lowest frequency of the respondents that are for others' level of education.

For occupation, most of the respondents are students with 72.8% and followed by the private sector (10.7%), government employees (8.7%). However, the lowest frequency of the respondents for other occupations is 7.8%.

The country of origin that shows the highest is local people which is 75.5% and the lowest is the tourist which is 24.5%. Thus, the data accurately reflect the real demographic compilation of the effectiveness of marketing communication towards tourist decision-making to visit min house camp.

Table 1: Frequency Analysis

## DEMOGRAPHIC

Demographic	Category	Frequency (N)	Percentage (%)
Gender	Female	68	66
	Male	35	34
Age	Below 20 years	2	1.9
	21-29 years	77	74.1
	30-39 years	12	11.5
	40-49 years	10	9.6
	60 years and above	3	2.9
Race	Malay	81	77.9
	Chinese	10	9.6
	Indian	10	9.6
	Others	3	2.9
Religion	Muslim	83	79.8
	Christian	10	9.6
	Buddha	10	9.6
	Others	1	1
Education Level	Sijil Pelajaran Malaysia	11	10.7
	Bachelor of Degree	71	68.9
	Master	13	12.6
	Others	8	7.8
Occupation	Student	75	72.8
	Government Employee	9	8.7
	Private Sector	11	10.7
	Others	8	7.8
Country of Origin	Local People	77	75.5
	Tourist	25	24.5

## Result of Descriptive Analysis

Table 2 shows the result of the descriptive analysis of the variable.

Table 2: Descriptive Analysis

Variable	Items	Mean Score	Standard Deviation
Sales Promotion	Sales promotion further strengthens the decision of tourists to Min House Camp	4.38	0.756
	Sales promotion gives satisfaction to the decision of tourists to Min House Camp	4.37	0.741
	Sales promotions make it easier for tourists to go to Min House Camp.	4.35	0.750
	Sales promotion attracts more tourists to Min House Camp	4.45	0.696
	Sales promotions bring excitement to tourists to Min House Camp	4.40	0.662
	Sales promotion further increases tourist visits from abroad to Min House Camp.	4.42	0.761
Advertising	Do you believe that advertising influences how people make decisions?	4.45	0.737
	Did the advertisement change your opinion and prejudices about Min House Camp?	4.44	0.696
	Do you think there are benefits from the advertisement about Min House Camp?	4.38	0.742
	Is the advertisement for Min House Camp believable?	4.33	0.733
	Advertisements on social media for Min House Camp are annoying/irritating?	3.47	1.533
	The product information provided about Min House Camp in the advertisement is relevant?	4.31	0.728

	The design of the advertisement attracts me while I am searching for information about Min House Camp on the Internet.	4.39	0.717
Interactive Marketing	Have you been interested in interactive marketing materials released by Min House Camp for example on social media ads?	4.31	0.741
	In your opinion, Min House Camp's interactive marketing materials are more persuasive than other forms of marketing.	4.30	0.739
	Is interactive marketing important to you when planning about wanting to travel to Min House Camp?	4.36	0.698
	Do you believe that interactive marketing materials have the appeal to shape your perception of choosing a destination for Min House Camp?	4.34	0.735
	Would you recommend the Min House Camp destination to others based on your experience with interactive marketing materials?	4.37	0.714
Tourist decision-making	The beauty of the flora and fauna found at Min House Camp can attract me to visit it.	4.46	0.683
	Min House Camp has offer lower and more reasonable daily prices to tourists.	4.27	0.795
	Min House Camp is an attraction for tourism that can involve the community	4.37	0.671
	Will you visit again to Min House Camp?	4.40	0.676
	Will you recommend Min House Camp to your friend or relatives to visit Min House Camp?	4.43	0.762

### Result of Reliability Test

The reliability analysis results for the dependent variable and independent variable are presented in Table 3. The Cronbach's Alpha value, which measures the internal consistency of the scale, falls within the acceptable range of 0.60 to 0.90.

Table 3: Result of Reliability Test

Variable	Number of question	Reliability Cronbach's Alpha	Comment
Sales Promotion	6	0.944	Excellent
Advertising	7	0.874	Very good
Interactive Marketing	5	0.912	Excellent
Decision Making	5	0.933	Excellent

### Results of Pearson Correlation Analysis

Table 4 shows the result of Pearson Correlation Analysis to see the relationship of each predictor with tourist decision-making consumption. According to the results, there are three factors (sales promotion, advertising, and interactive marketing knowledge about tourist decision-making effectiveness) that have a positive significant relationship with tourist decision-making consumption since the p-value is less than 0.05. The Pearson correlation value of sales promotion ( $r = 0.794$ ), advertising (0.814), and interactive marketing (0.852) indicate a positive high relationship with tourist decision-making consumption.

Table 4: Pearson Correlation Analysis

Predictors	Pearson Correlation	P-Value
Sales Promotion	.794**	.000
Advertising	.814**	.000
Interactive Marketing	.852**	.000



## **Results Of Hypothesis Testing**

H1: There is a significant relationship between sales promotion and marketing promotion toward tourist decision-making in choosing Min House Camp as their preferred destination.

The correlation between sales promotion and marketing promotion toward tourist decision-making in choosing Min House Camp as their preferred destination is 0.794 which is considered as a strong positive correlation. Moreover, effectiveness has shown a positive significant relationship toward tourist decision-making in choosing Min House Camp as their preferred destination since the p-value is less than 0.05. H1 is supported.

H2: There is a significant relationship between advertising and marketing promotion toward tourist decision-making in choosing Min House Camp as their preferred destination.

Advertising and marketing promotion toward tourist decision-making in choosing Min House Camp as their preferred destination showed 0.814 indicating a moderately strong positive correlation. In addition, quality of service has shown a positive significant relationship toward tourist decision-making in choosing Min House Camp as their preferred destination since the p-value is less than 0.05. H2 is supported.

H3: There is a significant relationship between interactive marketing and marketing promotion toward tourist decision-making in choosing Min House Camp as their preferred destination.

Interactive marketing and marketing promotion toward tourist decision-making in choosing Min House Camp as their preferred destination with 0.852 indicated a moderate positive correlation. Furthermore, interactive marketing has shown a positive significant relationship toward tourist decision-making in choosing Min House Camp as their preferred destination since the p-value is less than 0.05. H3 is supported.

## **DISCUSSION AND RECOMMENDATION**

The researcher highlights the importance of following proper procedures in research while acknowledging the presence of unavoidable constraints. One limitation mentioned is the difficulty some respondents face in understanding the questionnaire, emphasizing the need for clear explanations from the researcher. Another limitation is the reluctance of certain individuals to participate in the questionnaire due to concerns about sharing opinions, lack of interest, and perceived time consumption. The COVID-19 pandemic further complicates data collection, as online administration of the questionnaire takes more time to gather sufficient responses. Many respondents tend to ignore or skip questionnaires shared through social media platforms. The summary emphasizes the importance of dedication and collaboration among the research team and the respondents to successfully conduct the survey and manage the workload effectively.

The researcher suggests that tourism operators should play a vital role in attracting tourists to revive the tourism industry, emphasizing the importance of excellent facilities and infrastructure at the destination. The study focuses on the effectiveness of marketing communication in influencing tourists' decisions to choose the Min House Camp as their preferred destination. Recommendations are provided for future research, and the study can serve as a reference for exploring digitalization methods in attracting tourists to the camp.

The use of both quantitative and qualitative research methods enhances the study's accuracy by considering different perspectives. Quantitative research involves the collection and analysis of numerical data to identify trends, formulate hypotheses, examine causality, and make generalizations. It emphasizes precise measurements and statistical analyses using surveys, polls, and computational techniques. This approach allows for a better understanding of specific events and enables broader generalizations across different groups of individuals.

## **CONCLUSION**

The research aims to explore the effectiveness of marketing communication in influencing tourist decision-making regarding visits to the Min House Camp. The independent variables under investigation include sales promotion, advertising, and interactive marketing. These variables collectively impact the dependent variable, which is tourist decision-making. The study's findings reveal a significant relationship between the three independent variables and the dependent variable. The analysis of the results was conducted using the Statistical Package for Social Science (SPSS). However, the research encountered limitations arising from factors such as limited understanding, lack of interest among respondents, and time constraints. To enhance future research, it is recommended to incorporate additional demographic characteristics of the respondents and considers utilizing multiple languages.

## REFERENCES

- Akter, M., Sadekin, M. N., & Patwary, A. K. (2020). An Empirical Study on Students' Satisfaction from Mawlana Bhashani Science & Technology University, Bangladesh. *Review of Economics and Development Studies*, 6(2), 363-379.
- Alom, S., Patwary, A. K., & Khan, M. M. H. (2019). Factors affecting the turnover intention of Bangladeshi migrants in the United Arab Emirates: An empirical study on the hotel industry. *International Journal of Innovation, Creativity and Change*, 8(3), 344-360.
- Anvari, F., & Lakens, D. (2021). Using anchor-based methods to determine the smallest effect size of interest. *Journal of Experimental Social Psychology*, 96, 104159. <https://doi.org/10.1016/j.jesp.2021.104159>
- Denys, V., & Mendes, J. (n.d.). *Consumption Values and Destination Evaluation in Destination Decision Making*. *Journal of Spatial and Organizational Dynamics*. Retrieved January 7, 2023, from <https://www.jsod-cieo.net/journal/index.php/jsod/article/view/19>
- Factors Influencing Visitors in Choosing the Ecotourism Sites: The Study of MinHouse Camp, Kubang Kerian, Kelantan, Malaysia*. (2019). NURTURING HOSPITALITY, TOURISM AND WELLNESS WORLD, 1. <http://myscholar.umk.edu.my/bitstream/123456789/1659/1/E-PROCEEDING%20%283rd%20HOSPITALITY%2C%20TOURISM%20%26%20WELLNESS%20COLLOQUIUM%29%20HOSPITALITY-VOLUME%201.pdf#page=8>
- Fengmin, Z., Baijun, W., Jiangtao, B., Li, L., & Patwary, A. K. (2022). Investigating revisit intention of medical tourists in China through nutritional knowledge, perceived medical quality, and trust in the physiologist: A recommendation on health tourism policy measures. *Frontiers in Public Health*, 10, 893497.
- Font, X., & McCabe, S. (2017, April 12). Sustainability and marketing in tourism: its contexts, paradoxes, approaches, challenges and potential. *Taylor Francis Online*, 25, 869-883. <https://doi.org/10.1080/09669582.2017.1301721>
- Hazbar, A. M. H., Alem Mohammed, A., & Karim, A. K. A. (2019). An Empirical Study of Factors Influencing hotel customers' online booking Intention. *مجلة العلوم التربوية و الدراسات الإنسانية*, (5), 1-17.
- Kerdpitak, C. (2022, may 10). *Marketing Effectiveness Model of Tourism Business in Thailand*. <http://www.jonuns.com/index.php/journal/article/view/1028>
- Korea Science*. (n.d.). KoreaScience. Retrieved January 7, 2023, from <https://koreascience.kr/article/JAKO202014862061596.page>
- Kotler, P. (1998). *Marketing management – Analysis, planning, implementation, and control*. (9th ed.). Englewood Cliffs: Prentice-Hall.
- Kotler, P. (2006). *Marketing Management*. New Jersey: Person Education.
- Kotler, P., & Armstrong, G. (2010). *Principles of marketing*. (13th Global Edition). Englewood Cliffs: Prentice Hall.
- Kotler, P., & Keller, K. L. (2009). *Marketing management*. (13th Pearson International Ed.). Englewood Cliffs: Prentice Hall.
- Lee, M., Sandler, D., & Shani, D. (1997). Attitudinal constructs towards sponsorship. *International Marketing Review*, 14(3), 159-169. <http://dx.doi.org/10.1108/02651339710170230>

- Li, L., Ragavan, N. A., Patwary, A. K., & Baijun, W. (2022). Measuring patients' satisfaction toward health tourism in Malaysia through hospital environment, nutritional advice, and perceived value: A study on Chinese exchange students. *Frontiers in public health*, 10, 893439.
- Li, L., Wu, B., & Patwary, A. K. (2022). How marine tourism promote financial development in sustainable economy: new evidences from South Asia and implications to future tourism students. *Environmental Science and Pollution Research*, 29, 1155-1172.
- Li, L., Wu, B., & Patwary, A. K. (2022). The psychosocial factors affecting chinese Outbound Exchange and mobility students' academic performance during COVID-19. *Frontiers in psychology*, 13, 872516.
- Malhotra, N., & Birks, D. (2006). *Marketing research: An applied approach*. New Jersey: Pearson Education Ltd
- Marketing Communication and Synergy of Pentahelix Strategy on Satisfaction and Sustainable Tourism -The Journal of Asian Finance, Economics and Business*
- McDonagh, P. (2010, February 1). *Towards a theory of Sustainable Communication in Risk Society: Relating issues of sustainability to marketing communications*. Taylor and Francis. Retrieved January 7, 2023, from <https://www.tandfonline.com/doi/abs/10.1362/026725798784867699>
- Mcshane, S. L., & Glinow, V. (2000). *Organizational behavior*. New York: Irwin/McGraw Hill.
- Palmer, A. (2005). *Principles of service marketing*. (4th ed.). Berkshire: McGraw- Hill Education
- Smith, P., Berry C., & Pulford, A. (1997). *Strategic marketing communications*. London: Kogan Page Ltd.
- Patwary, A. K., Roy, B., Hoque, R., & Khandakar, M. S. A. (2019). Process of developing a community based tourism and identifying its economic and social impacts: An Empirical study on Cox's Bazar, Bangladesh. *Pakistan Journal of Humanities and Social Sciences*, 7(1), 1-13.
- Sumethokula, P., Patwary, A. K., Srinuanpanc, B., Srinuanpand, C., Suwandee, P., Thammathikulf, A., & Phanong, W. (2020). The potential of new tour repackaging for creative tourism among entrepreneurs in Nakhon Si Thammarat. *International Journal of Innovation, Creativity and Change*, 13(10), 1752-1771.
- Wu, B., Liu, S., Wang, J., Tahir, S., & Patwary, A. K. (2021). Assessing the mechanism of energy efficiency and energy poverty alleviation based on environmental regulation policy measures. *Environmental Science and Pollution Research*, 28, 40858-40870.
- Wu, B., Zhai, B., Mu, H., Peng, X., Wang, C., & Patwary, A. K. (2021). Evaluating an economic application of renewable generated hydrogen: A way forward for green economic performance and policy measures. *Environmental Science and Pollution Research*, 1-15.

# FACTOR AFFECTING TOURIST DEVELOPMENT IN KELANTANAFTER COVID-19

**\*Ms. Zaimatul Binti Awang, Nurul Ain Binti Romli, Nurul Aina Binti Rosli, Nurul Aina Afifah Binti Halim, Nurul Amirah Binti Hamid**

*Faculty of Hospitality, Tourism and Wellness, Universiti Malaysia Kelantan*

*Corresponding email: [h20a1646@siswa.umk.edu.my](mailto:h20a1646@siswa.umk.edu.my)*

---

## ABSTRACT

*The tourism sector in Malaysia faced a serious threat from the covid-19 outbreak in the early months of 2020. The covid-19 epidemic has had an impact on millions of people's lives worldwide. The development of tourism will be most impacted by the onset and spread of COVID-19. As nations throughout the world continue to impose travel restrictions and close their borders, the market for tourism services like resorts is dropping (The Star 2020). For instance, it can be argued that practically all resort reservations have been cancelled in Kelantan. This paper examines the technology, facilities and social factors of tourism development in tourist arrival. There are three objectives of this research. Which is to investigate the relationship between technology and the tourism development in tourist Arrival, to identify the relationship between facilities and the tourism development in tourist arrival. The third objective is to determine the relationship between social factors and the tourism development in tourist arrival. This study used a quantitative technique, and it included primary data from the self-administered questionnaire as well as secondary sources to do the literature review.*

**Keywords: Resort, Tourism, Kelantan, Covid-19**

---

## INTRODUCTION

The COVID-19 Pandemic has impacted both the worldwide supply and demand for goods and services. Domestic travel makes up around 75% of the sector in countries where tourism is projected to fall sharply (Razak, 2020). The complex and challenging demand would decrease as a result of foreign buyers postponing or cancelling purchases, domestic and foreign visitors postponing visits, and stock market decreases (Salman et al., 2021).

The effects of the Covid-19 outbreak have been felt most strongly in the tourism sector. Due to the explanation that resorts cannot thrive during or after these pandemics, this outbreak has also caused individuals to postpone travel and resort reservations (Baker and Judge, 2020). After the Movement Control Order (MCO) was withdrawn, several resort enterprises that were

unfortunate and struggling to exist will have to close. In Malaysia, the first Covid-19 wave caused resort services to be discontinued for several months.

## **SIGNIFICANCE OF THE STUDY**

This study looked into changes in tourism development in Kelantan before and after the conflict. The report can serve as a resource for other studies looking to examine the growth of local tourism in Kelantan. This report aids in understanding the minor factors influencing Kelantan's tourist development.

## **LITERATURE REVIEW**

### **Technology**

Technology is basically anything that enables us as humans to make all of those things, including all tools, machinery, tools, apparatus, weaponry, shelter, clothes, transport, and communication gadgets. The future of modern society and the national economy are both at risk due to the globalization of climate change (Urry 2015). Therefore, it is not surprising that studies have linked people to the direct drivers of this extraordinary transformation as a result of our activities (Cloern et al. 2016, 513-29; Cavicchioli et al. 2019, 569-586).

The technology that we will adapt to this study is green technology. Sustainability is crucial since it may cut down on environmental degradation, wasteful outputs, and unneeded losses (Hornig 2017). In the hospitality and tourism sectors, green technology innovation has made a significant contribution to lowering resource consumption and environmental pollution during industry development (Yousaf 2021).

### **Facilities**

According to Atkins and Brooks, (2004) facilities are an integrated strategy to manage, maintain, enhance, and change an organization's buildings and infrastructures in order to produce an environment that strongly supports the organization's key objectives. According to Sulastiyono (2007:3), a resort is a place to stay that offers amenities like lodging, food and drink, and other services like a sports court and laundry. Another definition of a resort given by Steadmon (2003:8) in Fadmawati is an establishment whose main business is to offer lodging to the general public and which offers one or more of the following services.

Yoeti (1995:111) asserts that a resort needs to meet four requirements in order to be considered. These include physical facilities, the calibre of the goods and services, the attitudes of the employees, and competitive pricing. Property, equipment, and services make up the three main parts of facilities management, according to Abd Rahman (2002). Each of these components is handled and made available to users by the appropriate management.

## Social Factor

When underprivileged groups participate in tourism activities, social and financial measures are used to encourage this type of tourism, which is known as "social tourism" (Haulot, 1982). The local culture is crucial in conveying to tourists that cultural practices are part of daily life there. Additionally, as a society, individuals must accept the culture that newcomers bring and merely regard their traditions as temporary visitors (Raden Ismail, R. M. F. H., Jusoh, N. A. S. & Rohiat, M. A.) (2021). Socially factors are things that affect someone's lifestyle. These could include wealth, religion, buying habits, education level, family size and structure and population density (globalizationpartners.com/2016/06/09/).

The accessibility of travel information, the comfort of the gear, and the upbeat attitudes of the family, friends, and locals will all contribute to the environment. Encourage those with mobility issues to go on more trips (Lei, 2010). Instead of that, knowing accessible information improved their journey enjoyment. Even if the destination is inaccessible but they truly want to go, there are still ways for them to arrange it and have a good trip (Lei, 2010).

## Tourist Arrival

Because tourist attractions can attract random visitors to a destination (McKercher, 2017), individual perceptions of an attraction's ability to meet visitor needs and travel motivations drive attraction selection (Leiper, 1990). However, travelers usually don't have enough background knowledge to make all the travel arrangements. Extensive information about tourist attractions, including their characteristics, alternative options, and other contextual factors, is required to support decision-making and shape expectations for future experiences.

According Lim, C., & McAleer, M. (2001) If the mean and variance of a series of tourist arrivals remain constant throughout time, the series is considered to be stationary. Governments and commercial businesses all over the world are eager to increase tourism as the number of visitors rises.

## Research Framework

The researchers have proposed a framework to study the technology, facilities and social factors of tourism development in tourist arrival., based on the previous literature review. Hence, as seen below, the structure:

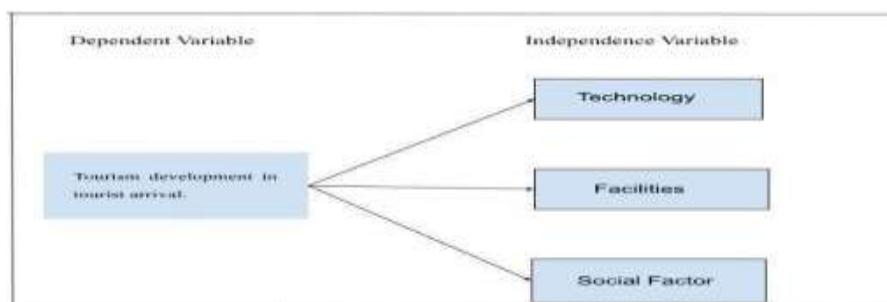

Figure 1: Proposed Research Model

## **METHODOLOGY Research Design**

A quantitative approach has been applied into this research and it involves secondary sources in order to perform the literature and primary data from the self-administered questionnaire. Quantitative research, according to Van der Merwe (1996), is a research strategy used to analyse ideas, find facts, show correlations between variables, and forecast outcomes. In quantitative research, natural science approaches are employed to establish validity, generality, and consistency (Weinreich, 2009). The methods used in quantitative research involve a systematic questionnaire, an intervention to test predefined hypotheses regarding the relationships between particular variables, and an independent random selection of research respondents from the study population.

### **Data Collection**

To collect data for this study, the researcher employed the questionnaire approach. Questionnaires are chosen because, compared to other methods, they can generate a quick response from a large number of respondents and provide more accurate and dependable results for the entire research project. Data will be collected based on questions related to tourism development, attraction and accommodation that will be selected. We do the data online, we will provide a Google Form and blast to tourists who visit Kelantan using online platforms such as group communities in Facebook WhatsApp, and Telegram. Then we will change to QR code for easy provided to tourist scan and answer question for easy they understanding what we want to know and ask.

### **Sampling**

The simple sampling technique was employed in this study. Sample describes a portion of the population. The subject was referred to as the sample participant, and the sample size is the total number of people included in the sample. According to Krejcie (1970), for population in Kelantan starting from 20 until 44 years old is around 750, the required sample was 254 respondents.

### **Data Analysis**

This study employs four types of data analysis: frequency analysis, descriptive analysis, reliability analysis, and Spearman correlation coefficient analysis. The collected data is then analysed using the Statistical Package for the Social Sciences (SPSS). To begin, the current study examined the response rate, the respondents' demographics and other information, nonresponse bias, and the data's validity and reliability. This includes statistical calculations such as the average and distribution of frequency and percentage of information provided by questionnaire respondents.



## FINDINGS

### Demographic Analysis

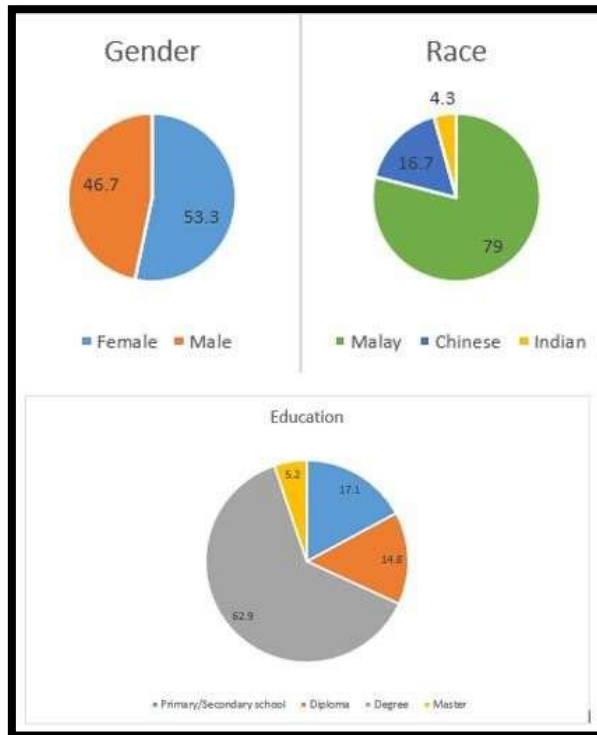

**Table 1: Demographic analysis**

The study of a population based on characteristics like age, race, and sex is known as demographic analysis. Socioeconomic information expressed statistically, such as employment, education, income, marriage rates, birth and death rates, and more, is referred to as demographic data. nonetheless, we only mention three, namely gender, race, and education. The first one is gender, shows that the respondents are male with 46.7% with 98 respondents and for female 53.3% which is 112 respondents. The second is race, the highest respondents is Malay, 79% with 166 respondents. This is followed by Indians 16.7% (35 respondents) and Chinese 4.3% the lowest with 9 respondents only. The last one is education, according to the chart the highest percentage 62.9% for degree which is 132 respondents. Also followed by Primary/Secondary School 17.1% with 36 respondents and Diploma get 14.8% (31 respondents). So lastly Master with 5.2% (11 respondents).

## Descriptive Analysis

Content (DV)	Mean	Std. Deviation
Satisfied with all the services provided in resort.	4.16	.770
will come frequently to resort due to the availability of accommodation provided	4.13	.771
will recommend family and friends to come to resort	4.12	.779
The friendliness of resort staff made me like and come to the resort	4.00	.920
The culture in Kelantan made me come to Kelantan	4.06	.886
I like the interesting places in Kelantan	4.17	.788
I will come to Kelantan frequently.	3.92	.975

Content (IV1)	Mean	Std. Deviation
The application on the phone can make matters easier to book a resort	4.35	.782
The resort's internet facilities are acceptable	4.12	.797
Social Media help to ease access the information about resort	4.34	.715
contactless payment can make payment matters easier	4.35	.775
The filled data has been saved to make things easier if repeat the resort	4.14	.833
Green technology used by the resort can attract more tourists.	4.17	.845
Satisfied with the technology provided by the resort.	4.20	.709

Content (IV2)	Mean	Std. Deviation
The facilities offered at the resort can be an attraction for visitors	4.24	.753
The resort's facilities, such as computers, laptops, and projectors, are ideal for holding meetings, seminars, and important events.	4.14	.786
Pool areas, toilets, and even showers are clean and safe to use.	4.24	.752
Visitors could be attracted to resorts that have recreational facilities.	4.33	.760
The provision of adequate parking facilities and a wide area	4.26	.789
Rooms include facilities such as a television, a telephone, and an internet connection	4.30	.784
The facilities provided at the resort are satisfied	4.23	.735

Content (IV3)	Mean	Std. Deviation
always search the resort want to go and stay in social media	4.25	.763
The main reason I came to Kelantan is because of their traditional food culture.	4.09	.856
What has been portrayed in social media same with my expectations	4.00	.844
I mostly travel because I want to release my stress.	4.25	.794
I enjoy the experience of cultural activities held in resort.	4.10	.818
I travel because of outstanding natural resources available at the resort.	4.12	.838
The experience I get at the resort is value for money	4.10	.819

**Table 2: Descriptive Analysis**

Table 2 shown descriptive analysis that utilising both recent and old data to find patterns and connections is known as descriptive analytics. It describes trends and associations but doesn't delve deeper, earning it the moniker "the simplest form of data analysis." In this research, researchers provide seven question for dependent variable and seven question for each independent variable. So total overall is 28 question

## Reliability Analysis

Variable	Number of items	Reliability Cronbach's Alpha	Comment
Tourist Arrival	7	0.929	Excellent
Technology	7	0.940	Excellent
Facilities	7	0.946	Excellent
Social	7	0.926	Excellent

**Table 3: Reliability Analysis**

The significance of both independent and dependent variables in this study was shown in Table 3 of the SPSS results. Table 4.3.2 shows that all variables were more than 0.900. The survey received approval. The seven questions were used to evaluate how the entry of tourists affected Kelantan's tourism industry before and after COVID-19. The Cronbach Alpha score of 0.929 has been demonstrated to be very high. The Cronbach's Alpha score for the technology questions was 0.940, and the coefficient obtained was also precise. The Cronbach Alpha result is also 0.946 after seven questions were used to compute the variable for facilities in tourist development. Last but not least, seven questions were utilised to determine the social impact of tourism development, and the Cronbach Alpha result was 0.926, which was considered excellent.

## Pearson Correlation Analysis

Hypothesis	Pearson's Correlation Results	
H1: Technology - tourist development in tourist arrival	$r=0.780, p<0.05$	Hypothesis accepted
H2: Facilities - tourist development in tourist arrival	$r=0.788, p<0.05$	Hypothesis accepted
H3: Social factors - tourist development in tourist arrival	$r=0.835, p<0.05$	Hypothesis accepted

**Table 4: Pearson Correlation Analysis**

Based on Table 4, it can be seen that the hypothesis regarding the impact of technology, facilities, and social variables on tourism development on visitor arrival was evaluated using Pearson's correlation analysis. All offered hypotheses were accepted at the 0.05 level of significance. Furthermore, the conclusion demonstrated that independent variables, including technology, facilities, and social factors, had a very strong and high positive connection with tourism development, supporting the entire premise.

## **DISCUSSION AND RECOMMENDATION**

The study's findings show that factor affecting tourist development in Kelantan before and after covid-19. The economy of the world benefits enormously from tourism. It is because, since 2013, a sizable portion of jobs has come from the tourism industry. However, the tourism business is in danger as a result of Covid-19, which has harmed the population. As a result, the informants were questioned to learn more about their difficulties and strategies for solving the issue. During the Covid-19 pandemic, those would become the most contaminated industries. Human travel restrictions are crucial for limiting the spread of Covid-19, but they will also have an impact on the world economy and tourism growth (Gaffney et al., 2020). This crisis is more likely to have an impact on nations whose economies rely more heavily on tourism (Fernandes, 2020).

It is hoped that the suggestions presented in this paper will help the relevant stakeholders enhance resort operations so that visitors are happy while also opening up opportunities for bringing in more visitors in the future. There have been several studies on resorts, but their disparate findings ultimately give rise to further questions for future research. However, the sample size in this study was modest. Therefore, it is strongly recommended that researchers use a large sample size for subsequent studies. This is so that the larger samples more closely reflect the population. The aspects could be explored in future studies which is choose a specific topic on research, establish a strategy, and build the same research in a different setting, locale, or culture.

## **CONCLUSION**

The COVID-19 pandemic has affected the demand and supply of goods and services worldwide. The impact of the Covid-19 epidemic has been felt most strongly in the tourism industry. This study compared the changes in tourist development in Kelantan before and after the war, when holiday services were banned for several months during the first wave of Covid19 in Malaysia.. The report can be a resource for other studies on local tourism growth in Kelantan. This report helps to understand the minor factors affecting tourism development in Kelantan. In the hospitality and tourism sector, green technological innovations have helped to significantly reduce resource consumption and environmental pollution during the development of the industry (Yousaf 2021). A resort, according to Steadmon (2003:8) in Fadmawat, is a facility whose main business is providing lodging to the general public and which offers one or more of the following services.

A resort must have four elements or basic criteria. These are physical infrastructure and facilities, quality of products and services, attitude of staff and competitive price. Local culture plays a key role in letting tourists know that cultural practices are part of everyday life there. The availability of travel information, the comfort of equipment and the cheerful attitude of family, friends and local people contribute to the environment. Comprehensive information about tourist destinations, including their characteristics, alternative options and other contextual factors, is necessary to support decision-making and form expectations about future experiences.

## REFERENCES

- Akter, M., Sadekin, M. N., & Patwary, A. K. (2020). An Empirical Study on Students' Satisfaction from Mawlana Bhashani Science & Technology University, Bangladesh. *Review of Economics and Development Studies*, 6(2), 363-379.
- Alom, S., Patwary, A. K., & Khan, M. M. H. (2019). Factors affecting the turnover intention of Bangladeshi migrants in the United Arab Emirates: An empirical study on the hotel industry. *International Journal of Innovation, Creativity and Change*, 8(3), 344-360.
- Facilities Management Practices in Malaysia: A Literature Review. (n.d.). Cyberleninka.org. Retrieved January 6, 2023, from <https://cyberleninka.org/article/n/719032/viewer>
- Fengmin, Z., Baijun, W., Jiangtao, B., Li, L., & Patwary, A. K. (2022). Investigating revisit intention of medical tourists in China through nutritional knowledge, perceived medical quality, and trust in the physiologist: A recommendation on health tourism policy measures. *Frontiers in Public Health*, 10, 893497.
- Foo, L. P., Chin, M. Y., Tan, K. L., & Phuah, K. T. (2020). *The impact of COVID-19 on the tourism industry in Malaysia. Current Issues in Tourism*, 24(19), 1–5. <https://doi.org/10.1080/13683500.2020.1777951>
- Hazbar, A. M. H., Alem Mohammed, A., & Karim, A. K. A. (2019). An Empirical Study of Factors Influencing hotel customers' online booking Intention. *مجلة العلوم التربوية و الدراسات الإنسانية*, (5), 1-17.
- Li, L., Ragavan, N. A., Patwary, A. K., & Baijun, W. (2022). Measuring patients' satisfaction toward health tourism in Malaysia through hospital environment, nutritional advice, and perceived value: A study on Chinese exchange students. *Frontiers in public health*, 10, 893439.
- Li, L., Wu, B., & Patwary, A. K. (2022). How marine tourism promote financial development in sustainable economy: new evidences from South Asia and implications to future tourism students. *Environmental Science and Pollution Research*, 29, 1155-1172.
- Li, L., Wu, B., & Patwary, A. K. (2022). The psychosocial factors affecting chinese Outbound Exchange and mobility students' academic performance during COVID-19. *Frontiers in psychology*, 13, 872516.
- Lim, Christine; McAleer, Michael (2000). A seasonal analysis of Asian tourist arrivals to Australia. *Applied Economics*, 32(4), 499–509. <https://scihub.hkvisa.net/10.1080/000368400322660>
- N. H. A., Razaai, N. H., Mohd Hatta, S. K., & Grafius, D. (2022). Spatial Distribution of COVID-19 Infected Cases in Kelantan, Malaysia. *Sustainability*, 14(21), 14150. <https://doi.org/10.3390/su142114150>
- Nor, A. N. M., Jamil, R. M., Aziz, H. A., Abas, M. A., Hambali, K. A., Hassin, N. H., Abdul Karim, M. F., Nawawi, S. A., Amir, A., Amaludin, N. A., Ibrahim, N., Yusoff, A. H., Malek,
- Oh, H., Jeong, M., & Baloglu, S. (2013). Tourists' adoption of self-service technologies at resort hotels. *Journal of Business Research*, 66(6), 692–699. <https://doi.org/10.1016/j.jbusres.2011.09.005>

- OlakanmiJohn, A. (2019). Achieving Aesthetics using Landscape Design in Resort Environment. *International Journal for Research in Applied Science and Engineering Technology*. <https://www.semanticscholar.org/paper/Achieving-Aesthetics-using-LandscapeDesign-in-OlakanmiJohn/af70206c98c1f6bd92cdfb6899477db8ac97e704>
- Patwary, A. K., Roy, B., Hoque, R., & Khandakar, M. S. A. (2019). Process of developing a community based tourism and identifying its economic and social impacts: An Empirical study on Cox's Bazar, Bangladesh. *Pakistan Journal of Humanities and Social Sciences*, 7(1), 1-13.
- Sumethokula, P., Patwary, A. K., Srinuanpanc, B., Srinuanpand, C., Suwandeee, P., Thammathikulf, A., & Phanong, W. (2020). The potential of new tour repackaging for creative tourism among entrepreneurs in Nakhon Si Thammarat. *International Journal of Innovation, Creativity and Change*, 13(10), 1752-1771.
- Wu, B., Liu, S., Wang, J., Tahir, S., & Patwary, A. K. (2021). Assessing the mechanism of energy efficiency and energy poverty alleviation based on environmental regulation policy measures. *Environmental Science and Pollution Research*, 28, 40858-40870.
- Wu, B., Zhai, B., Mu, H., Peng, X., Wang, C., & Patwary, A. K. (2021). Evaluating an economic application of renewable generated hydrogen: A way forward for green economic performance and policy measures. *Environmental Science and Pollution Research*, 1-15.

# THE FACTORS INFLUENCING THE TOURISM DEVELOPMENT IN GENTING HIGHLAND

*Nurul Awanis Uweishah Binti Mat Noor, Nurul Athirah Binti Azman, Nurul Ayu Wahidah Binti Hanifah, Nurul Arisya Binti Mohamad Ali & \*Zaimatul Awang*  
*Faculty of Hospitality, Tourism and Wellness, Universiti Malaysia Kelantan*  
*Corresponding email: [zaimatul@umk.edu.my](mailto:zaimatul@umk.edu.my)*

---

## ABSTRACT

This research aims to investigate the relationship between facilities, safety and security, and services in Genting Highland and their impact on tourism development. The main objective is to identify the factors influencing tourism in Genting Highland. The study will utilize quantitative methods, including convenience, safety, security, and hospitality as factors, and will gather data through a questionnaire. Statistical analysis will be conducted using SPSS version 26.0 to support decision-making and improve performance. The research intends to achieve its objective of understanding the development of tourism in Genting Highland.

**Keywords:** Genting Highland, tourism development, facility, service, safety and security.

---

## INTRODUCTION

For this study researcher focuses on identifying the factors that may be influenced by tourism growth. The survey conducted provides insights into the tourism industry in the Genting Highlands area, including leisure and travel sectors such as lodging, retail, ecotourism, cruise tourism, spa and wellness, gastronomy, and domestic and international travel (PEMANDU,2013). Genting Highlands has a history of updates and new amenities, planning to reopen in 2020 and welcoming tourists from mid-2021. COVID-19 has affected all countries, but its impact on Genting Highlands is minor as it primarily affects Malaysians (Genting Berhad, 2020). The study aims to examine the relationship between tourism development and factors like amenities, safety, and security, with the goal of finding solutions to potential challenges. The study specifically evaluates the factors influencing the tourism development in Genting Highland.

## SIGNIFICANCE OF THE STUDY

### Researchers



This study will assist researchers in determining the factors influencing tourism development in Genting Highland in terms of facility, safety and security, and service. Therefore, this will be a tool that will guide and navigate them when they find reliable factors known as data needed for deeper learning of the topic.

### **Community**

This study will help tourism players to overcome this problem to modify the industry. Then, suggestions on how to improve the performance of tourism development in Genting Highland.

### **Government**

This study also helps the government restore development by promoting Genting Highland to increase revenue. The results enable Genting Berhad to improve the quality of places and services to attract and retain new or existing tourists. In conclusion, it can also help increase their profit margins.

## **LITERATURE REVIEW**

### **i) Tourism Development**

Tourism development involves the process of increasing, developing, and promoting tourism in a destination to generate economic benefits. Genting Highlands in Malaysia is a popular tourist site known for its cool climate and outdoor theme park. Resort World Genting (RWG) plans to reopen in 2022 and expects 30 million visitors, capitalizing on the reopening of border gates and the anticipated population recovery. Sustainable tourism considers economic, social, and environmental effects, meeting the demands of guests, the industry, and host communities (Wahl, Lee & Jamal, 2020). Genting Highlands, located 35 kilometers from Kuala Lumpur, offers a range of tourism options, including hotels, casinos, shopping centers, and the Skyworlds Theme Park. The area also features surrounding valley attractions, such as rural villages, culinary hotspots, and natural destinations. The strategic location and continuous growth of Genting Highlands contribute to its stable tourism industry. Tourism development involves planning strategies to maximize tourism's positive impact on human welfare and environmental quality (Pearce, 1989).

### **ii) Facility**

Tourist facilities, such as accommodations, hotels, theme parks, and transportation services, play a crucial role in the development of tourism in Genting Highlands. These facilities support the growth of the tourism and recreation sector and enhance the overall visitor experience. Sustainable tourism practices, including long-term environmental planning and the utilization of regional public infrastructure, can guide the placement of facilities and increase visitor satisfaction

(Chi et al., 2005; Ramasamy, 1994). Transportation systems, including buses and cable cars, are available to transport visitors to Genting Highlands, while lodging options like hotels provide comfortable stays. The Outdoor and Indoor Theme Parks offer a wide range of thrilling attractions for visitors of all ages. Understanding the relationship between facilities and tourism development is essential for maximizing the potential of Genting Highlands as a tourist destination.

### **iii) Service**

A service is an intangible action or benefit provided by one person to another, not resulting in ownership, according to Kotler and Armstrong (2019). Services encompass various industries such as accounting, banking, education, transportation, and hotels. In Genting Highlands, the hotel business plays a significant role in promoting development, offering excellent service and hospitality to guests. The region features a range of accommodations, from budget rooms to luxurious five-star hotels. Additionally, Genting Highlands offers a theme park, shopping centers, entertainment venues, and a casino. Quality is recognized as an important aspect of services, contributing to operational effectiveness and financial success. This study aims to explore the relationship between services and tourism development in Genting Highlands.

### **iv) Safety And Security**

Safety and security are essential aspects of tourism, with safety focusing on protection against accidental incidents and security addressing deliberate acts (Albrechtsen, 2003). Concerns about safety and security significantly influence tourists' travel choices (Spencer and Tarlow, 2021; Wang et al., 2019). Genting Highlands has implemented strict health and safety measures to prioritize the well-being of employees and guests, particularly in response to the COVID-19 pandemic. The region emphasizes the significance of tourism safety and security for the quality of tourism. Visitors seek secure settings for relaxation, tranquility, and adventure. Resorts World Genting has installed thermal scanners and implemented protocols to monitor body temperature and track visitors. Safety is the top priority, and rigorous onboarding processes were enforced during the Movement Control Order to ensure the safety of guests. According to researchers Kovari and Zimányi (2010), safety and security are crucial components of the economy and tourism, and this study explores their interaction with tourism development. Adequate security measures are necessary at tourist destinations to guarantee visitor safety. The study aims to investigate the relationship between safety, security, and tourism development in Genting Highlands.

## RESEARCH OBJECTIVE

There are 3 objectives that this study aims to achieve as follow:

1. To determine the relationship between facility and development in Genting Highland.
2. To determine the relationship between safety and security and tourism development in Genting Highland.
3. To determine the relationship between services and tourism development in Genting Highland.

## RESEARCH QUESTIONS

The questions for this study are as follows:

1. What is the relationship between facilities and tourism development in Genting Highland?
2. How does tourist find out the safety & security level of tourism development in Genting Highland?
3. What is the level of services and tourism development of Genting Highland?

## RESEARCH HYPOTHESIS

A hypothesis must be testable and realistic, taking into account the most recent findings and research methods. Furthermore, a hypothesis is a prediction or an explanation of how two variables are related. It implies that a dependent variable and an independent variable are connected predictably. As a result, the

### Hypothesis 1 :

$H_0$ : There is no relationship between facility and tourism development in Genting Highland.

$H_1$ : There is a relationship between facility and tourism development in Genting Highland.

CORRELATIONS			
		Facility	Tourism Development
Facility	Pearson Correlation	1	.452**

	Sig. (2-tailed)		<.001
	N	300	300
<b>Tourism Development</b>	Pearson Correlation	.452**	1
	Sig. (2-tailed)	<.001	
	N	300	300
**Correlation is significant at the 0.01 level (2-tailed)			

### Hypothesis 2 :

$H_0$ : There is no relationship between level of services and tourism development in Genting Highland.

$H_3$ : There is a relationship between level of services and tourism development in Genting Highland.

<b>CORRELATIONS</b>			
		<b>Safety &amp; Security</b>	<b>Tourism Development</b>
<b>Safet &amp; Security</b>	Pearson Correlation	1	.664**
	Sig. (2-tailed)		<.001
	N	300	300
<b>Tourism Development</b>	Pearson Correlation	.664**	1
	Sig. (2-tailed)	<.001	
	N	300	300
**Correlation is significant at the 0.01 level (2-tailed)			

### Hypothesis 3 :

$H_0$  : There is no relationship between safety & security and tourism development in Genting Highland.

$H_2$ : There is a relationship between safety & security and tourism development in Genting Highland.

CORRELATIONS			
		Safety & Security	Tourism Development
Safet & Security	Pearson Correlation	1	.620**
	Sig. (2-tailed)		<.001
	N	300	300
Tourism Development	Pearson Correlation	.620**	1
	Sig. (2-tailed)	<.001	
	N	300	300

\*\*Correlation is significant at the 0.01 level (2-tailed)

## RESEARCH FRAMEWORK

The conceptual framework for this research is seen in Figure 1. The three factors that make up the independent variables are facility, safety and security, and service. Tourism development in Genting Highland is the dependent variable.

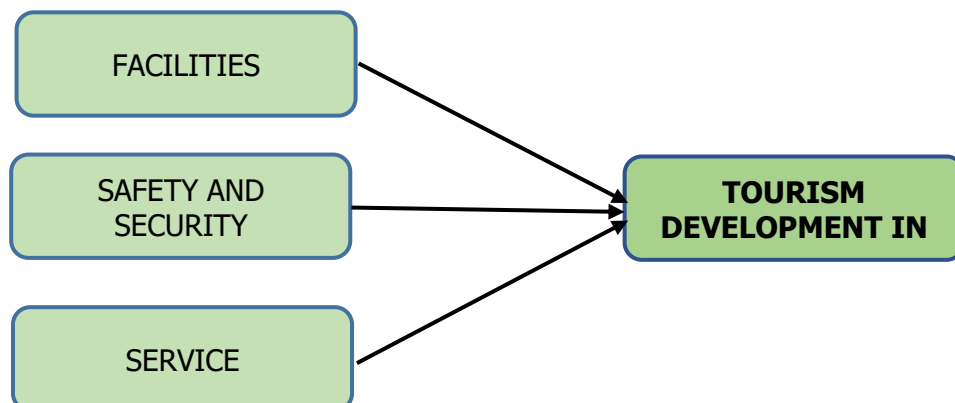

**Figure 2 : Conceptual Framework of the relationship between facility, safety and security, and service with tourism development in Genting Highland**

## **METHODOLOGY**

### **Research Design**

The study incorporates the factor influencing the tourism development in Genting Highland. A quantitative technique is used in this study, and data will be collected from individual using a self-administered questionnaires (Pritha Bhandari, 2022). The relationship between facilities, service and safety and security toward the tourism development in Genting Highland us the subject of a descriptive study. The descriptive study design assists in answering the research questions and achieving research objective.

This study used quantitative method via statistics through the use of large scale survey research to collect the data distributing a set of questionnaire through Google Form. The questionnaire are designed related to facilities, service and safety and service and the tourism development in Genting Highland using 5-point Linkert scale (1=strongly disagree and 5 strongly agree).

### **Population And Sample Size**

Overall, the population of arrival tourists to Genting Highland is 2,369,121 million. However, the researches population of this study only involves the tourists from January to June 2022. To determine the sample size, Krejcie and Morgan (1970) sample was used in this study.

<i>N</i>	<i>S</i>	<i>N</i>	<i>S</i>	<i>N</i>	<i>S</i>
10	10	220	140	1200	291
15	14	230	144	1300	297
20	19	240	148	1400	302
25	24	250	152	1500	306
30	28	260	155	1600	310
35	32	270	159	1700	313
40	36	280	162	1800	317
45	40	290	165	1900	320
50	44	300	169	2000	322
55	48	320	175	2200	327
60	52	340	181	2400	331
65	56	360	186	2600	335
70	59	380	191	2800	338
75	63	400	196	3000	341
80	66	420	201	3200	346
85	70	440	205	4000	351
90	73	460	210	4500	354
95	76	480	214	5000	357
100	80	500	217	6000	361
110	86	550	226	7000	364
120	92	600	234	8000	367
130	97	650	242	9000	368
140	103	700	248	10000	370
150	108	750	254	15000	375
160	113	800	260	20000	377
170	118	850	265	30000	379
180	123	900	269	40000	380
190	127	950	274	50000	381
200	132	1000	278	75000	382
210	136	1100	285	100000	384

Note — *N* is population size. *S* is sample size.  
Source: Krejcie & Morgan, 1970

**Figure 3 : Krejcie & Morgan (1970) :**

### Data Collection

In the first stage, the data collection method that had been used is online surveys using Google Forms. The reasons why the researchers used this platform is due free access and user-friendly. It also makes it easier to the researchers to collect all data from local tourist. The second stage is the study executed a pilot study whereby 30 respondents participated in the survey. Subsequently, the study conducted a field study whereby based on the required sample size, 384 tourists participated in this survey.

### Sampling

Sampling is a method for collecting data in the academic world that allows researchers to learn more about a population by examining the results of a representative sample of people rather than concentrating on a small number of individuals (Turner, 2020). Probability sampling and non-probability sampling are the two major sampling methodologies used in this study. Probability sampling means that every item in the population has an equal chance of being included in the sample. One way to undertake random sampling would be if the researcher constructed a sampling frame first

and then used a random number generation computer program to pick a sample from the sampling frame (Zikmund, 2002). Non-probability sampling is often associated with case study research design and qualitative research.

Convenience sampling will be used in this research for the participants' convenience. Convenience sampling is a non-probability sampling strategy in which respondents are chosen for sampling just because they provide researchers with "convenient" sources of data.

## **RESEARCH INSTRUMENTS**

This research instrument aims to assess user satisfaction in a specific public facility. It consists of five sections: demographic information, facilities evaluation, safety and security assessment, service quality evaluation, and development satisfaction. Each section utilizes a different type of scale or question format to gather data.

In this section, participants are asked to provide their demographic details such as gender, age, marital status, and education qualification. The open-ended scale allows respondents to provide detailed responses, providing researchers with a comprehensive understanding of the characteristics and backgrounds of the users.

The facilities evaluation section focuses on assessing users' perceptions of various aspects of the public facility. Participants are presented with five statements or questions related to facility conditions, such as cleanliness, maintenance, availability of amenities, ease of access, and overall ambiance. They are then asked to rate their level of agreement or satisfaction on a Likert scale, typically ranging from 1 (Strongly Disagree) to 5 (Strongly Agree). This scale allows for the quantification of satisfaction levels across different aspects of the facility.

The safety and security section aims to evaluate users' perceptions of safety measures in the public facility. It consists of five statements or questions related to security effectiveness, presence of surveillance systems, emergency response readiness, and overall sense of safety. Participants rate their level of agreement or satisfaction using a Likert scale, similar to the facilities evaluation section.

The service quality section focuses on assessing users' satisfaction with the services provided by the public facility. It includes five statements or questions related to staff friendliness, responsiveness, professionalism, accuracy of information provided, and overall service experience. Participants rate their level of agreement or satisfaction using a Likert scale.



The development satisfaction section measures users' satisfaction with the development initiatives within the public facility. It includes five statements or questions related to the availability and quality of additional features, ongoing improvements, and overall perception of progress. Participants rate their level of agreement or satisfaction on a Likert scale.

By employing a combination of open-ended questions for demographic information and Likert scale questions for evaluating facility conditions, safety and security, service quality, and development satisfaction, this research instrument provides a comprehensive approach to assessing user satisfaction in the public facility. The collected data can then be analyzed to identify areas of strength and areas for improvement, guiding decision-making and future development strategies.

### Data Analysis

Researchers used Social Science Statistic Package (SPSS) in this study to examine the data collected from the respondent. SPSS is a program-based data processing and analysis window that allows the users to create distribution charts and plots as well as execute complex data processing and analysis with only a few simple keystrokes. This researchers used descriptive statistics, reliability tests, and Pearson's correlation coefficient for the analysis of the results.

### FINDINGS

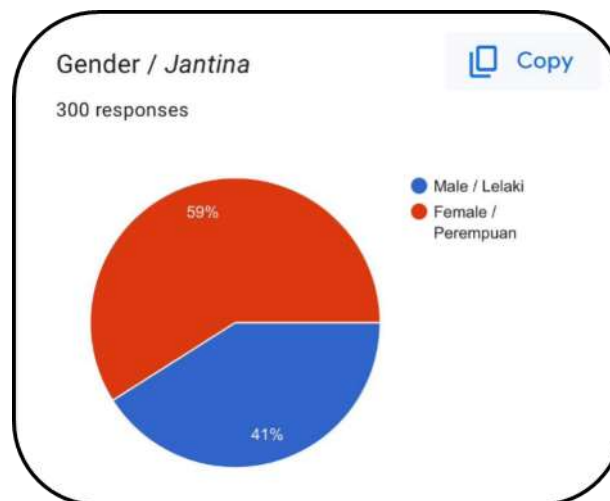

Based on the gender distribution of the 300 respondents, the higher percentage is represented by females at 59%, while males account for the lower percentage at 41%.

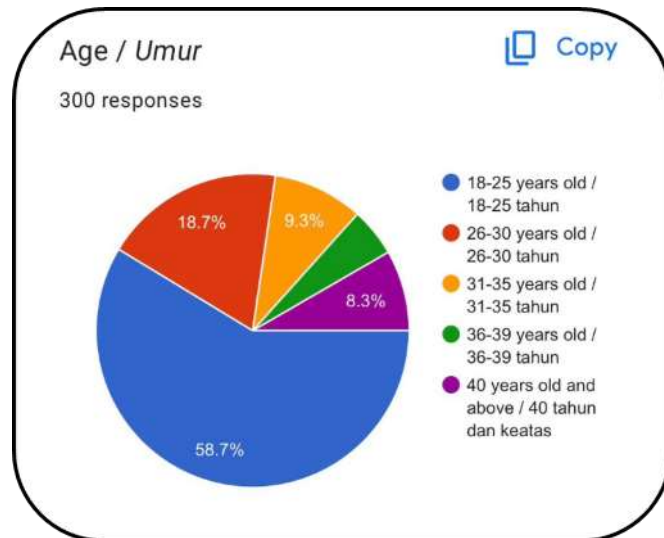

Based on the age distribution of the 300 respondents, the highest percentage falls within the 18-25 years old category at 58.7%. The lowest percentage is represented by the 36-39 years old category, accounting for 5% of the respondents.

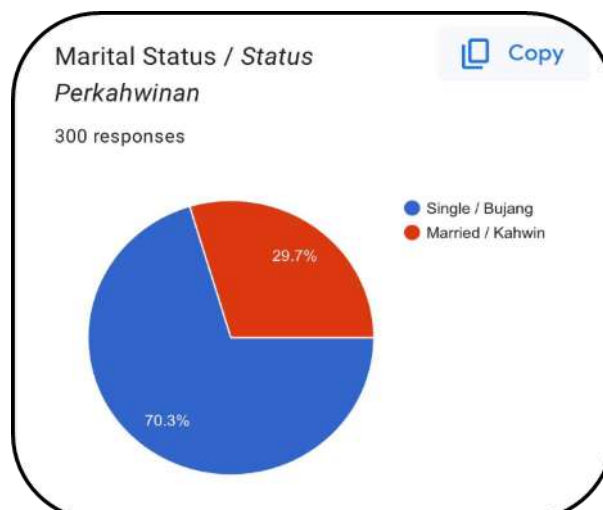

Among the marital statuses mentioned, the highest percentage is represented by the "single" category, accounting for 70.3% of the respondents. On the other hand, the lowest percentage is attributed to the "married" category, with only 29.7% of the respondents reporting being married.

Among the mentioned, the highest by individuals with a 61.7% of the hand, the lowest individuals with a master's degree or PhD, accounting for 5.7% of the respondents.



educational qualifications percentage is represented bachelor's degree at respondents. On the other percentage is attributed to

## DISCUSSION AND RECOMMENDATION

The discussions were aimed to solve the questions and address the hypothesis as mentioned in the first chapter of this study. In general, this study has extensively researched the factors influencing tourism development in Genting Highland. Based on the findings of the study, there are some recommendations for tourism operators as well as the future researchers in order to make an improvement in the future study.

The government should play an important role in ensuring that companies or institutions involved in the tourism industry can be given special allocations to redevelop businesses affected by Covid-19. As happened with the Genting Highland company they had to invest with a large investment to redevelop the areas affected by Covid-19. The government should take swift action in helping this company, this is because Genting Highland is a large tourism center and has always been attention from tourists and investors from home and abroad. Therefore, the sensitivity of the government in helping tourism companies like Genting Highland is very important because this is the main attraction for tourists to our country.

Next, the proposed improvement to redevelop Genting Highland after the Covid-19 pandemic is to relax some of the regulations in Genting Highland such as the Covid-19 Regulations which are too strict and many result in tourists and customers in Genting Highland not having fun when doing activities because they are bound by various new regulations. Therefore, the Genting Highland side should also make an arbitration regarding the rules that have been made to ensure that the visitors feel more enjoyable when they are in Genting Highland.

## CONCLUSION

Genting highland is the biggest attraction in attracting foreign tourists to come and travel to the country. However, since the outbreak of the covid-19 outbreak, the rate of operation and movement of Genting Highlands has declined and resulted in huge losses. In addition, the uncertain global economic problem is also the cause of the decline of the highland business itself. Nevertheless, planning and research has been done in redeveloping the economy and operating system affected by this epidemic. Various steps and efforts are being taken to redevelop the development in Genting Highlands in order to attract domestic and foreign tourists to visit Genting Highlands

## REFERENCES

- Akter, M., Sadekin, M. N., & Patwary, A. K. (2020). An Empirical Study on Students' Satisfaction from Mawlana Bhashani Science & Technology University, Bangladesh. *Review of Economics and Development Studies*, 6(2), 363-379.
- Alom, S., Patwary, A. K., & Khan, M. M. H. (2019). Factors affecting the turnover intention of Bangladeshi migrants in the United Arab Emirates: An empirical study on the hotel industry. *International Journal of Innovation, Creativity and Change*, 8(3), 344-360.
- Annual Reports. (n.d.). Retrieved January 7, 2023, from [https://www.genting.com/annual\\_reports/](https://www.genting.com/annual_reports/)
- Bhargava, V. (2019, December 21). What is Service: Definitions, Concept, Characteristics, Classification, Role. Retrieved January 7, 2023, from <https://www.businessmanagementideas.com/service-marketing/what-is-service/20967>
- Definition of the concept of safety | INSPQ. (2018, August 17). Retrieved January 7, 2023, from <https://www.inspq.qc.ca/en/quebec-collaborating-centre-safety-promotion-and-injury-prevention/definition-concept-safety>
- Fengmin, Z., Baijun, W., Jiangtao, B., Li, L., & Patwary, A. K. (2022). Investigating revisit intention of medical tourists in China through nutritional knowledge, perceived medical quality, and trust in the physician: A recommendation on health tourism policy measures. *Frontiers in Public Health*, 10, 893497.
- Hazbar, A. M. H., Alem Mohammed, A., & Karim, A. K. A. (2019). An Empirical Study of Factors Influencing hotel customers' online booking Intention. *مجلة العلوم التربوية و الدراسات الإنسانية*, (5), 1-17.
- Li, L., Ragavan, N. A., Patwary, A. K., & Baijun, W. (2022). Measuring patients' satisfaction toward health tourism in Malaysia through hospital environment, nutritional advice, and perceived value: A study on Chinese exchange students. *Frontiers in public health*, 10, 893439.
- Li, L., Wu, B., & Patwary, A. K. (2022). How marine tourism promote financial development in sustainable economy: new evidences from South Asia and implications to future tourism students. *Environmental Science and Pollution Research*, 29, 1155-1172.
- Li, L., Wu, B., & Patwary, A. K. (2022). The psychosocial factors affecting chinese Outbound Exchange and mobility students' academic performance during COVID-19. *Frontiers in psychology*, 13, 872516.
- Patwary, A. K., Roy, B., Hoque, R., & Khandakar, M. S. A. (2019). Process of developing a community based tourism and identifying its economic and social impacts: An Empirical

- study on Cox's Bazar, Bangladesh. *Pakistan Journal of Humanities and Social Sciences*, 7(1), 1-13.
- PEMANDU (2013). Revving up the tourism industry: Economic transformation programme – a roadmap for Malaysia. Retrieved from [http://etp.pemandu.gov.my/Download\\_Centre-@-Download\\_Centre.aspx](http://etp.pemandu.gov.my/Download_Centre-@-Download_Centre.aspx)
- Preko, A., & Gyepi-Garbrah, T. F. (2021). Understanding sense of safety and trustworthiness of tourism information among migrant visitors. *International Hospitality Review*. <https://www.emerald.com/insight/content/doi/10.1108/IHR-04-2021-0029/full/pdf?title=understanding-sense-of-safety-and-trustworthiness-of-tourism-information-among-migrant-visitors>
- Sumethokula, P., Patwary, A. K., Srinuanpanc, B., Srinuanpand, C., Suwandee, P., Thammathikul, A., & Phanong, W. (2020). The potential of new tour repackaging for creative tourism among entrepreneurs in Nakhon Si Thammarat. *International Journal of Innovation, Creativity and Change*, 13(10), 1752-1771.
- What is Tourism Development | IGI Global. (n.d.). Retrieved January 7, 2023, from <https://www.igi-global.com/dictionary/the-engineering-of-territorial-tourism-study-case-of-algeria/49800#:~:text=Tourism%20development%20is%20the%20process%20of%20establishing%20and,plans%20to%20increase%2Fdevelop%2Fencourage%20tourism%20in%20a%20particular%20destination.>
- Why tourism planning is important - Tourism Teacher. (2019, April 25). Retrieved January 7, 2023, from <https://tourismteacher.com/why-tourism-development-planning-is-important/>
- Wu, B., Liu, S., Wang, J., Tahir, S., & Patwary, A. K. (2021). Assessing the mechanism of energy efficiency and energy poverty alleviation based on environmental regulation policy measures. *Environmental Science and Pollution Research*, 28, 40858-40870.
- Wu, B., Zhai, B., Mu, H., Peng, X., Wang, C., & Patwary, A. K. (2021). Evaluating an economic application of renewable generated hydrogen: A way forward for green economic performance and policy measures. *Environmental Science and Pollution Research*, 1-15.

# **The Factors Influencing Tourist Visitation Among Tourists A Case Study In Kelantan, Malaysia**

**Nurul Fazlina, Nurul Farhana Binti Zuraidi, Nurul Hidayah Binti Othman, Nurul Izzah Binti Zulkefli & \*Zaimatul Binti Awang\***

*Faculty of Hospitality, Tourism and Wellness, Universiti Malaysia Kelantan*

*Corresponding email: [h20a1670@siswa.umk.edu.my](mailto:h20a1670@siswa.umk.edu.my)*

---

## **ABSTRACT**

---

Tourism is one of the important industries in the country's economic development and almost every year shows an increase in the number of tourists. This growth is attributable to several government initiatives, including the Year of Visit Malaysia campaign, the encouragement of investment incentives, and the improvement of infrastructure that supports the growth of the nation's tourism industry. Tourism has also been identified as the main driver of the service industry, and it has also been recognized as a growing industry in several countries, such as Malaysia, Thailand, Spain, Greece, etc., because each of these countries has a large contribution to exchange remuneration foreigners and job opportunities. In addition, considering that countries in every corner of the world are experiencing a major crisis which is the COVID-19 pandemic, the arrival of tourists is decreasing due to the Movement Control Order (MCO) that has been issued by YAB Prime Minister of Malaysia. Malaysia. Therefore, efforts to increase the number of tourist arrivals are important to create sustainable tourism that continues and continues to progress so that the country can be competitive and maintain its place in the eyes of the world as a country that is the main choice of tourist destination. A total of 384 respondents participated to answer all questions in this survey. The independent variable which is Word-Of-Mouth received the highest mean score of 4.04 in data analysis and finding, indicating that this is the most important factor.

**Keywords:** Tourism, Tourist, Word-Of-Mouth

---

## **INTRODUCTION**

The United Nations World Tourism Organisation (UNWTO) has classified Malaysia as the 15th most tourist-friendly nation in the world (World Tourism Barometer, 2020). The State of Kelantan is no stranger to receiving visits from domestic and foreign tourists at any time, regardless of the school year or the holiday season, just like other states in Malaysia. In accordance with the vision and objective established by the state of Kelantan's tourism and

culture department, it is the goal of the Official Portal of the Kelantan State Government (2022) to make the state of Kelantan a successful tourist destination by concentrating particularly on cultural tourism. The primary goal of this study is to investigate the attitudes that affect travellers' intentions when selecting environmentally friendly local and international travel destinations, including environmental attitudes, motivation, destination image, and perception of quality through word of mouth (WOM). This study focuses on tourists visiting Kelantan, Malaysia, and seeks to understand how visitors move, their modes of travel, the services they use while travelling, and how these factors affect the tourist attractions, activities, and programmes. Several objectives of this study were established as follows:

1. To investigate the relationship between experience and tourist visitation in selecting sustainable tourism destinations in Kelantan.
2. To identify the relationship between destination image and tourist visitation in selecting sustainable tourism destinations in Kelantan.
3. To determine the relationship between Word-of-Mouth (WOM) and tourist visitation to in selecting sustainable tourism destination in Kelantan

### **SIGNIFICANCE OF THE STUDY**

The goal of this research is to make the new information easier to understand and include important knowledge about some recent studies or theses, as well as related websites, to meet the predicted interest of the people who will read it. This study gives advantages and opportunities to tourists to refer material for them to choose the tourist destination they want to go to, as well as all tourism institutes in Malaysia.

This study also continues the continuation of previous studies by examining the causes that influence tourists to come and travel, especially around the Kelantan area. Tourists have the right to make decisions about their travel destinations. In fact, this research can help them determine whether the location can meet the goals of the Malaysian tourism industry. Tourism institutes in Malaysia can analyze the percentage of tourists arriving at certain locations and create better packages and activities. Therefore, the results of this study will help the concerned parties in improving the tourism industry. In fact, this study aims to support the government's policy to improve the development of tourists in the eyes of the world.

## **LITERATURE REVIEW**

### **Tourist Visitation**

Tourism is a social, cultural, and economic activity involving people moving to foreign countries for pleasure, business, or professional reasons. Research by Gitelson and Crompton (1984) found five reasons why tourists return to a new location: risk reduction, familiar faces, emotion, exploration, and sharing. First-time and returning visitors have different motivations and efforts. First-time visitors seek new culture, experiences, while returning visitors seek leisure activities or quality time with friends and family. Tourism involves considering destinations beyond one's intention, and consciousness is crucial for emergence of desires or goals. Woodside and Sherrell's study argues that being aware of a location is the first step in a visit. Research reveals motivation, destination perception, and consumer feedback are crucial factors in travel decisions, as different destinations offer unique experiences. Tourism is a profitable industry for a country's economy, influenced by efforts from related parties and residents. Improvements in the destination attract visitors, and a sustainable tourism image can generate word of mouth and viral buzz.

### **Experience**

The term "tourist" originated in Stendhal's "Mémoires d'un touriste" in 1838. Early definitions defined tourists as temporary travellers from their homes or residences, spending money earned there. The UNWTO defined tourists as visitors in 1968. The tourism industry involves tourism, tourists, visitation, and experience, which are closely related. This study aims to explore the impact of experience on tourist visitation and sustainable tourism in Kelantan. Experience is a moment related to practical, intellectual, and adequate physical experiences that cannot be considered separate factors. It must be maintained and explained through mental construction. Recent philosophical phenomenology emphasizes that we are both subjects and subjects to experience. Experience surpasses cognitive construction, and an extraordinary learning experience may be more important than subject requirements. Experience is crucial for learning in science education, as adult students learn through their experiences. Homeostasis is closely tied to their experiences at the Science Centre. Involving children in science learning experiences can improve their skills and provide data. Analysing experience categories is crucial for addressing questions related to social theory, efforts, and the environment, providing



a holistic account of the relationship between individuals and the environment. A positive and unique customer experience can improve product and service quality, creating engagement between destinations and travellers. Traditional differentiation methods need to be engaged with the growing demand for experiential products that meet specific needs. A specific and relevant experience in the tourism industry can lead travellers to experience something different.

### **Destination Image**

Destination image encompasses tourists' perceptions, thoughts, and beliefs about a location, emphasizing its distinctiveness and allure. Tourists base their decisions on the perceived quality of the place, influencing their travel plans and pleasure. Kelantan's attractive beaches, such as Irama Beach, Senok Beach, Mr. Amat Beach, Kemayang Beach, and Cahaya Bulan Beach, are crucial in the tourism industry. Academics define destination image as a tourist's expectations, perceptions, and feelings towards a location, assessing their psychological and feelings. It encompasses objective knowledge, impressions, prejudice, ideas, and feelings, and can be difficult to define accurately. Recent tourism marketing guidelines emphasize that a tourist destination's image is influenced by consumer rationality and emotionality, with perceptual and cognitive factors being the main components. Attractions and attractions, as well as tourists' motivations, significantly impact the emotional component of the destination image.

### **Word-of-Mouth**

Word of Mouth Marketing (WOM) significantly influences consumer behaviour, with managers developing efficient marketing solutions. Travel businesses use website commenting systems to encourage consumers to share information on social media, helping tourism organizations attract travellers and offer memorable experiences. WOM can influence customer perceptions of quality, purchase intentions, expectations, and satisfaction, raising their worth and risk perceptions. As a result, tourism organizations can proceed with WOM development. The fall of word-of-mouth (WOM) is a social communication phenomenon that reduces information transmission from various sources, impacting consumer behaviour. Social media usage has led to an exponential rise in online information exchange and WOM. WOM is a crucial source of information for travellers when making decisions about destinations, as they rely on recommendations from friends and relatives. This shift in attitudes may shift customers' perception of WOM as non-commercial. The article highlights the importance of

World of Warcraft (WOM) in tourists' travel decisions, examining its role in moderating the relationship between perceived image and behavioural intention. WOM plays a crucial role in both promotion and suppression mechanisms, acting as a moderating variable. The research highlights trends for long-term growth in marketing initiatives in tourist destinations and adds to the WOM theory. Kelantan, a region with undiscovered natural beauty and a rich culture, is often mentioned as a destination with reduced prices and tax-free goods.

### Research Hypothesis

The hypothesis in the study is to find out whether there are any correlations or relationship between dependent variables and independent variables:

H1: There is a significant relationship between destination image and tourist visitation.

among tourists.

H2: There is a significant relationship between word-of-mouth and tourist visitation among

tourists.

H3: There is a significant relationship between experience and tourist visitation among

tourists.

### Research Framework

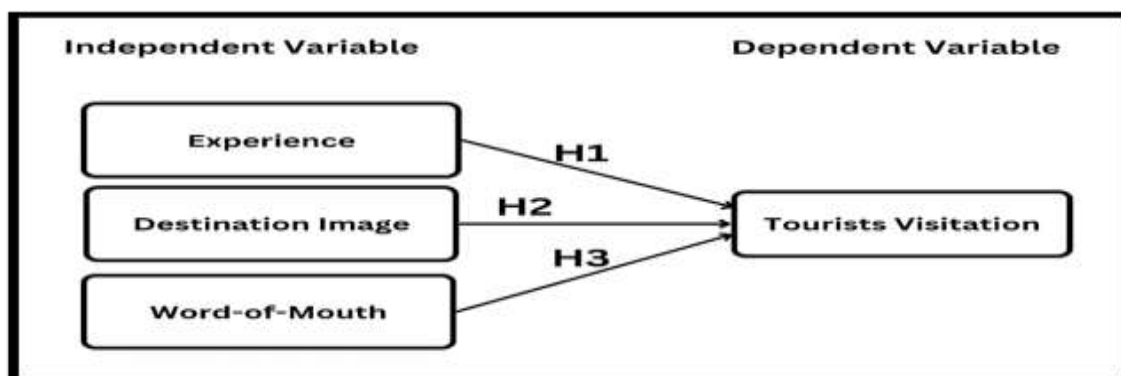

Table: Relationship between independent variables and dependent variables of tourist visitation in Kelantan.

## **METHODOLOGY**

### **Research Design**

This project publishes a set of questions on Google Forms to collect data using quantitative methods through statistics and large-scale survey research. Respondents were collected using a questionnaire. Using a 5-point Likert scale (1=strongly disagree and 5=strongly agree), the questionnaire was created about the experience, destination image, and word-of-mouth as a factor in the arrival of tourists travelling to Kelantan.

A hypothesis test study is the type of research design employed in this investigation. We picked hypothesis testing because it allows us to investigate the causal link between the independent and dependent variables using sample data. The connection between both dependent and independent factors is examined in this study. The experience destination image, and word-of-mouth are independent variables, while the dependent variable Is factors impacting traveller visit among travellers a Kelantan case study. This study is cross-sectional because data was only gathered once over several months. Since the target respondents for this study are tourists, the unit of analysis is one individual.

### **Data Collection**

In this study, data was collected using primary data. The tool we use in our research is a questionnaire in a Google form that we will ask respondents to answer. The questionnaire was used to collect information on factors that influence tourist visit among tourists a case study in Kelantan, Malaysia. The questionnaire has been distributed online and we will collect data from tourists who visit the state of Kelantan to make this data collection process successful. This is because tourists travelling in Kelantan are our sample size in this study.

In the first stage, this study carried out a pilot study in which 30 respondents participated in a survey. Next, the study conducted a field study were based on the required sample size, 384 tourists participated in this survey.

## Sampling

The researchers decided on non-probability sampling for this investigation. Convenience sampling is the sample technique that has been selected. Convenience sampling was selected for this study because it is simple, reasonably priced, and appropriate for this study. The researchers calculated the sample size using Krejcie and Morgan's (1970) equation to acquire a valid and trustworthy sample for this investigation. According to a table by Krejcie and Morgan (1970), the significant sample size that is suited for this research is 384 since tourist arrivals are more than that ( $N > 100\,000$ ).

## Data Analysis

This study used three different forms of data analysis: reliability tests, descriptive analysis, and Pearson's correlation. The Statistical Package for the Social Sciences (SPSS) was used to analyze the data acquired in order to demonstrate the links between the dependent variable and the independent variables as a collection of statistical processes roughly approximated by regression analysis.

## FINDINGS

**Table 1:** Findings For the factors affecting tourist visits among tourists in Kelantan, Malaysia.

<b>Demographic</b>	<b>Category</b>	<b>Frequency(N)</b>	<b>Percentage(%)</b>
<b>Gender</b>	<b>Female</b>	<b>260</b>	<b>59,5</b>
	<b>Male</b>	<b>124</b>	<b>28.4</b>
<b>Age</b>	<b>18-22 years old</b>	<b>83</b>	<b>19.0</b>
	<b>23-27 years old</b>	<b>243</b>	<b>55.6</b>
	<b>28-32 years old</b>	<b>38</b>	<b>8.7</b>
	<b>33-40 years old</b>	<b>11</b>	<b>2.5</b>
	<b>41 years old</b>	<b>9</b>	<b>2.1</b>
<b>Marital Status</b>	<b>Single</b>	<b>341</b>	<b>78.0</b>
	<b>Married</b>	<b>43</b>	<b>9.8</b>

Table 1 shows 384 respondent profiles, and most respondents are female (59.5% compared to 28.4% male). Following that, for respondents, who make up 55.6% of the sample and are primarily between the ages of 23 and 27, The respondent age with the lowest frequency is 41 years old (2.1%). Regarding race, Malay respondents make up the majority (65.9%). The least frequent category, with a frequency of 5.9%, is other people's race. In contrast, just 9.8% of respondents are married, making being single the most common marital status among respondents (78.0%). As a result, the data provides an accurate reflection of the demographic parameters that actually affect tourists' preferences for Kelantan vacation spots.

## Analysis for Factor Influencing Descriptive analysis of the factors affecting tourist visits among tourists in Kelantan, Malaysia.

**Table 2:** Descriptive analysis of the factors affecting tourist visits among tourists in Kelantan, Malaysia

<b>Variables (Experience)</b>	<b>N</b>	<b>Mean</b>	<b>Standard Deviation</b>
<b>I choose to relax and rest while travelling.</b>	<b>384</b>	<b>3.82</b>	<b>1.055</b>
<b>I choose the destination as a stress-relieving and physical,mental fatigue relieving goal.</b>	<b>384</b>	<b>3.91</b>	<b>1.062</b>
<b>I choose that destination because it can help me from spending over a limited budget</b>	<b>384</b>	<b>3.92</b>	<b>.987</b>
<b>I choose the destination as it is influenced by beautiful and cultural values.</b>	<b>384</b>	<b>3.78</b>	<b>1.058</b>
<b>I travel because the destination has beneficial from my mental health.</b>	<b>384</b>	<b>4.01</b>	<b>.927</b>
<b>I travel because I want to visit new place.</b>	<b>384</b>	<b>4.05</b>	<b>.926</b>
<b>I travel to get new knowledge about history,culture and unique that place</b>	<b>384</b>	<b>4.04</b>	<b>.904</b>
<b>I travel because i want to spend time with my family and my friends to keep in touch with them</b>	<b>384</b>	<b>3.93</b>	<b>1.039</b>
<b>I travel because I want to increase my communication skills and social skills.</b>	<b>384</b>	<b>3.91</b>	<b>.943</b>
<b>I travel because I want to make new friends and followers.</b>	<b>384</b>	<b>3.69</b>	<b>1.016</b>

<b>Variables (Destination Image)</b>	<b>N</b>	<b>Mean</b>	<b>Standard Deviation</b>
<b>The destination has good quality infrastructure.</b>	<b>384</b>	<b>3.93</b>	<b>.933</b>
<b>The place is a beautiful and natural destination.</b>	<b>384</b>	<b>3.84</b>	<b>1.086</b>
<b>Destination is safe.</b>	<b>384</b>	<b>4.13</b>	<b>.920</b>
<b>Destination have a good board for tourist information.</b>	<b>384</b>	<b>4.05</b>	<b>.926</b>
<b>Tourist enjoyable travel destinations.</b>	<b>384</b>	<b>4.22</b>	<b>.884</b>
<b>I believe Kelantan has a strong cultural heritage.</b>	<b>384</b>	<b>4.10</b>	<b>.871</b>
<b>I believe that kelantan has high-quality accommodations for visitors.</b>	<b>384</b>	<b>4.05</b>	<b>.894</b>
<b>Kelantan is a popular destination for adventure tourism.</b>	<b>384</b>	<b>4.00</b>	<b>0.948</b>
<b>Kelantan is known for its food and drink offerings.</b>	<b>384</b>	<b>4.03</b>	<b>.944</b>
<b>Kelantan is a good destination for family-friendly vacations.</b>	<b>384</b>	<b>4.03</b>	<b>.932</b>

<b>Variables (Word-of-Mouth)</b>	<b>N</b>	<b>Mean</b>	<b>Standard Deviation</b>
<b>I often consult other tourists' online travel reviews to help choose an attractive destination.</b>	<b>384</b>	<b>4.07</b>	<b>.941</b>
<b>I frequently gather information from tourists' online travel reviews before I travel to a certain destination</b>	<b>384</b>	<b>3.82</b>	<b>1.065</b>
<b>If I don't read tourists' online travel reviews when I travel to a destination, I worry about my decisions.</b>	<b>384</b>	<b>3.77</b>	<b>1.051</b>
<b>When I travel to a destination, tourists' online travel reviews make me confident in traveling to the destination</b>	<b>384</b>	<b>3.93</b>	<b>1.079</b>
<b>I often consult other tourists' online travel reviews to make sure I choose the right destination</b>	<b>384</b>	<b>3.98</b>	<b>.971</b>
<b>When I would travel to Kelantan, I would feel secure in following the suggestions made by the travelers or friends.</b>	<b>384</b>	<b>3.81</b>	<b>1.060</b>
<b>When I would travel to Kelantan, I would rely on the recommendations made by the travelers or friends.</b>	<b>384</b>	<b>3.84</b>	<b>1.054</b>
<b>The word of mouth from friends and family influenced me to go to Kelantan.</b>	<b>384</b>	<b>3.99</b>	<b>.980</b>
<b>Social media has influenced me to go to Kelantan.</b>	<b>384</b>	<b>3.98</b>	<b>1.090</b>



<b>Variables (Tourist Visitation)</b>	<b>N</b>	<b>Mean</b>	<b>Standard Deviation</b>
<b>I will recommend coming to Kelantan.</b>	<b>384</b>	<b>4.05</b>	<b>.850</b>
<b>I will come again to Kelantan.</b>	<b>384</b>	<b>3.98</b>	<b>.979</b>
<b>I am satisfied with the facilities provided in Kelantan</b>	<b>384</b>	<b>4.01</b>	<b>.942</b>
<b>Kelantan is on my budget travel list..</b>	<b>384</b>	<b>3.99</b>	<b>.923</b>
<b>Kelantanese people are friendly.</b>	<b>384</b>	<b>4.06</b>	<b>.933</b>
<b>I know Kelantan have a lot of mosques.</b>	<b>384</b>	<b>4.18</b>	<b>.907</b>
<b>I will invite others to visit Kelantan</b>	<b>384</b>	<b>3.69</b>	<b>1.134</b>

<b>Variables (Factor Influencing Tourist Visit Kelantan, Malaysia)</b>	<b>N</b>	<b>Mean</b>	<b>Standard Deviation</b>
<b>Experience</b>	<b>384</b>	<b>0.54</b>	<b>.737</b>
<b>Destination Image</b>	<b>384</b>	<b>0.55</b>	<b>.631</b>
<b>Word-of-Mouth</b>	<b>384</b>	<b>0.47</b>	<b>.671</b>
<b>Tourist Visitation</b>	<b>384</b>	<b>3.99</b>	<b>.673</b>

Table 2 shows the mean and standard deviation of dependent variable and independent variable in this study. The highest mean value in dependent variable was obtained by Question 6 with 4.18 (SD = .907) where the respondents agreed that they have preference to love Kelantan because have a lot of mosques. Meanwhile, Question 7 has the lowest mean value with 3.69 (SD = 1.134) which means the respondents have preference to visit Kelantan after invite others to visit Kelantan. Independent variable for experience had the highest mean value that belongs to Question 5 with 4.05 (SD = .926) which means that the respondents agreed to visit the new place. After that, the lowest mean value was obtained by Question 10 with (SD = 1.016) where the respondents agreed that they want to visit because they want to get new friends and followers. Question 5 had the highest mean value for the independent variable destination image factor, with 4.22 (SD = 0.884, indicating that respondents believe that tourists enjoy travel destinations. Question 2 has the lowest mean value of 3.84 (SD = 1.086) meaning that the respondents agreed that the place beautiful and natural destination will maketourist revisit to Kelantan. The highest mean value for independent variable word-of-mouth isQuestion 1 with 4.07 (SD = .941, meaning that respondents agree with the statement that theyoften get consult other tourists' online travel review to help their to choose an attractive destination. Question 3 has the lowest mean score of 3.77 (SD = 1.051, showing that If they don't read tourists' online travel reviews when they travel to a destination, they can make mistakes about their decisions. The highest independent variable for the factor influencing tourist visit Kelantan is destination image with mean 0.55 (SD=0.631) , secondly is experiencewith mean 0.54 (SD=0.737) and lastly is word-of-mouth with mean 0.47 (SD=671).Not but least is mean for dependent variable for tourist visitation is 3.99 (SD=0.673)

## Relationship between Experience, Destination Image and Word-Of-Mouth towards Factors Influencing Tourist Visits among Tourists in Kelantan, Malaysia.

**Table 3:** Pearson's Correlation between experience, destination image and word-of-mouth towards factors influencing tourist visits among tourists in Kelantan, Malaysia.

		<b>Factors Influencing tourists visits among Tourists in Kelantan, Malaysia</b>
<b>Experience</b>	<b>Pearson correlation</b>	<b>0.541</b>
	<b>Sig. (2-tailed)</b>	<b>.000</b>
	<b>N</b>	<b>384</b>
<b>Destination Image</b>	<b>Pearson correlation</b>	<b>0.551</b>
	<b>Sig. (2-tailed)</b>	<b>.000</b>
	<b>N</b>	<b>384</b>
<b>Word-of-Mouth</b>	<b>Pearson correlation</b>	<b>0.474</b>
	<b>Sig. (2-tailed)</b>	<b>.000</b>
	<b>N</b>	<b>384</b>

The result in Table 3 indicates that experience and factors influencing tourists visits among tourists in Kelantan .541 indicated moderately positive correlation. Next is destination image and factors influencing tourist visits among tourists showed .511 indicating moderately positive correlation. Followed by word-of-mouth and factors influencing tourist visits among tourists with 0.474 indicated the weakly positive correlation. Therefore, all the two variables positively correlated with factors influencing tourist visits among tourists and the relationship is significant ( $p < 0.05$ ) meanwhile one variable weakly positive correlated with factors influencing tourist visits among tourists and the relationship is significant ( $p < 0.05$ )

**H1: There is a significant relationship between experience and tourist visitation among tourists.**

These domestic prior tourists might think about making a second trip to enjoy attractions or activities that they missed on their first trip or to relive their previous trip. If the guests like the place, they might come three or even more times.

**H2: There is a significant relationship between destination image and tourist visitation among tourists.**

(Lawson and Baud Bovy, 1977) 'the expression of all objective knowledge, impressions, prejudice, ideas, and emotional feelings an individual or group may have about a given place' is how one may define a destination image

**H3: There is a significant relationship between destination image and tourist visitation among tourists.**

WOM because this factor has the potential to mediate and moderate and is an essential moderating variable in the tourism industry and a key promotional tool.

## **DISCUSSION AND RECOMMENDATION**

This discussion aims to address the research question and hypothesis put forth in the preceding chapter, which serves as the initial chapter in this report. The primary focus of this study has been to thoroughly investigate the various factors that can potentially impact tourist visitation to Kelantan. Drawing upon the study's findings, several recommendations have been formulated for future researchers or for ourselves as researchers to enhance future studies.

In this study, the researcher obtained a sample size of 384 from tourists who have visited Kelantan. The determination of this sample size was based on the Krejcie and Morgan table (1970), considering the total number of tourists who visited Kelantan in 2021, which was 1,921,000 individuals. The purpose of using sample size is ensures that research resources are use efficiently and ethically and it will be evaluated based on the quality of the resulting estimate. However, if this study is conducted in the future, the researcher may choose a smaller population size based on the suitability of the study to reduce the number of sample sizes to be examined.

Furthermore, the researcher should make appropriate adjustments or scheduling to obtain the predetermined sample size of 384 individuals based on the study population. This is because the time constraint faced by the researcher in recruiting respondents for this study has resulted in insufficient time to complete the report. Additionally, some of the visitors did not have time to respond to the questionnaire provided on the online platform, namely Google Form. Therefore, it is recommended that future studies, whether conducted by us or other researchers, allocate time effectively to avoid time constraints or insufficient time for other tasks.

The research that we are doing uses quantitative methods, which aim to produce the best research. However, if this study is conducted in the future, the researcher will likely use qualitative methods for the information search process. This is because this qualitative method is quite different from the method used by researchers now, which is quantitative. The purpose of using qualitative methods in future studies is that it is possible to obtain different information and results. With that, the researchers can also determine and learn the differences likely to be found in the study using the qualitative method. For example, using this quantitative method, the researcher will likely not get data from specific information. However, using qualitative methods makes it more likely to get accurate data as a result of the research that has been conducted.

## **CONCLUSION**

In conclusion, the purpose of this study was to identify the factors that can impact tourist visitation to Kelantan. Three independent variables, namely Destination Image, Experience, and Word-Of-Mouth, were selected to investigate their relationship with the dependent variable, which is the number of tourist visitation to Kelantan. A total of 384 respondents aged 18 years and above, who were tourists visiting Kelantan, were randomly selected to investigate the factors influencing their decision to visit the Kelantan.

## REFERENCES

- Akter, M., Sadekin, M. N., & Patwary, A. K. (2020). An Empirical Study on Students' Satisfaction from Mawlana Bhashani Science & Technology University, Bangladesh. *Review of Economics and Development Studies*, 6(2), 363-379.
- Al Mahmud, S. R. (2020). The effectiveness of Facebook advertisements on purchase intention of customers in Malaysia. *South Asian Journal of Social Sciences and Humanities*, 1(1), 97-104.
- Alom, S., Patwary, A. K., & Khan, M. M. H. (2019). Factors affecting the turnover intention of Bangladeshi migrants in the United Arab Emirates: An empirical study on the hotel industry. *International Journal of Innovation, Creativity and Change*, 8(3), 344-360.
- Fauzi, S. (2014, September Thursday). *KEBERSIHAN DAN KEINDAHAN, SATU PENYELESAIAN KE ARAH KOTA BHARU BANDAR RAYA*
- Fengmin, Z., Baijun, W., Jiangtao, B., Li, L., & Patwary, A. K. (2022). Investigating revisit intention of medical tourists in China through nutritional knowledge, perceived medical quality, and trust in the physiologist: A recommendation on health tourism policy measures. *Frontiers in Public Health*, 10, 893497.
- GHANEM, J. (2017, September). Conceptualizing "the Tourist": A critical review of UNWTO definition. [https://dugi-doc.udg.edu/bitstream/handle/10256/14825/GhanemJoey\\_Treball.pdf](https://dugi-doc.udg.edu/bitstream/handle/10256/14825/GhanemJoey_Treball.pdf)
- Hazbar, A. M. H., Alem Mohammed, A., & Karim, A. K. A. (2019). An Empirical Study of Factors Influencing hotel customers' online booking Intention. *مجلة العلوم التربوية و الدراسات الإنسانية*, (5), 1-17.
- Kaur, S. (2021, March). *SAMPLE SIZE DETERMINATION*. [https://www.dosm.gov.my/v1/index.php?r=column/pdfPrev&id=VUM0cDk\\_vYIJhN0ZKdStDZ3hTSVpzQT09](https://www.dosm.gov.my/v1/index.php?r=column/pdfPrev&id=VUM0cDk_vYIJhN0ZKdStDZ3hTSVpzQT09)
- Li, L., Ragavan, N. A., Patwary, A. K., & Baijun, W. (2022). Measuring patients' satisfaction toward health tourism in Malaysia through hospital environment, nutritional advice, and perceived value: A study on Chinese exchange students. *Frontiers in public health*, 10, 893439.
- Li, L., Wu, B., & Patwary, A. K. (2022). How marine tourism promote financial development in sustainable economy: new evidences from South Asia and implications to future tourism students. *Environmental Science and Pollution Research*, 29, 1155-1172.
- Li, L., Wu, B., & Patwary, A. K. (2022). The psychosocial factors affecting chinese Outbound Exchange and mobility students' academic performance during COVID-19. *Frontiers in psychology*, 13, 872516.
- Mark Ransley. (2012, May). *Sustainable Tourism Practices*.
- Mohaidin, Z., Wei, K. T., & Ali Murshid, M. (2017). Factors influencing the tourists' intention to select sustainable tourism destinations: a case study of Penang, Malaysia. *International Journal of Tourism Cities*, 3(4), 442-465. <https://doi.org/10.1108/ijtc-11-2016-0049>
- mStar. (2010, February Friday). *Kementerian Pelancongan Bidas Kelantan Abai Aspek Kebersihan*. Retrieved from <https://www.mstar.com.my/lokal/semasa/2010/02/19/kementerian-pelancongan-bidas-kelantan-abai-aspek-kebersihan>
- Nair, V., Chiun, L. M., & Singh, S. (2014). The International Tourists' Perspective on Malaysia's Economic Transformation Programme (ETP). *Procedia - Social and Behavioral Sciences*, 144, 433-445.

Norfadila Binti Syafran, A. M. (2023). *Top 25 Kelantan Attractions (2023)*.

Patwary, A. K., Roy, B., Hoque, R., & Khandakar, M. S. A. (2019). Process of developing a community based tourism and identifying its economic and social impacts: An Empirical study on Cox's Bazar, Bangladesh. *Pakistan Journal of Humanities and Social Sciences*, 7(1), 1-13.

PORTAL RASMI KERAJAAN NEGERI KELANTAN - LAMAN UTAMA. (2023,

*Prestasi Pelancongan Domestik Mengikut Negeri, 2020*. (2021, September 30).

Rahman, A., & Muktadir, M. G. (2021). SPSS: An Imperative Quantitative Data Analysis Tool for Social Science Research. *International Journal of Research and Innovation in Social Science*, 05(10), 300-302. [repository.griffith.edu.au/bitstream/handle/10072/51545/83704\\_1.pdf;sequence=1](https://repository.griffith.edu.au/bitstream/handle/10072/51545/83704_1.pdf;sequence=1)

Roth, W.-M., & Jornet, A. (2014). Towards a Theory of Experience. ([https://web.uvic.ca/~mroth/PREPRINTS/Experience\\_424b.pdf](https://web.uvic.ca/~mroth/PREPRINTS/Experience_424b.pdf))

*Sample Size*. (2012). Griffith Research Online. <https://research->

Sumethokula, P., Patwary, A. K., Srinuanpanc, B., Srinuanpand, C., Suwandee, P., Thammathikul, A., & Phanong, W. (2020). The potential of new tour repackaging for creative tourism among entrepreneurs in Nakhon Si Thammarat. *International Journal of Innovation, Creativity and Change*, 13(10), 1752-1771.

Wu, B., Liu, S., Wang, J., Tahir, S., & Patwary, A. K. (2021). Assessing the mechanism of energy efficiency and energy poverty alleviation based on environmental regulation policy measures. *Environmental Science and Pollution Research*, 28, 40858-40870.

Wu, B., Zhai, B., Mu, H., Peng, X., Wang, C., & Patwary, A. K. (2021). Evaluating an economic application of renewable generated hydrogen: A way forward for green economic performance and policy measures. *Environmental Science and Pollution Research*, 1-15.

YANG BERSIH DAN SEJAHTERA. Retrieved from [http://akusuffianfauzi.blogspot.com/2014/09/kebersihan-dan-keindahan-satu\\_11.html#](http://akusuffianfauzi.blogspot.com/2014/09/kebersihan-dan-keindahan-satu_11.html#)



# FACTOR INFLUENCING THE DEVELOPMENT IN KOTA BHARU, KELANTAN

*Nurul Izzati Syuhada Binti Abd Basir, Nurul Nabila Binti Azman, Nurul Nabila Binti Jamaluddin,  
Nurul Nadia Izzah Binti Shafie & Zaimatul Awang*

*Faculty of Hospitality, Tourism and Wellness, Universiti Malaysia Kelantan  
Corresponding email: zaimatul@umk.edu.my*

---

## ABSTRACT

Kota Bharu, Kelantan offers a unique blend of culture, traditions, history, and natural beauty which serves as a major attraction for tourists; hence, the purpose of this research is to examine the relationship of tourism development in Kota Bharu, Kelantan with 3 aspects which is food image, destination image and islamic value. This research used a quantitative method and random sampling technique to collect data and involved the distribution of a total of 384 respondents among local tourists in Kelantan and people who visit Kelantan through an online survey which is a questionnaire. Data from the questionnaire were analysed using Statistical Package for Social Science ( SPSS ) to generate the quantitative result. Based on the finding, food image, destination image and islamic value are proven to be positively correlated to the factor influencing the tourism development in Kota Bharu, Kelantan. This research offers knowledge that might help the tourism development in Kelantan grow exponentially.

**Keywords:** food image, islamic value, destination image, tourism development

---

## INTRODUCTION

The largest and the most important industry in the world nowadays is tourism. the industry has been acknowledged as one of the most significant service sectors in the world (Schumcher, 2007). many government goals might include tourism on the social, environment , and economic level. according to the World Tourism Organization (UNWTO, 2008), tourism also refer to leisure pursuits, theory and application, product commercial activities and tourist sites.

## SIGNIFICANCE OF THE STUDY

In this section will be explained the significance of the study for the development of tourism in Kota Bharu, kelantan. The important in this study is the influencing Kelantan's tourism development. This study will assist the travel and tourism industry from practical point because there will be many tourists from abroad and locals who visit Kelantan, especially for the economy of the state of Kelantan. This research work will find out the challenges of sustainable development tourism in

Kelantan. This research will also find out the suggestions and guidelines that will help the policy and strategy determine what is negative and positive in Kelantan.

### **Food image**

According to (Huang, 2009) to get better understand the benefit of food image in destination marketing, it was necessary to identify the basic dimensions and component of food images.

### **Destination image**

In the study, the destination image was split into the cognitive image of the emotional image, was defined as the overall impression of the tourist destination. The image of the destination may be thought of as a pull factor that influenced travels decisions to visit or keep away the location (Gartner, 1994).

### **Islamic value**

It stands for moral principles that are often regarded as having high standards. It also represents environment protection and respect for the local customs and beliefs. It stands for a fresh perspective on the world and society. In a time when consumerism is rampant and everything is accessible for use and abuse in the most selfish ways, it restores morals to the forefront of society.

## **LITERATURE REVIEW**

### **I. Tourism Development**

Tourism development is described as the creation and implementation of strategies, infrastructure upgrades or other efforts judged appropriate by the council with the intention of boosting a destination's appeal and attracting more tourists. Individual's well-being and host countries' incomes can both grow with tourism expansion (Ahn et al., 2002). The use for tourism development is frequently criticized. One of these criticisms is that "to anything which is not mass tourism" is commonly used to refer to alternative or sustainable kinds of travel (Harrison, 2015). In reality, alternative tourism is frequently criticized for being too small-scale, encouraging feigned participation rather than genuine engagement, and escalating local inequality (Goodwin, 2009). The development in Kelantan is getting more and more rapid with the development of various industries, including food, tourism, and Islamic value, which will further boost the development of the state of Kelantan. The development in Kota Bharu

has shown its development in terms of food image, with more and more restaurants, cafes, and opening kiosks, which will further increase the number of tourists coming to Kota Bharu (Pratt, 2018).

## **II. Food Image**

Food is essential when traveling, but the food of a destination can also be an attraction (Stone & Migacz, 2016). Food is the network between tourism and destinations, as delicious food is a useful aspect of destinations (Horng & Tsai, 2012) and plays an important role in promoting and regular destinations (Horng & Tsai, 2010). Tourism in Malaysia is developing, with more and more tourists visiting the country. Food image are the most important factors shaping a visitor's understanding and influencing choice of tourist destinations (Long, 2004). Food image is a main factor in the tourism development of Kota Bharu, Kelantan. According to (Huang, 2009) to more appropriate understand the use of food image in tourism development in Kota Bharu, the basic dimensions and components of food image should be identified. According to (Syahida & Zainal, 2014), Kelantan is known as the Cradle of Malay Culture and is famous for its unique cultural heritage, natural surroundings and the exclusive hospitality of the locals, including unique food, which has influenced the tourism development of Kota Bharu.

## **III. Destination Image**

The knowledge of an individual's or group's ideal, print, prejudice, imagination, and emotional thinking about a certain location is included in their destination image (Y. Li, Xu, Song, & He, 2020). In reality, the destination image is supposedly important and useful in the decision-making process of travelers (Bruwer, Pratt, Saliba, & Hirche, 2017). It is thought that the more pleasant an image is, the more likely it is that the location will be taken into account and ultimately chosen (Baloglu & McCleary, 1999). This presumption prompts study and calls for a concentrated effort to increase a destination's allure, cultivating and maintaining a positive reputation as a means of distinction from competing locations and therefore providing a possible competitive advantage (James, Durand & Dreves, 1976). To put it another way, Hanan & Aminudin (2012) claimed that the belief, thoughts, and writing of tourists and callers together can influence tourists' perceptions of a destination. The top tourist attractions in

Kelantan are Pantai Cahaya Bulan, Pantai Irama, Pasar Siti Khadijah, the Gelanggang Seni Cultural Center, Muzium Islam, and many more.

#### **IV. Islamic Value**

Islamic tourism refers to any activity, event, relaxation, or experience brought out within an environment where their teachings are in harmonious relationship with the purpose of having experienced one's own experience in Islamic life by implementing architectural and religious activities, design attractions, and Islamic history (Islamic Tourism Center, 2009). In Malaysia, tourism based on Islamic history and beliefs has existed since long periods of time, when Islam originally started to expand, and it has the opportunity to attract more tourists, whether they are Muslims or not (Hanim, 2016). Islamic values might be one of the factors in developments in Kota Bharu, Kelantan since it is known as "Kota Serambi Mekah" (Daud, 2002). According to Hashim et al. (2007), Muslim prayer times are only available on the Kelantan State homepage, and none of the other home pages provide information on halal regional food or Muslim instruction or customs for people who aren't Muslims. Fatima, Naeem, & Rasool (2016) in their study on the perception of individuals or local tourists with regard to religious tourism measured the safety and security dimension.

#### **Research Hypothesis**

The research's hypothesis is formed based on the study's variables, such as food image, destination image, and Islamic value, that affect tourism development in Kota Bharu, Kelantan. The following hypothesis was developed and was to be evaluated based on the study:

H1: There is a positive relationship between food image and tourism development in Kota Bharu, Kelantan.

H2: There is a positive relationship between destination image and tourism development in Kota Bharu, Kelantan.

H3: There is a positive relationship between Islamic value and tourism development in Kota Bharu, Kelantan.

## Research Framework

The dependent variables and independent variables of this study are shown in Figure 1. The elements that influence the development of tourism in Kota Bharu, Kelantan, are known as independent variables which are food image, destination image, and islamic value. However, the dependent variable is tourism development. This figure shows the relationship between food image, destination image, and islamic value, and tourism development.

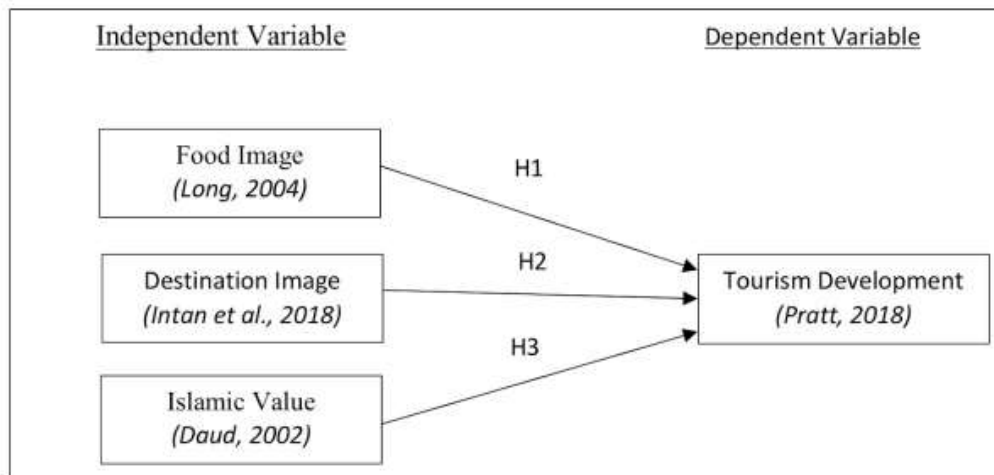

Figure 1: Conceptual framework

## **METHODOLOGY**

### **Research Design**

This study employed a quantitative research design using cross sectional survey. The design of quantitative analysis using figures and numbers to illustrate and adapt relationships among variables and their outcomes (Kumar, 2013). An online questionnaire that was distributed to the respondents was the tool used to obtain the data for the purpose of this study. This study used random sampling in order to gather and analyse participant data.

### **Data Collection**

The researcher was authorised to reach respondents using Google Forms in order to distribute the questionnaire effectively. The questionnaire is divided into three sections: Parts A, B, and C. Respondents must complete the first section of the survey by providing their demographic data. The independent variables - food images, destination images, and Islamic values in Kelantan are then discussed in the next section. The final section will inquire and assess the respondent's opinion of the dependent variable, which is the development of tourism in Kota Bharu, Kelantan. Particularly those who were in or had travelled to Kelantan were among the criteria used to choose the sample.

### **Sampling**

The major objective of the random sample is to identify the factors (Food images, Destination images and Islamic values) that travel reasons are most closely related to in Kota Bharu, Kelantan. Those who have visited Kelantan serve as the analysis's subject matter. A total of 384 respondents could be employed in this study due to the usage of an online questionnaire that was distributed to a large number of people.

### **Data Analysis**

Descriptive analysis, reliability, and correlation were the three methods of data analysis used in this study. Statistical Package for the Social Sciences (SPSS) was used to analyse the collected data. Finding out how frequently respondents select the same response is a procedure called descriptive analysis. Data from the analysis, including demographic information on the respondents, frequency distribution, etc., are all provided. The purpose of the reliability test is to make sure that the distributed questionnaire is capable of measuring the variables outlined in this study, namely food images, destination images, Islamic values, and the growth of tourism in Kota Bharu, Kelantan. It is measured

to ascertain the relevance and dependability of each item for each variable in the questionnaire. Meanwhile, correlation analysis is a statistical tool used in research to determine the relationship between two variables or data sets, as well as to investigate the strength of the relationship.

## FINDINGS

### Demographic Profile of Respondents

Table 2: Demographic Profile of Sample

<b>Characteristics</b>			%
Age	18-23 years old	170	44.3
	24-29 years old	138	35.9
	30-36 years old	52	13.5
	37-42	12	3.1
	43 years old	12	3.1
Gender	Male	118	30.7
	Female	266	69.3
Race	Malay	280	72.9
	Chinese	50	13.0
	Indian	37	9.6
	Others	17	4.4
Education Background	Secondary / Primary school	38	9.9
	Certificate / Diploma	98	25.5
	Bachelor Degree	243	63.3
	Master Degree / PHD	5	1.3
Employment Status	Self-employed	50	13.0
	Government Worker	33	8.6
	Private Sector Worker	54	14.1
	Student	244	63.5
	Retired	3	0.8

Table 2 presents an overview of the responder profile. The age group from 18 to 23 years old had the highest percentage of responders (44.3%), followed by the age group from 24 to 29 years old (35.9%),

the age group from 30 to 36 years old (13.5%), and the age group from 37 to 42 years and 43 years old (3.1%). Male respondents made up 118 of the total respondents, while female respondents made up 266. 384 people replied to the survey, including 280 Malay, 50 Chinese, 37 Indian, and 17 others. Malay respondents made up the majority of the sample (72.9%), followed by Chinese respondents (13.0%), Indian respondents (9.6%), and other respondents (4.4%).

The majority of respondents, at 63.3% (243 respondents), were students. 25.5% (98 respondents) of the respondents were certificate/diploma, 9.9% (38 respondents) was secondary/primary school and lastly. 1.3%(5 respondents) was master degree/PHD.

In addition, there were 244 respondents who was student. 13.0% (50 respondents) who was work as self-employed. 14.1% (54 respondents) as private sector worker. 8.6% (33 respondents) as government worker. Lastly, 0.8% (3 respondents) are retired.

### Reliability Test

A reliability system is employed to evaluate a system's overall performance and stability over a specific time period and in various testing scenarios.

Table 3: Results of Reliability Test

Variable	Number of items	Cronbach's Alpha coefficient	Strength of Association
Food Image	7	0.896	Very Good
Destination Image	7	0.843	Very Good
Islamic Value	7	0.908	Excellent
Tourism Development	7	0.909	Excellent

Table 3. showed the overall value of Cronbach's Alpha Coefficient for the independent and dependent variables in this study. From the table, we can conclude all the variables were above the value 0.6. therefore, the result shown was reliable and it can be accepted in this study.

There were seven question were used in measuring the food image variable that influenced tourism development in Kelantan. Table 4. showed that Cronbach's Alpha result for this section's requirement in food image variable was reliable.



Next, there had seven questions in measuring the destination image variable that influenced tourism development in Kelantan. The result Cronbach's Alpha coefficient that showed in this section is 0.843 which indicated very good. Thus, the coefficient obtained for the questions in the destination image variable were reliable.

Furthermore, in measuring the Islamic value variable that influenced tourism development in Kelantan, seven question were used. The Cronbach's Alpha result for this section's question was 0.908 which resulted in excellent. Therefore, the coefficient obtained for the questions in the Islamic value variable were reliable.

Lastly, in measuring the tourism development in Kelantan, seven question were used. The Cronbach's Alpha result for this section's question was 0.909 which resulted in excellent. Therefore, the coefficient obtained for the questions in the measuring the tourism development in Kelantan were also reliable.

### **Descriptive Analysis**

Descriptive analysis was conducted based on the data collected from the 384 respondents on section B, and C of questionnaire.

Table : 4 Descriptive Statistics

<b>Variable</b>	<b>N</b>	<b>Mean</b>	<b>Standard Deviation</b>
Food Image	384	4.2879	.60635
Destination Image	384	4.1183	.60682
Islamic Value	384	4.2835	.59167
Tourism Development	384	4.1637	.62844

Table 4 shows the mean and standard deviation analysis for the independent and dependent variables. The dependent variable was Tourism Development in Kota Bharu, Kelantan. Food Image, Destination Image, and Islamic Value were independent variables. Food Image had the highest mean score, 4.2879, indicating that respondents were more in agreement with this characteristic. The variable with the lowest mean value in this study's respondents' agreement was Destination Image, which has a value of just 4.1183. The data set that has more dispensing values has a standard deviation of more than 0 out of 384 respondents.

## Pearson Correlation

Pearson's correlation analysis was one of the most significant analyses that looked at the linear relationship between the two variables. This study's objective was to determine whether there were any correlations between the dependent variable which is Tourism Development in Kota Bharu, Kelantan and the independent variables which are Food Image, Destination Image, and Islamic Value. The researchers must decide what level of association strength is appropriate if the relationship is significant.

## Hypothesis 1

H<sub>1</sub>: There was a significant relationship between food image with tourism development in Kota Bharu, Kelantan.

Table 5: Correlation coefficient for Food Image and Tourism Development in Kota Bharu, Kelantan.

		Tourism Development	Food Image
Tourism Development	Pearson Correlation	1	.704**
	Sig. (2-tailed)		.000
	N	384	384
Food Image	Pearson Correlation	.704**	1
	Sig. (2-tailed)	.000	
	N	384	384

Table 5 showed the 384 examples, the significant value, and the Pearson correlation coefficient. The p-value was less than 0.01 and below the threshold of significance of 0.01. A strong positive association between a food image and tourism development may be seen in the correlation coefficient of 0.704.

## Hypothesis 2

H<sub>2</sub>: There was a significant relationship between destination image with tourism development in Kota Bharu, Kelantan.

Table 6: Correlation coefficient for Destination Image and Tourism Development in Kota Bharu, Kelantan.

		Tourism Development	Destination Image
Tourism Development	Pearson Correlation	1	.750**
	Sig. (2-tailed)		.000
	N	384	384
Destination Image	Pearson Correlation	.750**	1
	Sig. (2-tailed)	.000	
	N	384	384

Table 6 shows that there is a correlation between destination image and tourism development in Kota Bharu, with a correlation value of 0.750. This suggests that the relationship between destination image and tourism development is strong and significantly connected among tourists visiting Kota Bharu, Kelantan. Tourism development has a significant value of 0.000, which is less than a significant level

of 0.01. Hence, there is a significant relationship between tourism development and destination image. Hence, H2 is supported.

### Hypothesis 3

H<sub>3</sub>: There was a significant relationship between Islamic value with tourism development in Kota Bharu, Kelantan.

Table 7: Correlation coefficient for Islamic Value and Tourism Development in Kota Bharu, Kelantan.

		Tourism Development	Islamic Value
Tourism Development	Pearson Correlation	1	.736**
	Sig. (2-tailed)		.000
	N	384	384
Islamic Value	Pearson Correlation	.736**	1
	Sig. (2-tailed)	.000	
	N	384	384

Table 7 showed the 384 examples, the significant value, and the Pearson correlation coefficient. The p-value was less than the significant level of 0.01 at 0.01, or 0.01. Islamic Value and Tourism Development were strongly positively correlated, according to the correlation coefficient of 0.736.

Table 8: Summary of Correlation Analysis

Hypothesis	Significant Value	Conclusion	Correlation Value	Conclusion
1	0.000	Accepted	0.704	High Positive Correlation
2	0.000	Accepted	0.750	High Positive Correlation
3	0.000	Accepted	0.736	High Positive Correlation

To ascertain the linear relationship between the two variables listed as the study's goals, researchers performed correlation analysis. The findings of the correlation analysis are presented in Table 8, which showed a very strong correlation between the Food Image, Destination Image, Islamic Value and Tourism Development in Kota Bharu, Kelantan.

## DISCUSSION AND RECOMMENDATION

The purpose of the study was to ascertain the connection between Food Image, Destination Image, Islamic Value and Tourism development in Kota Bharu, Kelantan . The goal of this study is to understand the connection between Food Image, Destination Image, Islamic Value and Tourism development in Kota Bharu, Kelantan. Based on the findings of the study, there are some recommendations for tourism marketers as well as future researchers to improve the future study.

Kelantan has much to offer in terms of arts, culture and heritage tourism, ecotourism as well as cross border tourism. By providing a variety of 'Experiential Tourism' options, Kelantan may be able to entice a greater number of visitors, particularly those from other countries. The cultural traditions, legacy, and unique values that are practiced by the inhabitants of Kelantan are coupled with the natural riches of the region. To maintain the tourism at Kota Bharu Kelantan, the management of Kelantan's tourism industry must be aware of these features and behaviours.

Next, for future research. This research does make use of quantitative approaches for the goal of conducting better research. However, in the future, researchers may employ qualitative approaches to find information since qualitative methods take a different approach and can provide different information than quantitative methods. This is because qualitative methods use different methodologies. When compared to the methods that have come before, the results of the current study should be compared to those of the older studies to see whether there are any significant differences.

For instance, when researchers use a quantitative method, they might not acquire particular data, whereas when researchers use a qualitative method, they are more likely to receive correct data.

## CONCLUSION

This study examines the tourism development in Kota Bharu, Kelantan, especially Malaysians who have traveled to Kelantan. Based on the findings of the study, the independent variables of Food images, Destination images and Islamic values were found to influence the dependent variable which is the development of tourism in Kota Bharu, Kelantan with a positive correlation between the variables. Objectives and research questions have also been achieved and answered. Limitations such as technical, methodological and other related problems have been identified and some recommendations have been prepared to improve future research, such as by considering other variables and sampling methods. Overall, the researcher has successfully proven the efficiency of the study regarding the factors tourism development in Kota Bharu, Kelantan.

## REFERENCES

- Academy, E. (2022, November 6). *How to Develop a Good Research Hypothesis*. Enago Academy. <https://www.enago.com/academy/how-to-develop-a-good-research-hypothesis/>
- Akter, M., Sadekin, M. N., & Patwary, A. K. (2020). An Empirical Study on Students' Satisfaction from Mawlana Bhashani Science & Technology University, Bangladesh. *Review of Economics and Development Studies*, 6(2), 363-379.
- Al Mahmud, S. R. (2020). The effectiveness of Facebook advertisements on purchase intention of customers in Malaysia. *South Asian Journal of Social Sciences and Humanities*, 1(1), 97-104.
- Alam, A. S. A. F., Er, A. C., Begum, H., & Alam, M. M. (2015b). The Factors of Selecting Malaysia as Tourist Destination. *Mediterranean Journal of Social Sciences*. <https://doi.org/10.5901/mjss.2015.v6n3s1p491>
- All Answers Ltd. (2022, July 27). *Effect of Tourism on Asia's Economic Growth*. <https://ukdiss.com/examples/effect-of-tourism-on-asian-economic-growth.php>
- Alom, S., Patwary, A. K., & Khan, M. M. H. (2019). Factors affecting the turnover intention of Bangladeshi migrants in the United Arab Emirates: An empirical study on the hotel industry. *International Journal of Innovation, Creativity and Change*, 8(3), 344-360.
- Bhandari, P. (2022, December 5). *Population vs. Sample | Definitions, Differences & Examples*. Scribbr. <https://www.scribbr.com/methodology/population-vs-sample/>
- Bhandari, P. (2022, November 30). *Data Collection | Definition, Methods & Examples*. Scribbr. <https://www.scribbr.com/methodology/data-collection/>
- Bhat, A. (2022, December 26). *Data Collection Methods: Sources & Examples*. QuestionPro. <https://www.questionpro.com/blog/data-collection-methods/>

- Bhuiyan, M. A. H., Siwar, C., & Ismail, S. M. (2013). Tourism Development in Malaysia from the Perspective of Development Plans. *Asian Social Science*, 9(9). <https://doi.org/10.5539/ass.v9n9p11>
- Bouchrika, I. (2022, October 14). How to Write a Research Question: Types, Steps, and Examples. Research. <https://research.com/research/how-to-write-a-research-question>
- CEICdata.com. (2022, July 4). *Malaysia Domestic Tourism: Number of Visitors: Kelantan*. Economic Indicators | CEIC. <https://www.ceicdata.com/en/malaysia/domestic-tourism/domestic-tourism-number-of-visitors-kelantan>
- Chen, G., & Huang, S. (2018). *Understanding Chinese cultural tourists: Typology and profile*. *Journal of Travel & Tourism Marketing*, 35(2), 162-177.
- Dolezal, C., Trupp, A., & Leepreecha, P. (2020). Researching tourism and development in Southeast Asia. *Tourism and Development in Southeast Asia*, 41–56. <https://doi.org/10.4324/9780429264191-3>
- Fengmin, Z., Baijun, W., Jiangtao, B., Li, L., & Patwary, A. K. (2022). Investigating revisit intention of medical tourists in China through nutritional knowledge, perceived medical quality, and trust in the physiologist: A recommendation on health tourism policy measures. *Frontiers in Public Health*, 10, 893497.
- Hanan, H., & Abd Hamid, Z. (2017). *Tourist perception towards Kelantanese food image*. In *Journal of Tourism, Hospitality & Culinary Arts (Vol. 443, Issue 2)*.
- Hanan, H., & Aminuddin, N. (2012). *Food festival towards destination image of Kelantan*. *Melaka international heritage conference 2012 & 5th tourism outlook conference 2012 (pp. 88-93)*. Shah Alam: Penerbit UiTM.
- Hashim NH, Murphy J, Hashim NM (2007) *Islam and online imagery on Malaysian local tourist destination*. *Journal of Computer-Mediated Communication* 12, 1082-1102.
- Hazbar, A. M. H., Alem Mohammed, A., & Karim, A. K. A. (2019). An Empirical Study of Factors Influencing hotel customers' online booking Intention. *مجلة العلوم التربوية و الدراسات الإنسانية*, (5), 1-17. <https://www.hmetro.com.my/santai/2018/08/372135/destinasi-mesra-muslim>
- [https://www.researchgate.net/publication/320271168\\_Perception\\_of\\_Kelantan\\_Food\\_Image\\_among\\_Tourists\\_Visiting\\_Kelantan](https://www.researchgate.net/publication/320271168_Perception_of_Kelantan_Food_Image_among_Tourists_Visiting_Kelantan)
- Intan, S., Wong, N., & Lui, E. (2018). *Satisfaction Drivers and Revisit Intention of*. *Jurnal of Tourism, Hospitality and Environment Management*, 3(June), 1–13.
- Islam, M. H. (2019, March 16). *ISLAM AND CIVILIZATION (ANALYSIS STUDY ON THE HISTORY OF CIVILIZATION IN ISLAM)* | *Al-Insyiroh: Jurnal Studi Keislaman*. *Islam, Civilization, History*. <http://ejournal.kopertais4.or.id/madura/index.php/alinsyiroh/article/view/3395>
- Ithnin, H. (2018, August 28). *Muslim friendly destination*. *Daily Metro*, Retrieved from
- Jansen, D. (2022, December 6). *What Is Research Methodology? Definition + Examples*. Grad Coach. <https://gradcoach.com/what-is-research-methodology/>
- Li, L., Ragavan, N. A., Patwary, A. K., & Baijun, W. (2022). Measuring patients' satisfaction toward health tourism in Malaysia through hospital environment, nutritional advice, and perceived value: A study on Chinese exchange students. *Frontiers in public health*, 10, 893439.
- Li, L., Wu, B., & Patwary, A. K. (2022). How marine tourism promote financial development in sustainable economy: new evidences from South Asia and implications to future tourism students. *Environmental Science and Pollution Research*, 29, 1155-1172.
- Li, L., Wu, B., & Patwary, A. K. (2022). The psychosocial factors affecting chinese Outbound Exchange and mobility students' academic performance during COVID-19. *Frontiers in psychology*, 13, 872516.
- Liu, A., & Wall, G. (2006). Planning tourism employment: a developing country perspective. *Tourism Management*, 27(1), 159–170. <https://doi.org/10.1016/j.tourman.2004.08.004>

- M. (2020, October 20). *Kelantan*. ECERDC. <https://www.ecerdc.com.my/key-economic-clusters/tourism/creating-destinations/kelantan/>
- Maillard, J. Y. (2013). Editorial - What is the significance and impact of a study? *Letters in Applied Microbiology*, 57(1), 1–1. <https://doi.org/10.1111/lam.12093>
- McCombes, S. (2023, January 3). *What Is a Research Design | Types, Guide & Examples*. Scribbr. <https://www.scribbr.com/methodology/research-design/>
- Muhammad Na'im Daud (2002) *Pentadbiran agama Islam di Kelantan: Kajian di akhir abad ke- 19 sehingga awal abad ke-20 Masehi (PhD dissertation) Jabatan Pengajian Islam, Universiti Kebangsaan Malaysia*.
- Mukesh, K., Salim, A.T., & Ramayah, T. (2013). *Business research methods*. Kuala Lumpur: Oxford University Press
- NCBI - WWW Error Blocked Diagnostic. (n.d.). <https://www.ncbi.nlm.nih.gov/pmc/articles/PMC3105563/>
- OnlineVisa (2020). *Cultural Diversity Attracts Tourists to Visit Malaysia in 2020*. February 3, 2020. Retrieved October 29, 2020 from <https://www.onlinevisa.com/news/cultural-diversity-attracts-tourists-to-visit-malaysia-2020/>
- Patwary, A. K., Roy, B., Hoque, R., & Khandakar, M. S. A. (2019). Process of developing a community based tourism and identifying its economic and social impacts: An Empirical study on Cox's Bazar, Bangladesh. *Pakistan Journal of Humanities and Social Sciences*, 7(1), 1-13.
- Perception of Kelantan Food Image among Tourists Visiting Kelantan, 9(2), 443-452.
- Promsivapallop, P., & Kannaovakun, P. (2019). *Destination food image dimensions and their effects on food preference and consumption*. *Journal of Destination Marketing & Management*, 11, 89-100.
- Schumacher, H. J. (2007, June 15). Let's Talk Europe: Ecotourism. *Business World*. p. S1/6.
- Sumethokula, P., Patwary, A. K., Srinuanpanc, B., Srinuanpand, C., Suwandee, P., Thammathikul, A., & Phanong, W. (2020). The potential of new tour repackaging for creative tourism among entrepreneurs in Nakhon Si Thammarat. *International Journal of Innovation, Creativity and Change*, 13(10), 1752-1771.
- Tourism development Definition. (n.d.). Law Insider. <https://www.lawinsider.com/dictionary/tourism-development>
- Tourism Malaysia (2020). Visit Malaysia Year 2020: Visit Truly Asia Malaysia. Retrieved from November 27, 2020, from <https://www.tourism.gov.my/campaigns/view/visit-malaysia-year>
- Tripadvisor. (n.d.). *THE 15 BEST Things to Do in Kota Bharu - 2023 (with Photos)*. [https://www.tripadvisor.com/Attractions-g298285-Activities-oa0-Kota\\_Bharu\\_Kelantan.html](https://www.tripadvisor.com/Attractions-g298285-Activities-oa0-Kota_Bharu_Kelantan.html)
- UNWTO | World Tourism Organization a UN Specialized Agency. (n.d.). UNWTO. <https://www.unwto.org/>
- Wahab, R. A. (2022, October 4). *CONSUMERS' KNOWLEDGE, PERCEPTION OF FOOD IMAGE AND ACCEPTANCE TOWARDS FOOD HERITAGE IN KELANTAN | BIMP-EAGA Journal for Sustainable Tourism Development*. <https://jurcon.ums.edu.my/ojums/index.php/j-sustainable-tourism/article/view/3916>
- Walton, J. K. (2023, January 5). *Tourism | Definition, History, Types, Importance, & Industry*. Encyclopedia Britannica. <https://www.britannica.com/topic/tourism>
- Westcott, M. (2021, June 4). *1.1 What is Tourism? – Introduction to Tourism and Hospitality in BC – 2nd Edition*. Pressbooks. <https://opentextbc.ca/introtourism2e/chapter/what-is-tourism/>



- What is Tourism Development | IGI Global.* (n.d.). <https://www.igi-global.com/dictionary/the-engineering-of-territorial-tourism-study-case-of-algeria/49800>
- Wu, B., Liu, S., Wang, J., Tahir, S., & Patwary, A. K. (2021). Assessing the mechanism of energy efficiency and energy poverty alleviation based on environmental regulation policy measures. *Environmental Science and Pollution Research*, 28, 40858-40870.
- Wu, B., Zhai, B., Mu, H., Peng, X., Wang, C., & Patwary, A. K. (2021). Evaluating an economic application of renewable generated hydrogen: A way forward for green economic performance and policy measures. *Environmental Science and Pollution Research*, 1-15.
- [www.thingstodopost.org](http://www.thingstodopost.org). (n.d.). *Kota Bharu Food Guide: 10 Must-Eat Restaurants & Street Food Stalls in Kota Bharu*. Things to Do. <https://www.thingstodopost.org/kota-bharu-food-guide-10-must-eat-restaurants-street-food-stalls-in-kota-bharu-110122>

# **THE INFLUENCE OF SMART TOURISM APPLICATIONS ON PERCEIVED DESTINATIONS IMAGE IN KELANTAN**

*NURUL NAJIHAH BINTI RAMLI, NURUL NATASHA BINTI CHE WAN SARIF, NURUL NATASHA BINTI MOHD MALIKI, NURUL NATASYA BINTI MAT HASSAN & \*FAUZAN HAFIZ BIN MUHAMMAD SAFRI*

*Faculty of Hospitality, Tourism and Wellness, University Malaysia Kelantan  
hafiz.ms@umk.edu.my*

---

## **ABSTRACT**

The purpose of this research is to investigate the impact of smart tourism applications on perceived destination image in Kelantan. The purpose of this research was to investigate the relationship between smart information systems, smart sightseeing, smart ecommerce, and smart forecasting and perceived destination image. A questionnaire was used as the quantitative method. A total of 384 Gen Z tourists were chosen as respondents. The study's findings indicate a significant relationship between smart information systems, smart sightseeing, e-commerce, and smart forecasting, as well as the influence of smart tourism applications. Smart information systems and e-commerce systems are positively affected in information search, while smart sightseeing and smart forecasting are positively affected in e-recommendations.

**Keywords: Smart Tourism Application, Gen Z, and Destination Image.**

---

## INTRODUCTION

Tourism was defined as leisure, relaxation, entertainment, recreation, and hospitality (Morley,1990). According to Wild (2014), tourism is defined as a business enterprise that operates holidays and visits to famous and interesting destinations.

According to (Li, Hu, Huang, & Duan, 2017), Both the terms "smart tourism" and "smart destination" refer to a comprehensive tour information service provided to visitors while they are visiting a particular location using cutting-edge information and communication technologies (ICT). Many vacation spots have recently made an effort to accept this "smart" notion since it provides intelligent travel destinations with an advantage over competition over other tourist destinations based on the originality and distinctiveness of their product and service offerings.

According to the concept of intelligent tourism, this research was defined smart tourism application as a use of using technology in travel connected activities to improve visitors' tourism experiences in a certain places. Tourism or travel technology can improve travellers' experiences while also promoting tourism activities and interactions among tourism. Smart tourism has three major advantages which are economic, environmental, and socio-cultural. The economic advantages of smart tourism result from an injection of revenue into a destination's infrastructure. Smart tourist destinations typically include self-sufficiency systems, while the socio-cultural aspect refers to the indirect hedonic value created by smart or intelligent tourism initiatives.

There are four objectives in this research:

1. To study a smart information system application can improve how tourist perceive a destination image.
2. To identify the efficient e-commerce system apps can improve how tourists' perceived A destination image.
3. To study the useful smart sightseeing applications can improve how tourists' perceived A destination image
4. To study the efficient smart forecasting application can improve how tourists' perceived a destination image.

## **SIGNIFICANCE OF THE STUDY**

### **i. To the Academic Field**

It refers to the contribution and impact of research on a research field. The benefits of this study for future researchers, they can generate and develop more ideas and knowledge based on the issue. As information technology advances, the travel experience of future researchers improves, and their awareness or perception of their place image improves, which encourages their purpose to suggest that place or destination.

### **ii. Practical**

This research was carried out in order to learn more about Kelantan as a tourist destination in Malaysia. This discovery will provide a better understanding of Kelantan's history, famous places in Kelantan, and the culture of the Kelantan community. This research will also provide information to tourism agencies and the Kelantan government about the influence of smart tourism applications on the perception of Kelantan's destination image, as well as the extent to which they are influenced by smart tourism applications in Kelantan.

## **LITERATURE REVIEW**

### **Smart information system**

The words of "Smart Information Systems" refers to the interaction of cutting-edge technological tools and frameworks that combine Artificial Intelligence with Big Data to analyses, characterize, and predict information and the word of 'Smart Information Systems' also referring to the distribution of free Wireless Networking, barcode scanners and smartphone applications based on. In this case, the use of smart devices in the tourism sector is expanding, which maximizes the value of the industry's resources and generates significant social and economic benefits. Wearable and portable devices, such as smartphones, smart glasses, and smart watches, are examples of smart devices. Furthermore, the entire tourism industry makes use of smart devices, such as self-service kiosks for hotel check-in, flight check-in kiosks at airports, self-service ticket machines, and tour guide systems at tourist attractions. Tourists can receive services that are both convenient and effective by using these smart devices.

### **Smart sightseeing**

Using e-tour maps, e-guides, and recommendation services to promote a positive image of the destination is an example of smart sightseeing. So, considering tourists, intelligent sightseeing is important since it may help tourists in making their journey easier whether looking for a tourist attraction or shopping mall. One of the facilities that helps travellers is the availability of e-tourism maps, e-guides, and e-directions.

### **E-commerce system**

An e-commerce system is a piece of software that makes it possible to conduct business by buying and selling things online. In conclusion, customers need the ability to search for a particular product on an e-commerce platform, manage their shopping cart, and make payments. In the international travel and tourism sector, e-commerce systems are creating new business opportunities when the world opens with internet technology or online systems for the tourism industry. It helps in taking advantage of the potential market that e-commerce has created, travel-related organizations and internet businesses are collaborating.

### **Smart forecasting**

Intelligent forecasting platform (IFP) is a cutting-edge big data AI-based analytics platform designed to process unbounded time series data volumes with cutting-edge algorithmic capacity. It enables organizations to make data-driven strategic and operational decisions by automating prediction model lifecycle processes, while also streamlining planning and reducing uncertainty. Forecasting is critical because tourist flow and queueing time affect many tourists. Accurate time forecasting and arrangement encourages travellers to participation and visiting attractions in travel activities.

### **Perceived destination image**

Destination image consists of cognitive (belief and understanding about the location), efficiency (emotions toward a place), and cognitive constructs (visitors act according to cognitive and emotional elements). However, some places are unable to use smart destination positioning for smart tourism due to limitations in information digital, staff, time and money. It is difficult to replicate the concept of location as a wise choice in the latter scenario. As a result, both directly and indirectly, destination values may attract the process of co-creation with customers.

### **Relationship between independent variable and dependent variable.**

### **Relationship smart information systems and perceived destination image.**

The efficiency of Qr codes and Wi-Fi for smart information systems increases the perceived favourability of an intelligent place or destination. For tourists who are traveling and looking for information, having access to the internet is essential. In many public spaces including buses, lobbies of hotels, and neighbourhood stalls, visitors can use their smartphones to connect to free Wi-Fi. To make it simple for tourists to visit their website and get information, many tourism businesses offer a Qr code.

#### **Relationship smart sightseeing and perceived destination image.**

Tourists must be given accurate smart sightseeing information. Tourists may prepare for their trip experience by having complete and accurate information about e maps, and recommended e tours. It is advised to provide clear information that is simple to comprehend and use. Offering tourists choices might provide them time flexibility, such as e-travel guides that compare the time and expense of traveling to various locations. Destination information may improve resource efficiency, lessen traffic congestion and wait times for tourists, and encourage interaction between tourists and local communities. The degree of intelligence of the online information and the data sources used by travel agencies and destination management institutions s offer can have an impact on how much time tourists spend searching for information. According to li et al. In 2009, when it relates to smart sightseeing, visitors with low information search frequency have a more advantageous impact on the perceived destination image than visitors with high information search frequency

#### **Relationship e-commerce systems and perceived destination image.**

E-commerce systems could significantly improve people's perception of destination image. In giving visitors a smooth online experience, high-quality, secure e-commerce platforms can boost their confidence when making reservations and purchases online. Direct and open communication between tourism providers and customers can increase trust in online business transactions throughout the e-commerce experience. Furthermore, tourist data on online shopping can be useful for future data analysis, marketing, and strategic planning.

#### **Relationship smart forecasting and perceived destination image.**

In forecasting applications, anomaly detection methods are divided into two categories: model-based approaches and feature-based approaches. Forecasting applications and information are very useful to tourists. With smart forecasting, tourists can prepare for their trip experience by having complete and accurate information on tourist flow and queuing times. Offering options to tourists can help them save time and money when travelling from one location to another. Big data projects can aid in the provision of real-time visitor flow statistics and queueing time projections, as well as population and traffic management, crisis management, and policy formulation. Destination information can improve resource efficiency, reduce tourist traffic and wait times, and facilitate dialogue between locals and tourists.

## **RESEARCH HYPOTHESIS**

The research hypothesis was developed based on elements such as smart information systems, e-commerce systems, smart sightseeing and smart forecasting that affected the perceived destination. The following hypotheses (h1–4) are put out to fill the knowledge gap in the area of tourism activities and the design of the visitor experience:

1. H1. Effective use of smart information systems can influence how visitors view a place.
2. H2. An efficient smart sightseeing app can improve how travelers see a destination.
3. H3. A successful application for an e-commerce system can improve the perception of the destination among tourists.
4. H4. A successful smart forecasting application can improve how visitors perceive a destination.

## RESEARCH FRAMEWORK

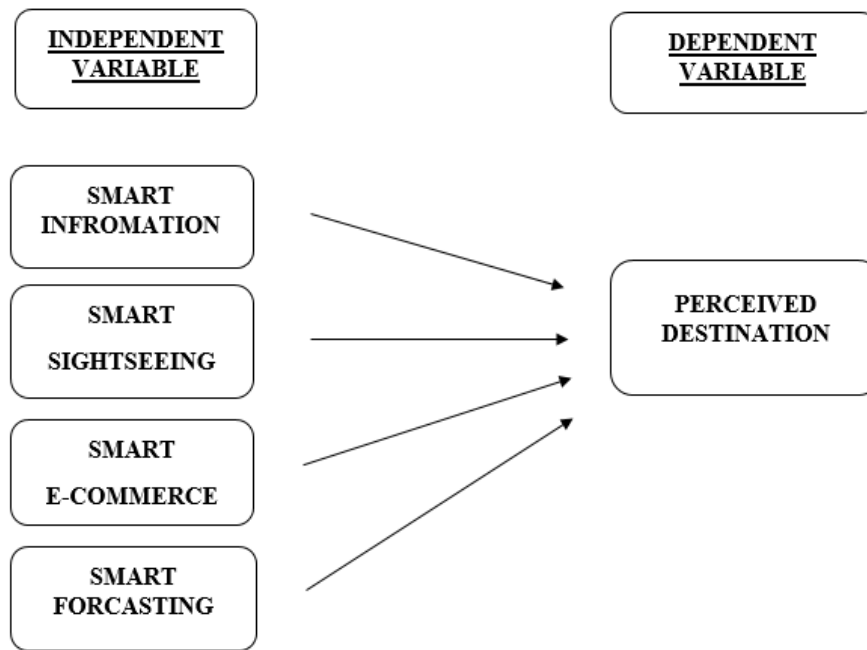

## METHODOLOGY

### Research design

A research design is essentially a plan for research that outlines the steps researchers should take to accomplish their goals or test their hypotheses proposed for their research. The value of research design lies in ensuring that the evidence generated from the data responds firmly and convincingly in response to the questioning. It can generally be separated into analysis of qualitative and quantitative frameworks.

### Data collection

The process of gathering data from diverse sources in order to identify answers to the research problems is known as the data collecting data. Additionally, the data collected will be used to test the hypothesis and assess the results. Primary data and secondary data are the two types of data that are commonly gathered to finish a research study. The researcher used Google Forms to distribute a questionnaire to gather data for this research study. This method will be used because questionnaires are typically less expensive because they are standardised, and they are also relatively error-free. It is also an efficient method of gathering data from a large number of respondents.

### Sampling

A sample represents a portion of the total population that perfectly represents it. The total number of samples chosen for the study is the sample size. The sample size is helpful in understanding a group



of participants chosen from the overall population who are thought to be a good representation of the study's target population. The target population will be used to select the sample for this study and help researchers to study it very well. Based on widespread agreement and new Gen Z analysis in the Pew Research Centre, the sample size is 384 Gen Z people born between 1997 and 2012.

### Data analysis

Research data analysis is a strategy study utilized to compress and adapt information into a story. It helps to make obvious that the data analysis method helps to break down a great quantity of information into smaller bits. Additionally, the objective of data analysis is to have a greater understanding of the information before making conclusions. The information gathered from respondents in this study was evaluated using the social sciences statistical package (SSSP). Statistical analysis software for batch and non-batch logic is known as spss statistics. To collect data, researchers also use frequency, descriptive statistics, reliability tests, pilot tests, and correlation tests.

### FINDINGS

#### Smart Information System (SIS)

Variable	Items	Mean	Std. Deviation	Ranks
SIS1	Through a wireless radio connection, Free Wi-Fi enables users to connect portable devices like personal digital assistants and mobile phones to the Internet. Currently, it is widely used in hotels, airports, and cafés.	4.54	.669	2
SIS2	Mobile devices can use quick response codes to acquire details about nearby attractions.	4.47	.681	1

The table above displays the highest mean score for the question about "Free Wi-Fi allows users to connect portable devices such as personal digital assistants and mobile phones to the Internet via a wireless radio connection." It is currently popular in hotels, airports, and cafés," with the second highest mean score of 4.54 and SD score of .669. The final question is about "Mobile devices can use quick response codes to obtain information about nearby attractions."

#### smart sightseeing

Variables	Items	Means	Std. Deviation	Ranks
-----------	-------	-------	----------------	-------

SS1	Users can create unique itineraries based on their own points of interest and collaborate to develop tour plans using the collaborative tour-planner technology.	4.48	.630	2
SS2	The logical step after guidebooks and audio cassettes is intelligent-guide technology. Tourists' experiences may be enhanced, and they may get new or different information.	4.46	.665	1
SS3	E-tourism-recommendation technologies could provide tourists with important information and help them locate and choose the websites that best match their interests.	4.52	.617	3
SS4	With the use of global positioning systems, electronic maps and compasses may provide tourists, hikers, and boaters with detailed geographic positions and directions.	4.52	.634	4

The question "The logical step after guidebooks and audio cassettes is intelligent-guide technology," as shown in table 4.10, had the highest mean score. Visitors' experiences could be enhanced, and they may learn something new or different. The mean score is 4.46, with a standard deviation of .665. The second question, with a mean of 4.48 and a standard deviation of 0.630, is about "Users can create unique itineraries based on their own points of interest and collaborate to develop tour plans using collaborative tour-planner technology." Third, "e-tourism recommendation technologies could provide tourists with critical information and assist them in locating and selecting websites that best match their interests." This question's mean and standard deviation were 4.52 and .617, respectively. The last question is, "With the use of global positioning systems, electronic maps and compasses may provide tourists, hikers, and boaters with precise geographic positions and directions," and the mean and standard deviation scores are 4.52 and .634, respectively. This leads to the conclusion that tourist pleasure can influence any decision.

#### **e-commerce system**

Variables	Items	Mean	Std. Deviation	Ranks
E-CS1	The market for buying travel-related items through mobile websites and applications is expanding. Mobile devices	4.53	.629	3

	are used by an increasing number of tourists to plan, pay for, and enhance their travels.			
E-CS2	In the travel industry, online coupons are being used increasingly often. People can get substantial savings with online coupons.	4.53	.629	2
E-CS3	Technologies like Wi-Fi, global positioning systems, geographic information systems, and global navigation satellite systems are deployed to meet the expectations of travelers making online bookings.	4.52	.630	1

According to the table above, the question "Technologies like Wi-Fi, global positioning systems, geographic information systems, and global navigation satellite systems are deployed to meet the expectations of tourists making online bookings" had the highest mean score, 4.52, and the SD score, .630. The following question is, "In the travel industry, online coupons are being used more frequently." People can save a lot of money by using online coupons." With a mean score of 4.53 and a standard deviation of .629. "The market for purchasing travel-related items through mobile websites and applications is expanding," says the final question. An increasing number of tourists use mobile devices to plan, pay for, and enhance their travels," received a mean score of 4.53 and an SD score of .629, the same as the second question. It can be seen here that many respondents travel using the E-commerce System method.

### smart forecasting

Variables	Items	Mean	Std. Deviation	Ranks
SF1	Using the routes followed and the movements of tourists, managers of tourist locations may forecast tourist flow and give early warnings.	4.51	.646	1
SF2	Tourist attractions can forecast and provide tourists a queueing time using smartphone applications.	4.49	.658	2

According to the table above, the question "Using the routes taken and the movements of tourists, managers of tourist destinations can forecast tourist flow and provide early warnings" had a

mean score of 4.51 and an SD of.646. The second question received a mean score of 4.49 and a standard deviation of.658 for "Tourist attractions can forecast and provide tourists with a queuing time using smartphone applications." This demonstrates that travellers' satisfaction with this application may increase their satisfaction with their trip to a location.

## **DISCUSSION AND RECOMMENDATION**

As for the discussion part, there are three different limitations in this study which are first, the study's limitations relate to the data collection and data analysis. The data obtained from the respondents take the researcher a lot of time to collect and analyse. The second limitation is there are several problems in the study when there is a lack of participation. When the majority of respondents do not cooperate with the researcher, data collecting has become difficult and takes time. The third limitation is that there are a few articles that can access previous research, making it difficult to find any good and relevant literature reviews. Due to payments or time limits, certain articles which ask for access might not be accessible.

Furthermore, as for the recommendation part, this study has various recommendations. This study only looks at the influence of smart tourism application on the image of the destination that is perceived in Kelantan. As a result, there are many tourists who should be the focus of future research. This study provides a number of recommendations for future research. While this study only focuses on the influence of smart tourism applications on the perceived image of the destination in Kelantan, there are many other factors that could be explored in future research. For instance, researchers could expand the sample size to improve the accuracy and reliability of the study. Additionally, it is recommended that open-ended questions be developed to eliminate misunderstandings and improve research findings, rather than relying solely on respondents' answers to scale online surveys. Given the widespread use of social media platforms like Instagram, Facebook, Twitter, and tiktok, future researchers could use these platforms to expand their findings and improve our understanding of the quality factors that impact tourist satisfaction in Kelantan.

## **CONCLUSION**

The goal of this study was to look into the impact of smart tourism applications on Kelantan's perceived destination image. In this study, the smart tourism application influenced the perceived destination image. In addition, four independent variables were present: smart information, smart sightseeing, smart ecommerce, and smart forecasting. The Pearson Correlation Coefficient was used to analyse these independent and dependent variables. This shows that the independent variable influences the dependent variable. Finally, the study's findings revealed a connection between smart

information, smart sightseeing, smart ecommerce, and smart forecasting and perceived destination image.

## REFERENCES

- Akter, M., Sadekin, M. N., & Patwary, A. K. (2020). An Empirical Study on Students' Satisfaction from Mawlana Bhashani Science & Technology University, Bangladesh. *Review of Economics and Development Studies*, 6(2), 363-379.
- Alom, S., Patwary, A. K., & Khan, M. M. H. (2019). Factors affecting the turnover intention of Bangladeshi migrants in the United Arab Emirates: An empirical study on the hotel industry. *International Journal of Innovation, Creativity and Change*, 8(3), 344-360.
- Buhalis, D., Amaranggana, A., 2015, Smart Tourism Destinations Enhancing Tourism Experience through Personalisation of Services, in Tussyadiah, I., and Inversini, A., (eds), ENTER 2015 Proceedings, Lugano, Springer-Verlag, Wien,
- Da Costa Liberato, P. M., Alen-Gonzalez, E., & De Azevedo Liberato, D. F. V. (2018). Digital technology in a smart tourist destination: The case of Porto. *Journal of Urban Technology*, 25(1), 75–97. <https://doi.org/10.1080/10630732.2017.1413228>.
- Dalgic, A., & Birdir, K. (2020). Smart hotels and technological applications. In E. Celtek (Ed.), *Handbook of research on smart technology application in the tourism industry* (pp. 323–343). Hershey, PA: IGI Global, Business Service Reference.
- Fengmin, Z., Baijun, W., Jiangtao, B., Li, L., & Patwary, A. K. (2022). Investigating revisit intention of medical tourists in China through nutritional knowledge, perceived medical quality, and trust in the physiologist: A recommendation on health tourism policy measures. *Frontiers in Public Health*, 10, 893497.
- Gretzel, U., Sigala, M., Xiang, Z., & Koo, C. (2015). Smart tourism: Foundations and developments. *Electronic Markets*, 25(3), 179–188. <https://doi.org/10.1007/s12525-015-0196-8>.
- Hazbar, A. M. H., Alem Mohammed, A., & Karim, A. K. A. (2019). An Empirical Study of Factors Influencing hotel customers' online booking Intention. *مجلة العلوم التربوية و الدراسات الإنسانية*, (5), 1-17.
- Hervé Panetto, Georg Weichhart, Marco Macchi, Qing-Shan Jia. Control for smart systems: Applications, trends, and future challenges. *Annual Reviews in Control*, 2022, 53, pp.356-357. [ff10.1016/j.arcontrol.2022.04.007](https://doi.org/10.1016/j.arcontrol.2022.04.007)ff. Ffhal-03641652f
- Li, L., Ragavan, N. A., Patwary, A. K., & Baijun, W. (2022). Measuring patients' satisfaction toward health tourism in Malaysia through hospital environment, nutritional advice, and perceived value: A study on Chinese exchange students. *Frontiers in public health*, 10, 893439.
- Li, L., Wu, B., & Patwary, A. K. (2022). How marine tourism promote financial development in sustainable economy: new evidences from South Asia and implications to future tourism students. *Environmental Science and Pollution Research*, 29, 1155-1172.
- Li, L., Wu, B., & Patwary, A. K. (2022). The psychosocial factors affecting chinese Outbound Exchange and mobility students' academic performance during COVID-19. *Frontiers in psychology*, 13, 872516.
- Michael Dimock (2019) Defining generations: Where Millennials end and Generation Z begins in Pew Research Center
- Patwary, A. K., Roy, B., Hoque, R., & Khandakar, M. S. A. (2019). Process of developing a community based tourism and identifying its economic and social impacts: An Empirical study on Cox's Bazar, Bangladesh. *Pakistan Journal of Humanities and Social Sciences*, 7(1), 1-13.

- Pimtong Tavitiyaman, Hailin Qu, Wing-sze Lancy Tsang & Chin-wah Rachel Lam (2021) Smart tourism application and destination image: mediating role of theory of mind (ToM), *Asia Pacific Journal of Tourism Research*, 26:8, 905-920, DOI: 10.1080/10941665.2021.1928252
- Pramtip Chompucum. (2018). The Challenge to Create Bangkok Smart Destination Image and Loyalty. *KKBS Journal of Business Administration and Accountancy*, 2(1), 43–53. <https://so04.tci-thaijo.org/index.php/kkbsjournal/article/view/161359>
- Russell, J.A. (1980) A Circumflex Model of Affect. *Journal of Personality and Social Psychology*, 39, 1161-1178. <http://dx.doi.org/10.1037/h0077714>
- Sumethokula, P., Patwary, A. K., Srinuanpanc, B., Srinuanpand, C., Suwandee, P., Thammathikulf, A., & Phanong, W. (2020). The potential of new tour repackaging for creative tourism among entrepreneurs in Nakhon Si Thammarat. *International Journal of Innovation, Creativity and Change*, 13(10), 1752-1771.
- Tavitiyaman, P., Qu, H., Tsang, W. L., & Lam, C. R. (2021). The influence of smart tourism applications on perceived destination image and behavioral intention: The moderating role of information search behavior. *Journal of Hospitality and Tourism Management*, 46, 476–487. <https://doi.org/10.1016/j.jhtm.2021.02.003>
- Wang, X., Li, X. (Robert), Zhen, F., & Zhang, J. (2016). How smart is your tourist attraction? Measuring tourist preferences of smart tourism attractions via a FCEM-AHP and IPA approach. *Tourism Management*, 54, 309–320. <https://doi.org/10.1016/j.tourman.2015.12.003>
- Wu, B., Liu, S., Wang, J., Tahir, S., & Patwary, A. K. (2021). Assessing the mechanism of energy efficiency and energy poverty alleviation based on environmental regulation policy measures. *Environmental Science and Pollution Research*, 28, 40858-40870.
- Wu, B., Zhai, B., Mu, H., Peng, X., Wang, C., & Patwary, A. K. (2021). Evaluating an economic application of renewable generated hydrogen: A way forward for green economic performance and policy measures. *Environmental Science and Pollution Research*, 1-15.

# Factors Affecting Gen Y Tourists' Purchase Intention Towards Local Food In Kelantan

*Nurul Sahira Binti Mohd Zan, Nurul Shahirah Binti Maiyurizal, Nurul Shazwanie Binti Mohd Zamin, Nurul Syairah Binti Subhi, \*Fauzan Hafiz Bin Muhamad Safri*

*Faculty of Hospitality, Tourism and Wellness, Universiti Malaysia Kelantan  
[hafiz.ms@umk.edu.my](mailto:hafiz.ms@umk.edu.my)*

---

## ABSTRACT

Malaysia's mixed race has created a variety of local food according to race and culture with reasonable prices, and make these places a suitable place for tourists especially in Kelantan. Kelantan is famous for its culture, heritage and nature. Gen Y is the first generation that does not require an authority figure to gain access to information, resulting in a distinct and advanced workforce. The research aim to analyse the relationship between food quality and purchase intention of Gen Y tourists' towards local food in Kelantan. A set of questions was employed to collect information in order to obtain all of the essential inputs to carry out this study and analysed with SPSS data analysis software. The four independent variables were found to be statistically significant and to have a positive linear relationship. Food quality, service quality, price, and restaurant environment all had a substantial impact on Gen Y tourists' purchase intentions.

**Keywords: Gen Y Tourists', Local Food, Purchase Intention**

---

## INTRODUCTION

Food and tourism have an inseparable relationship and the food is a significant source of tourism. (Henderson, 2004; Quan and Wang, 2004). It is important to supply energy to the body and when all travellers should eat when travelling, food may be the major draw and number one motivator for some people, which fulfils a variety of physiology and different desires (Tikkanen, 2007). Furthermore, food provides pleasure and entertainment for social purposes. This topic has attracted the attention of researchers who also consider one of the links between food manufacturing and marketing plans. Every traveller definitely needs a more relaxed and calmer attitude, but they have to decide what and where to eat outside of their home area. So, feeding and tasting national and authentic food is a great choice for a vacation.

Sometimes the experience of tourists hearing expressions in the community about products from various sources such as social media or websites also influence their purchase of the food. With that, the effect of local food knowledge needs to be studied so that its influence on customer purchase preferences can be seen. Buying the same product every day sometimes also makes users bored. According to Choe and Kim (2018), local food effortlessly draws the interests of tourists if it is prepared with widely recognised ingredients and methods and accompanied by explanations that are appropriate to their level of knowledge. Therefore, feedback and unique experiences need to be known to develop the intention to purchase local food.

Local food is recognized as an important factor in the selection of tourist destinations as well as a key component in tourist satisfaction and experience (Warshawsky and Vos, 2019). In this case, it should be known that the food industry in Malaysia has been faced with an increasing number of competitions. Although it is well-known among the local community itself, the variables that influence the intention to buy local food are still underexplored, especially in developing countries. A considerable amount of research refers to the conditions that contribute to the intention to buy local food, but consistent and interesting results have yet to be presented.

According to the Ministry of Tourism Malaysia (2013), Malaysia is home to various ethnic groups such as Malays, Chinese, Indians who each have their own unique and distinctive foods that

are marketed to tourists making Malaysia a unique destination. In Malaysia, food is an activity that contributes a lot in the tourism industry, especially local food. The number of tourists has increased significantly in spots where local and traditional meals have been pointed out through different food-related methods (Lai, Khoo-Lattimore and Wang, 2018). This is because the result of Malaysia's mixed race has created a variety of local food according to race and culture with reasonable prices, quality food and make these places a suitable place for tourists especially in Kelantan.

In fact, Kelantan is famous for its culture, heritage and nature. Although there is an increase in the number of tourist arrivals every year. However, there is very little data on the consumption of local Kelantan cuisine by tourists. So, this paper aims to examine the gap related to the intention to purchase local food in Kelantan. In other words, it will help explain some of the factors that influence the choice of that food.

The objectives of the specific study are formulated as below:

1. To analyses the relationship between food quality and purchase intention of Gen Y tourists' towards local food in Kelantan.
2. To examine the relationship between service quality and purchase intention of Gen Y tourists' towards local food in Kelantan.
3. To determine the relationship between price and purchase intention of Gen Y tourists' towards local food in Kelantan.
4. To investigate the relationship between restaurant environment and purchase intention of Gen Y tourists' towards local food in Kelantan.

## **Significance of the Study**

### **Tourists**

The research on the purchase intention towards local food in Kelantan is still limited. There is still minimal research and data on the cultural representation of Kelantan that is inclusive of both destination and food image.

### **Academic Researcher**

Academicians may use this study to explain the reliable factors for a better understanding of this subject.

### **Practical Researcher**

Researcher can be such a guidance for the awareness of the seller that might not realize that this topic kind of affects the performance of their sales. They might need this research to gain more knowledge on how to promote the local food of Kelantan to those who might want to try for the first time.



## **LITERATURE REVIEW**

### **Definition of Service Quality**

The term "actual result of the service" refers to the quantitative evaluation of the quality of the meals and beverages provided, including its quantity, presentation, freshness, flavour, and diversity. In this instance, it is only possible to assess the elements of the services after the product has been used. The measuring of tangible factors must also take into account the environment's physical cleanliness, safety and placement. Furthermore, the operation's working hours, environment, and physical location are all important. The lighting, temperature, music, and colours utilized in a restaurant can all have an impact on the overall atmosphere. As a consequence, it is important to consider the company's reputation in light of the fact that other visitors may form similar opinions about it and use it to decide whether to remain or go.

### **Food Quality**

According to Sulek and Hensley (2014), one of the most crucial elements of a dining experience is the cuisine's quality. The buyer's culinary quality objectives have a significant impact on the restaurants they select. Similarly, Susskind and Chan (2000) discovered that the quality of the meals is the primary driver of patronage in fast food outlets. Fast food restaurants believe that meal quality is an important aspect in determining client retention. Sulek and Hensley (2014) discovered that meal quality is the most important factor determining purchase intent when environmental aspects and service quality are compared to other restaurant-related parameters. Furthermore, the positive association between food quality and customer happiness will impact customers' purchasing intentions. Rajput (2002) further emphasized that important factors influencing meal quality in the food service industry include portion size, menu design and food presentation. Given that Muslims make up the majority of Malaysia's population, it is essential to think carefully about halal food consumption and hygiene.

### **Price**

Price is the most important component of purchase intention in the fast-food industry because most Malaysian customers pay great attention to a brand's pricing, which further stimulates them to purchase a meal. The cost of a comparable good is determined by a product's brand, raising the bar for brand manufacturing. Price has a strong influence on purchase intentions because production changes have a significant impact on customers. Furthermore, buyers are pleased with it and can afford it, which encourages them to purchase the brand's products again in the future (Gustafsson et al., 2005). As a result, the service provider should focus on brand costs that influence clients' purchasing intentions.

### **Restaurant Environment**

Customers are increasingly prepared to shell out more money for convenience services that enhance their eating experience. These elements motivate restaurateurs to concentrate their efforts on providing a more pleasant atmosphere for patrons. Numerous studies have shown the importance of enhancing the environment and introducing new concepts to guarantee a company's success.

It was also shown that customers regard a fast-food restaurant's environment more highly more than the instant foods itself. As a result of continuously regarded as higher than the food provided, the present study hypothesises that developing the environment of fast-food enterprises is their most crucial attribute. Prior to offering fast food, a restaurant's ambiance establishes what patrons anticipate from their eating experience. The quality of the food and services offered, especially in connection to the setting of a restaurant, strengthens the current study's intangible components even more.

Social signals, environmental cues and design cues are the three categories into which environmental cues are divided. More specifically, social signals are nearby individuals who are Ambient cues are the actual aspects of a room, while design cues are the aspects of a space that capture consumers' attention such as aroma and cleanliness. As two components of environmental signals, cleanliness and ambiance were the focus of the present investigation. This could be explained by the more frequent prioritization of environmental aspects by experienced consumers.

### **Factors Affecting Gen Y Tourists' Purchase Intention Towards Local Food in Kelantan**

Customers' assessments of production based on comparisons with goods from other companies in the same industry as well as their estimates of production services are both seen as indicators of customer satisfaction. In order to further investigating how consumers, feel about goods and services, purchase intention is in charge of determining if a product fits the demands and expectations of customers. According to this notion, customers would be pleased if the standards of the goods and services fulfilled their needs. Customers, on the other hand, won't be as happy if the manufacturing quality doesn't meet their standards. More crucially, since it keeps consumers and raises CLV (customer lifetime value), purchase intent is crucial for long-term company achievement.

It may be challenging to measure customer expectations and because businesses often learn about it is vital to maintain them once the product has been shifted in identifying purchase intention. Purchase intent is vital to businesses because it is a critical tool for maintaining a competitive advantage, despite the complexity and price involved. A high degree of purchase intent may also help you build fruitful connections with your customers.

### **Research Hypothesis**

Four hypothesis have been evaluated in this study, namely;

H1: Food quality has a positive influence toward purchase intention.

H2: Service quality has a positive influence toward purchase intention.

H3: Price has a positive influence on purchase intention.

H4: Restaurant environment has a positive influence on purchase intention.

## Research Framework

The study methodology outlined below was developed to investigate the link between independent factors (service quality, food quality, pricing, and restaurant environment) and dependent variables (buy intention). Furthermore, this approach may assess which aspects appear to be the most influential on visitors' gen Y attitudes about local food.

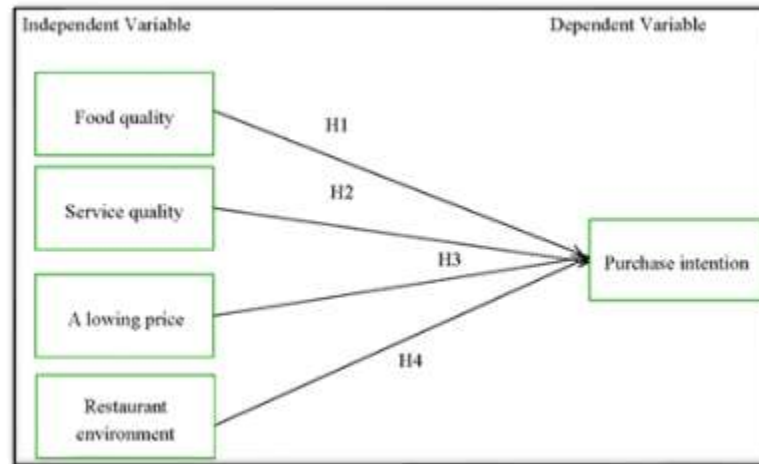

Figure 1: Factors Affecting Tourists' Gen Y Towards Local Food

Source: Adapted from: 'Factors Affecting Purchase Intention in Generation Y: An Empirical Evidence from Fast Food Industry in Malaysia'

(Shaohua Yang and Qaisar Iqbal, 2018)

## METHODOLOGY

### Research Design

This study employs a quantitative approach. Data for this study was gathered through exploratory research. The purpose of an exploratory research design is to conduct research on issues for which there is little or no prior research to consult (Shields & Rangarajan, 2013). The questionnaire was used as a data collection method in this study to capture responses about the purchase intentions of tourists of generation Y towards local food in Kelantan.

### Data Collection

The main data obtained is from the questionnaire. The questionnaire conducted consists of 255 respondents among young tourists who have travelled to Kelantan, where some of them are experienced about local food in the population areas visited. The researchers took about two weeks to gather data from the responses of those involved. The questionnaire answering session will be conducted through an online survey so that respondents can answer the questionnaire without taking a long time. In addition, the researcher also included some pictures of local foods to help respondents better understand the questions asked.

Meanwhile, the secondary sources were obtained from some of the articles. The purpose used to gather additional information in order to the decision-making process. The analysis also refers to related sources online which is newspaper online. This study was conducted by 25 questionnaires to

the respondents among the tourist's generation Y between 25-40 years old throughout an online survey to Kelantan.

### **Sampling**

The researchers utilized convenience sampling, a probability sampling technique, in this study. In order to gather research data for this study, quantitative sampling is used. In Kelantan, samples were gathered from a sizable generation Y of tourists who were interested in the local cuisine. Based on the Domestic Tourism Survey (2021), the data was collected of 97,900 tourists of generation Y who arrived in Kelantan. The information obtained serves to assist the researcher. So, the researcher's target is tourists among generation Y who have traveled to Kelantan to make this study a success. Furthermore, the local food of the Kelantanese community is also considered a tourism product in Malaysia. However, the amount of demand for purchasing local food among generation Y tourists has yet to be identified. There are even a few people who don't like or don't care about the existence of this local food. Therefore, the researcher lacks knowledge about the purchase of local food among generation Y tourists.

### **Data Analysis**

There were four data types of data analysis in this study, the researcher used the Statistical Package for the Social Sciences (SPSS). SPSS is a collection of software programmes packaged together in an individual package. The primary application of this programme is the study of empirical evidence in the social sciences. This data may be used for market research, surveys, and data processing. The researcher may rapidly comprehend the market demand for a product using the statistical information gathered, and the researcher can alter the plan accordingly.

Frequency analysis was used to forecast and quantify the predictability of particular values of some variable phenomena. Researchers systematically measure their observations by using frequency distributions or graphs. Before performing statistical analysis, researchers always organize data into organized categories. They actually do this through frequency distributions or charts to make it easy to read. A frequency distribution is a graphical or tabular graphic that shows the number of observations within a particular range of values. (Sundar Rao PS, Richard J., 2006). Measures of central tendency and location (mean, median, mode), measurements of dispersion, and measures of variance are four fundamental features of frequency distribution (range, variance, standard deviation), The degree of symmetry/asymmetry (skewness) as well as the flatness or peakiness (kurtosis). We might highlight this frequency distribution with the measures of central tendency and measures of dispersion.

In order to characterise and summarise data, descriptive statistics were utilised. This branch of statistics was enhanced by the availability of a vast quantity of data and extremely efficient computing tools. (Sarmiento, Rui & Costa, Vera, 2017). This analysis method will facilitate investigators to explain and formulate an observation supported based on what they need. In addition, this applied math technique is chosen by the researcher. As a result, it can help the researcher in establishing the principle related to the quantification. Applied math measure is the initial part of quantitative research, because it converts observations into numerical figures.

Reliability refers to the stability and internal consistency of a test or measurement tool in measuring a concept or aspect. It is related to the instrument's level of dependability, which is how dependable and consistent the instrument is.

If a researcher does the same test, the results will be the same. Or give the same answer at different times, the answer will be the same. Researchers must show instrument dependability because without it, research results obtained with the instrument are not repeatable, and replicability is

essential to the scientific method. The association of an item, scale, or instrument with a hypothetical one that genuinely measures what it is meant to is referred to as reliability.

Pearson's correlation is one of the correlation measures used to determine the energy and path of the linear dating among variables. Two variables are stated to be correlated while an alternate in a single variable is followed with the aid of using an alternate with inside the different variable, both with inside the equal path or with inside the contrary path. It has to be remembered that a small correlation coefficient cost (now no longer significant) does now no longer imply that the 2 variables aren't associated with every difference. It is feasible that variables have robust dating, however the cost of the correlation coefficient is near zero, as an example within the case of a non-linear dating.

## FINDINGS

**Table 1: Descriptive Analysis Result**

<b>Variables</b>	<b>N</b>	<b>Mean</b>	<b>Standard Deviation</b>
<b>Food Quality</b>	255	4.3098	0.80916
<b>Service Quality</b>	255	4.2225	0.74217
<b>Price</b>	255	4.2980	0.73669
<b>Restaurant Environment</b>	255	4.1647	0.72791
<b>Purchase Intention</b>	255	4.2327	0.78083

The number of respondents, mean ranking, and standard deviation of independent and dependent variables are shown in Table 1. For the independent variables, the highest mean is recorded for food quality at 4.3098 followed by price at 4.2980 also service quality at 4.2225 and restaurant environment at 4.1647. The mean for dependent variable is 4.2327.

**Table 2: Reliability analysis result**

<b>Reliability Test</b>	<b>N</b>	<b>Cronbach's coefficient</b>	<b>Alpha</b>	<b>Strength of Association</b>
<b>Total</b>	255	.952		<b>Excellent</b>

There were four independent variables and one dependent variable for this survey. This survey consists 15 questions for independent variables and 3 questions for dependent variables. The value of Cronbach's Alpha showed of all the independent variable and dependent variable of the reliability which was 0.952. It was shown that coefficient value of the variables ranges as excellent in term of reliability level.

**Table 3: Pearson Correlation.**

<b>Variables</b>		<b>R- Value</b>		<b>Level</b>
<b>Food Quality</b>	Pearson Correlation	0.675	1	Moderate
<b>Service Quality</b>	Pearson Correlation	0.685	1	Moderate
<b>Price</b>	Pearson Correlation	0.700	1	Moderate
<b>Restaurant Environment</b>	Pearson Correlation	0.691	1	Moderate

The intent of this study was to see if there were any relationships between the independent factors (food quality, service quality, price, and restaurant environment) and the dependent variable (purchase intention). As shown in Table 3, the Pearson correlation coefficient, significant value, and number of cases employed in this study were all 255. The R- value of food quality is 0.675 while service quality is 0.685. Also, price's R-value is 0.700 and restaurant environment is 0.691. The level of all variables is moderate.

## **DISCUSSION AND RECOMMENDATION**

This study's findings indicate that there is a significant association between food quality and purchase intention Gen Y tourists' toward local food in Kelantan. From the findings, correlation coefficient as much as 0.675 it shows that food quality is positive and moderate related to purchase intention Gen Y tourists' toward local food in Kelantan. The p value of food quality is 0.000 which is less than the highly significant level 0.0001. According to Sulek and Hensley (2014), discovered that meal quality is the most important factor determining purchase intention when environmental aspects and service quality are compared to other restaurant-related parameters.

Secondly, there is a positive association between service quality and purchase intention Gen Y tourists' toward local food in Kelantan. From the findings, correlation coefficient as much as 0.685 it shows that service quality is positive and moderate related to purchase intention Gen Y tourists' toward local food in Kelantan. The p value of service quality is 0.000 which is less than the highly significant level 0.0001. This finding was validated by (Zeithaml, 1998), service quality is commonly described as the overall superiority of the quality service on the impressions of tourists because the communication between service providers and clients directly affects the quality of the service.

This study also wants to determine the relationship between price and purchase intentions of Gen Y tourists' towards local food in Kelantan and it shown that there is a positive relationship between price and purchase intention Gen Y tourists' toward local food in Kelantan. From the findings, correlation coefficient as much as 0.700 it shows that price is positive and moderate related to purchase intention Gen Y tourist' toward local food in Kelantan. The p value of price is 0.000 which is less than the highly significant level 0.0001. According to Kotler and Armstrong (2009), claim that a tourist's impression of the price of any good or service can affect their decision to buy it because the value that tourists believe they will receive from a good or service is significantly influenced by the cost.

This finding also indicates there is a positive relationship between restaurant environment and purchase intention Gen Y tourists' toward local food in Kelantan. The correlation coefficient as much as 0.691 it shows that price is positive and moderate related to purchase intention Gen Y tourists' toward local food in Kelantan. The p value of price is 0.000 which is less than the highly significant level 0.0001. This finding was validate by (Ryu and Jang 2008), the setting of a high-end restaurant, restaurant environments are a substantial antecedent of tourists' pleasure, arousal, and desire to make a purchase because the environment of high-end restaurants frequently produces an opulent and refined ambience.

As in every research, this study also has its own limitations. The first limitation of the study is the small sample size used for surveying respondents' visitation to food images. Due to constraints in time and resources, only 255 questionnaires were distributed, which is considered insufficient for a comprehensive study.

Future researchers are recommended to expanding the sample size to include the entire Generation Y population in Kelantan in order to provide a more representative dataset. The terms of the questionnaire also can be improved by doing the screening question to make sure the data collected are more accurate and can be used.

## **CONCLUSION**

According to the research's findings, food quality, service quality, price, and restaurant environment all had a substantial impact on Gen Y tourists' purchase intentions. A favourable opinion of food and service quality enhanced the likelihood of purchasing food that was produced locally. Furthermore, the price and perceived value for money were important factors in defining their purchase intention. Furthermore, an attractive and appealing restaurant setting influenced their willingness to purchase local food.

These findings provide useful insights for Kelantan's local food businesses as well as marketers in understanding the aspects that influence Gen Y tourists' purchasing intentions. Improving food quality, raising service standards, maintaining competitive pricing, and providing a pleasant dining atmosphere are all practical consequences for attracting and retaining Gen Y customers.

## REFERENCES

- Akter, M., Sadekin, M. N., & Patwary, A. K. (2020). An Empirical Study on Students' Satisfaction from Mawlana Bhashani Science & Technology University, Bangladesh. *Review of Economics and Development Studies*, 6(2), 363-379.
- Alicia Tuovila. (2007, June 26). *Sampling: What it is, different types, and how auditors and marketers use it*. Investopedia. <https://www.investopedia.com/terms/s/sampling.asp>
- Alom, S., Patwary, A. K., & Khan, M. M. H. (2019). Factors affecting the turnover intention of Bangladeshi migrants in the United Arab Emirates: An empirical study on the hotel industry. *International Journal of Innovation, Creativity and Change*, 8(3), 344-360.
- Asghar Afshar Jahanshahi, Mohammad Ali and Khaled Nawaser. (2011). Study the Effect of customer service and product quality on customer satisfaction and loyalty. *Paripex Indian Journal of Research*, 3(8), pp.191-194
- Babbie, E. R. (2013). *The basics of social research*: Cengage Learning.
- Dan Fleetwood. (2022, October 4). *Types of sampling: Sampling methods with examples*. QuestionPro. <https://www.questionpro.com/blog/types-of-sampling-for-social-research>
- Dr. Lonny. (2020, March 11). *What is the importance of sampling in research? - My dissertation coach*. My Dissertation Coach. <https://mydissertation.coach/q-and-a/what-is-the-importance-of-sampling-in-research>
- Feenstra, G. W. (2009). Local food systems and sustainable communities. *American Journal of Alternative Agriculture*, 28-36.
- Fengmin, Z., Baijun, W., Jiangtao, B., Li, L., & Patwary, A. K. (2022). Investigating revisit intention of medical tourists in China through nutritional knowledge, perceived medical quality, and trust in the physiologist: A recommendation on health tourism policy measures. *Frontiers in Public Health*, 10, 893497.
- Gogtay, N. J., & Thatte, U. M. (2017). Principles of correlation analysis. *Journal of the Association of Physicians of India*, 65(3): 78-81.
- Hanan, H. & Hamid, Z.A. (2017). Tourist perception towards Kelantanese food image. *Journal of Tourism, Hospitality & Culinary Arts*, 9(2): 443-452.
- Hand, M. (2018). What is Local Food? *U.S. DEPARTMENT OF AGRICULTURE*.
- Hazbar, A. M. H., Alem Mohammed, A., & Karim, A. K. A. (2019). An Empirical Study of Factors Influencing hotel customers' online booking Intention. *مجلة العلوم التربوية و الدراسات الإنسانية*, (5), 1-17.
- Hulin, C., Netemeyer, R., & Cudeck, R. (2001). Can a Reliability Coefficient Be Too High? *Journal of Consumer Psychology*, 10, 55-58.
- Iqbal, Qaisar, and Siti Hasnah Binti Hassan. (2016). Service Quality about Health Sector of UK and Pakistan: A Comparative Study. *International Journal of Management, Accounting and Economics* 3: 473-85.
- Iqbal, Qaisar, and Siti Hasnah Hassan. (2018). A Dyadic Analysis of Salespersons and Customers in the Banking Sector: Humor Usage, Word of Mouth and Expectation of Continuity. *International Academic Journal of Business Management* 5: 109-120.
- Iqbal, Qaisar, Basheer Ahmad, and Adeel Nasim. (2016). A Gender Based Approach: Service Quality and Customer's Loyalty. *International Journal of Management, Accounting and Economics* 3: 822-36.
- Li, L., Ragavan, N. A., Patwary, A. K., & Baijun, W. (2022). Measuring patients' satisfaction toward health tourism in Malaysia through hospital environment, nutritional advice, and perceived value: A study on Chinese exchange students. *Frontiers in public health*, 10, 893439.



- Li, L., Wu, B., & Patwary, A. K. (2022). How marine tourism promote financial development in sustainable economy: new evidences from South Asia and implications to future tourism students. *Environmental Science and Pollution Research*, 29, 1155-1172.
- Li, L., Wu, B., & Patwary, A. K. (2022). The psychosocial factors affecting chinese Outbound Exchange and mobility students' academic performance during COVID-19. *Frontiers in psychology*, 13, 872516.
- Ma, Yaxin, and Shaohua Yang. (2018). An Empirical Study of Female E-shopper's Satisfaction with Cosmetic Products in China. *International Journal of Business and Management* 13: 211.
- Martinez Garcia, Jose Antonio, and Laura Martinez Caro. (2010). Rethinking perceived service quality: An alternative to hierarchical and multidimensional models. *Total Quality Management* 21: 93–118.
- McCombes, S. (2022, December 1). *Sampling Methods | Types, Techniques & Examples*. Scribbr. <https://www.scribbr.com/methodology/sampling-methods/>
- Nunally, J. C., & Bernstein, I. (1978). Psychometric Theory, ed. *New York McGraw*. Saunders et al 2009, *Sampling - Chapter 7 Whatever Your Research Question (S) and Objectives You*.
- Oosterbaan, R.J. (1988). *Frequency predictions and their binomial confidence limits*. In: *Economic Aspects of flood control and non-structural measures, Proceedings of the Special Technical Session of the International Commission on Irrigation and Drainage (ICID)*, Dubrovnik, pp. 149-160.
- Patwary, A. K., Roy, B., Hoque, R., & Khandakar, M. S. A. (2019). Process of developing a community based tourism and identifying its economic and social impacts: An Empirical study on Cox's Bazar, Bangladesh. *Pakistan Journal of Humanities and Social Sciences*, 7(1), 1-13.
- Pellinen, J. (2003). *Making price decisions in tourism enterprises*. *International Journal of Hospitality Management*, 22(2), 217–235.
- Raajpoot, Nusser A. (2002). A Multiple Item Scale for Measuring Tangible Quality in the Foodservice Industry. *Journal of Foodservice Business Research* 5: 109–27.
- Ryu, K., & (Shawn) Jang, S. (2008). *DINESCAPE: A Scale for Customers' Perception of Dining Environments*. *Journal of Foodservice Business Research*, 11(1), 2–22.
- Ryu, K., & Jang, S. (Shawn). (2006). *Intention to Experience Local Cuisine in a Travel Destination: The Modified Theory of Reasoned Action*. *Journal of Hospitality & Tourism Research*, 30(4), 507–516.
- Sarmiento, R., & Costa, V. (2017). Descriptive analysis. *Comparative Approaches to Using R and Python for Statistical Data Analysis*, 83–113. <https://doi.org/10.4018/978-1-68318-016-6.ch004>
- Schiffman et al. (2012). *African Journal of Hospitality, Tourism and Leisure*, 4 (2), 4-17.
- Shields, P. M., & Rangarajan, N. (2013). *A playbook for research methods: Integrating conceptual frameworks and project management*: New Forums Press.
- Sulek, Joanne M., and Rhonda L. Hensley. (2014). The Relative Importance of Food, Atmosphere, and Fairness of Wait: The Case of a Full-Service Restaurant. *Cornell Hotel and Restaurant Administration Quarterly* 45: 235–47.
- Sumethokula, P., Patwary, A. K., Srinuanpanc, B., Srinuanpand, C., Suwandee, P., Thammathikul, A., & Phanong, W. (2020). The potential of new tour repackaging for creative tourism among

entrepreneurs in Nakhon Si Thammarat. *International Journal of Innovation, Creativity and Change*, 13(10), 1752-1771.

Sundar Rao PS, Richard J. 4th ed. New Delhi: Prentice Hall of India Pvt Ltd; (2006). *Introduction to biostatistics and research methods*.

Susskind, Alex M., and Edwin K. Chan. (2000). How Restaurant Features Affect Check Averages: A Study of the Toronto Restaurant Market. *Cornell Hotel and Restaurant Administration Quarterly* 41: 56–63.

Uzunboylu, N. (2015). *Service Quality in International Conference Industry; A Case Study of WCES 2015*.

Wu, B., Liu, S., Wang, J., Tahir, S., & Patwary, A. K. (2021). Assessing the mechanism of energy efficiency and energy poverty alleviation based on environmental regulation policy measures. *Environmental Science and Pollution Research*, 28, 40858-40870.

Wu, B., Zhai, B., Mu, H., Peng, X., Wang, C., & Patwary, A. K. (2021). Evaluating an economic application of renewable generated hydrogen: A way forward for green economic performance and policy measures. *Environmental Science and Pollution Research*, 1-15.

# FACTORS THAT INFLUENCE TOURISTS' INTENTION TO CONSUME LOCAL FOOD IN KELANTAN

Nurul Syazwani Ahmad Nizal, Nurul Zafirah Firzah Buang, Nurul Huda Jamil, Nurzalina Zali & \*Fauzan Hafiz Muhammad Safri

*Faculty of Hospitality, Tourism and Wellness, Universiti Malaysia Kelantan  
Corresponding email: hafiz.ms@umk.edu.my*

---

## ABSTRACT

*Food tourism can encourage individuals to consume the food since food can easily be found whenever the person visits the places. This study aims to determine the factors that influence tourists' intention to consume local food in Kelantan. This research used quantitative surveys with convenient sampling. The data was collected through an online survey. This study employed a quantitative method with convenient sampling, and data was gathered from 321 tourists travelling to Kelantan via online survey using social media platforms such as WhatsApp. Results indicated that physical surroundings, excitement, prestige and escape from routine have a positive influence with intention to consume local food. These findings can help destination marketers and local restaurants strengthen the attractiveness of their locations and restaurants as well as the food celebration and events may encourage tourists to discover and participate in the regional food.*

**Keywords:** Local Food, Food Tourism, Physical Surrounding, Excitement, Prestige, Escape from Routine

---

## INTRODUCTION

The tourism industry includes people or individuals who spend more than a year traveling and residing in locations other than their usual surroundings for leisure, recreation, business, and other purposes. According to the world data on tourism, in terms of overall visitors, Malaysia welcomed four million tourists in 2020, placing it in 40th place globally. The number recorded in 2020 proves that the number of tourists to Malaysia has shown an increment from the previous year. This is due to several elements in tourism that have influenced the tourists to visit the country such as the attractions, leisure, accommodations, accessibility, amenities, and consuming food and beverage. From Malaysia's standpoint, the nation reported RM9.3 billion in net expenditures for the country's foreign tourists' food consumption in 2011 (Statista, 2016).

Every tourist destination must have a good attraction element to show that the place has its uniqueness and special features for tourists or visitors to come and experience the good attractions there. The element of food also belongs to the unique aspect of a destination. According to a survey, during a holiday, dining out accounted for more than one-third of all tourist expenditure, making food and drinks one of the crucial considerations for tourists who are on vacation or even on a business trip (Telfer & Wall, 2000).

The attractiveness of unique cuisine in a location greatly attracts tourists or visitors to come to that location, which is known as food tourism. In 2021, domestic tourists spent 2.8 billion Ringgit Malaysia (RM) on food and beverages, demonstrating the critical significance of food's roles in the tourism industry. From this total expenditure, it can be concluded that the diversity of food has great potential to influence tourism which will attract the attention of tourists or visitors to taste the difference of foods from each destination. Food tourism can encourage individuals to consume the food since food can easily be found whenever the person visits the places, especially when traveling to an area that they have never visited before to taste the local cuisine.

This study's aim is to see how the factors influence the tourist's intention to consume the local food in Kelantan. The deliciousness of the food, the quality of the ingredients used, the food's texture and colour that is interesting, and the portion and the way of food are given lead visitors or tourists to desire to try the food in the location. For example, Kelantan has the most popular local food, one of which is *nasi kerabu* where the rice is blue and various side dishes are served together that make people want to try it.

There are four objectives of this research :

1. To determine the relationship between physical surroundings and the intention of tourists to consume the local food in Kelantan.
2. To determine the relationship between excitement and the intention of tourists to consume the local food in Kelantan.
3. To determine the relationship between prestige and the intention of tourists to consume the local food in Kelantan.
4. To determine the relationship between prestige and the intention of tourists to consume the local food in Kelantan.

## **SIGNIFICANCE OF THE STUDY**

### **Practical Perspective**

It can assist food dealers worldwide, particularly in Kelantan, where they may use all the knowledge and information gained to put what they have learned into practice. By using this study as a roadmap to strengthen all of their weaknesses, the food industry can become even better at what they do.

### **Academic Perspective**

Academic research is essential to academic life. It is what teaches pupils how to develop their analytical and critical thinking abilities. They can develop a firm understanding of the area of study they chose via this process as well. Students have the potential to significantly advance their fields of study, depending on the caliber of the research they do. Because it enables students to learn more about the goals and conclusions of the research that are connected to knowledge. The researchers' arguments presented in the academic article give the reader access to the scholar's thoughts. Research enables understanding particular difficulties from various perspectives that were never identified or discussed in great detail.

## **LITERATURE REVIEW**

### **Physical Surroundings**

The physical environment is recognized to have a good impact. It demonstrates that a recovery effect has been linked to the improvement in psychological well-being following exposure to the natural environment as contrasted to the cities. For instance, a study on environmental preferences discovered that seeing visuals of nature settings (as opposed to those of cities) was related to mood improvement and even lower levels of stress and depression. It is crucial for urban planners to comprehend the variations in attentional demands, as well as how they affect impact in both natural and built environments, and to pay attention to their unique characteristics when designing and building the environment (Kinnafock & Thøgersen-Ntoumani, 2014). However, local cuisine can also have an impact on the physical environment because of the resources it uses, the methods of preparation, and the tastes it uses.

Eating habits may be influenced by the local neighborhood environment (Hawkesworth et al. 2017). Due to the distinctive taste of regional cuisine, this may also have an impact on how attentively tourists explore local cuisine in Kelantan. Additionally, the location of local food stores affects how many tourists are attracted to Kelantan. The surroundings, such as a restaurant or shop, will also have an impact on a visitor's attraction to these places, therefore tourist attractions depend on their intention to visit the places more than just the local cuisine. Tourists must have a pleasurable interaction, especially in terms of the restaurant's or store's cleanliness and interior design. It shows the care for physical surroundings and desire is important for a visitor to enjoy themselves while dining and a great restaurant is built on a foundation of quality food, attentive service, and a design that can be more ambiance- and comfort-oriented (Jason, 2019).

### **Excitement**

Excitement is one of the four characteristics cited by Kim et al. (2009) as motivating tourists to eat local cuisine when visiting a location. It can refer to a sensation of excitement or an exciting event. When visiting new locations, trying numerous novels and interesting meals, and engaging in many other activities, tourists will make for a great excitement. Trying new foods may be a stimulating experience and anticipating an exciting experience can make it even better (Rust & Oliver, 2000).

As a result, it is important to get the experience of tourists who are greatly influenced by the local cuisine. It serves as a distinctive and priceless source of difference that improves the experience of visitors. The purpose of the study is to investigate the significance of the local culinary experience and how it affects visitors' memorable knowledge, satisfaction, and behavioural intention (Piramanayagam & Seal, 2020). Impact, when tourists eat out, the excitement of trying something new will be felt more, even if we are unsure of how much we will enjoy it or not, as is the experience for newcomers.

## **Prestige**

Prestige is described as the respect and admiration bestowed onto someone or something as a result of their standing for greatness, achievement, or societal influence. According to Williams and Soutar (2009), the social value of a trip experience may be related to the individual recognition or prestige it brings. Visitors' social worth can be raised by bringing and introducing friends and family to tourism destinations. Chang et al. (2010) claims that dining with friends while travelling could increase social status since other people may view travellers who "have been there" and "have eaten foreign food" as having a high level of cultural capital (Chang et al., 2010; Kim et al., 2009).

When traveling, tourists surely will research food-related items and place a high priority on the uniqueness, locality, originality, and distinctiveness of local foods. All of these factors have an impact on how satisfied they are with their travel experiences (Björk & Kauppinen-Räsänen, 2016). Tourists will be satisfied and willing to share when local food standards are fulfilled. This is important because they may convince other travelers to plan to eat the local cuisine at the same time. Tourists will also know which restaurants are the best and will suggest them to friends and family or publicly on social media. As a result, the people of Kelantan will become well-known through savoring the satisfying and memorable local cuisine.

## **Escape From Routine**

Numerous studies by Davidson (2002), Fields (2003), and Passariello (1983) found that escape from everyday life is a reason for pursuing food, which is the opposite of daily activities. Escape from routine is one of nine sub-factors that have been proposed by Kim and Scarles (2009) that influence tourists' motivation toward local food consumption. Since travelling is considered a chance to get away from routine, MacCannell (1976) and Smith (1994) stated that travellers prefer eating in local places with a unique character instead of international cuisine chain restaurants.

In the prior research, it is mentioned that travelers frequently consume local cuisine to explore new things or escape from their daily routines. Tourists need something new to make them feel confident and comfortable, even though they appear to be pleased with their current life circumstances (Kim et al., 2009). Suntikul et al. (2019) argue that the promise of unique local cuisine encourages these tourists to disrupt their daily consumption habits because tourists view authentic local cuisine experiences as a method to break free from daily routines. Hence, escape from routines is the independent variable in this research.

## **Intention to Consume the Local Food**

Tourists' intentions are usually unclear and change throughout their encounters. As it relates to gastronomic tourism, this raises the possibility that the surroundings might have a significant influence on visitor behaviour and intents. Apart from that, Abdullah et al., (2018) argue that the choice to travel toward a specific location, along with the following evaluations and prospective behavioural intentions, are all part of the tourist's intention. In general, food preferences are studied as elements of human behaviour. Tourists can experience local culture and immerse themselves in its norms by partaking in the local cuisine, particularly cuisine associated with place identification, which can serve as a symbol of a destination's culture (Zhang et al, 2018).

Food choices or intentions in tourism have evolved into an important component in the expansion of tourism industries. Rozin (1996) indicated that cultural identity has a significant impact towards the intent to consume local foods and the choices of foods. Even local cuisine serves as a platform for educating tourists about the culture. The choices made by tourists will change to meet

their physical requirements and consumption patterns. There are numerous elements, such as situational and individual circumstances that have an impact on this voting behaviour.

### Research Hypothesis

The researchers hypothesis is to see whether there are any relationships between the study's dependent and independent variables.

H1: There is a relationship between physical surroundings and the intention to consume local foods.

H2: There is a relationship between excitement and the intention to consume local foods.

H3: There is a relationship between prestige and the intention to consume local foods.

H4: There is a relationship between escape from routine and the intention to consume local foods.

### Research Framework

The Figure 1 below shows the research frameworks use for this study

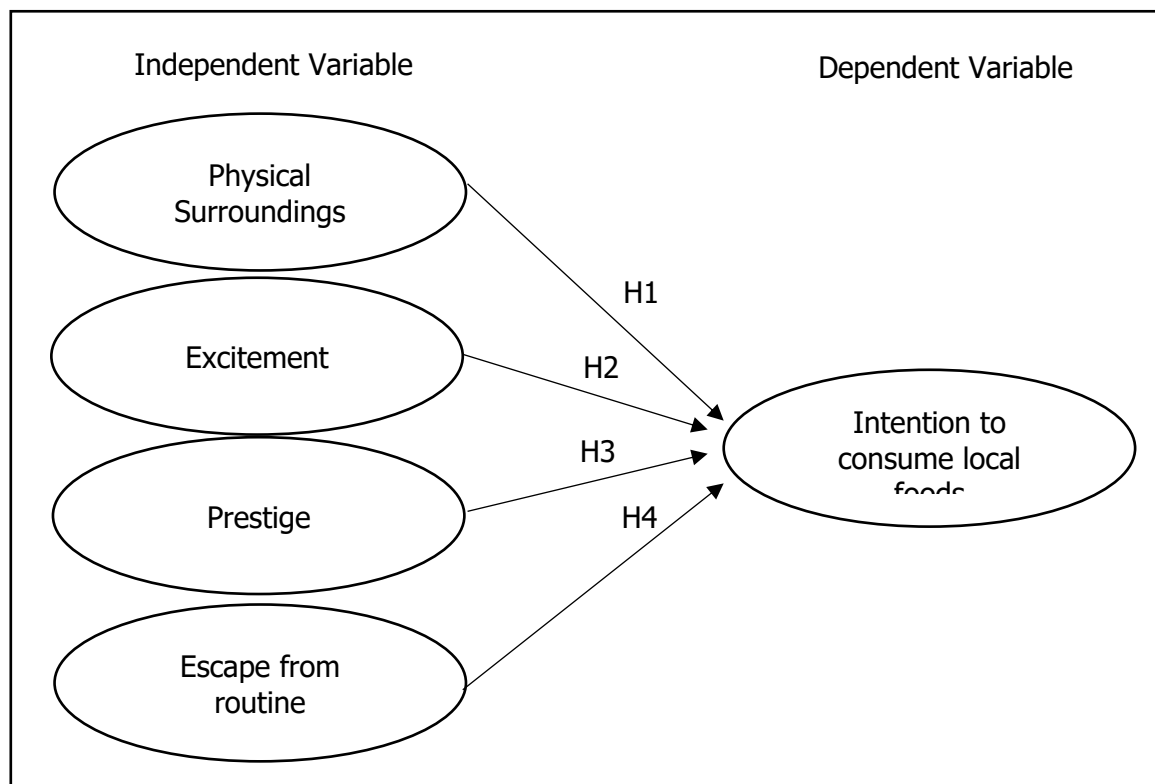

Figure 1 : Conceptual framework for intention to consume local foods.

Source: Kim et al. (2009)

## METHODOLOGY

### Research Design

In this study, a quantitative research design will be used. The process of gathering and analyzing numerical data is known as quantitative research design. Our targeted respondents 384, however the data group access from the respondents we acquired only resulted in 321 respondents and to analyze the primary data, researchers will use SPSS version 20.2 (Statistical Programmers for Social Science).

Additionally, this chapter explores the link between the variables that influence tourists to consume local food in Kelantan.

Moreover, the researchers use a questionnaire as a tool for the research instrument in this study. The researchers present the survey questions in a Google Form so that participants can respond online or through social media. To make it simpler for the respondents to understand every question in this survey two languages will be provided: Malay and English. This research question is divided into three sections which are sections A, B, and C.

Section A focuses on the demographic data of the respondents, whereas Section B relates to the independent variables, each variable contains two questions that respondents must answer. Section C, on the other hand, deals with the dependent variable and includes four questions that the responder must respond to. Typically, the Likert scale provides five possible answers to a statement that allows respondents to indicate their strength of agreement or disagreement regarding the question given. Closed-ended inquiries are types of questions that demand a straightforward response from the respondent. The question can be answered with a single word or a straightforward "yes" or "no."

## Data Collection

The primary data approach will be employed in this study to collect information. The questionnaire will be distributed using online forms created with Google Forms that can be accessed anywhere and anytime by potential respondents. Respondents have a high level of flexibility in how they complete the questions since they may use their smartphone, computer, tablet, and other devices to respond by the researchers distributing or sharing the link Google Form through social media platforms.

## Sampling

This study will utilize non-probability sampling and adapt convenient sampling from other types of nonprobability sampling. Convenience sampling is appropriate for this research since the methods are easy and affordable, and the participants are easily available. Additionally, Dörnyei (2007) supported that this type of nonprobability sampling is a sampling where participants from the target group fulfill certain practical requirements for them to be included in the study objectives.

## Data Analysis

Four types of data analysis were used in this research : descriptive statistics, reliability test, correlation analysis and frequency analysis. The researchers will use SPSS version 20.2 (Statistical Programmers for Social Science). Organize data and pie charts with SPSS, a program-based data processing and analysis system.

## FINDINGS

### Result of Demographic Analysis

Table 1: Frequency Analysis

Demographic	Categories	Frequency (N)	Percentage (%)
Gender	Male	36	11.2
	Female	285	88.8



<b>Age</b>	18-24	276	86
	25-34	33	10.3
	35-44	7	2.2
	45-54	3	0.9
	55 above	2	0.6
<b>Race</b>	Malay	281	87.5
	Chinese	10	3.1
	Indian	8	2.5
	Others	22	6.9
<b>Marital Status</b>	Single	302	94.1
	Married	19	5.9
<b>Education Level</b>	Primary School	0	0
	Secondary School	16	5
	Diploma	19	5.9
	Undergraduate or Bachelor Degree	281	87.5
	Postgraduate Degree or above	5	1.6
<b>Occupation</b>	Student	282	87.9
	Employed	32	10
	Self Employed	4	1.2
	Housewife	2	0.6
	Unemployed	5	0.3
<b>Have you ever been to or visited Kelantan before (in past 5 years)</b>	Yes	257	80.1
	No	64	19.9

Table 1 shows that females are more likely than males to be influenced to consume the local food in Kelantan. The entire number of male respondents is 36, while the total number of female respondents is 285 persons. Their combined percentage is 88.8% compared to 11.2% for the male respondents.

Out of 321 responses, the majority of the respondents were 86.0% between the ages of 18 - 24 years old, with 276 individuals completing the survey, followed by 10.3% the ages between 25 - 34 years old resulting in 33 individuals, 2.2% respondents aged between 35 - 44 years old which is 7 people meanwhile 0.9% of 3 individuals are age between 45 - 54 years old and a total of 0.6% of 2 persons aged 55 and above. According to data analysis, 18 - 24 years shows that people in that age range are more influenced to consume the local food in Kelantan.

Next, with the 87.5% and 281 respondents, Malay is the race group with the most participants in the survey, followed by 3.1% Chinese with 10 respondents. With 2.5% consisting of 22 respondents, Others group races are the third highest answering the survey, followed by 2.5% of Indians with 8 respondents. According to this data's analysis, the more race influenced to consume the local food in Kelantan is Malay people.

Out of 321 responses, 93.8% of respondents were single, with a total of 301 respondents, compared with only 5.9% of the respondents who were married, with a total of 19 respondents. This shows that mostly more females engage in answering the survey about the influence of consuming local food in Kelantan than males.

The majority of the respondents answering the survey are 87.5% from undergraduate or bachelor's degrees, with a total of 281 respondents. Followed by a total of 19 respondents, the study indicates that 5.9% are diploma students. Meanwhile, 5.0% of the secondary school participated in

this survey with only 16 respondents, and the lowest percentage of education level is the postgraduate degree or above with only 5 respondents (1.6%).

With 282 respondents, the majority of the respondents are undergraduate or bachelor's degree holders, with 87.9%. The second highest is employed with 32 respondents (10.0), followed by self-employed with 1.2% representing four respondents. The two lowest percent of occupations are housewives, with only two respondents (0.6%), and only one respondent is unemployed (0.3).

Lastly, revealing that 257 respondents opted to reply yes to the question's statement, while 64 respondents chose to respond no to the question's statement. The researchers discovered that the percentage for those who respond yes with the question's statement is 80.1% and 19.9% the respondents who respond no with the question's statement. According to this data's analysis, there are more respondents who have visited Kelantan after five years.

## Result of Descriptive Analysis

Table 2: Descriptive Analysis

Variable	Item	Mean	SD
<b>Physical Surroundings</b>	Cleanliness of the restaurants or places of destinations is important for your travel dining experience.	4.50	0.840
	Design of the restaurants is important for your travel or trip dining experience.	3.97	0.929
<b>Excitement</b>	Before going on a trip you search for the information about food first, the image of food makes you feel excited.	4.24	0.829
	When you eat out, it is exciting for you to try the most unusual items, even if you are not sure what you like.	4.02	0.899
<b>Prestige</b>	It is important for you to share photos and information of your dining experience with others through social media.	3.74	0.910
	You will go to the place of restaurants recommended by your surrounding social groups and the public.	4.10	0.791
<b>Escape From Routine</b>	Feel comfortable when you try food on a trip which is different from what you eat in your normal life.	4.03	0.858
	Your choices and behavior for dining experience during travel or trip is different from your daily life	3.95	0.877
<b>Intention to consume local food</b>	I would like to eat Kelantan local food.	4.31	0.700
	I am willing to eat Kelantan local food.	4.24	0.745
	I plan to consume local food in Kelantan.	4.19	0.779
	I expect to consume local food in Kelantan.	4.27	0.707
	I intend to eat Kelantanese local foods in the near future.	4.21	0.774
	I am willing to recommend people, family and/or friends to visit Kelantan for its food.	4.25	0.800

Table 2 shows the mean and standard deviation of independent variables and dependent variables. The data indicates that the highest mean value for the dependent variable is Question 1, with 4.31 and 0.700 standard deviation, in which respondents agreed that "they would like to eat Kelantan local food." Meanwhile, the lowest is Question 3, "I plan to consume local food in Kelantan," with a 4.19 mean value (SD=0.779).

Physical surroundings show that 'Cleanliness of restaurants or places of destination important for your travel dining experience' has the highest mean value of 4.50 (SD=0.840), followed by 'Design of the restaurant is important for your travel or trip dining experience' got a mean score of 3.97 (SD=0.929), slightly lower than the first question.

The highest mean score of excitement is 4.24 (SD=0.829), which means respondents agree, 'Before travel, you search for food, which image makes you feel excited, on social media or another medium.' Followed by the question, 'When you eat out, it's interesting that you try the most unusual items, even if you're not sure what you like' with a mean score of 4.02 and a standard deviation of 0.899.

Next, the respondents agreed with the question of prestige, which is "You will go to the restaurants recommended by your surrounding social groups, and the public" scored the highest mean value, which was 4.10 and 0.791 standard deviation. Followed by the question "Is it important for you to share photos and information about your dining experience with others through social media" yielded a slightly lower mean score of 3.74 and a standard deviation of 0.910, respectively.

The highest mean value for escape from routine is 4.03, and 0.85 indicates that respondents "feel comfortable when trying food on a trip that is different from what they eat in normal life." Meanwhile, the "Your choices and behavior for dining experiences during travel or trip is different from your daily life" only recorded a 3.95 mean score and 0.877 standard deviation.

## Result of Reliability Analysis

Table 3: Reliability Analysis

Variable	N of items	Cronbach's Alpha
Physical surroundings	6	4.23
Excitement	2	4.13
Prestige	2	3.92
Escape from routine	2	3.99
Intention to consume local food	2	4.25

The results of the reliability analysis display the number of items, and Cronbach's alpha statistic. With six items in the statistic for intention to eat local food, Cronbach's alpha is 0.934. The additional factors are the physical environment, excitement, prestige, and escape from routine; each of the variables comprises two items. Cronbach's alpha reliability analysis for the physical surroundings is 0.662, excitement is 0.720, prestige is 0.616, and escape from routine is 0.752. Hence, the reliability analysis results' overall shown that all the variables are acceptable.

## Result of Pearson Correlation Analysis

Table 4: Pearson Correlation Analysis

Hypothesis	Pearson's Correlation	Result
<b>H1:</b> There is a positive relationship between physical surroundings and the intention to consume local food in Kelantan.	0.383	Supported
<b>H2:</b> There is a positive relationship between excitement and intention to consume local food in Kelantan.	0.556	Supported
<b>H3:</b> There is a positive relationship between prestige and intention to consume local food in Kelantan.	0.418	Supported
<b>H4:</b> There is a positive relationship between escape from routine and intention to consume local food in Kelantan.	0.538	Supported

Hypothesis 1 (H1) proposed that physical surrounding show the value of Pearson's correlation at  $r = 0.383$ , meanwhile excitement in Hypothesis 2 (H2) indicate  $r = 0.556$ , prestige in Hypothesis 3 (H3) shows  $r = 0.418$  and Pearson's correlation  $r = 0.538$  in Hypothesis 4 (H4). With the significant level respectively at 0.000, which is less than the 0.05 level of significance. Thus, all proposed hypothesis were accepted. The Pearson's correlation results in the hypothesis above are supported and revealed that the independent variables namely physical surroundings, excitement, prestige, and escape from routine have a moderate positive and low positive relationship with the intention to consume local food in Kelantan. With all the significant less than  $p < 0.05$ , it is determinants of the likelihoods to consume local food while travelling.

## DISCUSSION AND RECOMMENDATION

In summary, this research explored in depth the factors that influence the intention of tourists to consume the local food in Kelantan. The purpose of this study is to answer the questions and the hypothesis. Based on the data analysis, the current study makes some recommendations for tourists, academic researchers or the community to enhance the intention of tourists to come to Kelantan.

The recommendation or suggestion for future research about this study might include classic outdoor dining areas in Kelantan, which increases the Classic Wooden Houses and Rural Scenery. Local eateries may want to think about adding outside eating areas that are a reflection of the local architecture and landscape to improve the dining experience. For customers to enjoy their meals in a lovely location, this can feature outside seating spaces, gazebos with thatched roofs, or elevated dining platforms. Physical surroundings scenic views in Kelantan are renowned for its attractive landscapes, which include lush vegetation, rivers and traditional wooden cottages.

After that, organise food celebrations and events that highlight Kelantan's illustrious local food history. In addition to a vast range of regional local food, these events may also include interactive games, live culinary demos and cultural performances. Tourists will be encouraged to discover and partake in the regional local food if a joyful and joyous environment is created. These events can draw foodies and tourists interested in the local food in Kelantan by showcasing the distinctive tastes and ingredients of the area.

Next, cooperation with the Tourism and hotel sector. Promote local cuisine experiences as part of upscale travel packages by working with tourism boards, travel companies, and the hotel sector. To draw affluent travellers looking for excellent culinary experiences, highlight the exclusivity and

prestige of these events. Collaboration with the tourist and hospitality sector creates avenues for networking and forming collaborations with key industry players. These contacts may open up more chances for cooperation, such as taking part in renowned food events, culinary contests or global culinary exchanges.

Lastly, cooking classes and workshops where people may learn the fundamental methods and dishes of traditional Kelantanese cookery. As people engage in a novel and creative activity, these hands-on encounters provide a respite from routine. Participants may become lost in the world of food, pick up new skills and experience the pleasure of cooking and eating regional cuisine. Cultural Relationship Participants in cooking lessons and seminars that emphasize Kelantanese cuisine have a greater understanding of the local way of life.

## **CONCLUSION**

In this study, the researchers aimed to investigate the factors that influence tourists' intentions to consume local food in Kelantan. They focused on four independent variables: physical surroundings, prestige, excitement, and escape from routine. The physical surroundings refer to the sensory aspects that can be perceived, such as touch, smell, sight, hearing, and taste. Trying unfamiliar food was considered an invigorating experience, and the expectation of excitement was believed to enhance the overall experience. Prestige, on the other hand, relates to the respect and admiration given to something or someone based on reputation, quality, success, or social influence. Lastly, tourists seeking an escape from their everyday routines valued local food experiences as a means of breaking away from their usual eating habits.

The findings of the study indicated that tourists did not place significant emphasis on the given factors. Instead, the data showed that tourists were more concerned with experiencing and understanding the authenticity of the local food in Kelantan. Most of them intended to taste the genuine flavors and differentiate them from widely recognized local food products. These well-known factors, therefore, influenced tourists' intentions to consume local food in Kelantan to a moderate extent. The study suggested that the environment had a substantial impact on visitors' intentions and behaviors regarding culinary tourism, as the intentions of tourists tended to shift during their experience.

According to the survey results, travelers expressed a strong desire to visit Kelantan due to their appreciation for the authenticity and excellence of the regional cuisine. Furthermore, the affordability of local eateries without compromising quality made them even more attractive to tourists. Witnessing the originality and authenticity of native cuisine in Kelantan contributed to tourists being more accepting of their own experiences.

Overall, the study concluded that the given factors, including the physical surroundings, prestige, excitement, and escape from routine, significantly influenced tourists' intentions to consume local food in Kelantan. By experiencing traditional local food, tourists could savour the authenticity of the cuisine, which played a role in preserving the food culture and heritage of Kelantan. Consequently, there is a high demand for tourists seeking local food experiences, and this research demonstrated that these factors indeed influence their intentions positively.

## REFERENCES

- Abdullah, S. I. N. W., & Lui, E. (2018). Satisfaction Drivers And Revisit Intention of International Tourists in Malaysia. *Journal of Tourism, Hospitality and Environment Management*, 3(9), 1–13.
- Akter, M., Sadekin, M. N., & Patwary, A. K. (2020). An Empirical Study on Students' Satisfaction from Mawlana Bhashani Science & Technology University, Bangladesh. *Review of Economics and Development Studies*, 6(2), 363-379.
- Al Mahmud, S. R. (2020). The effectiveness of Facebook advertisements on purchase intention of customers in Malaysia. *South Asian Journal of Social Sciences and Humanities*, 1(1), 97-104.
- Alom, S., Patwary, A. K., & Khan, M. M. H. (2019). Factors affecting the turnover intention of Bangladeshi migrants in the United Arab Emirates: An empirical study on the hotel industry. *International Journal of Innovation, Creativity and Change*, 8(3), 344-360.
- Björk, P., & Kauppinen-Räsänen, H. (2016). Local food: a source for destination attraction. *International Journal of Contemporary Hospitality Management*, 28(1), 177–194. <https://doi.org/10.1108/ijchm-05-2014-0214>
- Chang, R. C. Y., Kivela, J., & Mak, A. H. N. (2010). Food preferences of Chinese tourists. *Annals of Tourism Research*, 37(4), 989–1011. <https://doi.org/10.1016/j.annals.2010.03.007>
- Davidson, A., & Saberi, H. (2002). *The Wilder Shores of Gastronomy: Twenty Years of Food Writing* (First Edition, First Printing). Ten Speed Press.
- Dörnyei Z. (2007). Research methods in applied linguistics : quantitative, qualitative, and mixed methodologies. *Oxford University Press EBooks*. <http://ci.nii.ac.jp/ncid/BA82715592>
- Fengmin, Z., Baijun, W., Jiangtao, B., Li, L., & Patwary, A. K. (2022). Investigating revisit intention of medical tourists in China through nutritional knowledge, perceived medical quality, and trust in the physiologist: A recommendation on health tourism policy measures. *Frontiers in Public Health*, 10, 893497.
- Fields, K. (2003). Demand for the gastronomy tourism product: motivational factors. *Tourism and Gastronomy*, 50–64. <https://doi.org/10.4324/9780203218617-9>
- Given, L. M. (2008). *The SAGE Encyclopedia of Qualitative Research Methods* (1st ed.). SAGE Publications, Inc
- Hawkesworth, S., Silverwood, R., Armstrong, B., Pliakas, T., Nanchahal, K., Sartini, C., Amuzu, A., Wannamethee, G., Atkins, J., Ramsay, S., Casas, J., Morris, R., Whincup, P., & Lock, K. (2017). Investigating the importance of the local food environment for fruit and vegetable intake in older men and women in 20 UK towns: a cross-sectional analysis of two national cohorts using novel methods. *International Journal of Behavioral Nutrition and Physical Activity*, 14(1). <https://doi.org/10.1186/s12966-017-0581-0>
- Jason. (2019, January 10). One response to “4 Reasons Why Restaurant Customers Value Cleanliness as Much as Food”. Retrieved from <https://integrityservicecompanies.com/2018/11/09/4-reasons-why-restaurant-customers-value-cleanliness-as-much-as-food/>
- Kim, Y. G., Eves, A., & Scarles, C. (2009). Building a model of local food consumption on trips and holidays: A grounded theory approach. *International Journal of Hospitality Management*, 28(3), 423–431. <https://doi.org/10.1016/j.ijhm.2008.11.005>
- Kinnafick, F. E., & Thøgersen-Ntoumani, C. (2014). The effect of the physical environment and levels of activity on affective states. *Journal of Environmental Psychology*, 38, 241–251. <https://doi.org/10.1016/j.jenvp.2014.02.007>
- Li, L., Ragavan, N. A., Patwary, A. K., & Baijun, W. (2022). Measuring patients' satisfaction toward health tourism in Malaysia through hospital environment, nutritional advice, and perceived value: A study on Chinese exchange students. *Frontiers in public health*, 10, 893439.

- Li, L., Wu, B., & Patwary, A. K. (2022). How marine tourism promote financial development in sustainable economy: new evidences from South Asia and implications to future tourism students. *Environmental Science and Pollution Research*, 29, 1155-1172.
- Li, L., Wu, B., & Patwary, A. K. (2022). The psychosocial factors affecting chinese Outbound Exchange and mobility students' academic performance during COVID-19. *Frontiers in psychology*, 13, 872516.
- MacCannell, D. (1976). *The Tourist: A New Theory of the Leisure Class*. New York: Schocken.
- Marshall, M. (1996). Sampling for qualitative research. *Family Practice*, 13(6), 522–526. <https://doi.org/10.1093/fampra/13.6.522>
- Passariello, P. (1983). Never on Sunday? Mexican tourists at the beach. *Annals of Tourism Research*, 10(1), 109–122. [https://doi.org/10.1016/0160-7383\(83\)90118-4](https://doi.org/10.1016/0160-7383(83)90118-4)
- Patwary, A. K., Roy, B., Hoque, R., & Khandakar, M. S. A. (2019). Process of developing a community based tourism and identifying its economic and social impacts: An Empirical study on Cox's Bazar, Bangladesh. *Pakistan Journal of Humanities and Social Sciences*, 7(1), 1-13.
- Piramanayagam, S., Sud, S., & Seal, P. P. (2020). Relationship between tourists' local food experiencescape, satisfaction and behavioural intention. *Anatolia*, 31(2), 316–330. <https://doi.org/10.1080/13032917.2020.1747232>
- Rozin, P. (1996). The socio-cultural context of eating and food choice. *Food Choice, Acceptance and Consumption*, 83–104. [https://doi.org/10.1007/978-1-4613-1221-5\\_2](https://doi.org/10.1007/978-1-4613-1221-5_2)
- Rust, R. T., & Oliver, R. L. (2000). Should We Delight the Customer? *Journal of the Academy of Marketing Science*, 28(1), 86–94. <https://doi.org/10.1177/0092070300281008>
- Smith, S. L. (1994). The tourism product. *Annals of Tourism Research*, 21(3), 582–595. [https://doi.org/10.1016/0160-7383\(94\)90121-x](https://doi.org/10.1016/0160-7383(94)90121-x)
- Statista. (2016). *Domestic tourism expenditure of visitors in Malaysia in 2021, by product (in billion Malaysian ringgit)*. <https://www.statista.com/statistics/796314/domestic-tourism-expenditure-by-product-malaysia/>
- Sumethokula, P., Patwary, A. K., Srinuanpanc, B., Srinuanpand, C., Suwandee, P., Thammathikul, A., & Phanong, W. (2020). The potential of new tour repackaging for creative tourism among entrepreneurs in Nakhon Si Thammarat. *International Journal of Innovation, Creativity and Change*, 13(10), 1752-1771.
- Suntikul, W., Pratt, S., & Chong, Y. W. J. (2019). Factors that Influence Chinese Outbound Tourists' Intention to Consume Local Food. *Journal of China Tourism Research*, 16(2), 230–247. <https://doi.org/10.1080/19388160.2019.1625841>
- Telfer, D. J., & Wall, G. (2000). Strengthening backward economic linkages: Local food purchasing by three Indonesian hotels. *Tourism Geographies*, 2(4), 421–447. <https://doi.org/10.1080/146166800750035521>
- Williams, P., & Soutar, G. N. (2009). Value, Satisfaction and Behavioral Intentions in an Adventure Tourism Context. *Annals of Tourism Research*, 36(3), 413–438. <https://doi.org/10.1016/j.annals.2009.02.002>
- Wu, B., Liu, S., Wang, J., Tahir, S., & Patwary, A. K. (2021). Assessing the mechanism of energy efficiency and energy poverty alleviation based on environmental regulation policy measures. *Environmental Science and Pollution Research*, 28, 40858-40870.
- Wu, B., Zhai, B., Mu, H., Peng, X., Wang, C., & Patwary, A. K. (2021). Evaluating an economic application of renewable generated hydrogen: A way forward for green economic performance and policy measures. *Environmental Science and Pollution Research*, 1-15.
- Zhang, H., Li, L., Yang, Y., & Zhang, J. (2018). Why do domestic tourists choose to consume local food? The differential and non-monotonic moderating effects of subjective knowledge. *Journal of Destination Marketing & Management*, 10, 68–77. <https://doi.org/10.1016/j.jdmm.2018.06.001>



# PUSH AND PULL FACTORS OF TOURIST PARTICIPATE IN OUTDOOR ADVENTURE TOURISM

Nuurun Qamariah Mat Yunus, Purushotaman Pillai Sannase Pillai, Puterie Anies Sofiea, Mohd Asngari, Rasmi & \*Fauzan Hafiz Muhammad Safri

*Faculty Hospitality, Tourism and Wellness of University Malaysia Kelantan*  
hafiz.ms@umk.edu.my

---

## ABSTRACT

This study is to investigate the push and pull factors that influence tourists' interest in outdoor adventure tourism. Travellers have been choosing outdoor adventure tourism to have exciting adventures and get away from their daily routines. This is because someone goes to travel to feel fun and joy. So, they go to travel where they will find a peaceful place to comfort themselves. In this study of achieving this research aim are to identify the relationship between push and pull factors towards participation in outdoor adventure tourism in Malaysia. The quantitative research will use sampling methods. The distribution of online surveys and questionnaires to gather information from existing and potential customers. The Google Form could be easier to use because it only sends the link via WhatsApp. The survey offers useful data about the motives and preferences of adventure travellers, empowering industry participants to create specific promotions and improve the overall tourism experience.

**Keywords:** Outdoor adventure tourism, push factors, pull factors, tourist interest, adventures

---

## INTRODUCTION

The tourism industry includes both labor and products provided by the travel industry, as well as non-evaluated highlights that rouse the travel industry, such as common destinations (such as seashores, mountains, and woods), significant sites, and social elements. The greeting given to visitors by industry workers and the local population is also very important. The travel industry incorporates friendliness (for example, convenience, eateries), transportation (for example, aircrafts, car rental), travel support and data (for example, visit administrators, travel planners, and vacationer data centers), and attractions and entertainment (for example, heritage locales and theme, public, and wildlife) (Normann, 2013).

The term "push and pull" factors was initially mentioned in connection with travel industry inspirations through Dann (1977). It is possible that certain inner factors 'push' a person to look for travel industry knowledge, whereas the choice of which knowledge or item to seek out is influenced by external factors that 'pull' a person to seek out that experience. The desire to get away, rest, and take a break, prestige, tour, sports and recreation, and social interaction are the most typical push

factors. Pull factors emerge due to an attractiveness of the place, including its beaches, recreational spaces, and tourism attractions (Jurowski, 1994).

Another concept in the travel industry is adventure. The travel industry has embraced experience, but there is no specific definition of experience in the travel industry. However, there are many other speciality sectors in the travel industry that share the same characteristics as having worked in the travel industry, such as ecological tourism, adventure trips, or skilled travel. The majority of researchers Syuhada Farhana Adnan and Shida Irwana Omar, 2021, agree that having worked in the travel industry is a speciality part of the travel industry. Adventure travel is a troubling and confusing concept. According to the Adventure Travel Trade Association (ATTA), 1990, "experience in the travel industry is a vacationer action that incorporates active work, social trade, or exercises in nature. "Adventure tourism comes in two different forms. Which is a hard adventure and a soft adventure (Vijita S. Aggarwal, 2017).

Hard adventure refers to exercises with a diversity of danger that require extreme responsibility and high-level abilities. The travel industry includes exercises such as climbing mountains/rocks/ice, journeying, caving, and so on. Soft adventure relates to actions with an extreme risk but low degrees of danger, requiring little responsibility and beginner abilities; experienced guides lead the majority of these activities. Soft travel incorporates activities such as exploring, setting up camp, climbing, kayaking, and so on (Sato et al., 2018).

The objectives addressed in this study of achieving this research aim are:

1. To identify the relationship between push factors towards participation in outdoor adventure tourism in Malaysia.
2. To identify the relationship between pull factors towards participation in outdoor adventure tourism in Malaysia.

## **SIGNIFICANCE OF THE STUDY**

### **To The Academic Field**

Future scholars can generate and develop new knowledge and ideas based on the issues because of this study. Given that the researcher must consider all the potential outcomes of the circumstance when conducting the research, it can also help develop a more analytical thinking style. This study can be used as a guide by future academics to conduct additional research on Push and Pull in outdoor adventure tourism.

### **Practical**

There are countless ways to evaluate how well tourists participate. Using push and pull factors is one such strategy. Internal and external motivational dimensions are both investigated using the

push and pull factor technique. This contains factors that motivate people to look for adventure activities and gives the chance to evaluate factors that motivate people to look for adventure experiences in a particular location. Due to the number of locations that currently provide roughly comparable adventure activities, this is becoming more and more significant. Additionally, it can be a crucial component of the marketing of adventure tourism destinations. Therefore, the purpose of this study is to reconsider the push and pull factors that drive adventure tourism.

More research is required to fully understand some of these dynamics, and this study makes some significant additions to that understanding. Few researchers have looked at the effects of this shift, even though previous studies have demonstrated the industry's transformation. The importance of these developments for the planning, development and management of adventure tourism must be further studied. This study starts to talk about some of the ways that the sector seems to be changing, but it has numerous limitations. It is crucial to carry on with this study in different geographic settings and potentially with different research methodologies.

## **LITERATURE REVIEW**

### **Push Factor**

Push factors are tourists' behavioral contracts that affect their decision to visit a location or attraction. An individual's internal reasons that propel them to seek out a certain travel experience are referred to as push factors. When someone travels, experiences new things, or satisfies wants and desires, it is a result of internal stimulation. Push factors have been seen to be useful in explaining the desire for travel, as they are recognized as the starting point of understanding tourists' behavior (Crompton, 1979). It is a psychological reason from within that drives a person's desire to travel. The majority of push factors are internal motivators, such as the need for solitude, leisure, status, physical fitness, adventure, and interpersonal contact.

### **Pull Factor**

Pull factors are the elements that attract someone to travel. Pull factors are outside causes that have an impact on a person's effort to satisfy a desire or requirement. One will select a location based on their requirements and preferences. Pull factors are things that take people from other places to a new region. Once people have made the decision to travel, their motive is what drives them to a specific location. Pull factors emerge due to the attractiveness of a destination, including beaches, recreation facilities and cultural attractions (Uysal and Jurowski, 1994). Traditionally, pull factors are considered more decisive in explaining destination choice (Bello and Etzel, 1985).

## **Outdoor Adventure Tourism**

Our emotional and mental health can be improved by being in nature. A Stanford University study (Jordan, 2016) found that spending time outdoors can reduce stress levels, reduce anxiety, and possibly even reduce the risk of depression. Hard adventure activities and soft adventure activities are two different categories of adventure tourism activities. A tourist vacation that combines at least two of the following three components, such as physical exercise, exposure to the outdoors, and cultural education, is referred to as adventure tourism. It is common for visitors to be exposed to risk and require some abilities.

## **The Relationship Between Independent Variable and Dependent Variable Participate in Outdoor Adventure Tourism**

Let consider research into the relationship between the relaxation by events and activities that affect outdoor adventure tourism. In this case, the dependent variable is relaxation by events and activities, while the independent variable is the effect of outdoor adventure tourism. The benefits of relaxation by events and activities allow us to improve our physical and mental health. Engaging in challenging activities forces us to focus our energy on what we are doing at the time. For example, people can do yoga, meditation or music and art therapy. Ultimately, this helps relieve overall stress levels.

People traveled in ancient times to explore sea routes, new destinations, even new countries. Culture is a key factor in expressing the proper kind of connection, but there also must be enough communication for it to work. Commercial adventure travel, on the other hand, is a recent development in which tourists employ expert tour operators to offer a variety of technical assistance, equipment, and cultural and environmental interpretation. For instance, many want to escape their daily routine by participating in outdoor activities like cycling, hiking, and kayaking. They engage in this behaviour to decompress or get rid of stress.

Going outside helps people feel less stressed. As they travel through some of the most breathtaking landscapes on earth, all of life's burdens will vanish. Recent years have seen a quicker global growth in adventure tourism because of new tourist destinations. This makes it possible for new areas to advertise themselves as truly unique and attract travelers looking for unique and outstanding experiences. Everyone has a smile on their face when they go back after an adventure because they are happy as a result. Backpacking, camping, and sailing are a few examples. They may take in the surroundings while engaging in these hobbies, unwinding from the stress of the outside world.

## Research Hypothesis

From the conceptual participating, independent variable was determined as push and pull factors of tourists participating and a dependent variable is outdoor adventure tourism. Based on the variable above, these hypotheses are defined as follows:

H1: There is a relationship between push factors towards participating in outdoor adventure tourism in Malaysia.

H2: There is a relationship between pull factors towards participating in outdoor adventure tourism in Malaysia.

## Research Framework

The following is the conceptual framework for this study. The two factors which push and pull factors that will comprise the proposed independent variable (IV) are as follows. Outdoor adventure tourism in Malaysia is the dependent variable (DV).

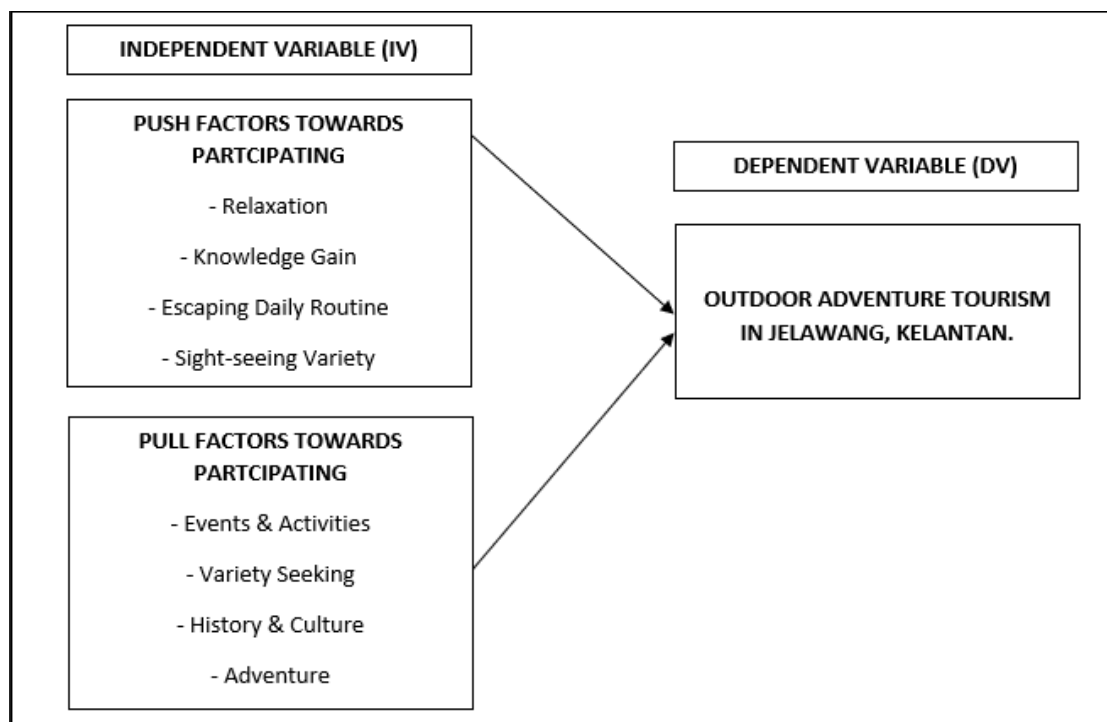

Source: (Aref et al., 2010)

Figure 2.6: Conceptual Framework

## **METHODOLOGY**

### **Research Design**

This study uses a quantitative research design. Quantitative research is dealing with data, logic, and an objective point of view. It highlights numerical and static facts as well as intricate, convergent reasoning, in contrast to varied thinking, which is the unrestrained growth of multiple distinct opinions about a particular area in an unstructured manner. Quantitative research is the examination, analysis, and interpretation of the observations with the purpose of understanding the meanings and patterns of relationships. It is about asking people for their opinions through questionnaires in an efficient way so that the researcher can produce hard facts and statistics to guide. Descriptive, correlational, causal comparative/quasi-experimental, and experimental are the four subtypes of quantitative research. tries to prove cause-and-effect connections between variables. Data will be quantified using quantitative research, and outcomes from a sample will be applied to the entire 17 population. It can also be used to assess the presence of various points of view and suggestions in specific samples.

Finally, online surveys and questionnaires will be distributed to existing and potential customers as part of quantitative research to collect information. The outcomes can be represented numerically.

### **Data Collection**

This survey used questionnaires to obtain data through a survey. A survey is a digital questionnaire that collects quantitative data. This method is to be employed because questionnaires are usually cheaper to conduct, relatively easy to administer because they are standardized and relatively free from several types of error and it is an efficient way of collecting information from a large number of respondents.

### **Sampling**

Non-probability convenience characterizes the sampling strategy. It shows that the research population does not have the probability to be represented in the sample of Sekaran and Bougie (2013). As a result, this study will use the convenience sampling technique. The term "convenience sampling" refers to a method used by researchers to collect data from a readily accessible set of respondents for market research. Because it is so fast, simple, and affordable, it is the most frequently used sampling procedure. If members choose to be part of the sample, they are often easy to contact.

### **Data Analysis**

Data analysis refers to the process of inspecting, cleansing, transforming, and modeling data to uncover meaningful insights, draw conclusions, and support decision-making. It involves the application of various statistical and computational techniques to analyze data sets and extract valuable information from them. To examine the primary data, researchers will use the programme

Statistical Programmers for Social Science (SPSS) version 26.0. SPSS is a data processing and analysis programme that lets you create tables and pie charts. Computers assisted researchers in reducing the amount of effort required to determine information and perform quantitative analysis quickly and easily. To evaluate quantitative data, the researcher employs descriptive statistics, reliability statistics, Pearson's correlation, and hypothesis testing.

## **FINDINGS**

### **Response Rate**

According to statistics, the "number of respondents who complete a questionnaire compared to the number assigned, usually expressed as a percentage," is known as the response rate. According to the 2009 edition of the OECD Glossary of Statistical Terms, "Response rate Definition," the response rate can also be applied to specific questions. Generally, the response rate refers to the quantity of replies a researcher receives after delivering questionnaires to participants. The response rates will also be calculated by separating the sample's total number of qualified participants by the quantity of valid responses.

A study's response rate is important since it establishes the validity of it. A low response rate might impact the reliability test and reduce the statistical power of the data obtained. As a consequence, it will have an impact on the study by providing the study's conclusions unreliable, which also shows that the findings of the research cannot be applied to the larger population. Therefore, a high response rate is partly influenced by how accessible and reachable the target audience is. The response rate will be low and vice versa if the reachability and availability are poor.

In this study, WhatsApp was used for spreading the surveys online. The surveys were answered by respondents with 217 questionnaires that distributed in total, which represents 100% of the questionnaires issued. Additionally, the researchers were able to compile all 217 completed surveys, total 217 dispersed questionnaires and a 100% response rate. There were neither any shared surveys that were not returned nor any received replies that were invalid. The identical number of surveys that were distributed were successfully collected, and there was a 100% response rate.

### **Demographics Characteristics of Respondent**

There were 217 sets of valid questionnaires distributed and all the questionnaires were successfully collected back. In the frequency distribution analysis, there were 4 items of valid questionnaires that had been asked to the respondents including gender, age, income level, and platform to reach Jelawang, Kuala Krai, Kelantan. All the frequency distribution analysis was to category out the demographic profile of respondents.

Table 4.3: Demographics Characteristics of Respondent

		Frequency	Percentage	Cumulative Percentage (%)
<b>GENDER</b>	Male	85	39.0	39.0
	Female	132	61.0	100.0
	<b>TOTAL</b>	<b>218</b>	<b>100.0</b>	<b>100.0</b>
<b>AGE</b>	Under 18 years	2	0.9	0.9
	18 – 23 years	187	86.2	87.1
	24 -29 years	16	7.37	94.47
	30 – 35 years	5	2.31	96.78
	36 – 40 years	4	1.84	98.62
	41 years above	3	1.38	100.0
<b>TOTAL</b>	<b>218</b>	<b>100.0</b>	<b>100.0</b>	
<b>INCOME LEVEL</b>	No income	183	84.3	84.3
	Below RM1000	11	5.01	89.31
	RM1001 – RM2000	9	4.15	93.46
	RM2001 – RM3000	7	3.21	96.67
	RM3001 – RM4000	4	1.84	98.51
	Above RM4000	3	1.49	100.0
<b>TOTAL</b>	<b>218</b>	<b>100.0</b>	<b>100.0</b>	
<b>PLATFORM TO REACH JELAWANG</b>	Social media	83	38.2	38.2
	Friends	88	40.6	78.8
	Google search	38	17.5	96.3
	Others	8	3.7	100.0
	<b>TOTAL</b>	<b>218</b>	<b>100.0</b>	<b>100.0</b>

Male respondents accounted for 85 of the totals and that was 39% while female respondents accounted for 132 of the totals and that was 61%. Among respondents out of 217 respondents, the highest of respondents was female which is 132 that consists of 61%. While the lowest number of respondents was male which is 85 that consists of 39%.

The survey had 217 responses, with 2 respondents under the age of 18 (0.9%), 187 respondents between the ages of 18-23 (86.2%), 16 respondents between the ages 24-29 (7.37%), 5 respondents between the ages 30-35 (2.31%), 4 respondents between the ages 36-40 (1.84%), and 3 respondents above the age of 41 (1.38%). The highest of respondents were 18-23 years old that consists of 86.2% while the lowest number of respondents fall to 41 years above that consists of 1.38%.

They were 183 respondents (84%) who had no income. 11 respondents (5.01%) who had below RM1000 income and 9 respondents who had answered the questionnaire (4.15%) that income levels ranging from RM1001 to RM2000. There are 7 respondents (3.21%) who have an income between RM2001 to RM3000 already respond. There are 4 respondents who have answered the questionnaire, (1.84%) have an income level between RM3001 to RM4000 and 3 respondents (1.49%) an above-average income RM4000. The highest of respondents had no income that consists of 84.3% while the lowest was 3 that consists of 1.49%.

Social media respondents accounted for 83 of the totals and that was 38.2%. Friends' respondents for 88 of the totals and that consisted of 40.6%. Google search respondents accounted for 38 of the totals and that was 17.5%. Other respondents accounted for 8 of the totals and that was 3.7%.



The frequency and percentage of the responders based on the platform to reach Jelawang, Kelantan is the highest of respondents was friends which is 88 that consists of 40.6%. While the lowest number of respondents was others which is 8 that consists of 3.7%.

## Descriptive Analysis

Table 4.4: Independent Variable and Dependent Variable

VARIABLE	N	MEAN	STANDARD DEVIATION
Push factor	217	4.3738	.57735
Pull factor	217	4.4055	.53913
Dependent variable	217	4.4597	.62670

The table displays the descriptive analysis for the independent variable (push and pull factors) and dependent variable. The pull factor has the highest mean score of any independent variable and that is 4.4055. The dependent variable, with a score of 4.4597, comes in second.

As we can see that district Jelawang, Kelantan is also one of the tourist destinations where visitors can explore its cultural resources such as the Geopark at Gunung Stong shows the highest mean score. The question indicates that the reasons will increase the demand of the place.

## Reliability Test

A technique for examining a scale's internal consistency is the reliability test. To determine the level of consistency, we utilized Cronbach's alpha coefficient as the indication. Dependability analysis was used to examine the questionnaires' reliability. The survey's reliability and internal logic were confirmed using Cronbach's Alpha analysis. The reliability test measures how well test outcomes stand up over time from measurement of something. It covers how consistently the same set of test takers performs when the identical test is administered on several days (Rosaroso, 2015).

Table 4.5.2: Result of Reliability Coefficient Alpha for the Independent Variables and Dependent Variable

Variable	Reliability Cronbach's Alpha	Number of items	Results
Push Factor	0.931	8	Excellent
Pull Factor	0.902	8	Excellent
Outdoor Adventure Tourism	0.904	4	Excellent

Table 4.5.2 of the IBM SPSS Statistics version 26 findings revealed the importance of both independent and dependent variables in this analysis. The overall Cronbach's Alpha Coefficient for

the independent and dependent variables in this study was displayed in the table. All the variables, it may be considered, were more than 0.9. Consequently, the presented result is trustworthy and may be accepted in this analysis.

The push factor was assessed using eight questions. According to Table 4.5.2, Cronbach's Alpha for this section's question was 0.931, which was outstanding. As a result, the coefficients for the push factor were reliable. Following that, eight questions were asked to assess the pull factor. In this area, the Cronbach's Alpha value is 0.902, which is considered as excellent. Therefore, the coefficients generated for the pull factor were reliable.

In addition, four questions were used to evaluate the reliability variable, which influenced outdoor adventure tourism. Cronbach's Alpha was 0.904, which was regarded as excellent for this division's question. As a result, the coefficients calculated for the reliability factor were reliable. Since the Cronbach's Alpha value for such variables surpassed 0.9, the questionnaires are exceedingly reliable, as well as the research can move forward. Overall, the reliability found that the participants had a good understanding of the questions, implying that questionnaires were adequate for this investigation.

## **DISCUSSION AND RECOMMENDATION**

### **Discussion**

Most respondents agree the activities on adventure tourism were very extreme and attractive. The research explains more about the result of the factor study that showed that the respondent in this study perceived that pull factors had a major impact on outdoor adventure tourism. Based on other studies, the attention of arts, culture, history, and heritage was too common for a destination to attract more tourist arrival because typically tourists are more experienced with new things while learning about the destination through arts and history to increase their knowledge (Gunlu et. al, 2009).

Other than that, the arrival of tourists increases the economy, and it gives benefit to the region or country as it provides an opportunity for job creation and as money comes into the event destination areas which in turn encourage establishment of new enterprise and market a more positive image in an area (Zaei, M., 2013). But this result shows that pull factors affect economic impact but pull factors are considered as small issues of economic impact in this research. Besides, when cultural events are held, there are many stalls that promote job opportunities, especially for fresh graduates. For example, the fresh graduates around Bukit Jelawang area can take this opportunity to find their job opportunity for their future.

Through this, pull factors may affect outdoor adventure tourism. Beautiful natural resources, which also refer to the strategically relatedness of a place in the motivation of tourists, are usually a strong "pull" component in the idea of tourism resources. Researches that found a significant relationship between pull factors and outdoor adventure tourism.

## **Recommendation**

Theoretically, this study has contributed to the literature by highlighting the push and pull factors of tourists participating in outdoor adventure tourism. Based on the survey conducted, to explore their motivation to engage in outdoor adventure tourism activities in Jelawang. There are several suggestions for improvement to increase overall visitor motivation.

The promotion of Jelawang's distinctive features, such as its picturesque landscapes, biodiversity, and cultural heritage, to draw tourists interested in adventure travel, is one of the push factors that encourage visitors to engage in outdoor adventure tourism in Jelawang, Kelantan. Additionally, design multiple adventure tourism packages that accommodate various interests and skill levels, including pursuits like hiking, rock climbing, river rafting, and wildlife observation. Additionally, increase accessibility. To make it simpler for travelers to reach Jelawang, improve connection and transportation infrastructure. For instance, improving roads. Enhance the standard and condition of the current roads going to Jelawang, making sure they are well-maintained, clearly marked, and appropriate for various vehicle types. Informational signs: To direct people to Jelawang, install clear signs at important transportation hubs and along main thoroughfares. Give precise and current information on available options, timetables, and costs for transit. Tourists will have easier access to Jelawang by improving transportation infrastructure and connectivity, which can draw more visitors and support the expansion of outdoor adventure tourism in the region.

Developing high-quality adventure facilities is one of the suggestions for the pull factors that entice visitors to partake in outdoor adventure tourism in Jelawang, Kelantan. To draw adventure seekers, make investments in the construction of well-maintained adventure amenities, such as hiking trails, climbing walls, and camping grounds. Next, offer qualified instructors and guides. Make sure that there are experienced and competent tour guides available who can give visitors engaging in outdoor adventure activities a safe and enjoyable experience. Last but not least, work with regional groups. Work with local groups to provide genuine cultural encounters for visitors, such as homestays, meals prepared according to tradition, and cultural performances.

## **CONCLUSION**

In conclusion, the participation of tourists in outdoor adventure tourism is influenced by a combination of push and pull factors. Push factors represent the internal motivations and desires of individuals, including the desire for personal challenge, relaxation, knowledge gain, escaping daily

routine, sight-seeing variety. On the other hand, pull factors are external attractions that draw tourists to engage in outdoor adventure tourism, such events & activities, variety seeking, history & culture, and adventure.

Research on this topic has revealed that adventure tourists are driven by the desire for personal growth, the opportunity to escape and relax, the allure of scenic beauty and nature, the fascination with cultural immersion, the potential for social connections, the emphasis on environmental sustainability, and the pursuit of personal development and well-being.

Understanding this push and pull factors is essential for tourism stakeholders, as it enables them to tailor their offerings to meet the diverse motivations and preferences of adventure tourists. By highlighting the excitement, challenges, natural beauty, cultural richness, and sustainability of outdoor adventure tourism, destination marketers and operators can effectively attract and cater to the needs of this niche market. Ultimately, the fusion of personal motivations and external attractions creates fulfilling and memorable experiences for participants in outdoor adventure tourism.

(4374 words)

## REFERENCES

- Akter, M., Sadekin, M. N., & Patwary, A. K. (2020). An Empirical Study on Students' Satisfaction from Mawlana Bhashani Science & Technology University, Bangladesh. *Review of Economics and Development Studies*, 6(2), 363-379.
- Alom, S., Patwary, A. K., & Khan, M. M. H. (2019). Factors affecting the turnover intention of Bangladeshi migrants in the United Arab Emirates: An empirical study on the hotel industry. *International Journal of Innovation, Creativity and Change*, 8(3), 344-360.
- Aref, B., Al, M., Mohammad, H., Puad, A., & Som, M. (2010). An Analysis of Push and Pull Travel Motivations of Foreign Tourists to Jordan. *International Journal of Business and Management*, 5(12).  
<https://pdfs.semanticscholar.org/cd93/2a25de7dedabe403d6cf09621dc6e03fd55f.pdf>
- Bello, D. C. And Etzel, M. J. (1985) The rate of novelty in pleasure travel experiences. *Journal of Travel Research* 24(1), 20-26.
- Crompton, J. (1979) Motivations for pleasure vacation. *Annals of Tourism Research* 6(4), 408-424.
- Dann, G. (1977), Anomie, ego-enhancement and tourism. *Annals of Tourism Research* 4(4), 184-194.
- Fengmin, Z., Baijun, W., Jiangtao, B., Li, L., & Patwary, A. K. (2022). Investigating revisit intention of medical tourists in China through nutritional knowledge, perceived medical quality, and trust in the physiologist: A recommendation on health tourism policy measures. *Frontiers in Public Health*, 10, 893497.
- Günlü, E., Yağcı, K., & Pınar, I. (2013). *Preserving cultural heritage and possible impacts on regional development: Case of Izmir*.
- Hazbar, A. M. H., Alem Mohammed, A., & Karim, A. K. A. (2019). An Empirical Study of Factors Influencing hotel customers' online booking Intention. *مجلة العلوم التربوية و الدراسات الإنسانية*, (5), 1-17.

- Jordan, R. (2016, April 9). University, S. Stanford researchers find mental health prescription: Nature. Stanford News; Stanford University. <https://news.stanford.edu/2015/06/30/hiking-mental-health-063015/>
- Jurowski, M. U. (1994). Testing the push and pull factors. *Annals of Tourism Research*, 21(4), 844 - 846. doi:[https://doi.org/10.1016/0160-7383\(94\)90091-4](https://doi.org/10.1016/0160-7383(94)90091-4)
- Li, L., Ragavan, N. A., Patwary, A. K., & Baijun, W. (2022). Measuring patients' satisfaction toward health tourism in Malaysia through hospital environment, nutritional advice, and perceived value: A study on Chinese exchange students. *Frontiers in public health*, 10, 893439.
- Li, L., Wu, B., & Patwary, A. K. (2022). How marine tourism promote financial development in sustainable economy: new evidences from South Asia and implications to future tourism students. *Environmental Science and Pollution Research*, 29, 1155-1172.
- Li, L., Wu, B., & Patwary, A. K. (2022). The psychosocial factors affecting chinese Outbound Exchange and mobility students' academic performance during COVID-19. *Frontiers in psychology*, 13, 872516.
- Normann, M. M. (2013). The link between travel motives and activities in nature-based tourism. *Tourism management*, 68(2), 3. doi:DOI 10.1108/TR-02-2013-0004
- Patwary, A. K., Roy, B., Hoque, R., & Khandakar, M. S. A. (2019). Process of developing a community based tourism and identifying its economic and social impacts: An Empirical study on Cox's Bazar, Bangladesh. *Pakistan Journal of Humanities and Social Sciences*, 7(1), 1-13.
- Rosaroso, R. C. (2015). USING RELIABILITY MEASURES IN TEST VALIDATION. *European Scientific Journal, ESJ*, 11(18). Retrieved from <https://eujournal.org/index.php/esj/article/view/5847>
- Sato, S., Kim, H., Buning, R. J., & Harada, M. (2018). Adventure tourism motivation and destination loyalty: A comparison of decision and non-decision makers. *Journal of Destination Marketing & Management*, 8, 74–81. <https://doi.org/10.1016/j.jdmm.2016.12.003>
- Sekaran, U., & Bougie, R. (2013). *Research Methods for Business*. Sixth Edition.
- Sumethokula, P., Patwary, A. K., Srinuanpanc, B., Srinuanpand, C., Suwandee, P., Thammathikul, A., & Phanong, W. (2020). The potential of new tour repackaging for creative tourism among entrepreneurs in Nakhon Si Thammarat. *International Journal of Innovation, Creativity and Change*, 13(10), 1752-1771.
- Syuhada, F. A., & Shida, I. O. (2021). Assessing The Ecotourists Satisfaction of Ecolodges: A Case Study of Tadom Hill Resort, Malaysia. *Sustainable Tourism International Journal (STIJ)*, 1, 63-72.
- Uysal, M., & Jurowski, C. (1994). Testing the push and pull factors. *Annals of tourism research*, 21(4), 844-846.
- Vijita S. Aggarwal, M. H. (2017, March 7). satisfaction level of adventure tourists in India: an empirical study of perception of tourists and other stakeholders. *International Journal of Leisure and Tourism Marketing*, 2, 92-110. doi:<https://doi.org/10.1504/IJLTM.2011.038883>
- Wu, B., Liu, S., Wang, J., Tahir, S., & Patwary, A. K. (2021). Assessing the mechanism of energy efficiency and energy poverty alleviation based on environmental regulation policy measures. *Environmental Science and Pollution Research*, 28, 40858-40870.
- Wu, B., Zhai, B., Mu, H., Peng, X., Wang, C., & Patwary, A. K. (2021). Evaluating an economic application of renewable generated hydrogen: A way forward for green economic performance and policy measures. *Environmental Science and Pollution Research*, 1-15.
- Zaei, M. (2013). The impacts of tourism industry on host community. *European Journal of Tourism Hospitality and Research*.

# **Factors Influence Tourists' Selecting Melaka As Holiday Destination**

**Rasmini binti Ladampang, Salman bin Sabar, Savivarthini A/P Venugopal,  
Seri Najwa Amira binti Hamirudin & \*Hazzyati binti Hashim**

*Faculty Hospitality, Tourism and Wellness, Universiti Malaysia Kelantan*

*Corresponding email: [h20a1725@siswa.umk.edu.my](mailto:h20a1725@siswa.umk.edu.my), [h20a1742@siswa.umk.edu.my](mailto:h20a1742@siswa.umk.edu.my),  
[h20a1744@siswa.umk.edu.my](mailto:h20a1744@siswa.umk.edu.my), [h20a1747@siswa.umk.edu.my](mailto:h20a1747@siswa.umk.edu.my), [hazzyati@umk.edu.my](mailto:hazzyati@umk.edu.my)*

## **ABSTRACT**

This study was conducted to determine the factors that influence tourists' Selecting Melaka as Holiday Destination. The primary purpose of this study to examine key elements that affect tourists' holiday decisions regarding where to travel in the Melaka, one of the states located in Malaysia. The tools that used to conduct this research is quantitative research in descriptive design to measure the data collected during the study. The sample size of the respondent was 384 and the total collected who had answered the questionnaire through Google Form was also 384 respondents. The questionnaire shared through all social media platforms. It is quite simple for distributing and gathering data from responders in this manner. Thus, This work may be useful to other researchers in future endeavors to investigate the factors that influence tourists' Selecting Melaka as Holiday Destination.

**Keywords: Melaka, Destination factor, Food, Infrastructure Facilities.**

## **INTRODUCTION**

The first chapter contains the background of the study followed by the problem statements, research objectives, research questions, significance of the study, definitions of terms, and ends with the summary. The background of the study includes the theories, concepts, words and ideas of a topic or issue. A problem statement is a concise and straightforward statement that defines the symptoms of a specific problem that the researchers intend to investigate. The research objectives are declarations of goal or intentional activities can be described as acts taken in response to the supplied questions. Significant broad questions may be complemented by preliminary inquiries on study subjects. Furthermore, the significance of the study might be described represents the amount that the researchers assisted in modifying a thought, enhancing understanding or establishing a new theory in a given sector of research. The definition of terms includes both independent and dependent variable.

When travelers pick where to go, the choice of their vacation destination might be considered to be crucial. The journey will be exhausting without a specific destination because there is no direction. When flaws in a sector can be found, changes can be done to prevent issues that might damage the reputation of that organization. The enhancements made will bring more tourists to a certain location. Because Melaka may have decent accommodations or has numerous destinations nearby that make it easy to move from one place to another in Melaka, the destination factor helped to increase the number of visitors. Food tourism is a developing trend that places a special emphasis on tasting regional identities that are authentic and traditional, giving local service providers and producers a platform. Infrastructure contributes to economic growth through boosting efficiency and providing amenities that enhance people's quality of life. The improvement of infrastructure amenities will increase the influence of vacationers visiting Melaka.

The objective of this research are:

1. To examine the relationship between destination factors towards Melaka as Destination Selection.
2. To examine the relationship between food factors toward Melaka as Destination Selection.
3. To examine the relationship between infrastructure facilities factors towards Melaka as Destination Selection.

## **Significant of the Study**

### ***Researcher***

This research will assist travelers who require more knowledge about Melaka, particularly those who are visiting the city for the first time or who want to travel there. Every traveler needs to know why they are going somewhere, what they hope to get out of the trip, and what factors led them to choose to visit Melaka.

### ***Study***

This study aims to identify the elements that influence tourists' decisions to travel to Melaka. The researcher thinks that this study would encourage visitors to choose Melaka as their vacation spot and enhance their desire to do so. The results of the survey will be used to assess the options available to visitors to Melaka, determine whether Melaka is the best choice for their destination selection, and ensure that requirements for infrastructure, food, and lodging are met. The typical behavioral objectives relating to the tourism business at vacation spots near Melaka.

## **LITERATURE REVIEW**

### **Destination Selection**

Destination selection is one of the most important aspects of having a great travel experience. The destination selection was affecting the destination factor (refer to Melaka), food, and infrastructure facilities. There is a relationship between destination selection and destination factor, food, and infrastructure facilities. Destination selection, usually the choice of destination that meets the standard of tourists is the best place and worth their money, experience, and energy. The choice of destination should be that tourists will prefer a cheap destination area that may be close to their hometown but a historical site visit, suitable for all ages and the safety risk area. Destination selection is actually one of the important factors that influence tourists' choosing their holiday destination selection to help Melaka grow more, for the Destination factor (Melaka) the food in Melaka, and Melaka infrastructure facilities.

### **Destination Factor**

The researcher can establish a link between destination factor and factor affect destination selection in Melaka. Melaka's own destination factor refers to how Melaka can persuade people to visit Melaka as a vacation location. Many travellers value their vacation experience, particularly the quality of their accommodations. The key goal for tourists who come on vacation to Melaka or anywhere else as a holiday destination is the quality of accommodation, and how Melaka (Destination's factor) influences tourists' decision to make Melaka their destination of choice. Melaka is essential in providing the best accommodation for tourists, including as hotels, resorts, and homestays, as well as lodging locations that are close to other surrounding destinations, making it easier for tourists to transfer from one destination to another. The ease with which tourists can get to

a particular destination influences their decision to visit Melaka. Traffic congestion also has an impact on tourist vacations.. Melaka is a densely populated location with a tiny land area compared to other Malaysian states such as Johor, Selangor, and Perak.

## **Food**

In Malaysia, food has a significant impact on where people decide to go. The country is well-known for its extensive and diverse culinary scene, which attracts traveller from around the globe. Moreover, the tourists would receive valuable experience from their food consumption in a destination (Nasir et al., 2021). The unique combination of Malay, Chinese, Indian, and indigenous cuisines result in a fascinating tapestry of flavour and dining experiences. Melaka's status as a gastronomic heaven influences many travellers' choose Melaka as their destination selections. They want to experience the true flavour of the land, eat local cuisine, and try local specialties. From inexpensive fast-food restaurants to luxury dining facilities, Melaka provides a wide range of culinary options to suit all tastes and price ranges. Due to positive reviews and mouth-watering food images submitted by other traveller, Melaka may be an alluring destination for foodies. Melaka hosts a variety of food-related festivals and events every year that bring tourists from all over the world. For instance, the annual Melaka Food Festival showcases a range of regional specialties, providing guests with a unique opportunity to experience the city's culinary culture in a pleasant and lively atmosphere.

## **Infrastructure Facilities**

Infrastructure facilities in tourism are physical aspects that are created and built to accommodate visitors. Plenty of researchers have proposed a theoretical link between growth in tourism and infrastructures. Infrastructure facilities are widely recognised as an essential component of tourism, playing a vital role in attracting tourists. Thus, tourism infrastructure facilities are the foundation of tourism development. Investment in infrastructure is crucial for increasing visitor numbers and adding to guest enjoyment and enthusiasm. By ensuring the required services to guests, infrastructure, as an essential part of regional tourism, is especially crucial for prospective tourism expansion and the greater advancement of tourist destinations. Many researchers have confirmed the clear link between tourist growth and infrastructure in philosophical terms and practise. Infrastructure facilities include ancillary and supplementary facilities, equipment, systems, procedures, and resources required for the operation of any tourist attraction, such as ensuring that the restrooms are clean and that the infrastructure is well-maintained and up to date.

## **Research Hypothesis**

The hypothesis of the research is made based on the factors of the study such as destination factor, food and infrastructure facilities that affect the factor selecting holiday destinations in Melaka. Based on the study, the hypothesis had been created and to be tested.

**H1:** There is a relationship between destination factor and destination selection in Melaka.

**H2:** There is a relationship between food and destination selection in Melaka.

**H3:** There is a relationship between infrastructure facilities and destination selection in Melaka.



## Research Framework

Researchers have proposed a framework to study the factor influencing tourists selecting Melaka as holiday destination, based on the previous literature review. Hence, as seen below the structure.

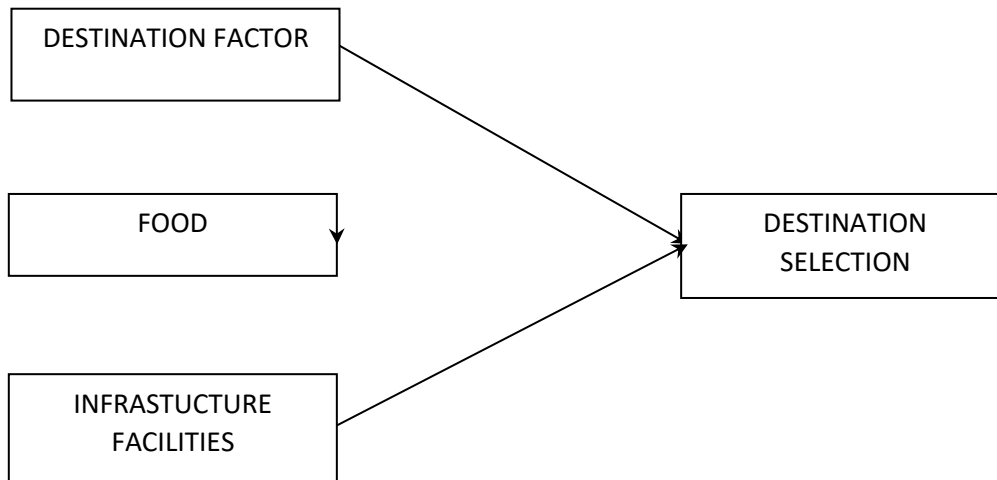

## METHODOLOGY

### Research Design

In this research, the tools that will be used is quantitative research in descriptive design to measure the data collected during the study. Quantitative research design is the process of gathering data to find an informational design to determine who, where, and what they want to know in a study (Bhandari, 2020). The researcher will use this method to determine the destination factor, food, and facilities infrastructure are the factors influencing tourist's selecting Melaka as holiday destination.

### Data Collection

The data collection method was focused on the primary and secondary. Primary data obtained from the questionnaire forms which were distributed to 384 respondents. It describes the demographic profile of visitors, discusses elements impacting local tourists' travel destination choices, and includes topics linked to tourists' destination preferences. After being created online with Google Form, the surveys will be sent via the WhatsApp network. Meanwhile, secondary data was acquired from books, journals, and the internet.

### Sampling

The sampling method used was a non-probability sampling method. The respondents were domestic tourists traveling to Melaka state. The Sampling method consisted of the aspect of research population, sample, and location in obtaining the information and data that researchers analysed to obtain the results.

Non-probability type sampling procedures are commonly used by researchers in quantitative research. Non-probability sampling involves the selection of a sample from a population selected on the basis of their expertise in the subject investigated.

### 3.3.1 Research Population

The population of this study consisted of domestic tourists who ever travel in Melaka with a total of 9,098,000 in 2021 (CEIC DATA analysis from Department of Statistic Malaysia Official Portal, 2021).

### 3.3.2 Research sample

A total of 384 sets of questionnaires were distributed to the domestic tourist who ever travelled to Melaka. This was chosen based on the table by Krejcie and Morgan (1970). The questionnaire forms were for analysis purposes. Data obtained were analysed using the descriptive analysis method.

**Table 1 : Sampling frame**

Item	Total
Research Population	9,098,000
Population Sample	384

## Data Analysis

Descriptive analysis methods were used in this study. The use of descriptive analysis was to determine the factor influencing tourists choosing Melaka as holiday destination. . It is a quantitative method and the data obtained were analysed using the Statistical Package for Social Science (SPSS Version 25.0) software. Different forms of reliability can be estimated using various statistical techniques. Some of them are internal consistency, interpreter reliability, and retesting.

The t-test is the most widely used method to evaluate the differences in the mean between groups. This test is the parametric test because they estimate parameters of some underlying normal distribution. The advantages of parametric tests are that they are more powerful and flexible methods that allow researchers to study the effect of many variables and their interaction. The research will use Independent T-Test when there are many instances that the researcher is interested to know whether two groups are different from each other on a particular interval-scaled of interest.

There are five (5) assumptions need to comply before performing this independent t-test, which are:

1. The examination of various data formats regarding test or dependent variables. The dependent variable needs to be represented by perpetual or quantitative data.
2. The sample is chosen at arbitrary from the target population. The sample chosen concerning the population must be chosen at random using any probability sampling methodology.
3. The measurements ought to be separate. This signifies that just one subgroup should include the sampling component. It shouldn't be compared to anything else or measured more than once.
4. The presumption of normality must be met. According to this presumption, the data distribution for each group must be normally distributed. Graphs like the 34 histogram, a normal Q-Q plot, or statistical tests like Shapiro-Wilk or Kolmogorov-Smirnov can be used to verify this claim. However, with a large sample size of more than 30, the deviance from this premise shouldn't have any significant negative effects.

5. The homogeneity assumption needs to be met. The homogeneity assumption must be met since both groups ought to bear an identical constant variance. Levene's test may be employed in order to verify this premise.

## **FINDINGS**

This study aims to investigate the relationship between destination choice and destination elements, including infrastructure, food, and services. The researcher has investigated the three criteria in further detail and has been able to determine the study's findings based on the analysis done in chapter 4. Questions from this research are divided into four sections: A, B, C, and D. The total number of respondents who answered the survey via Google Form makes up the sample size of the total 384 respondents. Researchers gathered the data and used SPSS (Statistical Package for the Social Sciences) to analyse it, including reliability testing, frequency analysis, descriptive analysis, and Pearson's correlation coefficient analysis to come to their final conclusions about the factors that influence travellers' decisions to visit Melaka. All of the variables that are the dependent variable (DV) and the independent variable (IV) collected a higher Cronbach's alpha scale value, which was 0.7 and above, according to the results of the reliability test of the pilot study. The food variable, which has the highest Cronbach's Alpha score of all these variables at 0.922, displays great results.

## **DISCUSSION AND RECOMMENDATION**

The research study was conducted to investigate the elements that influence travelers' decision to visit Melaka as a place to go on their holiday destination. The researcher investigated the connection throughout independent and dependent factors. The study was conducted has so much related with the development of the tourism industry throughout the Malaysia that researcher can identified. The scope of this study is in Melaka which the area in Malaysia, as mention Malaysia is the country is rich with the culture and diversity of food also Malaysia is one of the countries that are developing economically, politically and socially.

Suggestions in the present research that scholars may apply in future endeavors, such as cultural aspects in Melaka such as Dondang Sayang, Zapin, and Rebana Keras, or economic characteristics in Melaka such as their trade system, preferential tax system, and maritime regulations.

In this study researcher has recommend is the scope of respondents' contribution in the future to attract more tourists from Sabah and Sarawak because the frequency of those who answered the questionnaire from both states are less than half. Sabah and Sarawak is state in Malaysia which is separated from the Malaysian peninsula, which requires tourists from both states to spend more in terms of airplane transport because to go to Melaka you have to go through the South China sea route. With the research done will be a reference for potential tourists especially from Sabah and Sarawak to choose Melaka as a holiday destination

## **CONCLUSION**

Based on the replies from 384 respondents using the Google form, the researcher was able to effectively finish this study on the "Factors Influence Tourists' Selecting Melaka as Holiday Destination." In order to accomplish the research goal, the researcher had to identify the most pertinent variables, such as infrastructure, food, and destination aspects, that might affect why traveller choose Melaka as their vacation location. The study's purpose states that there are a number of issues that need to be addressed since a person or traveller still needs to make a series of decisions and take a number of actions before deciding on a destination.

## Reference

- Awu Isaac Oben (2021). Research Instrument: A Questionnaire and An Interview Guide Used to Investigate the Implementation of Higher Education Objectives and The Implementation of Higher Education Objectives and The Attainment of Cameroon's Vision 2035. *European Journal of Education Studies*, 8(7) 113-130
- Bhandari, P (2020). An introduction to Quantitative Research. From <https://www.scribbr.com/methodology/quantitative-research>
- Department of Statistics Malaysia Official Portal. (2021). Tourism dashboard domestic Tourism statistics. Retrieved from [https://www.dosm.gov.my/v1/index.php?r=column/cone&menu\\_id=aG0ybDVybU9TNzdKSVR5MllKVTlQdz09](https://www.dosm.gov.my/v1/index.php?r=column/cone&menu_id=aG0ybDVybU9TNzdKSVR5MllKVTlQdz09)
- Richards, G. (2002). Gastronomy: an essential ingredient in tourism production and Consumption [https://thesispublication.com/wpcontent/uploads/Greg\\_Richards\\_Tourism\\_and\\_Gastronomy\\_Routledge\\_BookFi](https://thesispublication.com/wpcontent/uploads/Greg_Richards_Tourism_and_Gastronomy_Routledge_BookFi).
- Klein and Muller (2019). Qualitative Research Submission to . *Project Management Journal*, 50(1) 4-6. <https://doi.org/10.1177/8756972818817625>
- Krejcie, R. V., & Morgan, D. W., (1970) Determining Sample Size for Research Activities. *Educational and Psychological Measurement*. Khoo, S. L., Samat, N., Badarulzaman, N., & Dawood, S. R. S. (2015). The promise and perils of The island city of GeorgeTown (Penang) as a creative city. *Urban Island Studies*, 1(1), 20-34. <http://islandstudiesjournal.org/files/UIS.2.pdf>
- Murphy, M. (2016). Population definitions for comparative surveys in education. Australian Council for Educational Research (ACER). [https://research.acer.edu.au/ar\\_misc/22](https://research.acer.edu.au/ar_misc/22)
- Nasir, M. N. M., Rahim, M. A., & Hassan, S. (2021). Proposing a research model of destination loyalty: The case of gastronomic tourism in Malaysia. *International Journal of Modern Trends in Business Research*, 4(18), 8-13.
- Norhisham, S., Bakar, M. F. A., Azlan, N. N. I. M., Apandi, S. N. D. I. Y., & Khalid, N. H. N. (2021). Overview of Methodology for Developing Expert System Based on Expert View for Quality of Urban Bus Services in Peninsular Malaysia. *International Journal of Academic Research in Business and Social Sciences*, 11(12), 910–918. <http://dx.doi.org/10.6007/IJARBSS/v11-i12/11829>
- Seetanah, B (2011). Assessing the Dynamic Economic Impact of Tourism for Island Economies. *Annals of Tourism Research*, 38, 291-308M <https://doi.org/10.1016/j.annals.2010.08.009>
- Stefan Gossling, Dagmar Land-Durlacher (2021). Tourist accommodation, climate change and Mitigation: An assessment for Austria. *Journal of Outdoor Recreation and Tourism*, 34 (8) 1-9. <https://doi.org/10.1016/j.jort.2021.100367>
- Wolf, E. (2002). Culinary tourism: A tasty economic proposition. Retrieved in June 25, 2007, from <http://www.culinarytourism.org>.

Zuhier Abbas Azzez (2021). The Impact of Destination Image on Tourist Behaviour : Karbala As A Case Study. *International Journal of Sustainable Development and Planning*, 7 (16)1287-1298. <https://scholar.archive.org/work/uftwxxp3mncglaklie67j6u3e4/access/wayback/>

Zuraini Zainal Abidin, Hamidah Abd. Latif, Nurhazieyah Affyqah Hazizy (2021). Tourist's Perception of Attractions Factors in Melaka. *Journal of Social Science and Humanities*, 6 (1) 31-42 eISSN 0128-2875

# Tourist Satisfaction Towards Local Heritage Food In Pulau Pinang

*Shazuani Binti Mohammad Zambri, Siti Azra Khairunnisa Binti Zaidi, Siti Azyanadhirah  
Binti Mohd Jailani, Siti Fatimatusahrah Binti Iliah, \*Hazyati Binti Hashim*

*Faculty of Hospitality, Tourism and Wellness, Universiti Malaysia Kelantan*

[h20a1754@siswa.umk.edu.my](mailto:h20a1754@siswa.umk.edu.my), [h20a1763@siswa.umk.edu.my](mailto:h20a1763@siswa.umk.edu.my), [h20a1764@siswa.umk.edu.my](mailto:h20a1764@siswa.umk.edu.my),  
[h20a1766@siswa.umk.edu.my](mailto:h20a1766@siswa.umk.edu.my), [hazyati@umk.edu.my](mailto:hazyati@umk.edu.my).

---

## ABSTRACT

The goal of this article is to determine tourist satisfaction with heritage food on Pulau Pinang. The primary study question to be investigated is the influence of tourist satisfaction on local heritage food. Based on the findings of the study, the researcher learned about tourist satisfaction with local heritage foods in Pulau Pinang. This study employs quantitative research with 390 questionnaire delivered to participants. Data was acquired via reaching out to participants via online survey through Google form and SPSS software was used to analyse the data received from the respondents. The implications and recommendations are also presented for future researchers who may perform similar studied in the near future.

**Keywords:** Heritage Food, Students, Tourist Satisfaction, Food Image, Destination Image, Service Quality

---

## INTRODUCTION

The first chapter discusses the background of the study of this research, the research question, and the research objective. After that, it is also addressed the scope and limitations of the study as well as its significance of the study. The topic of the research is tourist satisfaction towards the local heritage food in Pulau Pinang. Basically, local cuisines play a vital role in creating tourist destinations places, boosting tourism, and becoming one of the tourism product attractions. The purpose of this paper is to identify tourist satisfaction the intention on local food heritage at Pulau Pinang (Penang).

### Significance of the Study

This study may be used to better assess visitor acceptability of cultural foods in Pulau Pinang. The cuisine scene on Pulau Pinang is virtually legendary with many people travelling long distances merely to sample the island's exquisite treats. Local heritage food knowledge has piqued the interest of all generations of tourist visiting Pulau Pinang. Some organizations must study this subject and be able to take preventative action so that Malaysians and visitor do not forget about the native heritage food on Pulau Pinang.

This study will help an industry that holds research to criteria other than academic publications, namely financial returns. The diverse preferences of all generations regarding local heritage food in Pulau Pinang were also included. Local heritage food in Pulau Pinang face issues that threaten cultural and identity of their food. Exposing students to this research will provided them with a distinct viewpoint than simply presenting journal themes or working in academic publications.

## LITERATURE REVIEW

### Tourist Satisfaction

The concept of tourists satisfaction has been studied extensively in the context of tourism and hospitality sector (Nasir et al, 2022). Tourist satisfaction refers to the visitor's satisfaction with a product or service that meets their wants, intentions, and desires. It is influenced by pre- and post-travel expectations and experiences. Satisfaction is achieved when experiences exceed expectations, while disappointments is expected if unhappy. Two factors influence satisfaction, the expectations the visitor had before the trip and the tourist's defense of the services received after the trip. Swan and Combs (2012) assert that contentment is a post-purchase attitude.

Westbrook (2012) proposed that cognitive and emotive characteristics contribute to customer satisfaction during the pre-purchase, purchase, and post-purchase stages of acquiring products and services. Customer satisfaction is a judgment made after a service encounter and it is diverse and requires fresh perspectives across industries.

### **Food Image**

Pulau Pinang is renowned for its diverse cuisine and street food, including the best hawker food in Malaysia. Tourists can enjoy a variety of dishes, including *Char Koay Teow*, *Nasi Kandar*, *Pasembor* and *Laksa*. Pulau Pinang is recognized as the world's best food destination, surpassing other destinations like Bangkok and Paris. The selection of local food is influenced by nine motivational factors, including enjoyable experience, escape from routine, health awareness, knowledge, learning, authentic experience, togetherness, sensory stimulation and physical environment.

Local food selection among tourists is influenced by exploration of local culture, authentic travel experience, opportunities to learn and obtain information, status and prestige, influence from referred groups, and subjective perceptions. Food can provide a unique experience and pleasure to travel, making it one of the most memorable parts of a trip. Pulau Pinang street food is among the best in the world, offering affordable dishes from Chinese, Malay, Indian and Nyonya styles. The food of a destination can represent its image and special features.

### **Destination Image**

Pulau Pinang a popular destination in Asia, is known as a "food paradise" due to its diverse food offerings, including traditional heritage and western cuisine. The city is also known for its famous street food, which combines Malay, Chinese, Indian, Arabic, Siamese and European cuisine. Pulau Pinang's attractions include social interaction, natural environment, culture, lodging, transportation, infrastructure, food, friendly people, physical facilities, recreational activities, bars and nightlife.

Tourism Malaysia categorizes Pulau Pinang into various tourism categories, including cultural, adventure, beach, medical, agricultural and food tourism. Local heritage cuisine is considered an intangible destination, offering authentic cultural experiences for both domestic and international tourists. The image of food and food destinations in tourism is rapidly growing with the availability of cultural diversity increasing tourists' interest in visiting place. Local cuisine can add value to traditional tourism experiences, particularly for tourists seeking new experiences. As the image of food of food in the tourism industry develops, it contributes to the rapid development of destinations and regions for the tourism industry.

### **Service Quality**

Service is an activity or action performed by one party to another, resulting in mutual gain. It can be associated with tangible or intangible products. Service quality is a focused assessment that reflects a customer's perception of the service, including ability, assurance, empathy, responsiveness and tangibles. A key component for tourists is service quality, as they are concerned about the quality of shop service. A good, quick and well-treated shop attracts more customers, and clean food is essential for attracting them. Employers must also train staff to interact with visitors and provide high-quality service, ensuring customer satisfaction and future business growth.

## Research Hypothesis

The hypothesis in the study is to find out whether there are any correlations or relationship between dependent variables and independent variables:

- H1:** There is a significant relationship between food image and tourist satisfaction on local heritage food in Pulau Pinang.
- H2:** There is a significant relationship between destination image and tourist satisfaction on local heritage food in Pulau Pinang.
- H3:** There is a significant relationship between service quality and tourist satisfaction on local heritage food in Pulau Pinang.

## Research Framework

The literature review has prompted the development of a research framework that aims to investigate the satisfaction of tourist toward local heritage food in Malaysia's southern region of Pulau Pinang. A conceptual framework for the study has been created. The variables that are proposed for the research include the food image, the destination image, and the service quality of the local food.

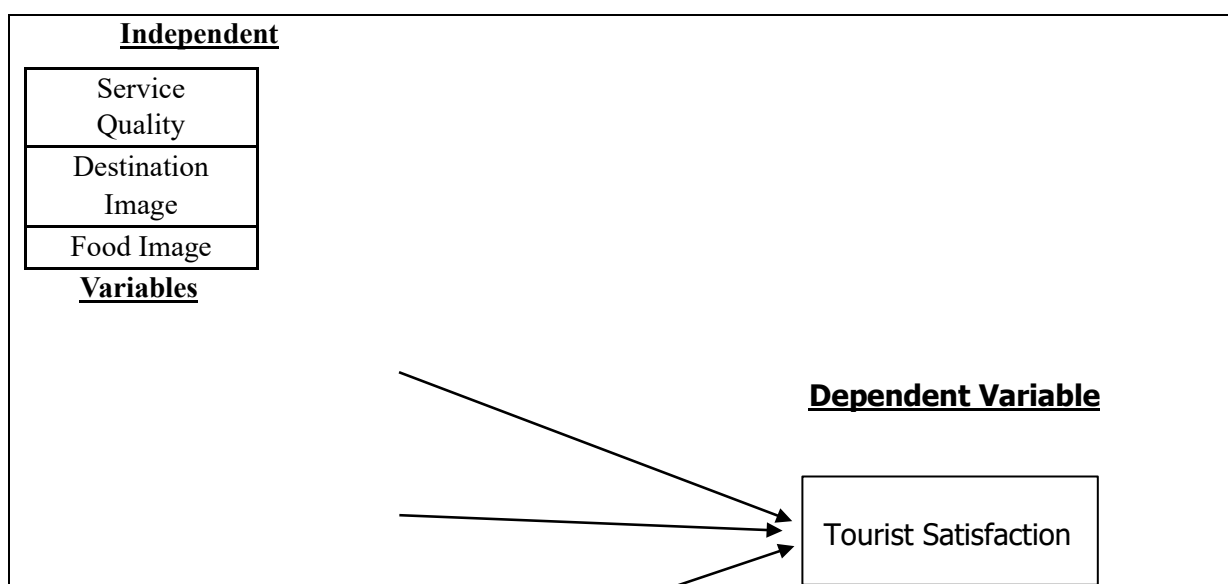

Figure 2.1: Conceptual Framework (Abdullah & Rahman, 2022)

## METHODOLOGY

### Research Design

The study's design incorporates the factors that impact consumer satisfaction with e-hailing businesses among Malaysian tourists. A quantitative technique will use in this study, and data will collect from individuals using a self-directed questionnaire. The relationship between food image, destination image and service quality towards local heritage food in Pulau Pinang. among Malaysian tourists is the subject of a descriptive study. The descriptive study design assists in answering the research questions and achieving the research objectives.



### **Data Collection**

Online surveys using Google Forms were the main data collection tool in the study's initial phase. The justifications for the researcher's usage of this set of technological resources is because it is free and friendly user. It also makes it easier to the researcher to collect all the data from local tourists. Fieldwork was the second stage of data collecting. This study, questionnaire also had been used as the instrument for primary data collection.

There have 6 parts of the section that respondents need to answer. The questionnaire was provided to individuals in Malaysian local tourist attractions for the purpose to collect data.

### **Sampling**

Sampling method chosen is stratified random sampling. Stratified random sampling is considered efficient, quick, and successful for gathering data in a sample. It involves dividing the population into smaller subpopulations or strata. Random samples are then selected from each stratum. The strata can be based on various classifications such as age, socioeconomic status, civic affiliation, religion, and educational achievement.

The questionnaire will be distributed through the web and directly to the targeted sample. Any incomplete or unreliable responses will be substituted with responses from other respondents. This helps ensure a comprehensive and reliable dataset for analysis.

### **Research Instrument**

To conduct this investigation, researchers created a questionnaire consisting of four parts to evaluate the validity of the generated hypotheses. The questions were meticulously crafted to align with the research study's topic. The table below provides a summary of the factors considered and supported to assess the food image, destination image, and service quality in relation to heritage food in Pulau Pinang.

Table 1: Measurement items

<b>Measurements</b>	<b>Number of items in the questionnaires</b>	<b>Scales used</b>	<b>Author</b>
Section A: Demographic information	5	Adapt	Tomic, Deronja, Kalit & Mesic (2018)

	5	Adapt	
Section B: Tourist satisfaction towards heritage food in Pulau pinang			Abdullah, Rahman (2022)
Section C 1 : <b>Food image towards heritage food in Pulau pinang</b>	5	Adopt	Abdullah, Rahman (2022)
Section C 2 : <b>Destination image towards heritage food in Pulau Pinang</b>	5	Adopt	Abdullah, Rahman (2022)
Section C 3 : <b>Service quality towards heritage food in Pulau Pinang</b>	5	Adopt	Abdullah, Rahman (2022)
Total	25		

### **Data Analysis**

In this section, the research data and statistical analysis findings are presented to achieve the study's objectives. The data analysis includes descriptive statistics, reliability tests, and Pearson correlation. The questionnaire data was organized, edited, and categorized using computer software like SPSS for accurate interpretation. The variables were analyzed, and descriptive analysis was used to describe respondents' biographical information. Reliability tests were conducted to assess the relationship between the variables in the study. The independent and dependent variables were analyzed, and the Pearson Correlation Coefficient was used, following the approach outlined by Bewick et al. (2003).

### **FINDINGS**

The study found that heritage food significantly influences food image, destination image, service quality, and tourist satisfaction in Penang. The findings of the study show that food image, destination image, service quality, and tourist satisfaction in Penang, are based on a survey of 384 respondents. The highest mean value for food image was found in question 1, with respondents stating that heritage food was well-known and reasonably priced on offer. The highest mean values for destination image were found in questions 1 and 4, with respondents indicating a trend of people buying heritage food. The lowest mean value was found in question 2, where respondents considered Penang as a good destination for food tourists. Service quality was highest in question 5, with respondents being satisfied with the service provided and praising the attractive atmosphere, lighting, and music decoration. The highest mean value for tourists' satisfaction with local

heritage food was found in question 5, with respondents expressing a desire to bring others to try the food and share their experiences.

## **DISCUSSION AND RECOMMENDATION**

On the side of overcoming the limitations stated in Chapter 5.5, some solutions can be proposed for potential researchers planning to perform a similar study. Firstly, the suggestion can be given for future researchers are to increase the research area which collect more data with various of tourism in another state in Malaysia such as Terengganu, Kedah and Pahang.

In the end, the researcher could prepare a multilingual version of the questionnaire to diversify it. Malay, English, and Mandarin are among the languages spoken in Malaysia, a multilingual nation. Respondents who are not strong in English may be confused by this study, which was conducted in only English. Therefore, it is recommended that future researchers get ready .To make it easier for the respondents and to ensure that the results are more accurate data, the questionnaire should be available in multiple languages.

In addition, the suggestion can be provided the future researchers is they can conducting interview sessions and focus groups because this might obtaining valuable and more reliable findings. Besides, many studies explored the tourist satisfaction toward local heritage based on affected media social. Therefore, the future researcher might be able to explore the tourist satisfaction based on product.

## **CONCLUSION**

In this chapter, the research project had fulfilled its objectives to investigate the tourist satisfaction on local food heritage. Study summary, discussion of major findings, and research implications have been discussed. In addition, some of the limitations of this study were set to remind future researchers. Conclusion of overall research was provided. Lastly, the suggestions for further research were provided.

## **REFERENCES**

- Akter, M., Sadekin, M. N., & Patwary, A. K. (2020). An Empirical Study on Students' Satisfaction from Mawlana Bhashani Science & Technology University, Bangladesh. *Review of Economics and Development Studies*, 6(2), 363-379.
- Al Mahmud, S. R. (2020). The effectiveness of Facebook advertisements on purchase intention of customers in Malaysia. *South Asian Journal of Social Sciences and Humanities*, 1(1), 97-104.
- Alom, S., Patwary, A. K., & Khan, M. M. H. (2019). Factors affecting the turnover intention of Bangladeshi migrants in the United Arab Emirates: An empirical study on the hotel industry. *International Journal of Innovation, Creativity and Change*, 8(3), 344-360.
- Assaker, G., & Hallak, R. (2013). Moderating effects of tourists' novelty-seeking tendencies on destination image, visitor satisfaction, and short- and long-term revisit intentions. *Journal of Travel Research*, 52(5)
- Bayih, B. E., & Singh, A. (2020, September 1). *Modeling domestic tourism: motivations, satisfaction and tourist behavioral intentions*. Heliyon; Elsevier BV. <https://doi.org/10.1016/j.heliyon.2020.e04839>

- Blackston M, Lebar E (2015) Constructing consumer-brand relationships to better market and build businesses. In: Fournier S, Breazeale M, Avery J (eds) Strong brands, strong relationships. Routledge, Abingdon, p 376
- Business Bliss FZE. (2023, January 16). *Definitions available for quantitative research given by different authors*. <https://www.ukessays.com/essays/psychology/definitionsavailable-for-quantitative-research-given-by-different-authors-psychology-essay.php>
- Business Bliss FZE. (2023a, January 16). *Definition of Service Quality*. <https://www.ukessays.com/essays/marketing/definition-of-service-quality-marketingessay.php>
- Etikan I. & Bala K. (2017). Sampling and sampling methods. *Biom Biostat Int J*. 2017;5(6):215-217. DOI: 10.15406/bbij.2017.05.00149
- Fengmin, Z., Baijun, W., Jiangtao, B., Li, L., & Patwary, A. K. (2022). Investigating revisit intention of medical tourists in China through nutritional knowledge, perceived medical quality, and trust in the physiologist: A recommendation on health tourism policy measures. *Frontiers in Public Health*, 10, 893497.
- Food and tourism destination image: Moderating effect of local food ... (n.d.). [https://www.researchgate.net/publication/323906160\\_Food\\_and\\_Tourism\\_Destination\\_Image\\_Moderating\\_Effect\\_of\\_Local\\_Food\\_Consumption\\_satisfaction/customersatisfactionmodels/84-customer-satisfaction](https://www.researchgate.net/publication/323906160_Food_and_Tourism_Destination_Image_Moderating_Effect_of_Local_Food_Consumption_satisfaction/customersatisfactionmodels/84-customer-satisfaction)
- Glossary of tourism terms* | UNWTO. (n.d.). <https://www.unwto.org/glossary-tourism-terms>
- Hanan, H., & Abd Hamid, Z. (2017). Perception of Kelantan Food Image among Tourists Visiting Kelantan. *Journal of Tourism, Hospitality & Culinary Arts (JTHCA)*, Vol. 9 (2)(October), 443–452.
- Hazbar, A. M. H., Alem Mohammed, A., & Karim, A. K. A. (2019). An Empirical Study of Factors Influencing hotel customers' online booking Intention. *مجلة العلوم التربوية و الدراسات الإنسانية*, (5), 1-17.
- Intan, S., Wong, N., & Lui, E. (2018). Satisfaction Drivers and Revisit Intention of. *Jurnal of Tourism, Hospitality and Environment Management*, 3(June), 1–13.
- Jackson. C. (2021). Convenience Sampling in Statistics: Definition & Limitations. Retrieved from <https://study.com/academy/lesson/convenience-sampling-definition-and-limitations.html>
- Journal of Destination Marketing & Management*, 9, 104
- Khasawneh, M. S., & Alfandi, A. M. (2019). Determining behaviour intentions from the overall destination image and risk perception. *Tourism and Hospitality Management*, 25(2), 355-375. <https://doi.org/10.20867/thm.25.2.6>
- Lehto, X. Y., O'Leary, J. T., & Morrison, A. M. (2004). The effects of prior experience on vacation behavior. *Annals of Tourism Research*, 31(4), 801-818. <https://doi.org/10.1016/j.annals.2004.02.006>
- Li, F., Wen, J., & Ying, T. (2018). The influence of crisis on tourists' perceived destination image and revisit intention: An exploratory study of Chinese tourists to North Korea.

- Li, L., Ragavan, N. A., Patwary, A. K., & Baijun, W. (2022). Measuring patients' satisfaction toward health tourism in Malaysia through hospital environment, nutritional advice, and perceived value: A study on Chinese exchange students. *Frontiers in public health*, 10, 893439.
- Li, L., Wu, B., & Patwary, A. K. (2022). How marine tourism promote financial development in sustainable economy: new evidences from South Asia and implications to future tourism students. *Environmental Science and Pollution Research*, 29, 1155-1172.
- Li, L., Wu, B., & Patwary, A. K. (2022). The psychosocial factors affecting chinese Outbound Exchange and mobility students' academic performance during COVID-19. *Frontiers in psychology*, 13, 872516.
- Nasir, M. N. M., Khan, N. F. A. H., Rasdi, A. L. M., Rahim, M. A., & Kamaruddin, M. (2022). The Parallel Mediators of Tourist Satisfaction and Place Attachment on Perceived Value and Destination Loyalty Relationship. *GeoJournal of Tourism and Geosites*, 45(4), 1618-1624.
- Patwary, A. K., Roy, B., Hoque, R., & Khandakar, M. S. A. (2019). Process of developing a community based tourism and identifying its economic and social impacts: An Empirical study on Cox's Bazar, Bangladesh. *Pakistan Journal of Humanities and Social Sciences*, 7(1), 1-13.
- Rousta, A., & Jamshidi, D. (2020). Food tourism value: Investigating the factors that influence tourists to revisit. *Journal of Vacation Marketing*, 26(1), 73-95. <https://doi.org/10.1177/1356766719858649>
- Sadeghi M, Zandieh D, Mohammadi M, Vaghoubibijarboneh B, Nasrolahi Vosta S (2017) Investigating the impact of service climate on intention to revisit a hotel: the mediating role of perceived service quality and relationship quality. *Int J Manag Sci Eng Manag* 12(1):12-20
- Sumethokula, P., Patwary, A. K., Srinuanpanc, B., Srinuanpand, C., Suwandee, P., Thammathikul, A., & Phanong, W. (2020). The potential of new tour repackaging for creative tourism among entrepreneurs in Nakhon Si Thammarat. *International Journal of Innovation, Creativity and Change*, 13(10), 1752-1771.
- Van Haaften, R. (n.d.). *Customer satisfaction*. [https://www.van-haaften.nl/customer-](https://www.van-haaften.nl/customer-FZE, B. B. (2023, March 21). Definition of service quality. UKEssays. https://www.ukessays.com/essays/marketing/definition-of-service-quality-marketing-essay.php)
- Wu, B., Liu, S., Wang, J., Tahir, S., & Patwary, A. K. (2021). Assessing the mechanism of energy efficiency and energy poverty alleviation based on environmental regulation policy measures. *Environmental Science and Pollution Research*, 28, 40858-40870.
- Wu, B., Zhai, B., Mu, H., Peng, X., Wang, C., & Patwary, A. K. (2021). Evaluating an economic application of renewable generated hydrogen: A way forward for green economic performance and policy measures. *Environmental Science and Pollution Research*, 1-15.

# THE FACTORS THAT AFFECT CUSTOMER SATISFACTION ON THE QUALITY OF HOTEL SERVICE

*Siti Maryam Hanah binti Abd Kadir, Siti Najihah binti Shamsudin, Siti Najwa Ashikin binti Shamsuddin, Siti Nazifah Anisa binti Md Nasir & Hazzlyati binti Hashim*

*Faculty of Hospitality, Tourism and Wellness, Universiti Malaysia Kelantan*

*Corresponding email:*

[h20a1771@siswa.umk.edu.my](mailto:h20a1771@siswa.umk.edu.my), [h20a1776@siswa.umk.edu.my](mailto:h20a1776@siswa.umk.edu.my), [h20a1777@siswa.umk.edu.my](mailto:h20a1777@siswa.umk.edu.my),  
[h20a1778@siswa.umk.edu.my](mailto:h20a1778@siswa.umk.edu.my), [hazzlyati@umk.edu.my](mailto:hazzlyati@umk.edu.my)

---

## ABSTRACT

The objective of this research is to look into the relationship between service quality and customer satisfaction in Malacca hotels by using SERQUAL analysis. It also aims to explore the influence and outcome of providing quality service on customers satisfaction, as well as to determine which SERVQUAL dimensions of tangibility, assurance and reliability have been identified as independent variables while customer satisfaction has been in dependent variable. Each dimension was tested in order to determine and quantify the relationship with customer satisfaction. Customers who had stayed in Malacca hotels completed the questionnaires. A total of several respondents participated in the survey. The findings of the research show that the service quality provided by the hotels can affect customer's satisfaction.

**Keywords: service quality, tangibility, assurance, reliability, customer's satisfaction**

---

## INTRODUCTION

The global market trend has turns dramatically from agricultural to service sectors (Asian Development Outlook, 2007). All service industries especially the hotel industry, are making effort to improve the quality of their offerings in order to satisfy customers. Hoteliers are currently emphasising quality in order to reach their guests' basic needs and assumptions. Parasuraman et al. (1985) concluded service quality as the contrasts between performance and assumption in major parameters. Another way to describe service quality is as an ascertain of how well an organisation meets the essentials and expectations of its customers.

The hotel sector contributes significantly to Malaysia's economic growth. Due to a hotel's primary service offering, it is important for hoteliers to place an emphasis on customer happiness with service quality and the avoidance of low customer satisfaction in order to preserve the hotel's reputation. Aiming to provide a quality of service that meets or exceeds customer expectations. Therefore, the purpose of this study is to ascertain how several critical aspects of hotel management interact and what impact that has on both service quality and guest satisfaction. The findings demonstrated that accommodations had a favourable impact on the level of service provided by hotels in Malacca.

There are research objectives of our study:

1. To examine the relationship between tangibility and customer satisfaction.
2. To examine the relationship between assurance and customer satisfaction.
3. To examine the relationship between reliability and customer satisfaction

## **Significance Of The Study**

The finding of the study will benefit the future researcher, the community as a guide to do their research in the same field. The outcome of this study is to determine the relationship between Tangibility, Assurance and Reliability toward customer's satisfaction. There are many factors that will influence a person's level of satisfaction with a service, for example, service quality in a holiday destination such as a hotel. As we know, the place to stay when we are on vacation is one of the most important aspects to create a sense of satisfaction throughout the vacation.

Customers' levels of satisfaction will vary because each person will have a unique experience based on the location they visit. Various factors will also influence the level of customer satisfaction, so every service provided must be compatible and appropriate with the customer in order to leave a positive impression on them after their stay at the hotel is over. As a result, in this study, researcher will look at all the factors that customers may accept if they visit the hotel, and we will be able to provide feedback to the hotel industry if the level of service provided has deficiencies so that they can improve in the future. If the situation improves, the number of customers who visit Malacca's hotels will increase, as will the hotel industry's profit growth.

## **LITERATURE REVIEW**

### **Customer Satisfaction**

In the context of hospitality and tourism, the concept of satisfaction has been studied extensively (Nasir et al, 2022). Customer satisfaction is always regarded as a major issue in a highly competitive market that should be carefully considered by every company, particularly those in the service industries, because it is critical to improve service quality and maintain client loyalty. (Awwad, 2012; Alhkami & Alarussi, 2016). According to Wang'ombe and Ngige (2016), customer satisfaction is viewed as an indicator in the hotel industry that determines whether visitors are likely to go over and revisits to a specific hotel, regardless of whether they have a satisfied or dissatisfied service. According to Eshetic et al. (2016), hoteliers can measure their service quality to decide whether customers are satisfied or dissatisfied with the overall level of services.

### **Tangibility**

The appearance of physical factors such as the facilities provided by a service firm is defined as the tangibility of service quality. It also refers to how a service provider presents themselves to potential customers. (Alhkami & Alarussi, 2016. Modern-looking room features and the availability of popular television channels are just a few examples of the well-maintained facilities that hoteliers must offer in order to attract potential visitors. According to Eshetic, Seyoum, and Ali (2016), tangibility exists a discrepancy between customer perceptions and expectations that is detrimental to overall customer satisfaction as well as experiences.

### **Assurance**

According to Francis (2012), assurance appoints to the ability of service providers to inspire potential customers with a sense of trust and confidence when serving service. Customer happiness can be significantly impacted by assurance; thus, hoteliers must continuously focus on this aspect to comprehend the demands and wants of their guests (Tuan & Linh, 2014). Every service provider in the hotel sector should be knowledgeable in a variety of areas to boost total customer satisfaction, including the capacity to make guests feel safe while staying at the hotel, a wide range of essential knowledge about hotels, and a pleasant service attitude (Ahmad et al., 2018).

### **Reliability**

The ability of a service provider to provide the best services within the time promised is referred to as service quality reliability (Bhawarna, Bashir & Mohsin, 2013). The hotel policies must then be strengthened so that service contributors can consistently deliver on their promises to potential guests while they are staying at the accommodation provided (Wang'ombe & Ngige, 2016). Customers are more likely to give a high perceived service quality if service providers can provide accurate information that meets their needs, which profits the overall impression of the hotel services (Gunarathne, 2014).

### Research Hypothesis

In this study, there were three hypotheses tested are:

**H1:** There is a relationship between tangibility and customer satisfaction.

**H2:** There is a relationship between assurance and customer satisfaction.

**H3:** There is a relationship between reliability and customer satisfaction.

### RESEARCH FRAMEWORK

The research model used for this study is to investigate the factors that affect customer satisfaction on the quality of hotel service. Tangibility, assurance, and reliability are the independent variables and the dependent variable is customers satisfaction on the quality of hotel service.

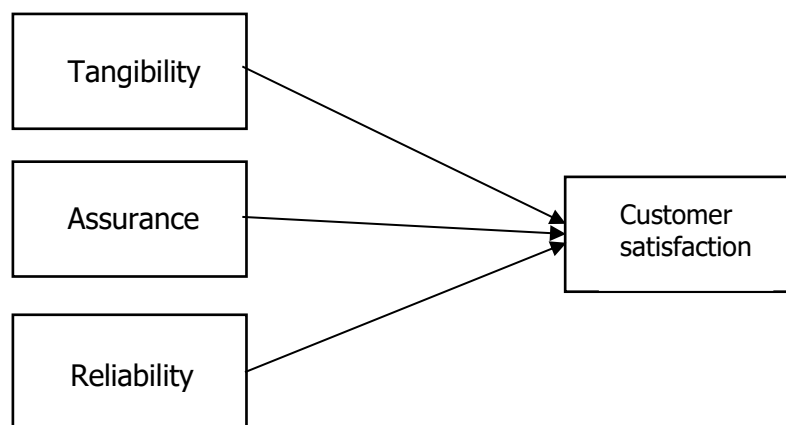

### METHODOLOGY

#### Research Design

The quantitative methods used in this study to gain the data from respondents with questionnaire via Google Form. The questionnaire was created in two languages which are English and Malay to make sure respondents understand the question. This study wants to find the relationship between the factors affect customer satisfaction on the quality of hotel service. The questionnaire is having 2 section, Section A is Demography which is having 5 items while for Section B is about the variables which got 20 items. There have a 5point Likert with closed-ended questionnaire scales ranging from (1) "Strongly Disagree" to (5) "Strongly Agree" used in measuring all the variables.



## Data Collection

Firstly, the researcher conducted the pilot test with 35 respondents to test the reliability. A set of questionnaires was spread to respondents in order to collect data through the social media platform. Customers who stayed at a three-star hotel in Malacca filled out questionnaires. A questionnaire may be distributed to hotel guests following the check-out process so that the researcher can obtain a response as soon as possible or random asking them to those who in rushing.

## Sampling

The non- probability sampling used in this study and known as convenience sampling. Convenience sampling entails choosing participants who are frequently ready and available. It appears to be a popular student sampling technique because it is less expensive and easier to use than other sampling techniques (Ackoff, 1953).

## Data Analysis

The latest version of the statistical package for social sciences (SPSS) was used to analyse all data collected via the self-administered questionnaire, and the necessary measures were implemented. SPSS is one of the perfect programmes for conducting data analysis (Raduzzi & Massey, 2019).

## FINDINGS

### Demographic Profile

Variables	Frequency	Percentage (%)
<b>Gender</b>		
Male	130	33.8
Female	255	66.2
<b>Age</b>		
16-40	142	36.9
41-50	29	7.5
51	12	3.1
< 25	202	52.5
<b>Race</b>		
Malay	266	69.1
Chinese	66	17.1
Indian	46	11.9
Others	7	1.8
<b>Length of Stay</b>		
1 night	118	30.6
2 nights	209	54.3
More than 2 nights	58	30.6
<b>Frequency visit</b>		
Once a year	201	52.2
Once every 6 months	184	44.8
<b>Total</b>	<b>385</b>	<b>100.0</b>

Based on the figure above, 66.2% of the respondents were females and 33.8% of them are males. Next, 142 respondents {36.9%} were aged between 26 until 40 years old. Followed by 29 respondents {7.5%} aged 41 until 50 years old. Also, 12 respondents {3.1%} aged at 51 years old. And 202 respondents {52.5%} were aged below 25 years old in total. The result also was dominated by Malays

with 266 respondents (69.1%) followed by Chinese with 66 respondents (17.1%). Also, Indians have 46 respondents (11.9%) and lastly the other race has 7 respondents (1.8%). For more than two nights there are 58 respondents (15.1%). But for one night there were 118 respondents (30.6%). And most of the respondents stayed two nights at the hotel with 209 respondents (54.3%). Lastly, there were 201 respondents (52.2%) who stay at the hotel once a year. Also, 184 respondents (47.8%) stayed at the hotel once every six months.

### Reliability Test

Variables	N of Items	Cronbach's Alpha Value	N
Tangibility	5	.967	385
Assurance	5	.973	385
Reliability	5	.970	385
Customer's satisfaction	5	.980	385

The reliability results are displayed in the table presented above. The survey included three independent variables (tangibility, assurance, and reliability) and one dependent variable (customer's satisfaction toward service quality). The independent variable encompassed 15 questions, while the dependent variable involved 5 questions as designed by the researcher.

All the variables show an excellent level according to the Cronbach's Alpha Coefficient which is above 0.9. The Alpha values for all variables, as shown in the table above, indicate high reliability of the questionnaire instrument and internal consistency of the five-point Likert-type scales. The Alpha values obtained for variables demonstrate the high reliability of the questionnaire instrument and the internal consistency of the five-point Likert-type scales. It is strongly advised that in any perception study, the instrument's reliability and consistency should be assessed to ensure the reliability of the study's findings.

### FINDINGS

The table below shows the results of Pearson's correlation coefficient analysis ( $r$ ) for tangibility, assurance, and reliability (independent variables) as well as customer satisfaction (dependent variable). Based on the table, tangibility and customer satisfaction in the hotel industry shows a correlation of  $r = 0.853$  ( $p < 0.01$ ), while the correlation between assurance and customer satisfaction shows  $r = 0.892$  ( $p < 0.01$ ), and the correlation of reliability with customer satisfaction in the hotel industry was recorded at  $r = 0.886$  ( $p < 0.01$ ). Additionally, all the variables have a significance value of 0.000, which means that the hypotheses developed in the study are highly accepted. Based on the rule of thumb for correlation coefficient size outlined by Hair, Celsi, Money, Samouel & Page (2016), tangibility (0.853), assurance (0.892) and reliability (0.886) are all categorized within the moderate coefficient range.

Hypothesis	Result
------------	--------

H1: There is significant relation between tangibility and customer satisfaction.	Correlation Coefficient=0.889 P= 0.000	Accepted
H2: There is significant relation between assurance and customer satisfaction.	Correlation Coefficient=0.836 P= 0.000	Accepted
H3: There is significant relation between reliability and customer satisfaction.	Correlation Coefficient=0.853 P= 0.000	Accepted

## DISCUSSION AND RECOMMENDATION

Customer satisfaction is defined as a metric that determines how satisfied customers are with the service provided by a company. Besides, Customer satisfaction surveys and ratings can help a company determine the best ways to improve or change its products and services (ASQ, 2023). Similar to other studies, the current study is also not without several limitations that make it harder for the researchers to complete the investigation. The first limitation is that this research just focuses on the hotels in area Malacca However, researchers just are not focusing the respondent to respond to the questionnaire in area Malacca. But anyone that has experience stayed in a hotel in Malacca

Another limitation is by using quantitative method respondents tied to the available Likert scale. Actually, it is an easy task, but still difficult to reach during the data collection process. Some of the respondents would either ignore the survey link or misidentify the link as spam; some might have also thought that answering surveys is a waste of time.

### Recommendation

There are few recommendations that should be taken into consideration for improving the research. First recommendation is to expand the study area from one state to another. In this study, the study area only covers the audience in Malacca state. Future study can be improved by expanding the area of study so that the study can reach a wider audience and cover a bigger sample size. Research should be conducted not only in Malacca but also other states that have high tourism.

Second recommendation is to use a qualitative method to observe more about satisfaction from the tourist that visits the hotel. Rather than using quantitative methods in surveys, qualitative methods should be used to obtain more thorough and detailed data. Moreover, an in-depth analysis can be made and the research result will be from the participant's perspective rather than the investigator's perspective and interpretation.

## CONCLUSION

As the conclusion, this research study is happened to identity the factors that affect customer satisfaction on the quality of hotel service. This study helps to provide the hotels manager owner aiming to provide a quality of service that meets or exceeds customer expectations. This could be indicated that there is a directly proportional relationship between service quality and customer satisfaction. This hints that high quality services will lead to first-rate customer satisfaction. similarly, low quality services cause low satisfaction or dissatisfaction. Thus, it is hoped that all of the information provided throughout the research will help the upcoming researchers, students and public in good way.

## References

- Akter, M., Sadekin, M. N., & Patwary, A. K. (2020). An Empirical Study on Students' Satisfaction from Mawlana Bhashani Science & Technology University, Bangladesh. *Review of Economics and Development Studies*, 6(2), 363-379.
- Alom, S., Patwary, A. K., & Khan, M. M. H. (2019). Factors affecting the turnover intention of Bangladeshi migrants in the United Arab Emirates: An empirical study on the hotel industry. *International Journal of Innovation, Creativity and Change*, 8(3), 344-360.
- ASQ. (2019). *What is Customer Satisfaction?* Asq.org. <https://asq.org/quality-resources/customer-satisfaction>
- Awara, N., & Anyadighibe, J.A. (2014). The Relationship Between Customer Satisfaction and Loyalty: A Study of selected eateries in Calabar, *Cross Interdisciplinary Journal of Contemporary Research In Business*, 5, 110-125.
- Barsky, J. D. (1992). Customer Satisfaction in the Hotel Industry. *Hospitality Research Journal*, 16(1), 51–73. <https://doi.org/10.1177/109634809201600105>
- Business Insights - Blog. <https://online.hbs.edu/blog/post/descriptive-analytics> Elegba, E.O. & Adah, P.D. (2015). *Satisfaction*. Unpublished Thesis, The Federal
- Cote, C. (2021, November 9). *What Is Descriptive Analytics? 5 Examples | HBS Online*.
- Fengmin, Z., Baijun, W., Jiangtao, B., Li, L., & Patwary, A. K. (2022). Investigating revisit intention of medical tourists in China through nutritional knowledge, perceived medical quality, and trust in the physiologist: A recommendation on health tourism policy measures. *Frontiers in Public Health*, 10, 893497.
- Guru99.com. <https://www.guru99.com/what-is-data-analysis.html>
- Hazbar, A. M. H., Alem Mohammed, A., & Karim, A. K. A. (2019). An Empirical Study of Factors Influencing hotel customers' online booking Intention. *مجلة العلوم التربوية و الدراسات الإنسانية*, (5), 1-17.
- Indeed Editorial Team. (2021, March 11). *Service Quality: Definition, Importance and Implementation*. Indeed Career Guide. <https://www.indeed.com/career-advice/career-development/service-quality>
- Johnson, D. (2019). *What is Data Analysis? Types, Process, Methods, Techniques*.
- Kagan, J. (2021, October 20). *What You Should Know About Assurance*. Investopedia. <https://www.investopedia.com/terms/a/assurance.asp>
- Kelley, K. (2020, May 27). *What is Data Analysis? Process, Methods, and Types Explained*. Simplilearn.com. <https://www.simplilearn.com/data-analysis-methods-process-types->

- Laerd Statistics. (2018). *Pearson Product-Moment Correlation*. Laerd.com. <https://statistics.laerd.com/statistical-guides/pearson-correlation-coefficient-statistical-guide.php>
- Li, L., Ragavan, N. A., Patwary, A. K., & Baijun, W. (2022). Measuring patients' satisfaction toward health tourism in Malaysia through hospital environment, nutritional advice, and perceived value: A study on Chinese exchange students. *Frontiers in public health*, 10, 893439.
- Li, L., Wu, B., & Patwary, A. K. (2022). How marine tourism promote financial development in sustainable economy: new evidences from South Asia and implications to future tourism students. *Environmental Science and Pollution Research*, 29, 1155-1172.
- Li, L., Wu, B., & Patwary, A. K. (2022). The psychosocial factors affecting chinese Outbound Exchange and mobility students' academic performance during COVID-19. *Frontiers in psychology*, 13, 872516.
- Martyn Shuttleworth. (2019). *Definition of Reliability*. Explorable.com. <https://explorable.com/definition-of-reliability>
- Mutinda, J. M. (2020). *The Effect of service quality on customer satisfaction among hotels in Nairobi County, Kenya*. Su-Plus.strathmore.edu. <https://su-plus.strathmore.edu/handle/11071/10183>
- Nasir, M. N. M., Khan, N. F. A. H., Rasdi, A. L. M., Rahim, M. A., & Kamaruddin, M. (2022). The Parallel Mediators of Tourist Satisfaction and Place Attachment on Perceived Value and Destination Loyalty Relationship. *GeoJournal of Tourism and Geosites*, 45(4), 1618-1624.
- PANDA, T. K., & DAS, S. (2014, November 1). (PDF) *The Role of Tangibility in Service Quality and its Impact on External Customer Satisfaction: A Comparative Study of Hospital and Hospitality Sectors*. ResearchGate. [https://www.researchgate.net/publication/350312888\\_The\\_Role\\_of\\_Tangibility\\_in\\_Service\\_Quality\\_and\\_its\\_Impact\\_on\\_External\\_Customer\\_Satisfaction\\_A\\_Comparative\\_Study\\_of\\_Hospital\\_and\\_Hospitality\\_Sectors](https://www.researchgate.net/publication/350312888_The_Role_of_Tangibility_in_Service_Quality_and_its_Impact_on_External_Customer_Satisfaction_A_Comparative_Study_of_Hospital_and_Hospitality_Sectors)
- Patwary, A. K., Roy, B., Hoque, R., & Khandakar, M. S. A. (2019). Process of developing a community based tourism and identifying its economic and social impacts: An Empirical study on Cox's Bazar, Bangladesh. *Pakistan Journal of Humanities and Social Sciences*, 7(1), 1-13. Polytechnic, Idah, Kogi State.
- Rahman, S.M., Khan, H.A. & Haque, M.M. (2014). A conceptual study on the relationship between service quality towards customer satisfaction: Servqual and Gronroos's service quality model perspective. *Canadian Centre of Science and Education*, 08, 201–210
- Sumethokula, P., Patwary, A. K., Srinuanpanc, B., Srinuanpand, C., Suwandee, P., Thammathikul, A., & Phanong, W. (2020). The potential of new tour repackaging for creative tourism among entrepreneurs in Nakhon Si Thammarat. *International Journal of Innovation, Creativity and Change*, 13(10), 1752-1771.
- Wu, B., Liu, S., Wang, J., Tahir, S., & Patwary, A. K. (2021). Assessing the mechanism of energy efficiency and energy poverty alleviation based on environmental regulation policy measures. *Environmental Science and Pollution Research*, 28, 40858-40870.
- Wu, B., Zhai, B., Mu, H., Peng, X., Wang, C., & Patwary, A. K. (2021). Evaluating an economic application of renewable generated hydrogen: A way forward for green economic performance and policy measures. *Environmental Science and Pollution Research*, 1-15.

# THE FACTORS OF SELECTING LANGKAWI ISLAND AS A TOURIST DESTINATION: A CONCEPTUAL PAPER

Siti Noorihan Binti Razali ,Siti Nor Masidayu Binti Mohd Jamil, Siti Nor Sabrina Binti Abd Rahim, Siti Norfatimah Binti Ibrahim,&\*Hazzvati Binti Hashim

*Faculty of Hospitality, Tourism, Wellness, Universiti Malaysia Kelantan*

[h20a1780@siswa.umk.edu.my](mailto:h20a1780@siswa.umk.edu.my), [h20a1783@siswa.umk.edu.my](mailto:h20a1783@siswa.umk.edu.my), [h20a1784@siswa.umk.edu.my](mailto:h20a1784@siswa.umk.edu.my),

[h20a1788@siswa.umk.edu.my](mailto:h20a1788@siswa.umk.edu.my), [hazzvati@umk.edu.my](mailto:hazzvati@umk.edu.my)

## ABSTRACT

Previously tourism researchers have identified the factors that influence the decision for selecting Langkawi Island as a tourist destination. The relationships between factors affecting destination selection have not been extensively studied, particularly in the context of Langkawi Island, although current research suggests a strong association between them. This research intends to examine a factor of destination selection among tourists on Langkawi Island. In addition, it was observed in the literature that there is still insufficient empirical data in explaining the factor of destination selection among tourists in Langkawi Island. The respondents to this study will be visitors who travelled to Langkawi Island. The statistical program IBM SPSS version 26 will be utilized in evaluating 384 samples of data. This study will extend the knowledge of factors of destination selection among tourists interested in this research the article in general in Langkawi Island, Malaysia.

**Keywords:** *destination selection, economic, infrastructure, and attraction.*

## INTRODUCTION

The tourism sector offers various services and tourism products for tourists' needs on vacation, business, and other related tourism characterized travel trips (Nasir and Wongchestha, 2022). Tourism can be defined as visiting relatively unspoiled natural areas with the goal of acquiring knowledge, appreciating, and enjoying the environment and its wild flora and fauna, along with other remaining cultural and historical components. Amongst those are archaeological and historical monuments, sanctuaries, parks, hill resorts and clubs, and sea beaches, to list a few. This is a multi-sector industry that covers travel, accommodation, eating and drinking establishments, retail shops, entertainment establishments, activities, facilities, and other hospitality services provided to individuals or groups traveling away from home (Bhargava, 2009). Langkawi Island, Malaysia has evolved significantly since former Prime Minister Tun Mahathir Mohamed first visited in 1981. Several attempts have been made to develop the island, but have been unsuccessful. To benefit and expand the economy, changes and effective visitor-attracting techniques must be undertaken.

Destination selection is an important problem for service providers to handle, especially given the severe competition and clients' increased knowledge as a result of technology and the internet. This study on Langkawi Island's Destination Selection piqued our interest. Langkawi Island is a popular tourist destination in Malaysia that attracts millions of visitors every year. However, despite its popularity, there may be several factors that influence the decision-making process of tourists when selecting Langkawi Island as their destination of choice. Identifying these factors is crucial for the local tourism industry to develop effective marketing strategies and improve the overall tourism experience for visitors. Therefore, the problem statement is: What are the key variables that impact travellers' decisions to visit Langkawi Island, and how can these factors be used to strengthen the island's tourism industry?

The objective of this research are:

1. To examine the relationship between economy factors towards tourism industry in Langkawi as Destination Selection.
2. To examine the relationship between infrastructure factors towards tourism industry in Langkawi as Destination Selection.
3. To examine the relationship between attraction factors towards tourism industry in Langkawi as Destination Selection.

## LITERATURE REVIEW

### **Destination Selecting**

The factors of selecting Langkawi Island as a tourist destination. These include evaluating the location from the visitors' point of view, which includes their age and gender, family and socioeconomic status, the scope of the domicile location, and financial and physical well-being, as well as cultural, economic, and political developments, climate, and being accessible of attractions (such as cultural events, monuments, and festivals). After extensive study into this study, several characteristics have been found as explanatory variables for travellers' destination selections. These variables are roughly classified into two categories: environmental factors such as marketing data and destination features, and individual trait factors such as personal attributes and social-demographic profiles, among others. Cultural elements can significantly influence travellers' choice of destinations by influencing their social and demographic backgrounds, psychological characteristics, and choice of locations.

### **Economy**

The first consideration is the expense of travel. This covers the cost of travel, lodging, food, and Langkawi activities. The cost of flight can be a crucial issue in deciding whether or not to visit Langkawi, since it can account for a large amount of total trip expenditures. The cost of lodging might also influence a tourist's decision to visit Langkawi. Tourists may be more inclined to visit if they can find inexpensive and pleasant lodgings, such as hotels, resorts, or vacation rentals, that meet their demands. The availability of a diverse variety of lodging alternatives may also play a role in the decision to travel. The cost of food can also influence the decision to visit Langkawi, as dining out can be a significant expense for tourists. The cost of activities and attractions can also be a factor in the decision to visit Langkawi.

### **Infrastructure**

Tourists can decide on the Langkawi Islands as a destination because they believe the infrastructure will suit their demands and deliver a great and joyful travel experience. For example, if visitors believe the transit system is dependable, they are more likely to visit additional destinations and attractions during their stay. Additionally, if guests perceive the lodgings to be pleasant and clean, they are more inclined to return or suggest Langkawi Islands to friends. There are several factors that influence infrastructure in Langkawi Island as a vacation choice.

Transportation infrastructure plays an important role in the selection of Langkawi Islands as a tourist destination. This infrastructure includes all of the facilities and services that allow tourists to move around the islands conveniently, safely, and efficiently. The quality and availability of lodgings can influence a tourist's decision to visit, as well as their overall pleasure with their vacation. Langkawi Islands include a variety of lodgings to accommodate a variety of budgets, interests, and vacation types. There are luxury resorts, boutique hotels, cheap guesthouses, homestays, and serviced apartments to choose from.

## **Attraction**

Attraction is one of the most important elements influencing tourism destination selecting and Langkawi Island offers several attractions that can entice tourists to choose it as their travel destination. Some of the elements contribute to Langkawi Island's popularity as a tourist destination. The first consideration is natural beauty. Langkawi Island is esteemed for its beautiful beaches, clear blue oceans, lush green jungles, and picturesque mountains. These natural features offer a calm and attractive setting that appeals to travellers looking for peace and leisure. The natural splendour of Langkawi Island creates a quiet and attractive setting that draws people looking to relax and reconnect with nature.

## **Research Hypotheses**

The study's hypothesis is to analyse whether there is an important relationship between the factor that is dependent and the independent variables. Numerous industry pursuits have made Langkawi Island famous. In attraction, tourism has a commercial centre to attract tourists for shopping, as well as superior amenities and infrastructure. Natural attractions, such as national parks, marine parks, and waterfalls, are sites that have natural environment appeal.

H1. There is relationship between economy factors towards tourism industry in Langkawi.

H2. There is relationship between infrastructure factors towards tourism industry in Langkawi.

H3. There is relationship between attraction factors towards tourism industry in Langkawi.



## Research Framework

The research's framework was described in the graphic, which comprised both independent and dependent variables. This study's independent variables include the economy, infrastructure, and attractiveness. Meanwhile, the destination selection is the dependent variable.

### Independent Variables

### Dependent Variable

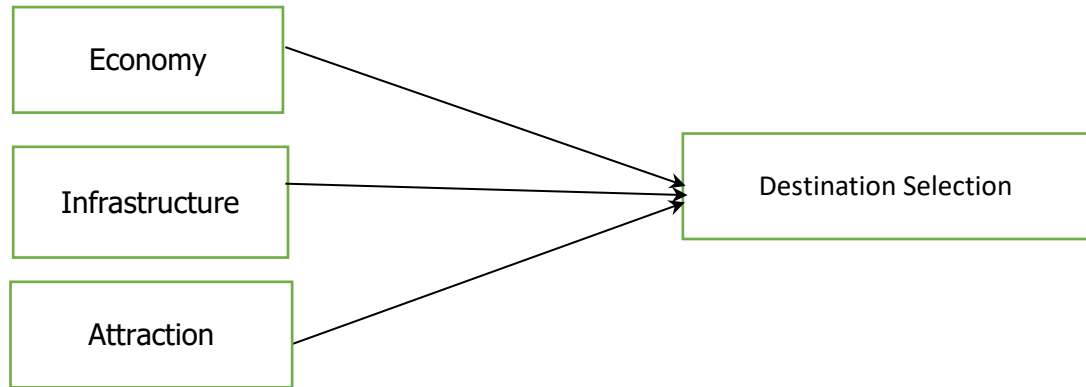

Figure 1: Conceptual Framework of the relationship between economy, infrastructure, attraction and destination selection.

## METHODOLOGY

### Research Design

In this study, quantitative research design had been used. Quantitative research reviews phenomena through accurate measurements in a systematic and controlled manner (Rutberg & Bouikidis, 2018). In this study, quantitative analysis can be applied because this study wants to obtain the data about the factors of selecting Langkawi Island as tourist destination selection.

### Population And Sample Size

The statistic of 2.5 million visits to Langkawi in 2022. Langkawi has recently acquired over 200,000 visitors per month and is on track to meet its target of 2.5 million inbound travelers by the end of the year. The population of the research in this study was placed in North Malaysia, whereas the sample was on Langkawi Island, Kedah. The researcher conducts this study using the stratified sampling technique. The stratified random sample is used to begin examining disparities between groups depending on race, gender, or educational attainment. You want to make a conclusion on the population as a whole. There are tourists in this population.

According to (Tabachnick, Fidell, & Osterlind, 2001), A sample size of 50 cases is regarded extremely small, 300 instances is considered decent, and 1000 cases or more is considered exceptional. The process of determining sample size for a finite population can be simplified. In this study, Krenjcie and Morgan's table was used as a reference. The required sample size for a population ranging from 500,000 to 749,999 is 384, according to (Krejcie & Morgan, 1970).

## **Data Collection**

This study's data will be collected by stratified sampling. Stratified sampling frequently involves segmenting a population into subpopulations with potentially drastically differing characteristics. It is easier to derive more accurate findings if each subgroup is fairly represented in the sample. Visitors to Langkawi Island will be given certain questions that the researchers have prepared. Researcher collects data when they read and observe things, then write down the information they discover.

## **Sampling**

The researcher has used convenience sampling in this case. The sampling technique consists of two methods: probability sampling, which includes stratified, simple, and cluster sampling. Non-probability sampling includes quota, convenience, and judgemental sampling. The purpose of the research was achieved using both probability sampling and non-probability sampling, with convenience sampling being the most often employed method. The targeted respondents were chosen via stratified sampling, which represented them proportionately to the population.

## **Research Instrument**

The questionnaire had been created for a pilot test with domestic tourists. There were three portions designed: sections A, B, and C. The researcher was asked questions on demographic information in section A. Section B discussed questions regarding three independent variables which is economy, infrastructure, and attraction. portion C, the final portion, asks questions about the dependent variable, which is destination selection.

The study's instruments, for example, were adapted and modified from previous studies. Five-point ranking scales were used for these topics, with 1 indicating strongly disagree, 2 indicating disagree, 3 indicating neutral, 4 indicating agree, and 5 indicating strongly agree.

Overall, 100 surveys will be sent to visitors on Langkawi Island as part of their destination selection, and the research recommends employing 100 respondents to establish the link between economic, infrastructure, attraction, and destination selection.

## Data Analysis

The Cronbach Alpha values in this investigation were examined using IBM SPSS version 25 software. IBM SPSS is an ideal initiative for this study since it gives versatility in managing and solving basic and complicated issues. As a result, employing this software to do reliability analysis in this study is beneficial to researchers. Cronbach's alpha will be used to analyse the internal consistency of the data during the reliability test. (Sekaran, 2006). The coefficient alpha value ranges from 0 to 1, with less than 0.60 indicating poor internal consistency dependability (Hair, Wolfinbarger, Ortinau, & Bush, 2008).

Next, descriptive statistics will be used to describe and summarize the data into a meaningful way. It was used for data analysis because some of the issue addressed in the study involved perception. The reason for chosen descriptive techniques in this study because involved measurement, classification, comparison, data analysis, and interpretation with the advantage of describing the state of affairs as it exists.

Data will be described and summarised using descriptive statistics, Pearson's correlation will be used to evaluate the relationship between the independent and dependent variables. Pearson correlation coefficients vary between +1.00 and -1.00.

## FINDINGS

### Demographic Profile

Table 2 shows the demographic profiles of the respondents. There are a total 41 respondent which 27 female respondent and 14 male respondents. Most respondents are aged between 18 to 23 years old which 73.17%, 24 to 29 years old which 19.51%, 30 to 35 years old which 4.88%, 36 to 40 years old which 0%, and 41 years old and above which 2.44%. The status , student which 75.61% and work which 24.39%. The highest travel style of respondent is traveling with friends which is 48.78% and the lowest is traveling alone or solo.

### Reliability and Validity

The Rule of Thumb on Cronbach Alpha

Alpha Coefficient Range	Strength of Association
< 0.6	Poor
0.6 to < 0.7	Moderate
0.7 to < 0.8	Good
0.8 to < 0.9	Very Good
0.9 >	Excellent

Table 2  
(Source Hair et.al (2003);

Essential of Business Research Method)

The Alpha Reliability Coefficient for the Independent and Dependent Variables

Cronbach's Alpha analysis was used as the reliability test technique in this study. Its purpose is to assess the questionnaire's dependability. According to Hair et al (2003), an Alpha Coefficient range of less than 0.6 considers poor, 0.6 to 0.7 is considered moderate, 0.7 to 0.8 is considered good, 0.8 to 0.9 is considered very good, and 0.9 is considered excellent. The rule of thumb on Cronbach Alpha as table 2 below.

<b>Variable</b>	<b>Number of Question</b>	<b>Cronbach's Alpha Coefficient</b>	<b>Strength of Association</b>
Economy	5	0.907	Excellent
Infrastructure	5	0.907	Excellent
Attraction	5	0.855	Very Good
Destination Selection	5	0.890	Very Good
<b>Overall Variable</b>	<b>20</b>	<b>0.890</b>	<b>Very Good</b>

Table 3

(Source SPSS)

Table 3 show all the variable with number of questions, Cronbach's Alpha Coefficient value, and correlation strength. Overall variable has 20 questions with 0.890 Cronbach's Alpha Coefficient value which strength of association is very good. The highest value is 0.907 which is variables economy and infrastructure. Attraction and also destination selection shows very good strength of association because the values are 0.855 and 0.890. Conclusion, the questionnaire is acceptable and can be use in the study.

## CONCLUSIONS

During an actual study, the main objective of this pilot test research is to determine the validity and reliability of the measuring instruments that are factors in selecting Langkawi Island as a tourist destination. A pre-test was carried out to assess the content and face validity of the survey from a perspective of an expert. Furthermore, the test of reliability found that all of the items are trustworthy, with Cronbach's Alpha greater than 0.7, suggesting that no items should be deleted because they are considered good. Moreover, the study methodology was shown to be practical.

Overall, the questionnaire has been validated by examining its "reliability and construct" validity measures. The real survey, which is scheduled to collect 384 travellers', would be able to explain why travellers' chose Langkawi Island as a tourist destination. The findings of this study have some implications for existing knowledge in related domains and will be valuable for policymakers, tourist groups, and practitioners working to boost Malaysia's tourist industry. Meanwhile, it may serve as a model for future study.

## Reference

- Ahmad, S., Wasim, S., Irfan, S., Gogoi, S., Srivastava, A., & Farheen, Z. (2019). Qualitative v/s. Quantitative Research- A Summarized Review. *Journal of Evidence Based Medicine and Healthcare*, 6(43), 2828–2832.
- Akama, J. S., & Kieti, D. M. (2003). Measuring tourist satisfaction with Kenya's 1wildlife safari: a case study of Tsavo West National Park. *Tourism Management*, 24(1), 73–81.
- Aleksanyan, G. (2021, November 6). *THE CONCEPT OF TOURISM DESTINATION IN THE CONTEXT OF GEOGRAPHICAL SPACE*. 43(8), 30–31.  
[https://www.researchgate.net/publication/355958911\\_](https://www.researchgate.net/publication/355958911_)
- Aziz, A. (2002). An evaluation of the attractiveness of Langkawi Island as a domestic tourist destination based on the importance and perceptions of different types of attractions - ProQuest. *Proquest.com*. 46(12), 489-490
- Bhandari, P. (2020, June 5). *Data Collection | Definition, Methods & Examples*. Scribbr. 5(30), 45-50. <https://www.scribbr.com/methodology/data-collection/>
- Chancarar, S. (2023). *View of Thai Tourism and Economic Development: The Current State of Research*, 341(61), 47-60.  
<https://so04.tcithaijo.org/index.php/kjss/article/view/246746/167664>
- Davidovitch, N., & Eckhaus, E. (2018). The Influence of Birth Country on Selection of Conference Destination--Employing Natural Language Processing. *Higher Education Studies*, 8(2), 92–96.
- Ding, Z., Yao, Z., & Zhao, H. (2021). RA-GAT: Repulsion and Attraction Graph Attention for Trajectory Prediction. *2021 IEEE International Intelligent Transportation Systems Conference (ITSC)*, 30(4), 78-80.
- Faiz, M., Kanyan, A., Jati Kasuma, & Johanna Adlin Ahmad. (2016). *Determinants of factors and the growth of tourism industry in Langkawi Island*. 3(2): 13-

- Ghanem, J. (2017). Conceptualizing “the Tourist”: A critical review of UNWTO definition. 94(8), 68-73.  
<https://doi.org/http://hdl.handle.net/10256/14825>
- Heung, V. C. S., Qu, H., & Chu, R. (2001). The relationship between vacation factors and socio-demographic and travelling characteristics: the case of Japanese leisure travellers. *Tourism Management*, 22(3), 259–269.
- Kazdin, A. E. (2021). *Research design in clinical psychology*. 8(1), 34-40.  
[https://scholar.google.com/citations?view\\_op=view\\_citation&hl=en&user=wXIOwRoAAAAJ&citation\\_for\\_view=wXIOwRoAAAAJ:u-x6o8ySG0sC](https://scholar.google.com/citations?view_op=view_citation&hl=en&user=wXIOwRoAAAAJ&citation_for_view=wXIOwRoAAAAJ:u-x6o8ySG0sC)
- Liu, W., & Song, Z. (2020). Review of studies on the resilience of urban critical infrastructure networks. *Reliability Engineering & System Safety*, 193(5), 106-110. <https://doi.org/10.1016/j.ress.2019.106617>
- Markman, G. D., Lieberman, M., Leiblein, M., Wei, L., & Wang, Y. (2021). The Distinctive Domain of the Sharing Economy: Definitions, Value Creation, and Implications for Research. *Journal of Management Studies*, 58(4), 927–948. <https://doi.org/10.1111/joms.12707>
- Mintell (2011). Country report no.2, Asia Pacific May 2011. London: Mintel International Group Ltd. 7(30), 201-204.
- Muhamad Nasir, M. N., & Wongchestha, N. (2022). Parallel Mediators of Place Attachment and Tourist Motivation in Involvement and Destination Loyalty: A Conceptual Model. *International Journal of Hospitality & Tourism Systems*, 15 (2), 103-111.
- Nurhazani Mohd Shariff, & Azlan Zainol Abidin. (2020, October). *TOURISTS’ PERCEPTIONS OF LANGKAWI ISLAND AS A WORLD TOURISM DESTINATION*. *Geo Journal of Tourism and Geosites*, 32(4), 1264-1269.

- Park, J., Musa, G., Moghavvemi, S., Thirumoorthi, T., Taha, A. Z., Mohtar, M., & Sarker, M. M. (2019). Travel motivation among cross border tourists: Case study of Langkawi. *Tourism Management Perspectives*, 31, 63–71.
- Prentice, R. (1993). *Tourism and Heritage Attractions*, Routledge, London. 78(1), 120-131.  
[https://search.sl.nsw.gov.au/primoexplore/fulldisplay?docid=SLNSW\\_ALMA21139838580002626&context=L&vid=SLNSW&lang=en\\_US&tab=default\\_tab&query=any,contains,b1540133\\*](https://search.sl.nsw.gov.au/primoexplore/fulldisplay?docid=SLNSW_ALMA21139838580002626&context=L&vid=SLNSW&lang=en_US&tab=default_tab&query=any,contains,b1540133*)
- Rimmington, M. (2016). *Tourist Satisfaction with Mallorca, Spain, as an Off-Season Holiday Destination - Metin Kozak, Mike Rimmington, 2000*. *Journal of Travel Research*. 38(3): 260-269.
- Rutberg, S., & Bouikidis, C. (2018, March). *Focusing on the Fundamentals: A Simplistic Differentiation Between Qualitative and Quantitative Research*. 45(2), 209-212.
- Torrise, G. (2009). *Public infrastructure: definition, classification and measurement issues*.18(2),20-23.  
[https://www.researchgate.net/publication/23935428\\_Public\\_infrastructure\\_definition\\_classification\\_and\\_measurement\\_issues](https://www.researchgate.net/publication/23935428_Public_infrastructure_definition_classification_and_measurement_issues)
- Yuksel, F., Bramwell, B., & Yuksel, A. (1999). Stakeholder interviews and tourism planning at Pamukkale, Turkey. *Tourism Management*, 20(3), 351–360.  
[https://doi.org/10.1016/s0261-5177\(98\)00117-4](https://doi.org/10.1016/s0261-5177(98)00117-4)

# **Factor Affecting Memorable Tourism Experiences Towards Behavioural Intentions of Heritage Tourists**

**Siti Norsyahirah Bint Puniman, Siti Nur Azmira Binti Zakaria,  
Siti Nur Hamizah Binti Muhammad, Siti Nur Ismawati Binti Meswan, \*Dr Amin Jan**

*Faculty of Hospitality, Tourism and Wellness, Universiti Malaysia Kelantan,  
School of Management and Marketing, College of Business and Public Management,  
Wenzhou-Kean University, China*

---

## **ABSTRACT**

This research is being done to determine what influences heritage visitors' behaviour in terms of memorable travel experiences. The study's goals are to comprehend the connections between traveller involvement, destination image, and plans to return. A quantitative approach was applied in the investigation. Data was gathered using a survey design that employed a convenience sample strategy and distributed questionnaires. 150 questionnaire responses from chosen respondents will be collected for this study. In a nutshell, this study will show that great travel experiences will influence heritage tourists' behavioural intentions.

**Keywords: memorable tourism experiences, revisit intentions, visitor engagement, authenticity and destination image**

---

## **INTRODUCTION**

This chapter is about experience, which is an incredibly important part of life for today's traveller and has been called a megatrend. The term "experience" has been used in many ways. Students have referred to these encounters as "daily encounters" and "frontier experiences" (Pine and Gilmore) (1998) emphasise the importance of expertise throughout a genre's society, describing it as the result of the spike in economic progress that develops through the stages of the goods, commodities, and services economy. To gain a competitive advantage, the focus has shifted from products or services to expertise as another component. Experience is the heart and soul of industrial enterprises. Moreover, encounters with industrial enterprises are presented as pleasant, memorable, and interactive. (Oh, et al, 2007), as well as transient phenomena. When tourists visit a region or destination, they experience authentic, rewarding, meaningful, multisensory, and transform.



## **SIGNIFICANCE OF THE STUDY**

### **Theoretical Implications**

This study helps to review the existing literature on the link between MTE and behavioural intentions in the context of historical tourism in Malaysia Focus on behaviour after the experience. As part of historical tourism in Malaysia, this study showed how MTE can act as an intermediary between the Influence of visitor participation, authenticity and image of the destination on the return visit Intentions By focusing on a less studied historical tourism scenario, so will it helps better understand MTE's context-based perspective. This investigation expanded the literature on heritage tourism experiences by analyse the MTE scale in a heritage-tourism environment. He also highlighted interesting topics for future research, especially with regard to the possible influences of MTE.A In addition, (So et al. and Kim et al.) have developed visitor participation or MTE Scale (2012).

### **Practical Implications**

The findings of this study offer destination management useful suggestions for service improvements, identifying and sustaining MTE among visitors, and boosting the competitiveness of cultural tourism destinations. The richest experiences, according to (Pine and Gilmore 1998), establish a "sweet spot" in customers and influence their future decisions and behaviour. They are also frequently the most trustworthy source of information in terms of revisit intention and visitor communications. This is crucial since well-established tourist attractions have frequently overlooked the demands and experiences of visitors in favour of product-oriented marketing and management techniques (Zhang et al., 2018). As a result, they might fail to create and offer those experiences that can be mentioned only briefly when travellers discuss their experiences, which would have a negative impact on travellers' intentions to return and would also discourage them from posting positive reviews on travel websites, especially social media.

### **Methodological Implications**

This study will serve as a methodological base for the future studies intended on memorable tourism. The analysis of the target market's tourist needs and the tourist operator's capacity to meet those needs through the use of methods of observation, comparison, intuition, and logic, as well as the application of marketing management tools, forms the basis of the methodology of project management in the tourism industry. Furthermore, the tourism destinations need more practice and experienced tourists without negatively affecting revisit-intentions. To build a strategy that aligns with your objectives, vision, and mission in finishing the chart tourist in Malaysia, it is therefore necessary to examine the techniques or research

utilised in our industry as well as the theories or guiding concepts behind them. The Methods are the particular tools and practises you employed to gather and analyse data for the travel and tourism sector which can be directly attributed to the current paper's original methodological contribution.

## **LITERATURE REVIEW**

### **Heritage Tourism**

Heritage tourism is the practice of using the tangible and intangible remnants of the past as a source for tourists, focusing on living and architectural components of culture. It is one of the largest, most prevalent, and fastest-growing components of the tourism industry today. Heritage tourism is a key component of international travel consumption, making up 40% of all travel worldwide and 85% of the general populace. It reduces poverty and boosts local economies, and enables tourists to forge and enhance personal identities. MTE is important for tourism destinations to gain competitive advantage, but little research has been done on the capacity drivers of MTE within the context of legacy tourism, leading to gaps in current understanding.

### **Dependent Variable**

- **Revisit Intention**

### **Independent Variable**

- **Visitor Engagement**
- **Authenticity**
- **Destination Image**

## **Research Hypothesis**

The concerns that have an impact on this issue of memorable travel experiences are shown in the literature review as an independent variable, while the dependent variable is the intention to return. The hypothesis basically serves to summarise the research on how to find, assess, and establish the relationship between the three (3) independent variables and the dependent variables. Accordingly, the following hypotheses will be investigated for this research based on the study:

### **2.3.1 Relationship between visitor engagement and revisit intention.**

Traveller engagement improves customer support and optimises the visitor experience, and is a predictor of goal to return. Higher tiers of engagement with an area have a beneficial effect on tourists' attitudes, intentions to return, and loyalty.

#### **H1**

There is a significant relationship between visitor engagement and revisit intention.

### **2.3.2 Relationship between authenticity and revisit intention.**

Authenticity is an important concept in tourist stories, and has been identified as a predictor of journey enjoyment and satisfaction. Empirical research has found a link between authenticity and stories of tourists who have made purchases.

#### **H2**

There is a significant relationship between authenticity and revisit intention.

### **2.3.3 Relationship between destination image and revisit intention**

The destination image is made up of a traveller's information, assumptions, opinions, and impressions of a place, and the goal to go back to a destination is expected via satisfaction.

#### **H3**

There is a significant relationship between destination image and revisit intention.

## **Research Framework**

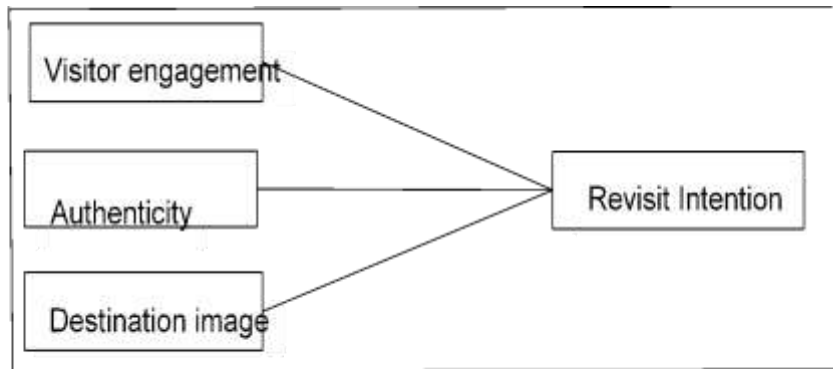

Figure 2.4.1 Conceptual Framework

The relationship between the independent and dependent variables in this study is depicted in the above figure. Issues that affect visitors' memorable travel experiences and behaviour intentions are carried out by the independent variables. Importantly, this study includes three (3) independent variables: tourist engagement, authenticity, and destination image. Each independent variable will have an impact on the dependent variable, which is the intention to return.

## **METHODOLOGY**

### **Research Design**

Research design is a technique and framework used to construct a research study. It can be divided into quantitative, qualitative and mixed methods. This study will use a quantitative research method, which can be developed by questionnaire survey through google form. It follows the causal research design. This method is the structural way to measure and collect any data that is obtained from various sources. In addition, quantitative can be determined by the relationship between causes of the issues and factors affected by the issues. According to Oxford Fajar (2013), this quantitative research method can be developed by questionnaire survey through google form. Because it uses a large-scale research survey, this study uses quantitative methods and questionnaires because it can spread the survey through an any online platform in social media including Instagram, face book , and so on.

### **Data Collection**

Data collection is the process of gathering, measuring, and analysing accurate insights for research objectives. In most cases, no matter the topic of research, data gathering is the first and most vital stage. Data collection is split by two which is primary and secondary. Data primary is that the style of data that the research collected through interview, survey and questionnaires, experiment and other. While data secondary may be a research method that involves using already existing data.

Nowadays, everyone has a smartphone and uses it for communication with each other without meeting or face to face with their friends, family and others. This study uses the google form questionnaire to reach the respondent to answer all the questions that research provides. Using social media like Telegram and WhatsApp can make it easier to reach the respondents, for example just share the link of google form for respondents from Kelantan.

Moreover, it is divided into primary and secondary data, and this study uses the google form questionnaire to reach respondents. The three sections of the questionnaire are Part A, Part B, and Part C. Part A focuses on the demographic segmentation of the respondents, while Part B discusses the variables suggested used in the study. Where nether is Part C focuses on visitor engagement, authenticity, and destination image.

### **Sampling**

This observer hired the non-opportunity sampling technique. It means that there's no chance that contributors of the studies population can be uncovered to the chosen pattern (Sekaran and Bougie, 2013). The pattern approach on this has a look at a convenience sampling technique. Convenience sampling is the exercise of accumulating facts from folks or agencies who're simply to be had to do so in Kelantan. The Convenience sampling is possibly the finest technique for fast accumulating a few simple records and is maximum regularly utilised all through the exploratory segment of a study. A survey made with Google Forms will be used to gather information from responders, and it will be distributed over social media channels. This technique can save money and time by not having to meet the person face to face.

### **Data Analysis**

Data analysis is the procedure of collecting, modelling and analysing the data which involves critical analysis and interpretation of figures and numbers to find out the reasons behind the emergence of the

main findings. There are a number of approaches and techniques for evaluating data and information gathered from a variety of various sources in order to extract the most important content. The information and data will be evaluated using the newest version of the Statistical Package for Social Sciences (SPSS) in this investigation. SPSS version 26 is a fantastic tool for folks who aren't statisticians but work in a variety of professions. SPSS version 26 is primarily used for processing and analysing statistical data and providing various outputs in order to answer objective research questions. There are numerous methods and approaches for evaluating data and information gathered from various sources in order to extract the most useful information.

The data analysis of this study will follow the following empirical tests.

- Descriptive analysis
- Correlation tests
- regression tests

## **FINDINGS**

The research instrument is an implementation used to measure and analyse data collection of a topic study. It contains five ways to conduct the survey, including questionnaires, observation, face to face interview, experiment and group discussion. The quantitative method of study will be used, consisting of three sections: demographic questions, dependent variables and independent variables. The data collection method will be applied in English and Malay, accessible for respondents' understanding.

Basically, there are three sections in questionnaires, section A for demographic questions. That consists of age, gender, employment status also their spouse employment status, areas and number of its children. Next, section B and section C will be discussing topics that relate to dependent variables and independent variables of study. Dependent variable (section B) topics apply on visitor engagement, authenticity and destination image. While independent variables (section C) develop questions about revisit intention. Generally, this data collection method will be applied in dwi-languages, which are English and Malay, accessible for respondents' understanding. The measurement of Likert code (from the scale 1 to 5) and questionnaires for this study are shown in the appendices section at the end of questions.

## DISCUSSION AND RECOMMENDATION

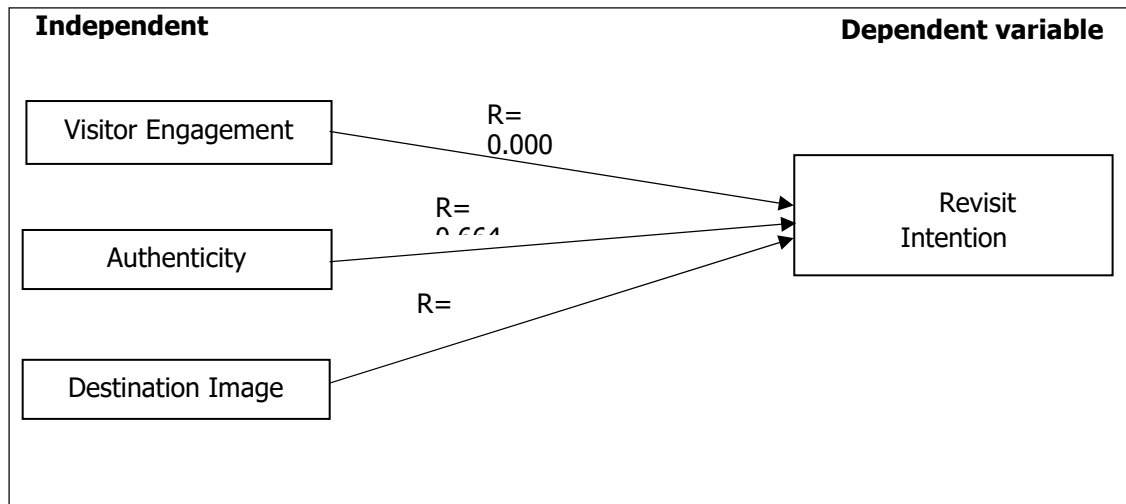

The data for the significant independent factors in relation to the dependent variable. The dependent variable, revisit intention, was found to be related to three independent variables: visitor engagement, authenticity, and destination image. Visitor engagement and destination image have the same significant value of 0.000 among these independent variables. 0.664 is the significant value for authenticity. As a result, visitor engagement, authenticity, and destination image are three distinct components that are linked to revisit intention.

For the recommendation, researchers should consider conducting in-depth interviews with respondents in person to gather more detailed data and answer questions about the impact of Covid-19 on memorable tourism experiences. Researchers should obtain permission from the police station to conduct face-to-face interviews, and improve internet connection support for those conducting interviews through Google Meet. Universities should publish qualitative research reports and provide secondary data sources to gather information. The study should be extended to other parts of Kelantan to obtain better results. For limited time, researchers could create open-ended questions in Google Forms and send them via WhatsApp, Telegram, Instagram, and email. Additionally, researchers should include all programmer students in university from the first year to the fourth year of study, reducing misunderstandings and biases.

## CONCLUSION

The purpose of this study was to identify the factors that influence the behavioural intentions of heritage tourists among students at the University Malaysia Kelantan. This study also created a conceptual framework and explored the elements that contributed to revisit intention in the tourist business. The conceptual framework is one of the major elements that have been discovered in relation to the research difficulties and past research studies. The researchers anticipate that the findings of this study will be useful to future studies.

## REFERENCES

- Abbasi, G. A., Kumaravelu, J., Goh, Y. N., & Singh, K. S. D. (2021). Understanding the intention to revisit a destination by expanding the theory of planned behavior (TPB). *Spanish Journal of Marketing-ESIC*.
- Akkucuk, U., & Ata, S. (2019). Clustering Tourists Based on Reason for Destination Choice: Case of Izmir. In *Ethical and Sustainable Supply Chain Management in a Global Context* (pp. 289-303). IGI Global.
- Akter, M., Sadekin, M. N., & Patwary, A. K. (2020). An Empirical Study on Students' Satisfaction from Mawlana Bhashani Science & Technology University, Bangladesh. *Review of Economics and Development Studies*, 6(2), 363-379.
- Alam, T. G. M. R. (2019). Comparative analysis between pre-test/post-test model and post- test-only model in achieving the learning outcomes. *Pakistan Journal of Ophthalmology*, 35(1).
- Alom, S., Patwary, A. K., & Khan, M. M. H. (2019). Factors affecting the turnover intention of Bangladeshi migrants in the United Arab Emirates: An empirical study on the hotel industry. *International Journal of Innovation, Creativity and Change*, 8(3), 344-360.
- Beerli, A., & Martín, J. D. (2004). Tourists' characteristics and the perceived image of tourist destinations: a quantitative analysis—a case study of Lanzarote, Spain. *Tourism management*, 25(5), 623-636.
- Chen, H., & Rahman, I. (2018). Cultural tourism: An analysis of engagement, cultural contact, memorable tourism experience and destination loyalty. *Tourism management perspectives*, 26, 153-163.
- Fengmin, Z., Baijun, W., Jiangtao, B., Li, L., & Patwary, A. K. (2022). Investigating revisit intention of medical tourists in China through nutritional knowledge, perceived medical quality, and trust in the physiologist: A recommendation on health tourism policy measures. *Frontiers in Public Health*, 10, 893497.
- Gordon Scott. (2021). Population. Retrieved December 17, 2022 from <https://www.investopedia.com/terms/p/population.asp>
- Hazbar, A. M. H., Alem Mohammed, A., & Karim, A. K. A. (2019). An Empirical Study of Factors Influencing hotel customers' online booking Intention. *مجلة العلوم التربوية و الدراسات الإنسانية*, (5), 1-17.
- Hernández-Rojas, R. D., del Río, J. A. J., Fernández, A. I., & Vergara-Romero, A. (2021). The cultural and heritage tourist, SEM analysis: the case of The Citadel of the Catholic King. *Heritage Science*, 9(1). <https://doi.org/10.1186/s40494-021-00525-0>
- Kolar, T., & Zabkar, V. (2010). A consumer-based model of authenticity: An oxymoron or the foundation of cultural heritage marketing? *Tourism management*, 31(5), 652-664.
- Li, L., Ragavan, N. A., Patwary, A. K., & Baijun, W. (2022). Measuring patients' satisfaction toward health tourism in Malaysia through hospital environment, nutritional advice, and perceived value: A study on Chinese exchange students. *Frontiers in public health*, 10, 893439.



- Li, L., Wu, B., & Patwary, A. K. (2022). How marine tourism promote financial development in sustainable economy: new evidences from South Asia and implications to future tourism students. *Environmental Science and Pollution Research*, 29, 1155-1172.
- Li, L., Wu, B., & Patwary, A. K. (2022). The psychosocial factors affecting chinese Outbound Exchange and mobility students' academic performance during COVID-19. *Frontiers in psychology*, 13, 872516.
- Mehmetoglu, M., & Engen, M. (2 Normando, D., Almeida, M. A. D. O., & Quintão, C. C. A. (2011). Analysis of the use of sample size calculation and error of method in researches published in Brazilian and international orthodontic journals. *Dental Press Journal of Orthodontics*, 16, 33-35.
- Moutinho, L. (1987). Consumer behavior in tourism. *European journal of marketing*.
- Nguyen Viet, B., Dang, H. P., & Nguyen, H. H. (2020). Revisit intention and satisfaction: The role of destination image, perceived risk, and cultural contact. *Cogent Business & Management*, 7(1). <https://doi.org/10.1080/23311975.2020.1796249>
- Nguyen Viet, B., Dang, H. P., & Nguyen, H. H. (2020). Revisit intention and satisfaction: The role of destination image, perceived risk, and cultural contact. *Cogent Business & Management*, 7(1). <https://doi.org/10.1080/23311975.2020.1796249>
- Normando, D., Almeida, M. A. D. O., & Quintão, C. C. A. (2011). Analysis of the use of sample size calculation and error of method in researches published in Brazilian and international orthodontic journals. *Dental Press Journal of Orthodontics*, 16, 33-35.
- OmniConvert. (2019). What is Sample Size? Definition - Omniconvert. Omniconvert. <https://www.omniconvert.com/what-is/sample-size/>
- Patwary, A. K., Roy, B., Hoque, R., & Khandakar, M. S. A. (2019). Process of developing a community based tourism and identifying its economic and social impacts: An Empirical study on Cox's Bazar, Bangladesh. *Pakistan Journal of Humanities and Social Sciences*, 7(1), 1-13.
- Prayag, G. (2009). Tourists' evaluations of destination image, satisfaction, and future behavioural intentions—the case of Mauritius. *Journal of Travel & Tourism Marketing*, 26(8), 836–853.
- Rindell, A. (2013). Time in corporate images: Introducing image heritage and image-in use. *Qualitative Market Research*, 16(2), 197–213.
- Sileyew, K. J. (2019). *Research design and methodology* (pp. 1-12). Rijeka: IntechOpen.
- Sumethokula, P., Patwary, A. K., Srinuanpanc, B., Srinuanpand, C., Suwandee, P., Thammathikulf, A., & Phanong, W. (2020). The potential of new tour repackaging for creative tourism among entrepreneurs in Nakhon Si Thammarat. *International Journal of Innovation, Creativity and Change*, 13(10), 1752-1771.
- Tasci, A. D., & Gartner, W. C. (2007). Destination image and its functional relationships.
- Woodside, A. G., & Dubelaar, C. (2002). A general theory of tourism consumption systems: A conceptual framework and an empirical exploration. *Journal of Travel Research*, 41(2), 120–132.
- Wu, B., Liu, S., Wang, J., Tahir, S., & Patwary, A. K. (2021). Assessing the mechanism of energy efficiency and energy poverty alleviation based on environmental regulation policy measures. *Environmental Science and Pollution Research*, 28, 40858-40870.
- Wu, B., Zhai, B., Mu, H., Peng, X., Wang, C., & Patwary, A. K. (2021). Evaluating an economic application of renewable generated hydrogen: A way forward for green economic performance and policy measures. *Environmental Science and Pollution Research*, 1-15.
- Yu, C. P., Chang, W. C., & Ramanpong, J. (2019). Assessing visitors' memorable tourism experiences (MTEs) in forest recreation destinations: A case study in Xitou nature education area. *Forests*, 10(8), 636.
- Zhang, H., Wu, Y., & Buhalis, D. (2018). A model of perceived image, memorable tourism experiences and revisit intention. *Journal of Destination Marketing & Management*, 8, 326–336.

# **Re-Visiting Community-Based Tourism Intention in Kelantan Malaysia: Insights for Tourists**

**Siti Nurliana Binti Mat Jaffar, Siti Nurul Asyiqin Binti Mohd Nor, Siti Nurul**

**Athirah Binti Hamizan, Siti Safwanah Binti Maput, \*Amin Jan**

*Faculty of Hospitality, Tourism and Wellness, Universiti Malaysia Kelantan,*

*School of Management and Marketing, College of Business and Public Management,*

*Wenzhou-Kean University, China*

---

## **ABSTRACT**

*Community-based tourism* is an important industry in helping to increase the interaction between the existing community-based diversity because it creates and strengthens the identity of a country. The purpose of this study is to identify factors that influence tourists to engage in community-based tourism in Kelantan, Malaysia. Therefore, this study examines the factors of tourist involvement directly and indirectly through the level of satisfaction at the tourist destination. Data will be collected from the cooperation of tourists to help provide an overview of the development of the community-based tourism industry in Kelantan, Malaysia. To investigate the involvement of tourists, this study will use the Statistical Package for Social Sciences (SPSS) which consists of descriptive analysis and correlation. In addition, the literature review proves that uniqueness, campaign and promotion, and accessibility are the main factors for tourists to start and continue to be involved with the community-based tourism industry. Uniqueness are the most significant factor of the independent variable is uniqueness between tourist involvement with community-based tourism in Kelantan, Malaysia.

**Keywords: Kelantan, Malaysia, Community-based Tourism, Re-visiting, Intention, Insight for Tourists.**

---

## **INTRODUCTION**

Tourism has become among the most crucial and quickly growing industries in the world. (2015) (Daniloska and Hadzi Naumova-Mihajlovska). This industry has made significant improvements towards becoming a critical engine of economic growth. Tourism accounts for 9% of worldwide GDP, according to the World Tourism Authority (2014). Furthermore, it is expected that over 1050 million foreign and more than 5 billion domestic tourists visited various tourist destinations in several countries in 2013. Based on the point of

view of society, it has been acknowledged that community engagement is an important component impacting people's support for the development of tourism, especially in rural areas.

Furthermore, in recent decades, tourism in South East Asia has grown considerably on both a national and international scale (Turner & Freiermuth, 2016). By 2025, the tourism sector in South East Asia is projected to directly support 15,510,000 jobs and more than USD 528 billion in GDP. Most people in rural areas, according to Mason and Cheyne [30], may have different perspectives on tourist development, resulting in different levels of community attachment and finally, influencing their support for tourism development. Tourism is considered as one of the most major sectors in South East Asia, coming next after manufacturing and agriculture, especially for Malaysia and Thailand. (2011) (Bhuiyan, Siwar, Ismail, Islam, and Ehsan).

The country's tourism industry, like those of other developing nations, is expanding (Shariff & Abidin, 2013). It substantially raises the country's GDP by producing foreign exchange, providing employment opportunities, increasing tax receipts, and increasing economic possibilities for the residents (Ibrahim, 2010; Jalis, Zahari, Izzat, & Othman, 2009). Malaysia's government has implemented strong action to develop this industry (Siti-Nabiha, Abdul Wahid, Amran, Haat, & Abustan, 2008). The Ministry of Tourism developed the Tourism Policy in 1992 to encourage the establishment of Malaysia's tourism industry. However, because of the diversity of Malaysia's culture, the value of tourism growth to local economies is different across the country.

Although community-based destinations for tourists are an increasing part of the tourism industry in countries that are developing such as Malaysia, concentrating on these locations in the country's isolated areas might offer an opportunity to effectively follow the federal government's tourism plan. 2017 (Chin & Lo). Community-based tourism (CBT) is among the most current type of tourist product, in which local communities organize and establish a great deal of the tourism-related events (Kaur, Jawaid, & Othman, 2016). While getting involved with community-based tourism, tourists may be able to learn more about a community's way of existence, heritage, and customs (Kaur et al., 2016). Tourism is an acknowledged factor to the rise in expenditure on tourism in the majority of emerging countries (Promsivapallop & Kannaovakun, 2017).

There are three objectives in this research:

- 1) To investigate the relationship between the atmosphere and re-visit intention.

- 2) To examine the relationship between cultural environment and re-visit intention.
- 3) To identify the relationship between the destination brand and re-visit intention.

## **SIGNIFICANCE OF THE STUDY**

### **1. Practically Significance**

This study is the practice to help develop community-based tourism in Malaysia. The researcher expects this study to increase the number of local and foreign visitors who want to visit Malaysia. Considered the following changes to increase the number of tourists participating in Malaysia's community-based tourism. Uniqueness is an important consideration since it is a national emblem that aids in the promotion and attraction of tourists to Malaysia.

### **2. Theoretical Significance**

This study adds to the understanding of Malaysian tourists' intention to return home. This research will add to the knowledge gained from the environment of developing countries. Several sites are important subjects for local community-based tourism destinations in Kelantan, Malaysia, with great potential for strategic market differentiation. These places are becoming increasingly popular among domestic and foreign tourists as national community based tourism destinations. The surrounding area is uninhabited and has the same and unique resources and environment for tourism related activities. This community-based tourism destination is owned and operated by the local community.

### **3. Methodology Significance**

This study will serve as a methodological foundation for studies that fail but will be revisited in Kelantan, Malaysia. The population of the present study consisted of tourists who visited several community-based tourism sites in Kelantan, Malaysia, in accordance with the methodology's importance. Because of the popularity of its nature attractions and community based attractions relative to other states in Malaysia and Kelantan was selected to represent Malaysia.

## **LITERATURE REVIEW**

The dependent variable and independent variable are discussed in the literature review. A variable that is being measured or tested in an experiment is known as a dependent variable.

In an experiment, a dependent variable is a variable that can change depending on the independent variable, which is a variable that a researcher can change throughout the research. Researchers can look at the dependent variable to see how the independent variable influences it. Unlike the independent variable, the researcher makes no changes to the dependent variable during an experiment.

The second stage is to alter a component of the study, and the final step is to assess the prospective outcomes. In this literature review, the researcher has discovered three points in the independent variable. If the value of an independent variable changes, the researcher is in control of the change and it is not the consequence of external influences. The researcher chooses the independent variable. Unlike the dependent variable, whose values are still being determined by the experiment, the researcher can identify what it is.

### **RESEARCH HYPOTHESIS**

In this study, three hypotheses had been examined namely;

H1: In Kelantan, Malaysia, there is an important relationship between the atmosphere and re-visiting community-based tourism intention: Insights for Tourists.

H2: In Kelantan, Malaysia, there is an important relationship between the cultural environment and re-visiting community-based tourism intention: Insights for Tourists.

H3: In Kelantan, Malaysia, there is a considerable relationship between the destination brand and re-visiting community-based tourism intention: Insights for Tourists.

### **RESEARCH FRAMEWORK**

For the purpose of examining the association between independent variables (atmosphere, cultural environment, and destination brand) and dependent variable (re-visit intention), the following research methodology was developed. Furthermore, this framework can establish which of the following characteristics appear to be the most influential factors of returning to community-based tourism in Kelantan, Malaysia: Tourist Information.

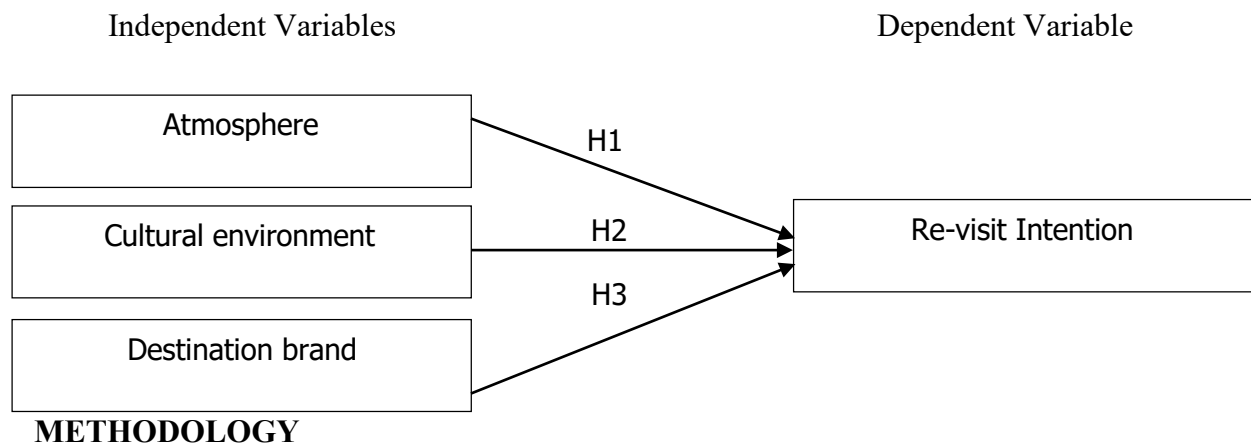

## Research Design

The researcher will use this causal study approach for this assessment. Informal study can be defined as examining the connection between cause and effect between multiple variables. Many businesses regularly apply causal analysis. It allows the evaluation of the implications of process advancements and modifications to current exercises. The researcher will employ a technique that is quantitative. A quantitative research approach is a method of determining data from a questionnaire or survey that is used during the study.

This is the most common method for study participants to provide more data. A quantitative research design, according to Bhandari (2020), is a method for gathering data to figure out who, where, and what the researcher wants to learn. For conducting the research and evaluate the data obtained, the tools of this study will include quantitative analysis with a design that is descriptive. These researchers are using such an approach to identify the elements that affect visitors' engagement with cultural tourism as well as the desire to return to community-based tourism.

## Data Collection

Warner creates a data gathering strategy, such as the randomly response technique, that allows researchers to collect data while protecting respondents' privacy. Data collection is defined as a technique for obtaining and evaluating data for research and validation purposes. Data is gathered to investigate a problem, as well as to find its solution and potential future trends. The data collection procedure used in this study is questionnaire. The survey questionnaire is a type of data collection technique used to gather, analyse, and interpret the various viewpoints of a group of individuals from a specific population.

The survey questionnaire will be used in many different fields, including psychology, marketing, research, and politics. After they are finished, all of the questionnaire will be collected and then the researcher will count the number of questionnaires that have been distributed to them. By using this data collection procedure which is questionnaire the researcher can save their time and this method is also relatively inexpensive. There are two sorts of data that will be collected in this procedure which is primary data and secondary data. Primary data can be gathered using a variety of methods.

### Sampling Method

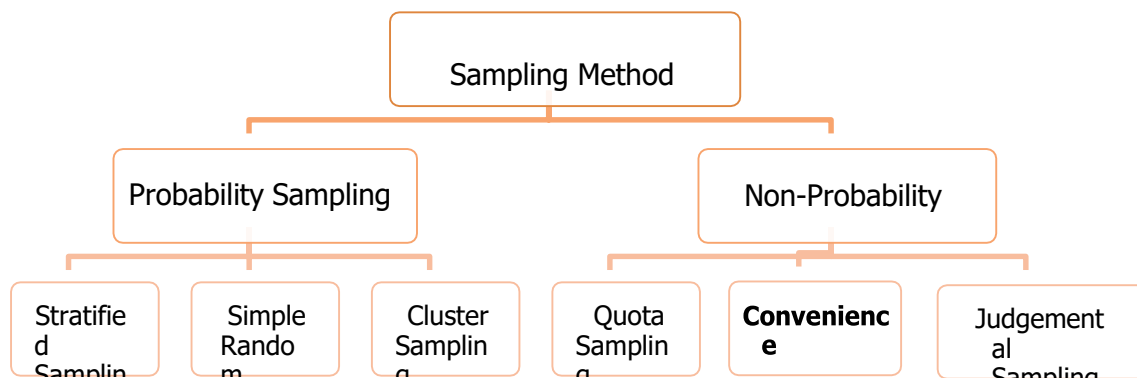

In this part, the probability sampling and non-probability sampling methods were utilised to meet the study's purpose. The sampling technique is made up of two methods: probability sampling, which includes stratified, simple, and cluster sampling. Quota, convenience, and judgemental sampling are examples of non-probability sampling. In this study, however, the researcher chose convenience sampling. Convenience sampling is a method used by researchers to acquire market research data from a pool of conveniently available respondents. It is the most often used sample technique since it is fast, easy, and inexpensive. Convenience sampling procedures were utilized to meet the study's aim, and respondents were carefully picked to check that they were the intended respondents. When extra inputs are not required for the primary inquiry, researchers use convenience sampling. There are no requirements for being a part of this sample.

### Data Analysis

The research would prepare the analysis for analysis once it had been processed, arranged, and cleansed. Depending on the objectives, several data analysis approaches are available to comprehend, evaluate, and draw conclusions. If you want to understand the

messages in the data, you can also utilize data visualization to explore the data in a graphical style.

Statistical data models such as correlation and regression analysis can be employed to determine the relationships between data variables. The study may be made more straightforward, and the results are easier to express with the aid of these models that are descriptive of the data. As a result, these operations are iterative. The process may call for extra Data Cleaning or new Data Collection.

1. Correlations

It will demonstrate the presence of a correlation between the two variables without explaining either the source or the effect. To accomplish the goal of this research study, the researcher will employ the most appropriate technique, namely Pearson correlation can be employed to identify the connection among independent variables, such as uniqueness, campaign and promotion, and accessibility, and the dependent variable, which is tourist engagement with Malaysian cultural tourism.

2. Regression

The advancement that follows correlation is regression. This technique is employed when attempting to forecast a variable based on the value of another variable. The dependent variable is the one we're trying to indicate or the outcome variable. The variable we use to predict the other variable's value is the independent variable or the predictor variable. For example, you might apply linear regression to determine whether test achievement can be anticipated based on revision time, whether cigarette intake can be predicted based on smoking length, and so on. Researcher must use multiple regressions if you have two or more independent variables rather than simply one.

**FINDINGS Table 1: Descriptive Analysis Result**

<b>Descriptive Statistics</b>					
	N	Minimum	Maximum	Mean	Std. Deviation
age	200	1	50	2.57	3.948
gender	200	1	2	1.84	.368
status	200	1	2	1.12	.326



education	200	1	5	2.79	.662
Atmosphere: IV1	200	3	5	4.61	.557
Cultural environment: IV2	200	3	5	4.66	.528
destination brand: IV3	200	3	5	4.67	.521
revisit intension: DV	200	3	5	4.63	.547

The mean as well as the standard deviation of the independent and dependent variables are shown in Table 1. The independent variable with the highest mean is destination brand (4.67). The cultural environment follows in second with a score of 4.66. The lowest mean is 4.61 for the atmosphere. The researcher only has one dependent variable in this study, which is re-visit intention, which is 4.63.

**Table 2: Reliability Test**

Reliability Test	N	Cronbach's Alpha	Cronbach's Alpha Based on Standardized Items	N of items
TOTAL	200	.958	.960	16

Table 2 shows Cronbach's Alpha for all independent and dependent variables of dependability was 0.958, whereas Cronbach's Alpha for standardized items was 0.960. The coefficient values of the variables were found to be excellent in terms of dependability level.

A common rule of thumb for characterizing internal consistency using Cronbach's Alpha is presented in the table below.

**Table 3: Pearson Correlation**

<b>Correlations</b>
---------------------

		Atmosphere	Cultural Environment	Destination Brand	Revisit Intension
Atmosphere	Pearson Correlation	1			
	Sig. (2-tailed)				
	N	200			
Cultural Environment	Pearson Correlation	.757**	1		
	Sig. (2-tailed)	.000			
	N	200	200		
Destination Brand	Pearson Correlation	.742**	.839**	1	
	Sig. (2-tailed)	.000	.000		
	N	200	200	200	
Revisit Intension	Pearson Correlation	.690**	.780**	.834**	1
	Sig. (2-tailed)	.000	.000	.000	
	N	200	200	200	200
**. Correlation is significant at the 0.01 level (2-tailed).					

Table 3 shows the Pearson Correlation. The objective of this analysis is to determine whether there is a correlation between dependent variable and independent variable. Cronbach's Alpha was 0.958 for all independent and dependent factors of dependability, whereas Cronbach's Alpha for standardized items was 0.960. The coefficient values of the variables were found to be excellent in terms of dependability level. A common rule of thumb for characterizing internal consistency using Cronbach's Alpha is presented in the table below.

## DISCUSSION & RECOMMENDATION

The findings in this study from this study has shown that there is a significant association ( $r = 0.690$ ,  $p=0.01$ ) between atmosphere (IV 1) and re-visit intention (DV). Pearson Correlation 0.690 suggested a relationship between atmosphere and want to return.

Simultaneously, the significant level of both variables, 0.000, was shown to be very significant, with a modest degree of significance. To conclude, atmosphere and re-visit intention affect the tourist's decision whether they want to visit Kelantan again.

Secondly, the findings also found the significant relationship between cultural environments and re-visit intention. There was a significant connection between the cultural environment (IV 2) and re-visit intention (DV) ( $r = 0.780$ ,  $p=0.01$ ). Pearson Correlation 0.780 suggested a relationship between cultural environment and re-visit intention. Simultaneously, the significant level of both variables, 0.000, was shown to be very significant, with a modest degree of significance. The researcher found that the re-visit intention and the cultural environment had a good relationship based on the data. To conclude, cultural environment also affects the tourist's decision to re-visit Kelantan again. This is because cultural environment is also an important factor. If the cultural environment in a state is good it will make tourists want to revisit the place.

Lastly, the findings also indicate a significant relationship between the destination brands and re-visit intention. The relationship between destination brand (IV 3) and re-visit intention (DV) is significant ( $r = 0.834$ ,  $p=0.01$ ). Pearson Correlation 0.834 demonstrated a favourable relationship between destination brand and inclination to return. At the same time, the significant level of both variables, 0.000, was shown to be very significant, with a moderate degree of significance. The researcher found that the re-visit intention and the cultural environment had a positive connection based on the information gathered. To conclude all of this destination brand is the main factor why tourists need to re-visit Kelantan when they have free time. But it does not mean that The only cause why tourists come Kelantan is because of the destination brand. The other factors such as atmosphere and cultural environment also play a crucial role in determine whether tourists want to visit Kelantan again or not.

This study, including many other research, has limitations. It is limited sample size to perform whole respondents of the re-visiting community-based tourism intention in Kelantan, Malaysia: insights for tourists. Due to the time and resource limits, the researchers have distributed 200 questionnaires which measured as a limited sample size to conduct for study.

The limitations also use questionnaires through quantitative. It was being facing during the finishing this task is understanding of questionnaire by the respondents. Moreover, the respondent didn't fully understand what the question need and they just filling the answer without knowing either the answer is correct or not. Lastly is the researchers only focus on

three variables from International Journal of Business and Society, Vol. 20 No 2, 2019, 585604. It was a quite hard for researchers to do this study because all of the questionnaire must related with the variables that has been provided in the journal.

Future researchers are recommended to expand the study area from one state to another state around Malaysia especially Kedah who have the best place such as Langkawi to get a higher number of respondents based on the re-visiting community-based tourism intention, insights for tourists. This will provide a higher number of respondents allowing the results to increase. Future researchers are also recommended to change the method from quantitative to qualitative as their questionnaires because the method of qualitative is much easier to get the data. The researcher just need to go an interview the owner or the event organizer as the respondents and can also improve their skill in communicate with other people and help them to become a brave and build more confidence for their self. Future researchers also can use other variables from another journal. This can help this study to get more info especially the journal that are related for this study wants to do. It also can help this study become a good journal because it can give much information to the others people.

## **CONCLUSION**

This study aims to explore the factors influencing tourists' engagement in community based tourism in Kelantan, Malaysia. The research aims to identify factors that influence tourists to engage in this industry, both directly and indirectly, through the level of satisfaction at the tourist destination. The study will use the Statistical Package for Social Sciences (SPSS) to investigate the involvement of tourists.

The study's findings will help inform the development of the community-based tourism industry in Kelantan, Malaysia. The findings will be implemented in directing the growth of the industry as well as the development of the region's tourism sector. The study's findings will be used to inform the development of the tourism industry in Kelantan, Malaysia, and to inform the development of the tourism industry in the region.

In conclusion, this study provides valuable insights for tourists interested in community-based tourism in Kelantan, Malaysia. By examining the factors influencing tourists' engagement in this industry, the study aims to contribute to the growth and development of the tourism industry in the region.

## REFERENCES

- Abdul, K., & Lebai, D. (2010). *Malaysia as an Imagined Destination: The Selling Points: Universiti Utara Malaysia Press.*
- Akter, M., Sadekin, M. N., & Patwary, A. K. (2020). An Empirical Study on Students' Satisfaction from Mawlana Bhashani Science & Technology University, Bangladesh. *Review of Economics and Development Studies*, 6(2), 363-379.
- Alom, S., Patwary, A. K., & Khan, M. M. H. (2019). Factors affecting the turnover intention of Bangladeshi migrants in the United Arab Emirates: An empirical study on the hotel industry. *International Journal of Innovation, Creativity and Change*, 8(3), 344-360.
- Baloglu, S., & Brinberg, D. (1997). *Affective images of tourism destinations. Journal of Travel Research*, 35(4), 11-15.
- Beerli, A., & Martin, J. D. (2004). *Factors influencing destination image. Annals of Tourism Research*, 31(3), 657-681.
- Bhandari, P. (2020) *An Introduction to Quantitative Research.*
- Bhuiyan, M. A. H., Siwar, C., Ismail, S. M., Islam, R., & Ehsan, D. (2011). *Potentials of Islamic tourism: A case study of Malaysia on east coast economic region. Australian journal of basic and applied sciences*, 5(6), 1333-1340.
- Bowen-Jones, E. D. (2003). *Economic commodity or environmental crisis? An interdisciplinary approach to analyzing the bushmeat trade in central and west Africa. Area* 35:390–402.
- Castri, F. a. (2002). *Tourism, Biodiversity and Information*, . The Netherlands. .
- Castri, F. S. (2002). *Introduction: Information, Communication and Education for Tourism Development, in: Tourism, Biodiversity and Information. The Netherlands*, : pp.
- Chin, C. H., & Lo, M. C. (2017). *Rural tourism quality of services: Fundamental contributive factors from tourists' perceptions. Asia Pacific Journal of Tourism Research*, 22(4), 465- 476
- Cole, S. T., & Chancellor, H. C. (2009). *Examining the festival attributes that impact visitor experience, satisfaction and re-visit intention. Journal of Vacation Marketing*, 15(4), 323- 333.
- Cresswell, T. (2015). *Place: An introduction. West Sussex, UK: John Wiley & Sons*
- Daniloska, N., & Hadzi Naumova-Mihajlovska, K. (2015). *Rural tourism and sustainable rural development. Economic Development*, 17(3), 307-320.
- Fengmin, Z., Baijun, W., Jiangtao, B., Li, L., & Patwary, A. K. (2022). Investigating revisit intention of medical tourists in China through nutritional knowledge, perceived medical quality, and trust in the physiologist: A recommendation on health tourism policy measures. *Frontiers in Public Health*, 10, 893497.
- Godde, P. (1998). *Community-Based Mountain Tourism: Practices for Linking*
- Graci, S. (2013). *Collaboration and partnership development for sustainable tourism.*
- Hazbar, A. M. H., Alem Mohammed, A., & Karim, A. K. A. (2019). An Empirical Study of Factors Influencing hotel customers' online booking Intention. *مجلة العلوم التربوية و الدراسات الإنسانية*, (5), 1-17. <https://www.scribbr.com/methodology/quantitative-research>

- Huang, Y., Qu, H., & Cao, Y. (2016). *Towards an integrative model of destination attachment: dimensionality and influence on revisit intention*. *Tourism Travel and Research Association: Advancing Tourism Research Globally*, 11.
- Ibrahim, Y. (2010). *Tourism development and community perception towards sociocultural change in Tioman Island*. *Tourism Research in Malaysia (eds.), DinK and Mapjabil J. Universiti Utara Malaysia Press: Sintok*, 159-178.
- Kaur, P., Jawaid, A., & Othman, N. B. A. (2016). *The impact of community-based tourism on community development in Sarawak*. *Procedia-Social and Behavioral Sciences*, 2(1), 15- 26
- Kunjuraman, V. &. (2017). *Challenges of community-based homestay programme in Sabah, Malaysia: Hopeful or hopeless?* *Tourism Management Perspectives*, 21,1–9. <https://doi.org/10.1016/j.tmp.2016.10.007>
- Kuperan, K. a. (1998). *Blue water crime: deterrence, legitimacy, and compliance in fisheries*. *Law & Society Review* 32:309– 334.
- Lekaota, L. (2015). *The importance of rural communities' participation in the management of tourism management – A case study from Lesotho*. *Worldwide Hospitality and Tourism Themes*, 7(5), 453–462. <https://doi.org/10.1108/WHATT-06-2015-0029>
- Li, L., Ragavan, N. A., Patwary, A. K., & Baijun, W. (2022). Measuring patients' satisfaction toward health tourism in Malaysia through hospital environment, nutritional advice, and perceived value: A study on Chinese exchange students. *Frontiers in public health*, 10, 893439.
- Li, L., Wu, B., & Patwary, A. K. (2022). How marine tourism promote financial development in sustainable economy: new evidences from South Asia and implications to future tourism students. *Environmental Science and Pollution Research*, 29, 1155-1172.
- Li, L., Wu, B., & Patwary, A. K. (2022). The psychosocial factors affecting chinese Outbound Exchange and mobility students' academic performance during COVID-19. *Frontiers in psychology*, 13, 872516.
- Lo, M. C., Ramayah, T., & Yeo, A. W. (2016). *Harmonizing Rural Tourism and Rural Communities in Malaysia*. *Journal of Sustainable Development*, 9(4),
- Moore, R. L., & Graefe, A. R. (1994). *Attachments to recreation settings: the case of rail-trail users*. *Leisure Sciences*, 16(1), 17-31.
- Mountain Forum*. April 13– May 18 .  
[http://www.mtnforum.org/resources/library/cbmt\\_01.htm](http://www.mtnforum.org/resources/library/cbmt_01.htm)
- Nair, V. &. (2015). *Successful community-based tourism approaches for rural destinations*
- Osman, I., Ahmad, N. H., Ahmad, Z. A., Husin, A., Bakar, S. A., & Tanwir, N. D. (2010). Patwary, A. K., Roy, B., Hoque, R., & Khandakar, M. S. A. (2019). Process of developing a community based tourism and identifying its economic and social impacts: An Empirical study on Cox's Bazar, Bangladesh. *Pakistan Journal of Humanities and Social Sciences*, 7(1), 1-13.
- Promsivapallop, P., & Kannaovakun, P. (2017). *A comparative assessment of destination image, travel risk perceptions and travel intention by young travellers across three ASEAN countries: a study of German students*. *Asia Pacific Journal of Tourism Research*, 22(6), 634-650.
- Rawat, K. B. (2015). *Innovative practices in education to empower rural communities*.

- Sethi, S. A. (2008). *Interactions between poaching and management policy affect marine reserves as conservation tools*. *Biological Conservation* 141:506–516.
- Shariff, N. M., & Abidin, A. Z. (2013). *Community attitude towards tourism impacts: Developing a standard instrument in the Malaysian context*. *EJournal of Social Science Research*, 386-397.
- Siti-Nabiha, A., Abdul Wahid, N., Amran, A., Haat, H. C., & Abustan, I. (2008). *Towards a sustainable tourism management in Malaysia*. *LESIJ-Lex ET Scientia International Journal*, 15(2)
- Solomon, J. S. (2007). *Estimating illegal resource use at a Ugandan park with the Randomized Response Technique*. *Human Dimensions of Wildlife* 12:75–88.
- Sumethokula, P., Patwary, A. K., Srinuanpanc, B., Srinuanpand, C., Suwandee, P., Thammathikul, A., & Phanong, W. (2020). *The potential of new tour repackaging for creative tourism among entrepreneurs in Nakhon Si Thammarat*. *International Journal of Innovation, Creativity and Change*, 13(10), 1752-1771.
- Taherdoost, H. (2016). *Sampling Methods in Research Methodology; How to Choose a Sampling Technique for Research*. *International Journal of Academic Research in Management (IJARM)*, 23-24.
- Thailand: *Worldwide Hospitality and Tourism Themes*, 7(5), 516–529.  
<https://doi.org/10.1108/WHATT-06-2015-0027>
- Tourism Geographies*, 15(1), 25–42.  
<https://doi.org/10.1080/14616688.2012.675513>
- Understanding motivation, empowerment and sustainability outcomes of women homestay entrepreneurs in West Malaysia. A preliminary analysis. Paper presented at the ICSB World Conference Proceedings*.
- Wu, B., Liu, S., Wang, J., Tahir, S., & Patwary, A. K. (2021). *Assessing the mechanism of energy efficiency and energy poverty alleviation based on environmental regulation policy measures*. *Environmental Science and Pollution Research*, 28, 40858-40870.
- Wu, B., Zhai, B., Mu, H., Peng, X., Wang, C., & Patwary, A. K. (2021). *Evaluating an economic application of renewable generated hydrogen: A way forward for green economic performance and policy measures*. *Environmental Science and Pollution Research*, 1-15.

# The Nexus Of Information And Communication Technology (Ict) And Sustainable Tourism Marketing Among Owner's Homestay

Syazana Binti Rosdi, Siti Zulaiha Binti Ramli, Siti Zulaika Binti Othman, Suria Atikah Binti Samsuri, \*Amin Jan

*Faculty of Hospitality, Tourism and Wellness, Universiti Malaysia Kelantan,  
School of Management and Marketing, College of Business and Public Management,  
Wenzhou-Kean University, China*

---

## ABSTRACT

*One of the most significant modern challenges confronting many rural tourism groups and destinations is maintaining stability. ICT expertise has a wide variety of consequences for the achievement of sustainable rural tourism. The goal of this study is to develop a theoretical model for homestays in Malaysian rural society that incorporates information from ICT competency and sustainable tourism marketing literature. The purpose of this study was to investigate the relationship between ICT competency and sustainable tourist marketing in the setting of rural homestays in Malaysia. A self-administered questionnaire was used in conjunction with a disproportionate stratified random sample procedure to reflect participant attitudes. This survey included 180 owner homestays in Kelantan. To verify the study hypothesis, a multiple regression method was used. According to the study results, there is a strong relationship between the antecedent (ICT competency) and the consequent (sustainable tourism marketing). The report also suggests using sustainable tourism marketing as features and capabilities strategy to encourage and monitor the long-term effectiveness of rural tourism. The study aims to provide a commitment to Malaysian tourism, where sustainability is acknowledged as a working system aspect and long-term objective.*

---

**Keywords:** Information and communication technology, The Ministry Of Tourism, Arts, Culture, Corporate social responsibility, General Practice

---

## INTRODUCTION

Information technology is also referred to as information and communication technology (ICT). It highlights the importance of offers an effective network and the convergence of computers and telecoms. It also includes the specific item, networking, memory, and corporate software that users need to access, save, transfer, comprehend, and alter information. Researcher focus on owner's homestay in Kota Bharu, Machang, Bachok and Pasir Puteh, Communication technology (ICT) and sustainable tourism marketing could be further expanded to advance their homestays



## **SIGNIFICANCE OF THE STUDY**

### **PARTIAL SIGNIFICANCES OF STUDY**

The main prerequisite for promoting sustainable tourism is information and communication technology (ICT) competence. Expanding their information technology knowledge and increasing the share of Information technology users in rural tourist industry should be the objectives of policymakers. Information and communication technology (ICT) proficiency develops metrics for tracking tourists' sustainable travel practises, and the sustainable transformation of rural tourism goods. Information and communication technology (ICT) offers priceless chances to manage the visitor experience, support cutting-edge tourism products, and create novel marketing methods. Improvements in rural living styles and social and economic development are influenced by information and communication technology (ICT) expertise.

### **THEORETICAL SIGNIFICANCES OF STUDY**

When used in contrast with information and communication technology (ICT) competency, this study helps to illustrate the triple bottom line hypothesis. To enhance the societal, economical, and environment sustainability aspects of a rural community-based homestay offering, the triple bottom line theory appears to be an appropriate basis. A unique contribution to the literature on sustainable tourism is made by the model, which demonstrates agreement here among theory is a qualitative and the findings of its components. The usefulness of this causal model is increased by the fact that it is not limited to a particular location or tourism environment.

## **LITERATURE REVIEW**

ICT use was explored in reference to the UN Organisation 2030 Sustainable Development Agenda (UNO). The degree to which a business is aware of this and efficiently manages data inside the firm is known as its ICT competency. The three ICT competence pillars focus on resources that show the group's aptitude for understanding and utilising ICT technologies and procedures that are anticipated to handle market and customer data (Tippins & Sohi, 2003). A tourism company's ICT competence is made up of ICT Processes, Skill levels, and ICT Products. ICT items are conceptualised as computer equipment, application, and support staff (Tippins & Sohi, 2003). ICT management is defined as a company's utilisation of ICT to manage marketplace and client information (Tippins & Sohi, 2003).

## **VARIABLE EXPLANATION**

## **1. INDEPENDENT VARIABLE**

The first independent variable is Environmental sustainability tourism marketing practices. The need to maintain natural resources while maintaining conserving global ecosystems for future and current wellbeing and quality of life is known as environmental sustainability. Because many climate-related decisions do not have an immediate impact, among the most significant characteristics of environmental sustainability is all forward nature.

The second independent variable is CSR practices. Corporate social responsibility is refer to managing idea that urges businesses to take cultural and physical factors into account in their daily operations and consumer interactions. CSR, sometimes known as the "Triple-Bottom-Line Approach," describes an industry's attempts to uphold its commitments to financial, physical, and cultural goals while still achieving consumer and shareholder expectations.

The last independent variable is Economic sustainability tourism marketing practices. Economic sustainability related to measures which promote long-term economic expansion, while not drastically compromising the society's basic, environmental and health, and cultural components. This means that the government sector, in particular, will encourage jobs and industries that enhance the environment and people's well-being.

## **2. DEPENDENT VARIABLE**

Dependent for this research is ICT competency. The architecture and elements that allow installation software are referred to as information and communications technology. Despite the lack of a single, universal definition of ICT, it is broadly acknowledged to refer to all equipment, switches and routers, software, and systems that collaborate together to allow organizations and individuals, for example, companies, charitable groups, authorities, and crime firms to communicate in the virtual environment.

### **Theoretical framework**

Sustainability refers to a country's, a group of social structures, or a cultural firm's long-term vitality. Sustainability is known as a generational ethical where current generations' environmental and economic decisions do not limit the possibilities for future generations to experience comparable degrees of prosperity, usefulness, or well-being (James Meadowcroft, 2022). In order to ensure societal (justice and equality), economic, and environmental sustainability in the development of a sustainability travel industry and destinations, STM develops market tactics (Cristobal-Fransi et.al, 2020). The "Triple Bottom Line" (TBL) refers to these three sustainability pillars (Elkington, 2004).

## **Research Hypothesis**

Understanding the relationship between ICT and sustainable tourist marketing is essential for the development and the tourist industry's success (Ali & Frew, 2014). ICT is a crucial tool for improving sustainable marketing strategies, and it has a favourable relationship with the likelihood that tourism organisations will adopt sustainability marketing innovations (Divisekera & Nguyen, 2018). Effective sustainability marketing can dramatically raise tourists' understanding of their effects on sustainability with the aid of ICT (UNWTO, 2017). ICT integration in the tourism industry is thought to benefit sustainability marketing. In fact, one of the main factors influencing the sustainable expansion of the tourist industry is the adoption and ICT adoption by tourism businesses (homestays) (Divisekera & Nguyen, 2018).

To position ICT as a key enabler of environmental sustainability, knowledge of environmental sustainability is required (Ojo & Fauzi, 2020). By increasing resource usage efficiency and transforming homestay marketing tactics into more environmentally friendly ones, ICT aids tourist businesses (homestays) in their pursuit of environmental sustainability (Wang, Chen, & Benitez-Amado, 2014). In order to attain professional socially sustainable outcomes, productive sector on ICT increase productivity of procedures, and systems and help to make more readily available CSR data for partners (Uyar et al., 2020). By generating financial gains for residences in popular tourist areas, innovative ICT use supports sustainable tourism marketing (Gretzel et al., 2020). The following hypotheses can be developed in light of the topic regarding ICT proficiency and the role it plays in marketing communications practises that were just mentioned.

### **H1**

ICT Competency positively affects Environmental Sustainability Marketing practices of Homestays in Malaysia.

### **H2**

ICT Competency positively affects the CSR practices of Homestays in Malaysia.

### **H3**

ICT Competency positively affects Economic Sustainability Marketing practices of Homestays in Malaysia.

## Research Framework

The researchers have established a framework to explore the relationship between ICT and sustainable tourist marketing based on the previous literature evaluation. Consequently, the conceptual framework is depicted in the diagram below.

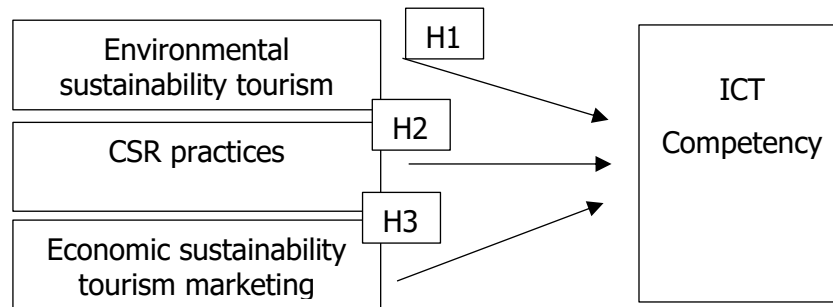

**Figure 1: Conceptual Framework**

Environmental sustainability tourism marketing practices are the responsibility to protect global ecosystems and natural resources for both present and future health and quality of life. most important components of environmental stability its upwards component, because many climate-related actions do not have an immediate impact. Indeed, according to the US Environmental Protection Agency, it serves current requirements without endangering the potential of the outcomes to satiate future needs. As a self-regulatory business model, corporate social responsibility (CSR) practise helps a corporation be socially responsible to their own, its partners, and the broader public. Businesses that use sustainable business practises, also known as "governance," are conscious of how their actions affect all facets of society, including monetary, cultural, and lifestyle factors. This implies that the public sector, in particular, will support occupations and businesses that improve the environment and the welfare of people.

## METHODOLOGY

### Research Design

A research design describes the steps taken to gather, examine, analyse, and present data in research investigations. In other words, the study's design defines how the crucial information will be gathered, examined, and used to address the research question. Surveys were applied in this study because they allow for the collection of quantitative data and the application of a deductive hypothesis testing strategy to examine the association between variables. Casual research can be used to evaluate marketing campaigns, enhance internal procedures, and improve business planning. The best methods

for meeting your demands can be determined by understanding how one scenario impacts another. The survey questionnaire was conducted among Malaysian host families. The respondents' data were gathered using a disproportionate stratified sampling technique. In order to examine seven or fewer constructs, the current study proposes a sample size of 180 respondents (Hair et al., 2018). The overall number of visitors at homestays in Kelantan, Malaysia that have been registered, as of June 2018, according to the MOTAC report.

## **Data Collection**

Data collection is obtaining, quantifying, and evaluating relevant information for study purposes using a dependable, and acknowledged methodology. Researchers can assess their hypotheses based on the evidence gathered. Primary or secondary data sources may be used in data collection. The type of data obtained by research through questionnaires. While secondary data was gained from textbooks and journals, this is a research strategy that incorporates the use of already collected data. The real questionnaire had 180 responses of owners and was administered in Kelantan. Researchers utilise Google Forms to save money and time by having respondents complete the questionnaire more quickly and effectively.

The Google form has three parts. For example, section A, B, and C. The first section involves questions regarding demographics of the respondent's segmentation and has six questions to answer. That consists of gender, nationality, homestay location, units, duration, and type of room. Meanwhile, section B discusses the variables suggested used in this study. It will discuss the independent variable, Environmental Sustainability Marketing practices, CSR practices and Economic Sustainability Marketing practices. Section C will focus on all of the dependent variables, such as the affected of ICT Competency.

## **Sampling**

Through the use of sampling, the researcher may extrapolate data about the population from the findings of a sample of the population without needing to look at every single person. In the sampling method, the researcher selects some elements of the population as the focus of the study. Several different sampling techniques are available, and they can be split into two groups. For example, probability sampling and non-probability sampling. Probability sampling is the process of selecting individuals from a community that are reflective of the community. When it comes to quantitative research, there are four fundamental kinds of selecting processes. Simple random, sampling process,

sampling techniques, and cluster sampling are some of them. In this study, the researcher chose a convenient sampling technique. The researcher takes samples from homestay details. Researchers selected a sample of detailed of owner in homestays that located in Kelantan.

## **Data Analysis**

Regression analysis is a class of data analysis for determining the relations between a dependent variable and one or even more independent variables. The researcher is employing the Statistical Package for the Social Science in this study (SPSS). A collection of network applications has been combined to become SPSS. The main use of this programme is the evaluation of social science-related empirical data.

Additionally, SPSS is a cutting-edge piece of software that researchers use to process crucial data in a straightforward manner. Working with data is a difficult and time-consuming task, but with the help of a few tricks, this programme can manage and operate data with ease. These techniques are applied between different data variables to analyse, manipulate, and produce a distinctive pattern. Additionally, the output can be represented graphically so that a user can quickly understand the result.

This study will use the following analysis:

12. Descriptive analysis
13. Corelation analysis
14. Regression analysis

## **FINDINGS**

### **Demographic Analysis**

#### **4.2.1 Respondent Demographic Profile**

##### 4.2.1.1 The number of respondents based on Gender.

<b>Gender</b>	<b>Frequency</b>	<b>Percent</b>
Male	68	38
Female	112	62
Total	180	100

Table 1: statistic table based on gender

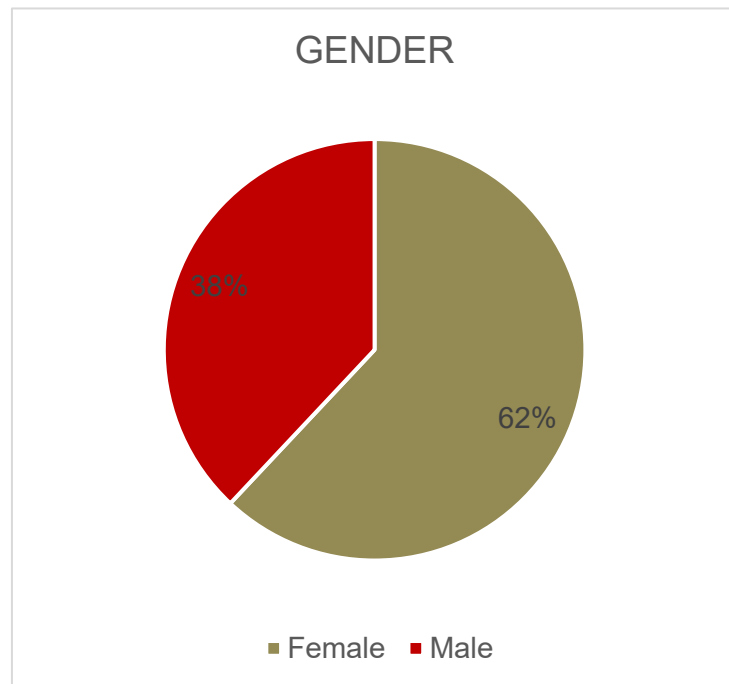

Figure 1: Pie chart of respondent based on gender

Figure 1 shows the percentage of the respondent that based on their gender. Total of all respondents is 180 respondents. Out of 180 respondents the highest number of genders is female with 62% (N=112) while the male has 38% (N=68). This result shows that the percentage of female and male respondents is balanced, which increase the study validity.

#### 4.2.1.2 The number of respondents based on Nationality.

Nationality	Frequency	Percent
Local	153	85
Foreign	27	15
Total	180	100

Table 2: statistic table based on nationality

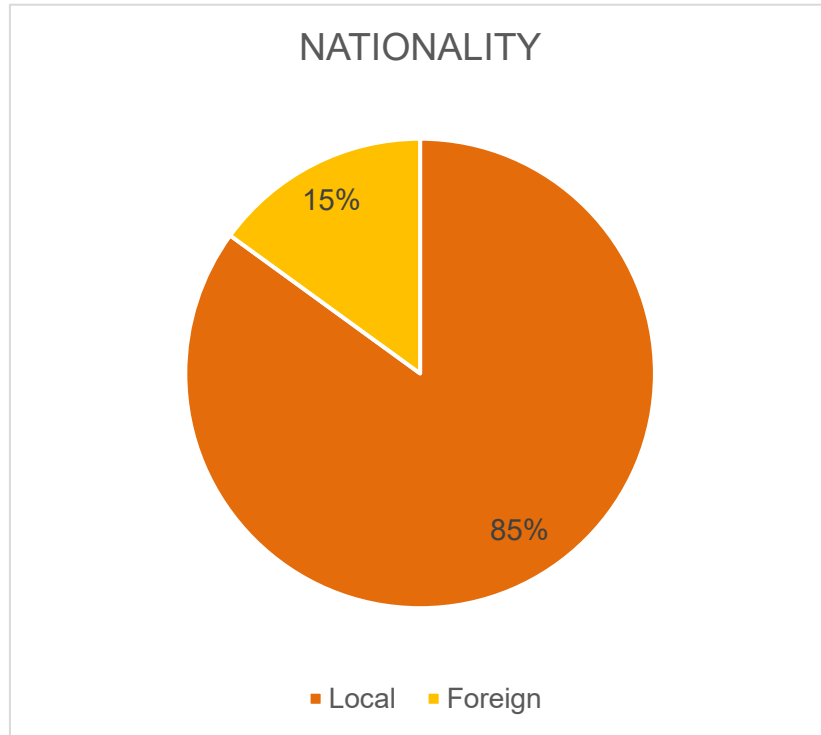

Figure 2: Pie chart of respondent based on nationality

Based on the result from Figure 2, the table show the statistic table that based on nationality of the respondents. In this research, the local respondents have the highest percentage compared to the foreign. Local respondents have higher percentage with 85% (N=153) respondents. While foreign have 15% (N=27) respondents.

#### 4.2.1.3 The number of respondents based on Location.

<b>Location</b>	<b>Frequency</b>	<b>Percent</b>
Kota Bharu	100	56
Machang	22	12
Bachok	28	15
Pasir Puteh	30	17
Total	180	100

Table 3: statistic table based on location



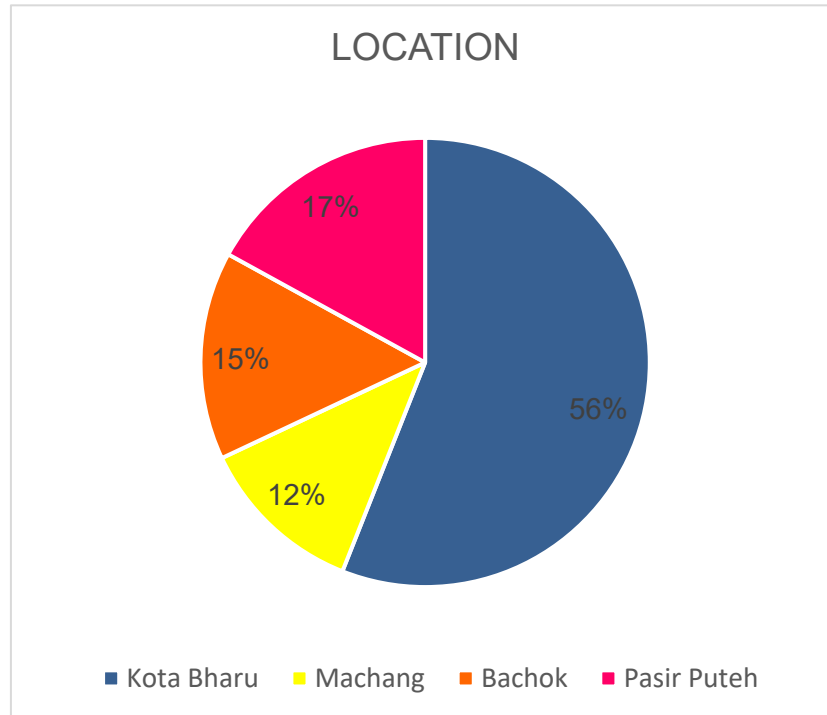

Figure 3: Pie chart of respondent based on location

Figure 4 illustrate the respondents based on respondents' location. The highest of location with 56% (N=100) respondents is homestays at Kota Bharu. While 17% (N=30) of the respondents have homestays at Pasir Puteh which is the second highest on location. The followed by 15% (N=28) respondents have homestay at Bachok. And the last location is Machang certificate which is 12% (N=22) respondents.

#### 4.2.1.4 The number of respondents based on Duration.

Duration	Frequency	Percent
One	68	38
Two	46	25
Three	34	19
More than three	32	18
total	180	100

Table 4: statistic table based on duration

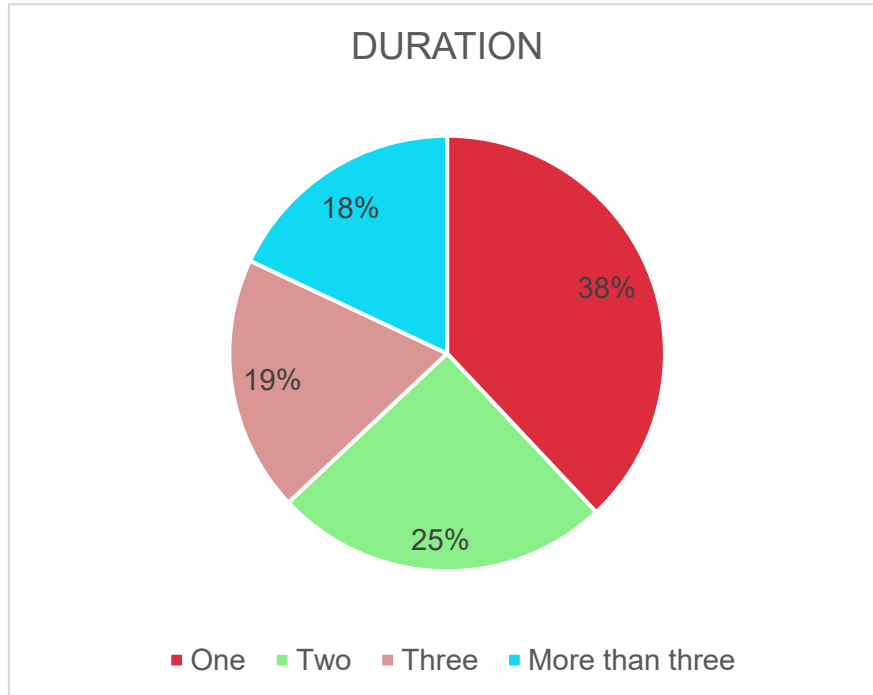

Figure 4: Pie chart of respondent based on duration

Figure 4 shows the percentage of the respondent that based on duration. Out of 180 respondent the highest of duration is one that homestay unit's respondents have with 38% (N=68) respondents followed by second highest is two units with 25% (N=46) respondents. The followed by 19% (N=34) respondents have three homestay units. And the last duration is more than three units which is 18% (N=32) respondents.

#### 4.2.1.5 The number of respondents based on Type of Rooms.

Type of rooms	Frequency	Percent
Single	50	28
Double	103	57
Dorm type	22	12
Others	5	3
total	180	100

Table 5: statistic table based on type of rooms

Figure 5: Pie chart of respondent based on type of rooms

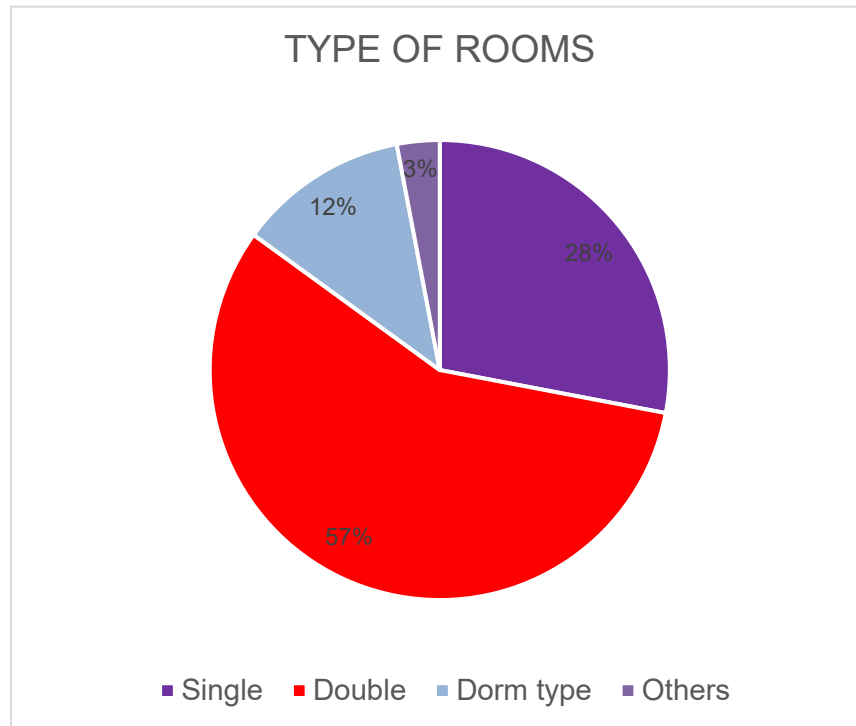

Figure 5 shows the frequency and percentage of the respondent that based on types of rooms their homestays. This questionnaire elicited responses from 180 people. Out of 180 respondent the highest number type of rooms is double room with 57% (N=103) respondents followed by second highest type of rooms is single room with 28% (N=50) respondents. While the third highest is dorm type with 12% (N=22) respondents and the last one is others with 3% (N=5) respondents.

## DESCRIPTIVE ANALYSIS

For independent variable 1. The highest response is question 1 and question 2. The question is “We safeguard the environment as a whole” and “We inform our guests about our environmental practices during their stay” which is 43% respondents’ response for strongly agree. While for the question “When our guests come, we enlighten them about our environmental practices” with 42% respondents’ response for agree. This is accurate because protecting the environment is a vital objective that calls for group actions.

For independent variable 2. The highest response for this table is question “We provide staff training possibilities” which is 52% respondents was response for agree. While question “We take an active part in social and cultural events. Traditional games, traditional dances, traditional cuisines, and traditional art are all examples” with 49% respondents was response for agree and “Regardless of gender, ethnicity, nationality, or religion, we treat all of our employees fairly and without any forms of abuse or discrimination” with 49% respondents was response for strongly agree. Both of this question is the highest response by respondents. And the next question is “We advise our staff to participate in community service” and “We provide employees consistent career possibilities” with 47% respondents for agree.

For independent variable 3. The highest response for this independent variable is question 9 which is “In order to ensure that future generations have a better future, we have invested in our homestay to help under-privileged sections of the society” with 49% respondents’ response for agree. While the second highest is question “We are dedicated to enhancing the safety of the communities where we conduct business. For example, providing self-employees opportunities and reducing poverty by employment and business creation” dan “we contribute to the social and economic well-being of women and rural residents by creating career chances and generating revenue” with 48% respondents response for agree.

For dependent variable (DV). The highest response is question 15 and 16 which is “To store and process information for our homestay accommodations, we rely on ICT such as reservation software, and property management software” and “The management of our ICT is one of the primary responsibilities of an executive we've hired such as reservation software and property management software” with 49% respondents’ response for agree. The second highest is question “Information and communication technologies (ICT) knowledge is possessed by certain of our personnel. Example: Computers, smart phones, printer” with 48% respondents’ response for agree. And the last one question “We understand how to develop communication connections with our present clients using the most recent social media platforms. Example: Facebook and Instagram” with 46% respondents’ response for strongly agree while the question “When it comes to handling customer information, we regularly use decision-support systems. Example: social media and mobile apps, also with 46% respondents’ response but for agree.

## RELIABILITY ANALYSIS

Reliability Test	N	Cronbach's Alpha	Cronbach's Alpha Based on Standardized Items	N of items
TOTAL	180	.947	.950 ?	16

Based on the reliability results shown above, the researcher has verified all of the independent and dependent variables. For all independent and dependent factors of dependability, Cronbach's Alpha indicated a value of 0.947, whereas Cronbach's Alpha based on Standardised items reveals a value of 0.950. The coefficient values of the variables range as excellent in terms of reliability level, as was demonstrated. A common guideline for characterising internal consistency using Cronbach's Alpha is presented in the table below.

## PEARSON CORRELATION ANALYSIS

**Table: Result of Pearson Correlation Analysis**

		Correlation				
		EST	CSR	ESTM	ICT	
EST	Pearson Correlation	1				
	Sig. (2-tailed)					
	N	180				
CSR	Pearson Correlation	.715**	1			
	Sig. (2-tailed)	0.000				
	N	180	180			
ESTM	Pearson Correlation	.743**	.793**	1		
	Sig. (2-tailed)	0.000	0.000			
	N	180	180	180		

ICT	Pearson Correlation	.552**	.601**	.719**	1	
	Sig. (2-tailed)	0.000	0.000	0.000		
	N	180	180	180	180	
**. Correlation is significant at the 0.01 level (2-tailed).						

The table below displays the Pearson Correlation Analysis results for the three independent variables and the dependent variable. For independent variable 1, the association is significant at the 0.01 level (2-tailed). It's a positive relationship. The result of Pearson correlation is a Pearson correlation that is significant at the 0.01 level.

## DISCUSSION AND RECOMMENDATION

First discussion is that there are positive value of Pearson Correlation 0.552 showed a relationship between economic sustainability tourism and information communication technology (ICT). Secondly, The positive value of Pearson Correlation 0.601 showed a relationship between CSR practice and information communication technology (ICT). Lastly, the positive value of Pearson Correlation 0.719 showed a relationship between environmental sustainable tourism marketing and information communication technology (ICT).

The first recommendation is that researcher increase number of ICT user. For example, researcher can use any platform to promote to people especially people that are not knowing much about hidden homestays. It will bring profit to rural homestays because people nowadays will only go to stay in popular places. The second recommendation is that researcher is that researcher should increase overall ICT knowledge. Researchers should learn more about the topic that they are studying to make difficulties easier to deal with. For example, use internet to look into detail about information and communication technology (ICT). The third recommendation is that researcher should explain more detail about the questionnaire to respondent. For example, explain each question to respondent to make them give the right answer. Some respondent cannot read every question due to the age factor. Lastly, researcher need to be more knowledge about the definition of topic that researcher choose to studied. For example, search more definition about the same topic because there are many meaning that researcher can get if they explore more about it.

## CONCLUSION

In conclusion, this study is proposed to examine The Nexus of Information and Communication Technology (ICT) and Sustainable Tourism Marketing among homestay owners in Kota Bharu, Machang, Bachok and Pasir Puteh. In addition, this research can be used as a reference by homestay operators in the districts of Kota Bharu, Machang, Bachok and Pasir Puteh, who conduct research on ICT for homestays. The results obtained in Chapter 4 using (SPSS) were further explored, and inferences were made from the findings. Based on the results, almost all respondents answered that they have almost less than a year of experience in operating a homestay.

## REFERENCES

- A.Livingston, S. (2018). Test Reliability, Basic Concepy. from <https://www.ets.org/Media/Research/pdf/RM-18-01.pdf>
- Additional informationNotes on contributorsXavier FontDr Xavier Font is professor of sustainability marketing at the University of Surrey. (n.d.). Sustainability and marketing in tourism: Its contexts, Paradoxes, approaches, challenges and potential. Taylor & Francis. Retrieved December 21, 2022, from <https://www.tandfonline.com/doi/full/10.1080/09669582.2017.1301721>
- Akter, M., Sadekin, M. N., & Patwary, A. K. (2020). An Empirical Study on Students' Satisfaction from Mawlana Bhashani Science & Technology University, Bangladesh. *Review of Economics and Development Studies*, 6(2), 363-379.
- Alom, S., Patwary, A. K., & Khan, M. M. H. (2019). Factors affecting the turnover intention of Bangladeshi migrants in the United Arab Emirates: An empirical study on the hotel industry. *International Journal of Innovation, Creativity and Change*, 8(3), 344-360.
- Bevans, R. (2022, December 7). Hypothesis testing: A step-by-step guide with easy examples. Scribbr. <https://www.scribbr.com/statistics/hypothesis-testing/>
- Brown, R. (2021, April 3). Retrieved from <https://www.durangoherald.com/articles/what-is-sustainable-tourism-marketing/>
- Cristobal-Fransi, E., Daries, N., Ferrer-Rosell, B., Marine-Roig, E., & Martin-Fuentes, E. (2020, March 2). Sustainable Tourism Marketing. MDPI. Retrieved January 4, 2023, from <https://www.mdpi.com/2071-1050/12/5/1865>
- CSR technology - A game changer. (n.d.). Retrieved December 24, 2022, from <https://www.goodera.com/blog/csr-technology-gamechanger>
- Emeritus. (July 2022). 5 Types of Research Design, Elements and Characteristics.
- Encyclopædia Britannica, inc. (n.d.). Sustainability. Encyclopædia Britannica. Retrieved December 21, 2022, from <https://www.britannica.com/science/sustainability#ref329831>
- FATIMAH, Y. & PUJIARTO, B. Sustainable nature tourism development through ICT implementation: A case of Indonesian Pines Village. AIP Conference Proceedings, 2019. AIP Publishing LLC, 020027.

- Fengmin, Z., Baijun, W., Jiangtao, B., Li, L., & Patwary, A. K. (2022). Investigating revisit intention of medical tourists in China through nutritional knowledge, perceived medical quality, and trust in the physiologist: A recommendation on health tourism policy measures. *Frontiers in Public Health*, 10, 893497.
- Fernando, J. (2022, May 27). Retrieved from <https://www.investopedia.com/terms/c/corp-social-responsibility.asp>
- Hair, J. F. (2018). *Advanced issues in partial least squares structural equation modeling*. Los Angeles: SAGE
- Hazbar, A. M. H., Alem Mohammed, A., & Karim, A. K. A. (2019). An Empirical Study of Factors Influencing hotel customers' online booking Intention. *مجلة العلوم التربوية و الدراسات الإنسانية*, (5), 1-17.
- Hypothesis Testing - Statistics How To. (2023, February 22). *Statistics How To*. <https://www.statisticshowto.com/probability-and-statistics/hypothesis-testing/>
- Hysa, B., Karasek, A., & Zdonek, I. (2021, January 20). Social media usage by different generations as a tool for Sustainable Tourism Marketing in society 5.0 idea. MDPI. Retrieved January 4, 2023, from <https://www.mdpi.com/2071-1050/13/3/1018>
- ICT and sustainable development: Implications for the tourism industry ... (n.d.). Retrieved January 4, 2023, from [https://www.researchgate.net/publication/350515525\\_ICT\\_and\\_Sustainable\\_Development\\_Implications\\_for\\_the\\_Tourism\\_Industry](https://www.researchgate.net/publication/350515525_ICT_and_Sustainable_Development_Implications_for_the_Tourism_Industry)
- IGI Global. (n.d.). What is technology acceptance model (TAM). Retrieved December 29, 2022, from <https://www.igi-global.com/dictionary/extension-technology-acceptance-model-hospital/29485>
- Kenpro. (2016, February 22). Sampling procedures. KENPRO. Retrieved December 29, 2022, from <http://www.kenpro.org/sampling-procedures/>
- Li, L., Ragavan, N. A., Patwary, A. K., & Baijun, W. (2022). Measuring patients' satisfaction toward health tourism in Malaysia through hospital environment, nutritional advice, and perceived value: A study on Chinese exchange students. *Frontiers in public health*, 10, 893439.
- Li, L., Wu, B., & Patwary, A. K. (2022). How marine tourism promote financial development in sustainable economy: new evidences from South Asia and implications to future tourism students. *Environmental Science and Pollution Research*, 29, 1155-1172.
- Li, L., Wu, B., & Patwary, A. K. (2022). The psychosocial factors affecting chinese Outbound Exchange and mobility students' academic performance during COVID-19. *Frontiers in psychology*, 13, 872516.
- Momoh, O. (July 2022). *Population Definition in Statistics and How to Measure It*.
- Patwary, A. K., Roy, B., Hoque, R., & Khandakar, M. S. A. (2019). Process of developing a community based tourism and identifying its economic and social impacts: An Empirical study on Cox's Bazar, Bangladesh. *Pakistan Journal of Humanities and Social Sciences*, 7(1), 1-13.
- Pratt, M. K. (2019, July 26). Retrieved from <https://www.techtarget.com/searchcio/definition/ICT-information-and-communications-technology-or-technologies?amp=1>
- Research, A. (January 2022). *Causal Research*.
- SHAFIEE, S., GHATARI, A. R., HASANZADEH, A. & JAHANYAN, S. 2019. Developing a model for sustainable smart tourism destinations: A systematic review. *Tourism Management Perspectives*, 31, 287-300.



- Sirisilla, S. (2022, November 6). Writing Limitations of Research Study — 4 Reasons Why It Is Important! Retrieved from <https://www.enago.com/academy/limitations-of-research-study/>
- Statistics | Definition, Types, & Importance. (2023, May 8). Encyclopedia Britannica. <https://www.britannica.com/science/statistics/Hypothesis-testing>
- Stephanie. (2022, December 12). Composite reliability: Definition. Statistics How To. Retrieved December 29, 2022, from <https://www.statisticshowto.com/composite-reliability-definition/>
- Sumethokula, P., Patwary, A. K., Srinuanpanc, B., Srinuanpand, C., Suwandee, P., Thammathikul, A., & Phanong, W. (2020). The potential of new tour repackaging for creative tourism among entrepreneurs in Nakhon Si Thammarat. *International Journal of Innovation, Creativity and Change*, 13(10), 1752-1771.
- Taylor, L., & Hochuli, D. F. (2015). Creating better cities: how biodiversity and ecosystem functioning enhance urban residents' wellbeing. *Urban ecosystems*, 18(3), 747-762
- What is average variance extracted. IGI Global. (n.d.). Retrieved December 29, 2022, from <https://www.igi-global.com/dictionary/average-variance-extracted/45252>
- What is CSR? UNIDO. (n.d.). Retrieved December 29, 2022, from <https://www.unido.org/our-focus/advancing-economic-competitiveness/competitive-trade-capacities-and-corporate-responsibility/corporate-social-responsibility-market-integration/what-csr#:~:text=Corporate%20Social%20Responsibility%20is%20a,and%20interactions%20with%20their%20stakeholders.>
- Wu, B., Liu, S., Wang, J., Tahir, S., & Patwary, A. K. (2021). Assessing the mechanism of energy efficiency and energy poverty alleviation based on environmental regulation policy measures. *Environmental Science and Pollution Research*, 28, 40858-40870.
- Wu, B., Zhai, B., Mu, H., Peng, X., Wang, C., & Patwary, A. K. (2021). Evaluating an economic application of renewable generated hydrogen: A way forward for green economic performance and policy measures. *Environmental Science and Pollution Research*, 1-15.

# Issues Influencing the Use of Smart Tourism Apps Among Malaysia Tourism Stakeholders

Syazeilawaty Binti Musa, Tan Heng Bin, Tan Ween Kee, Tay Chee Ling

*\*Amin Jan*

*Faculty of Hospitality, Tourism and Wellness, Universiti Malaysia Kelantan,  
School of Management and Marketing, College of Business and Public Management,  
Wenzhou-Kean University, China*

## ABSTRACT

---

Demand in the global tourism sector significantly impacts the number of visitors visiting Malaysia. As a result, the government has given this industry considerable consideration since it has a good impact, particularly in terms of increasing local residents' income. Even if they are aware of the diversity of Malaysian ethnicity and culture, it has been found that personnel in the tourist sector in Malaysia lack information regarding the adoption of the smart tourism idea. For instance, cultural sensitivity and Halal food ignorance would be problematic for both international tourists and locals. In addition, the major reason Malaysia has not adopted smart tourism is the absence of advertising and information on historical sites in Malaysia and attractive places to visit. The purpose of this study is to influence the use of smart tourism apps among Malaysia tourism stakeholders. The purpose of this study is to the issue pertaining to elements impacting the memorable tourist experience and Smart Tourism (ST) behavioural goals that serve as the independent variable. Three independent variables—Trust, Culture, and Technology Readiness. Each of these independent factors has an impact on the dependent variable, Smart Tourism (ST). The study's core data will be collected via a structured questionnaire and examined using SPSS software. The poll will be sent to 100 people who plan to visit any Malaysian destination again. The data in this study was processed using descriptive, reliability tests, and correlation analyses.

---

**Keywords: Smart Tourism Apps, Malaysia Tourism Stakeholder**

---

## INTRODUCTION

By utilizing Information and Communications Technology (ICT) tools, a destination can be deemed as promoting smart tourism when it facilitates easy access for tourists and visitors to various goods, services, locations, and experiences related to tourism and hospitality. This can include features such as mobile apps, online platforms, digital guides, and interactive services that enhance the overall travel experience.

Investing in smart tourism development allows a city or destination to enhance its resources, attract more tourists, and shine brighter in the global tourism landscape. By incorporating technology into various aspects of tourism, such as transportation, accommodation, attractions, and visitor services, destinations can streamline processes, improve efficiency, and offer personalized experiences to visitors.

The benefits of smart tourism extend beyond businesses and the tourism industry. Individuals in the community also enjoy improved infrastructure and services, such as efficient transportation systems, smart city initiatives, and enhanced connectivity. This can lead to a higher quality of life for residents and a positive overall image for the destination.

However, the global COVID-19 outbreak has severely impacted all industries, with the travel and tourism sector being particularly affected. Travel restrictions, health concerns, and reduced tourist demand have caused significant disruptions to the tourism industry. In response to these challenges, there is now a greater emphasis on revitalizing communities and diversifying tourism offerings by leveraging smart tourism concepts.

The focus has shifted towards smart tourism destinations that leverage technology to enhance safety, provide contactless experiences, and enable efficient management of tourist flows. This includes implementing health and safety protocols, adopting digital solutions for ticketing and reservations, utilizing data analytics for crowd management, and promoting virtual and augmented reality experiences.

In the context of the study in Malaysia, the aim is to examine the factors influencing the use of smart tourism apps by tourism stakeholders. The study focuses on three main factors: Trust, Culture, and Technology Readiness.

Trust refers to the perceptions of reliability, credibility, and confidence in using smart tourism apps. This includes factors such as the goodwill of the app provider, predictability of app performance, and perceived competence in delivering the desired outcomes.

Culture encompasses cultural dimensions that may influence the adoption and acceptance of smart tourism apps. These dimensions include power distance (the extent to which power is distributed unequally in society), uncertainty avoidance (the degree to which a society tolerates uncertainty and ambiguity), individualism/collectivism (the emphasis on individual or collective goals), and masculinity/femininity (the values placed on assertiveness and competitiveness versus nurturance and collaboration).

Technology readiness refers to individuals' attitudes and perceptions towards technology. This includes factors such as insecurity (concerns about data privacy and security), innovativeness (the willingness to try new technologies), discomfort (the level of comfort with using technology), and complexity (perceived difficulty in using and understanding technology).

The study aims to get a deeper understanding of Malaysia's smart tourism business and provide insights into how tourism stakeholders can efficiently embrace and utilise smart tourism apps by evaluating these variables. Finally, this research can help to establish policies and activities that encourage the growth and sustainability of Malaysia's smart tourism business.

## **SIGNIFICANCE OF THE STUDY**

The primary contribution of the paper focuses on the relationships between trust, culture, and technology and how these moderately affects smart tourism through social media. This work not only advances our understanding but also has consequences for how we all learn and live. Customers for travel agencies, responsible governmental entities, and conscientious, ecologically friendly travel. Other things the study wants to underline include a culture of trust and technical readiness. In addition, there is a unique blend of traditional traits (smart tourism) with predictive elements (trust, culture, and technical preparation). The study looks at how social media affects the link between the two in a moderating way. Both of these are standard variables and predictor variables. Prior to now, the absence of study discovered the issue of how social media influences how trust, culture, and technology readiness interact with one another to get ready for smart tourism.

## **LITERATURE REVIEW**

### **SMART TOURISM**

When other observable factors affect a variable, it is said to be dependent in research. These variables should alter as a result of modifying the experiment's independent variable(s). In the context of this study, the dependent variable is smart tourism. Smart tourism is viewed as an innovative approach to fostering the development of the country's tourism industry while upholding Islamic principles, culture, and values. It should be noted that tourism, as defined in this study, does not solely encompass visits to mosques or pilgrimages, but rather it encompasses a journey that integrates Islamic ideals with nature, culture, or innovation. The tourism industry is financially lucrative, supported by a wide range of amenities and services provided by the local community, business owners, as well as federal and local governments. The

term "smart tourism" is commonly used to describe this approach, as it encompasses various tourism-related services, culinary experiences, beverages, attractions, and travel destinations, as long as they align with moral and ethical values.

## **TRUST**

The adage "seeing is believing" emphasizes the importance of trust in the tourism sector. Customers often rely on tangible evidence to build trust and make informed decisions about their travel experiences. In the context of smart tourism, trust becomes a crucial factor in ensuring customer satisfaction and loyalty.

Community engagement is another key aspect that contributes to building trust in smart tourism. Engaging with local communities and involving them in tourism development initiatives can foster a sense of ownership and shared responsibility. It can involve working with local businesses, artisans, and cultural organizations to showcase their products and traditions. By supporting local economies and empowering communities, destinations create a positive image and build trust among customers who appreciate authentic and immersive experiences.

Providing accurate and up-to-date travel information is essential for establishing trust in the smart tourism industry. Smart tourism apps play a crucial role in delivering relevant and reliable information to customers. This can include details about attractions, accommodations, transportation options, safety guidelines, and cultural insights. By ensuring that the information provided through smart tourism apps is comprehensive, accurate, and easily accessible, destinations can enhance customer trust and satisfaction.

The goal of smart tourism apps is to provide customers with exceptional services and enriching experiences. These apps leverage technology to offer personalized recommendations, real-time updates, interactive maps, and convenient booking features. By utilizing smart tourism apps, customers can access a wide range of services and experiences tailored to their preferences and needs. This enhances their overall travel experience and fosters a sense of trust and satisfaction in the destination.

## **CULTURE**

Tourism provides a unique context for studying cultural production due to its inherent nature of exposing individuals to different societies, cultures, and customs. Traveling offers countless opportunities for people to gain knowledge and firsthand experiences of diverse cultural practices, traditions, and heritage.

The World Tourism Organisation (WTO) broadened the definition of cultural tourism in 1985. According to this definition, cultural tourism encompasses the movement of people who have a desire for diversity and seek to increase their cultural understanding and experiences. It involves engaging with different cultures, acquiring new information, and having meaningful encounters with people from different backgrounds.

Cultural tourism goes beyond mere sightseeing and involves immersive experiences that allow travellers to interact with local communities, participate in cultural activities, visit historical sites, explore museums, attend cultural events, and engage in cultural exchanges. These experiences not only provide tourists with a deeper understanding of the cultural fabric of a destination but also contribute to personal growth, learning, and the acquisition of new perspectives.

By studying cultural production within the tourism context, researchers and practitioners can examine how cultural heritage is presented, interpreted, and commodified for tourist consumption. This includes researching how tourists enjoy cultural performances, arts and crafts, cuisine, music, dance, and other kinds of cultural expression.

Understanding the dynamics of cultural production in tourism can help destinations and stakeholders effectively manage and promote their cultural assets, preserve cultural heritage, and ensure sustainable tourism development. It also allows for the creation of authentic and enriching tourism experiences that respect and celebrate the diversity and uniqueness of different cultures.

In summary, tourism serves as an ideal setting for studying cultural production due to its role in facilitating cultural exchanges, providing opportunities for learning and personal growth, and promoting the

understanding and appreciation of diverse cultures. Researchers and practitioners can contribute to the development of sustainable and meaningful cultural tourism experiences by investigating the nature of cultural production in tourism.

## **TECHNOLOGY READINESS**

The use of technology has had a significant impact on numerous market operations in the tourism sector. The way information is accessed and disseminated has changed significantly. Travellers today have easy access to a great quantity of information about destinations, lodgings, activities, and transportation alternatives thanks to the internet and smart devices. This accessibility has empowered travellers to research, plan, and make informed decisions, thereby reshaping the way they interact with the industry.

Additionally, technology has revolutionized the booking and reservation process. Online travel agencies, booking platforms, and mobile apps have made it convenient for travellers to search for and book flights, accommodations, and other travel services with just a few clicks. This has streamlined the booking process, improved efficiency, and enhanced the overall customer experience.

However, alongside the opportunities, the integration of technology also presents challenges for the travel and hospitality industries. The rapid advancement of technology requires businesses to constantly adapt and keep pace with changing consumer behaviours and preferences. This may involve investing in new technologies, training staff, and ensuring cybersecurity measures are in place to protect customer data.

### **Research Hypothesis**

The hypothesis in the study to summarize the research question of how to determine, evaluate and identify the relationships between the independent variables and dependent variables **H 1:** Trust Has A Negative Impact On Smart Tourism.

**H 2:** Culture Have A Negative Impact On Smart Tourism.

**H 3:** Technology Readiness Has A Negative Impact On Smart Tourism.

### **Research Framework**

The independent variable is the problem of elements influencing a memorable tourist experience and Smart Tourism behavioural goals. Three independent variables that influence the dependent variable, Smart Tourism are Trust, Culture, and Technology Readiness. Figure 2.1 shows these variables.

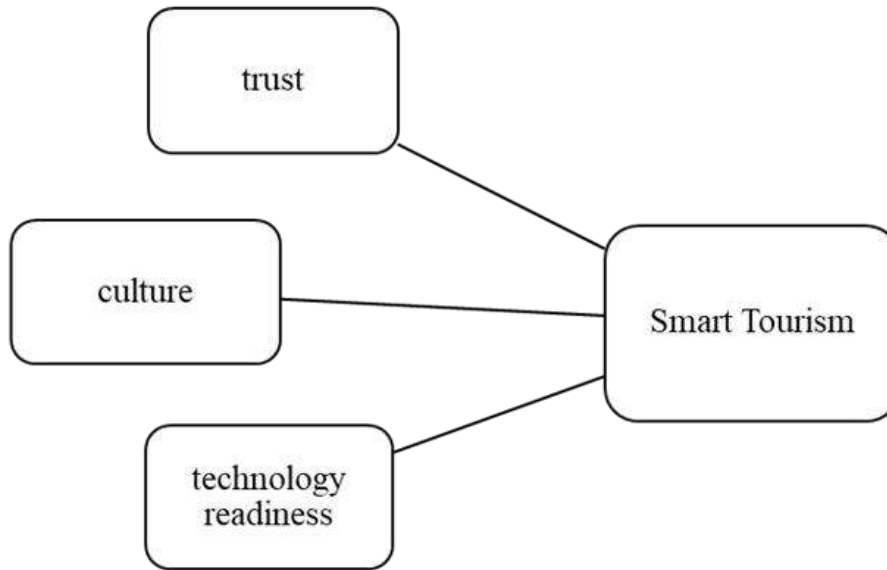

Figure 2.1: Conceptual Framework of Trust, Culture, Technology Readiness towards the Smart Tourism.

## METHODOLOGY

### Research Design

This study included causal, exploratory, and descriptive designs, all of which were quantitative techniques. Causation analysis will be used in this inquiry. This form of research tries to ascertain how a relationship between a dependent variable and an independent variable affects present norms and assumptions. A cross-sectional design is used in this investigation. Cross-sectional designs have the benefit that they concentrate on obtaining data at and around a certain period and finding connections between variables at that time. Since survey methods are quick and affordable data gathering methods, they are frequently used in cross-sectional designs.

An individual is used as the study's analytical unit. Surveys are without a doubt the most feasible method for gathering quantitative data. Self-administered surveys are a low-cost method for rapidly gathering a lot of information from a lot of individuals in a short amount of time without having to hire assessors to do in-person interviews. Therefore, self-administered questionnaires were used to collect the data for this investigation.

### Population and Sample Size

Overall, there are 66 million people in Malaysia's target market, including domestic visitors. This study only includes local tourists in Malaysia as its research population. In this study, sample size calculations were made using a table based on Krejcie & Morgan (1970) for a specific demographic. By Krejcie and Morgan in 1970:

S = sample size

$X^2$  = the chi-square value for 1 degree of freedom in the table at the acceptable level of confidence (3.841)

N = the annual population of domestic tourists

P = the fraction of the population (assumed to be 0.5 because it would yield the largest sample size)

$$\begin{aligned}
d &= \text{the proportional representation of the accuracy level (0.5)} \\
&= \frac{x^2NP(1-P)}{d^2(N-1)+(x^2P(1-P))} \\
&= \frac{3.841(205400000)(0.5)(1-0.5)}{(0.05)^2(205400000-1)+3.841(0.5)((1-0.5))} \\
&= \frac{197235300}{5135000.958} \\
&= 384.099 \\
&= 384
\end{aligned}$$

The precise sample size for the population is 384, but only 100 respondents' responses to the questionnaire were collected for data.

## Data Collection

For this study, a survey will be conducted using a self-administered research questionnaire. Respondents will serve as data collectors. This method is cost-effective, standardised, and allows for a large number of participants. A pilot study with 30 respondents, including students, private or government employees, and self-employed and retired people around Malaysia will be conducted to determine feasibility and select optimal approaches. Following the pilot study, a field study or actual surveys will be conducted.

## Sampling

The process of selecting representative samples from a population for research is called sampling. Probability sampling and non-probability sampling are the two types of sampling. In qualitative research, non-probability sampling—which is subject to the researcher's judgment—is widely employed. Convenience sampling, sequential sampling, quota sampling, judgemental or deliberate sampling, and snowball sampling are a few examples of different forms of sampling. Non-probability sampling approaches, in particular convenience sampling, are utilised in this study to save time and money while collecting a representative sample of the community. It is a convenient and inexpensive way to obtain information. To swiftly gather data while ensuring that the sample was representative, non-probability sampling, namely convenience sampling, was utilised in this study. Despite its limitations in terms of representativeness, this sampling strategy allows for speedy data collection and can provide significant insights in the context of the study's aims.

## Research Instrument

The questions used to assess the specified research constructs were drawn from previous studies on traveller behaviour.

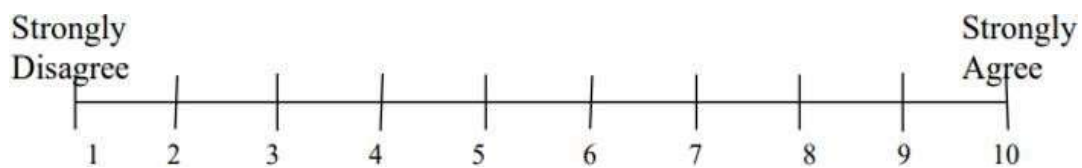

Figure 2: Measurement of Likert scale

## Data Analysis

Descriptive statistics describe the basic characteristics of data, providing summaries of the sample and measurements. Data analysis aims to extract useful information from data for decision-making. Descriptive

statistics describe the data itself, while inferential statistics make deductions and inferences beyond the available facts. This study aims to analyze international visitor data in Malaysia, explore effective tourism strategies, and understand visitor behaviour. The study utilizes visitor data from the Malaysia Tourist Information Center, considering Malaysia's geographic location as an appealing transit point for international travellers. To maximize tourism development, the focus should be on natural, cultural, and shopping attractions.

In this study, the objective is to analyze international visitor data in Malaysia and explore effective tourism strategies while gaining insights into visitor behaviour. To achieve this, data from the Malaysia Tourist Information Center, which serves as a reliable source of visitor information, is utilized. Malaysia's strategic geographic location as a transit point for international travellers adds significance to the study, as it offers opportunities to attract and cater to a diverse range of visitors.

The analysis of visitor data aims to uncover patterns, preferences, and trends among international travellers, which can inform the development of effective tourism strategies. By focusing on natural, cultural, and shopping attractions, the study aims to capitalize on Malaysia's unique offerings and enhance tourism development.

By utilizing both descriptive and inferential statistics, this study strives to provide valuable insights and recommendations for the tourism industry in Malaysia. The analysis of visitor data and the exploration of effective strategies can contribute to enhancing the overall tourism experience and supporting sustainable tourism growth in the country.

## FINDINGS

The collected data was analyzed using PLS (Partial Least Squares) and SPSS version 20.0. This approach allowed for the examination of research metrics, competencies, and dependent variables in the context of the Pakistani cultural setting. Previous studies conducted in culturally distinct Western nations, such as the Netherlands, have demonstrated the effectiveness of service innovation (Janssen, Castaldi, & Alexiev, 2015). A discriminant validity analysis was also undertaken to improve the validity of the psychometric assessment. To test the hypotheses in this study, regression-based process analysis, as described by Hayes (2017), was utilized. This analytical approach allows for a comprehensive examination of the relationships and interactions between variables, providing valuable insights into the research findings.

The study attempts to contribute to the understanding of the research topic in the specific cultural context of Pakistan by applying these analytical tools and procedures. The outcomes of this analysis are expected to improve the knowledge base surrounding the research topic and provide significant insights for future studies.

**Table 1: Summary of Demographic Profile**

Demographic	Categories	Frequency (N)	Percentage (%)
-------------	------------	---------------	----------------



<b>Gender</b>	Male	73	73%
	Female	27	27%
<b>Age</b>	18 – 23 years old	54	54%
	24 – 29 years old	21	21%
	30 – 36 years old	13	13%
	37 – 42 years old	7	7%
	42 years old above	5	5%
<b>Race</b>	Malay	53	53%
	Chinese	31	31%
	Indian	13	13%
	Others	3	3%
<b>Education Level</b>	Secondary / Primary School	9	9%
	Certificate/Diploma	17	17%
	Bachelor's Degree	64	64%
	Master's Degree Ph.D.	8	8%
		2	2%

<b>Employment Status</b>			
	Student	64	13.8
	Self-Employed	6	21.6
	Private Sector Worker	16	18.5
	Government Sector Worker	10	45.8
	Retired	4	0.3

Based on the data presented in Table 1, the respondents' characteristics can be summarized as follows. In terms of gender distribution, out of the 100 respondents, 73% were female, while 27% were male.

In terms of age, the largest group of respondents, accounting for 54%, were between the ages of 18 and 23. The second-largest age group, with 21% of respondents, was those aged 22 to 29. The remaining age groups were 30-36 years old (13%), 37-42 years old (7%), and 42 years and older (5%).

In terms of race, the highest participation rate was among the Malay respondents, constituting 53% of the sample. Chinese respondents accounted for 31% , followed by Indians at 13% . Other racial groups represented 3% of the respondents.

In terms of education, the majority of respondents (64%), possessed a bachelor's degree. Certificate/diploma holders had the second highest educational level, accounting for 17% of respondents. Secondary/primary school students made up 9% of the sample, with master's degree holders accounting for 8% and PhD holders accounting for 2%.

In terms of employment status, the largest occupation category was students, representing 64% of the respondents. Private sector workers accounted for 16% , while government sector workers constituted 10% of the sample. Self-employed individuals represented 6% of respondents, and 4% were retired.

Overall, this information provides an overview of the gender, age, race, education level, and employment status of the respondents in the study.

## Descriptive Analysis

Table 2: Descriptive Statistics

<b>Variables</b>	<b>N</b>	<b>Mean</b>	<b>Standard Deviation</b>
Smart Tourism	100	6.7890	1.69790
Trust	100	6.9685	1.63014
Culture	100	6.8880	1.71720
Technology Readiness	100	7.0628	1.65471

The mean and standard deviation analysis for the independent and dependent variables is shown in Table 2. The dependent variable was the Smart Tourism in Malaysia. Trust, Culture, and Technology Readiness were independent variables. Technology had the highest mean score, 7.0628, indicating that respondents were more in agreement with this characteristic. The variable with the lowest mean value in this study's respondents' agreement was Smart Tourism, which has a value of just 6.7890. The data set that has more dispensing values has a standard deviation of more than 1 out of 100 respondents.

**Table 3: Reliability Analysis Result**

Construct	Cronbach's Alpha	No of Item	N
Smart Tourism	0.914	11	100
Trust	0.897	7	100
Culture	0.890	6	100
Technology Readiness	0.913	7	100
<b>All Variable</b>	<b>0.904</b>	<b>31</b>	<b>100</b>

The test-retest reliability can be calculated by comparing the scores or responses from the first administration with those from the second administration. Statistical measures like correlation coefficients, such as Pearson's correlation or intraclass correlation, can also be used to determine the degree of agreement or consistency between the two sets of scores.

For example, a high correlation coefficient, such as 0.80 or above, indicates strong test-retest reliability, suggesting that the questionnaire produces consistent results over time. Conversely, a low correlation coefficient, below 0.50, suggests poor test-retest reliability, indicating that the questionnaire may not be consistent or stable over time.

By conducting a test-retest reliability study, researchers can evaluate whether the measurement instrument produces consistent results over time and determine if any modifications or improvements are necessary to enhance its reliability.

### Pearson Correlation Hypothesis 1

H<sub>1</sub>: There is a significant relationship between trust and smart tourism among tourism stakeholders in Malaysia.

Table 4: Correlation coefficient for trust and smart tourism among tourists in Malaysia

		Trust	Smart Tourism
<b>Trust</b>	Pearson Correlation	1	.744**
	Sig. (2-tailed)		.000
	N	100	100
<b>Smart Tourism</b>	Pearson Correlation	.744**	1

	Sig. (2-tailed)	.000	
	N	100	100

Table 4 showed the strong correlation (0.744) between trust and smart tourism among Malaysian tourist stakeholders. Significance value for trust is 0.000 (< 0.001 threshold), indicating a significant relationship. Supports H1.

## Hypothesis 2

H<sub>2</sub>: There is a significant relationship between culture and smart tourism among tourism stakeholders in Malaysia.

Table 5: Correlation coefficient for culture and smart tourism among tourists stakeholder in Malaysia

		Culture	Smart Tourism
Culture	Pearson Correlation	1	.704**
	Sig. (2-tailed)		<.000
	N	100	100
Smart Tourism	Pearson Correlation	.704**	1
	Sig. (2-tailed)	.000	
	N	100	100

Table 5 showed the moderate correlation (0.704) between culture and smart tourism among Malaysian tourism stakeholders. Significance value for trust is 0.000 (< 0.001 threshold), indicating a significant relationship. Supports H2.

## Hypothesis 3

H<sub>3</sub>: There is a significant relationship between technology readiness and smart tourism among tourism stakeholders in Malaysia.

Table 6: Correlation coefficient for technology readiness and smart tourism among tourists in Malaysia

		Technology Readiness	Smart Tourism
Technology Readiness	Pearson Correlation	1	.684
	Sig. (2-tailed)		.000
	N	100	100
Smart Tourism	Pearson Correlation	.684	1
	Sig. (2-tailed)	.000	

Table 6 showed the moderate correlation (0.684) between technology readiness and smart tourism among Malaysian tourism stakeholders. Significance value for technology readiness is 0.000 ( $< 0.001$  threshold), indicating a significant relationship.

Table 7: Summary of Correlation Analysis

Hypothesis	Significant Value	Conclusion	Correlation Value	Conclusion
1	0.000	Accepted	0.744	High Positive Correlation
2	0.000	Accepted	0.704	High Positive Correlation
3	0.000	Accepted	0.684	High Positive Correlation

## DISCUSSION AND RECOMMENDATION

The study's findings provide vital advice for Malaysian practitioners working in the subject of smart tourism. The findings suggest that improving trust, culture, and technological preparedness within organisations can greatly contribute to these enterprises' development, growth, and resilience in providing distinctive services.

Malaysia should prioritise the building of a welcoming and responsive environment in order to exploit the potential of social media in the travel and tourism business. This entails actively engaging with social media platforms and utilizing them as effective marketing tools. By actively participating in social media activities, tourism practitioners can enhance their online presence, engage with a larger target audience, and build strong relationships with potential tourists.

Furthermore, the study highlights the importance of actively seeking out innovative ideas. Managers should encourage a culture of openness and acceptance towards fresh suggestions and novel concepts. This will create an environment where innovative ideas can thrive without facing unnecessary resistance. Managers and employees should be encouraged to explore and experiment with new methods and approaches to stay competitive and adapt to changing market demands.

By following these recommendations, Malaysian smart tourism practitioners can enhance their competitiveness, deliver unique and personalized services, and keep pace with the evolving needs and preferences of tourists. Embracing trust, culture, and technological readiness, along with a focus on innovation, will position Malaysia as a dynamic and attractive destination in the global tourism landscape.

There are several restrictions on this study that may help open up new research directions. This paper focuses solely on the smart tourism sector as the leader in service innovation; however, market and educational issues are not addressed. It is suggested that a future study look at its impact. Future study on the impact of social media on technological preparedness Intelligent tourism is still a possibility. Examine the function of social media tactics, such as online knowledge marketplaces. Additionally, investigate further the potential effects of smart tourism on service quality or client happiness. Additionally, it offers crucial guidelines for brandnew study. Additionally, this work has undergone measurement and verification concepts of trustworthy travel, cultural and technical preparation, and the effects of social media only apply to Malaysia. The industry is largely in agreement and is aware of the notion of variables, but more empirical study on digital marketing and tourism in various economies is required.

## CONCLUSION

In summary, the purpose of this study was to investigate the factors impacting the use of smart tourism apps among Malaysian tourism stakeholders. The study identified trust, culture, and technology readiness as key independent variables that significantly impact the adoption and usage of smart tourism among Malaysia's tourism stakeholders. These variables play a crucial role in shaping the behaviour and decision-making processes of stakeholders when it comes to using smart tourism apps.

All of the hypotheses (H1, H2, and H3) suggested in the study were supported by the analysis and findings. This suggests that trust, culture, and technological readiness all have a substantial positive impact on Malaysia's tourism stakeholders' acceptance and utilisation of smart tourism apps.

However, it is critical to recognise the research's limitations. The use of a specific sample size and sampling technique, which may not fully represent the whole population of Malaysian tourism stakeholders, is one restriction. Additionally, the study focused on specific aspects of trust, culture, and technology readiness, and there may be other factors that could also impact the use of smart tourism apps.

Given these constraints, it is suggested that future study in this area examine a bigger and more diverse sample in order to gain a more full understanding of the factors impacting smart tourism app usage. Additionally, future studies could delve deeper into other factors that may influence smart tourism adoption, such as government policies, marketing strategies, and user experiences.

Finally, this study gives useful insights into the factors influencing the use of smart tourism apps among Malaysia's tourist stakeholders. Understanding the importance of trust, culture, and technology preparedness allows stakeholders to make educated decisions and strategies to improve the acceptance and utilisation of smart tourism, ultimately contributing to the growth and development of Malaysia's tourism business.

## REFERENCES

- Akter, M., Sadekin, M. N., & Patwary, A. K. (2020). An Empirical Study on Students' Satisfaction from Mawlana Bhashani Science & Technology University, Bangladesh. *Review of Economics and Development Studies*, 6(2), 363-379.
- Al Mahmud, S. R. (2020). The effectiveness of Facebook advertisements on purchase intention of customers in Malaysia. *South Asian Journal of Social Sciences and Humanities*, 1(1), 97-104.
- Alom, S., Patwary, A. K., & Khan, M. M. H. (2019). Factors affecting the turnover intention of Bangladeshi migrants in the United Arab Emirates: An empirical study on the hotel industry. *International Journal of Innovation, Creativity and Change*, 8(3), 344-360.
- Amadebai, E. (2022, July 10). Sampling Techniques: Definition, Types, And Examples | AnalyticsForDecisions. Analytics for Decisions. <https://www.analyticsfordecisions.com/sampling-techniques-definition-types-and-examples/>
- Chaffey, D., & Ellis-Chadwick, F. (2019). *Digital marketing*. Pearson UK.
- Cheuk, S. C. S., Atang, A., Lo, M. C., & Ramayah, T. (2017). Community Perceptions on the Usage of Digital Marketing for Homestays: The Case of Ba'kelalan, Malaysia. *International Journal of Business and Society*, 18(S4), 775-782.
- Cultural tourism explained: What, why and where - Tourism Teacher (2022). (2022, December 1). Subhrankurretail. <https://subhrankurretail-com.ngontinh24.com/article/cultural-tourismexplained-what-why-and-where-tourism-teacher>
- Fengmin, Z., Baijun, W., Jiangtao, B., Li, L., & Patwary, A. K. (2022). Investigating revisit intention of medical tourists in China through nutritional knowledge, perceived medical quality, and trust in the physiologist: A recommendation on health tourism policy measures. *Frontiers in Public Health*, 10, 893497.
- Fleetwood, D. (2018b, April 30). Non-Probability Sampling: Types, Examples, & Advantages. QuestionPro. <https://www.questionpro.com/blog/non-probability-sampling/>
- Fleetwood, D. (2018, March 13). Probability sampling: What it is, Examples & Steps. QuestionPro. <https://www.questionpro.com/blog/probability-sampling/>
- Hassan, H., Omar, S. I., & Ahmad, G. (2020). IMPORTANCE-PERFORMANCE MATRIX ANALYSIS OF KOTA BHARU'S ISLAMIC CITY IMAGE. *PLANNING MALAYSIA*, 18(13). <https://doi.org/10.21837/pm.v18i13.781>

- Hazbar, A. M. H., Alem Mohammed, A., & Karim, A. K. A. (2019). An Empirical Study of Factors Influencing hotel customers' online booking Intention. *مجلة العلوم التربوية و الدراسات الإنسانية*, (5), 1-17.
- How to Identify a Dependent Variable. (2022b, November 8). Verywell Mind. <https://www.verywellmind.com/what-is-a-dependent-variable-2795099>
- Janssen, M., Castaldi, C., Alexiev, A., & Den Hertog, P. (2015). Exploring a multidimensional approach to service innovation. In *The Handbook of Service Innovation* (pp. 91-108). Springer, London
- Kalaiya, A. B., & Kumar, A. (2015). Tourism as a development tool: A study on role of tourism in economic development, employment generation and poverty reduction: Special focus on Kachchh. *International Journal*, 3(7), 189-197.
- Karjaluoto, H., Mustonen, N., & Ulkuniemi, P. (2015). The role of digital channels in industrial marketing communications. *Journal of Business & Industrial Marketing*, 30(6), 703-710.
- Kiráľová, A., & Pavlíčka, A. (2015). Development of social media strategies in tourism destination. *Procedia-Social and Behavioral Sciences*, 175, 358-366.
- Koens, K., & Thomas, R. (2015). Is small beautiful? Understanding the contribution of small businesses in township tourism to economic development. *Development Southern Africa*, 32(3), 320- 332.
- Kourouthanassis, P. E., Mikalef, P., Pappas, I. O., & Kostagiolas, P. (2017). Explaining travellers online information satisfaction: A complexity theory approach on information needs, barriers, sources and personal characteristics. *Information & Management*, 54(6), 814-824.
- Ku, E. C., & Chen, C. D. (2015). Cultivating travellers' revisit intention to e-tourism service: the moderating effect of website interactivity. *Behaviour & Information Technology*, 34(5), 465-478.
- Kulshrestha, R. (2019). Smart Tourism Marketing Through Smart Phones: The Case of Uttar Pradesh. *Emerging Trends in Indian Tourism and Hospitality: Transformation and Innovation*, 25.
- Laudon, K. C., & Traver, C. G. (2016). *E-commerce: business, technology, society*.
- Lee, S., Nguyen, H. N., Lee, K. S., Chua, B. L., & Han, H. (2018). Price, people, location, culture and reputation: determinants of Malaysia as study destination by international hospitality and tourism undergraduates. *Journal of Tourism and Cultural Change*, 16(4), 335-347.
- Li, L., Ragavan, N. A., Patwary, A. K., & Baijun, W. (2022). Measuring patients' satisfaction toward health tourism in Malaysia through hospital environment, nutritional advice, and perceived value: A study on Chinese exchange students. *Frontiers in public health*, 10, 893439.
- Li, L., Wu, B., & Patwary, A. K. (2022). How marine tourism promote financial development in sustainable economy: new evidences from South Asia and implications to future tourism students. *Environmental Science and Pollution Research*, 29, 1155-1172.
- Li, L., Wu, B., & Patwary, A. K. (2022). The psychosocial factors affecting chinese Outbound Exchange and mobility students' academic performance during COVID-19. *Frontiers in psychology*, 13, 872516.
- Mariani, M. M., Di Felice, M., & Mura, M. (2016). Facebook as a destination marketing tool: Evidence from Italian regional Destination Management Organizations. *Tourism Management*, 54, 321-343.

- Memon, M. A., Ting, H., Cheah, J. H., Thurasamy, R., Chuah, F., & Cham, T. H. (2020). Sample Ming Zhang, (2005). Exploring the Relationship between Urban, Form and Non-work Travel through Time Use Analysis. *Landscape and Urban Planning*, Vol. 173, No. 3, pp. 244-261. <https://journals.sagepub.com/doi/full/10.1177/0739456X17711516>
- Moghavvemi, S., Ormond, M., Musa, G., Isa, C. R. M., Thirumoorthi, T., Mustapha, M. Z. B., & Chandy, J. J. C. (2017). Connecting with prospective medical tourists online: A cross-sectional analysis of private hospital websites promoting medical tourism in India, Malaysia and Thailand. *Tourism Management*, 58, 154-163.
- Muslim traveler | | planning your journey [official] Japan's national tourism administration (JNTO) <https://www.japan-travel.cn/plan/muslim-travelers> | planning your trip | [official] Japan's national tourism administration (JNTO)
- Okazaki, S., Andreu, L., & Campo, S. (2017). Knowledge sharing among tourists via social media: a comparison between Facebook and TripAdvisor. *International Journal of Tourism Research*, 19(1), 107-119.
- Osborne, S., & Williams, J. (2016). US Travel and Tourism Satellite Accounts for 2013–2015, Survey of Current Business, 1-5.
- Parveen, Huma & Showkat, Nayeem. (2017). Data Collection. [https://www.researchgate.net/publication/319128325\\_Data\\_Collection](https://www.researchgate.net/publication/319128325_Data_Collection)
- Patwary, A. K., Roy, B., Hoque, R., & Khandakar, M. S. A. (2019). Process of developing a community based tourism and identifying its economic and social impacts: An Empirical study on Cox's Bazar, Bangladesh. *Pakistan Journal of Humanities and Social Sciences*, 7(1), 1-13.
- Razli, I. A., Jamal, S. A., & Zahari, M. S. M. (2017). Airbnb: An overview of a new platform for peer to peer accommodation in Malaysia. *Advanced Science Letters*, 23(8), 7829-7832.
- Research Guides: Organizing Your Social Sciences Research Paper: Independent and Dependent Variables. (n.d.). <https://libguides.usc.edu/writingguide/variables>
- Rodrigo A. O. & Oscar A. S., (2007). Determination of Management Zones in Corn (zea mays L.) based on Soil Fertility. *Computers and Electronics in Agriculture*, Vol. 58, No. 1, pp. 49-59. <https://dl.acm.org/doi/abs/10.1016/j.compag.2006.12.011>
- Ryan, D. (2016). Understanding digital marketing: marketing strategies for engaging the digital generation. Kogan Page Publishers.
- Shafaei, F., & Mohamed, B. (2017). Malaysia's branding as an Islamic tourism hub: An assessment. *Geografia-Malaysian Journal of Society and Space*, 11(1).
- Size for Survey Research: Review and Recommendations. *Journal of Applied Structural Equation Modeling*, 4(2), i-xx. [https://doi.org/10.47263/jasem.4\(2\)01](https://doi.org/10.47263/jasem.4(2)01)
- Song, H. & Li, G., (2008). Tourism demand and forecasting: A review of recent research. *Tourism Management*, Vol. 29, No. 2, pp. 203-220. <https://scirp.org/reference/referencespapers.aspx?referenceid=249720>
- Sumethokula, P., Patwary, A. K., Srinuanpanc, B., Srinuanpand, C., Suwandee, P., Thammathikul, A., & Phanong, W. (2020). The potential of new tour repackaging for creative tourism among entrepreneurs in Nakhon Si Thammarat. *International Journal of Innovation, Creativity and Change*, 13(10), 1752-1771.



- Sun, P., Cárdenas, D. A., & Harrill, R. (2016). Chinese customers' evaluation of travel website quality: A decision-tree analysis. *Journal of Hospitality Marketing & Management*, 25(4), 476497.
- Travel & Tourism Economic Impact | World Travel & Tourism Council (WTTC). (n.d.). <https://wttc.org/research/economic-impact>
- Trunfio, M., & Della Lucia, M. (2017). Toward Web 5.0 in Italian regional destination marketing. *Symphonya. Emerging Issues in Management*, (2), 60-75.
- TRUST in tourism: How to build and maintain consumer trust - University of Victoria. (n.d.). <https://www.uvic.ca/gustavson/brandtrust/about/commentarysaul/trust-in-tourism/index.php>
- Van Riel, A. C., Lemmink, J., & Ouwersloot, H. (2004). High-technology service innovation success: a decision-making perspective. *Journal of Product Innovation Management*, 21(5), 348359.
- Veal, A. J. (2017). *Research methods for leisure and tourism*. Pearson UK.
- Wang, Y., So, K. K. F., & Sparks, B. A. (2017). Technology readiness and customer satisfaction with travel technologies: A cross-country investigation. *Journal of Travel Research*, 56(5), 563577.
- Wu, B., Liu, S., Wang, J., Tahir, S., & Patwary, A. K. (2021). Assessing the mechanism of energy efficiency and energy poverty alleviation based on environmental regulation policy measures. *Environmental Science and Pollution Research*, 28, 40858-40870.
- Wu, B., Zhai, B., Mu, H., Peng, X., Wang, C., & Patwary, A. K. (2021). Evaluating an economic application of renewable generated hydrogen: A way forward for green economic performance and policy measures. *Environmental Science and Pollution Research*, 1-15.
- Xiang, Z., Magnini, V. P., & Fesenmaier, D. R. (2015). Information technology and consumer behavior in travel and tourism: Insights from travel planning using the internet. *Journal of Retailing and Consumer Services*, 22, 244-249.
- Zhaldak, G., & Shulgina, L. (2016). Prospects of implementation and practice compliance with marketing standards in Ukraine and the EU. *Вісник Національного університету Львівська політехніка. Логістика*, (848), 123-131.

# **A Study of Tourist Satisfaction of Cross-Border Tourism Development in Rantau Panjang, Kelantan**

**Trissa Anak Bunyau, Tuan Zulaikha Binti Tuan Rusli, Thurgadewi A/P Givanatha, & Thanusha A/P Rajamurthi**

**\*Puan Siti Selihah Binti Che Hasan**

*Faculty of Hospitality, Tourism and Wellness, University Malaysia Kelantan*

*Corresponding email: h20a1844@siswa.umk.edu.my*

## **Abstract**

*The determination of this study is to investigate the connection between influencing factors and tourist satisfaction with the growth of cross-border tourism in Rantau Panjang. The main objective of this study is to determine what influences tourists' satisfaction with the growing cross-border tourism industry in Rantau Panjang. A total of 378 successfully founded respondents were questioned via the online survey regarding the 5.5 million local tourists who were targeted to visit Rantau Panjang, Kelantan, in 2021. Version 29.0 of the Statistical Package for Social Science (SPSS) was used for data collection and analysis. The findings indicate a strong correlation between tourist perception, infrastructure issues, destination image, and tourist satisfaction with the cross-border tourism development in Rantau Panjang. Through this study, one can gain a deeper comprehension of the influences on tourist satisfaction of cross-border tourism development in Rantau Panjang.*

**Keywords:** Tourist perception, infrastructure issues, destination image, tourist satisfaction.

## **INTRODUCTION**

In chapter one of this research, we discuss the problem statement, research purpose, research question, significance of the study, and definition of terminology, and the chapter concludes with a summary. Especially in tourist areas, the tourism industry plays an important role in the economic growth and revenue of the nation. One element that contributes to the attractiveness of an area as a tourist destination is the shape of the local topography. Local culture is an important factor in a region's attractiveness to tourists. Every year, more tourists visit Malaysia and make it their favourite destination, especially in Rantau Panjang, Kelantan. This is because travellers to Kelantan use Rantau Panjang as a commercial and shopping center. In the tourism industry, "visitor pleasure is highly correlated with both visitor safety and visitor culture". Manson, (2008). Tourists are people who use commercial services to travel outside of their own country to find leisure, relaxation, and pleasure. The tourism industry is "a by product of the modern social systems that appeared in the 17th year, although its roots lie in classical antiquity". The difference between tourism and exploration is that tourists take the "beaten path," kind of from established service systems, and, as befits pleasure seekers, are often shielded from hardship, danger, and embarrassment. Tourism and other endeavors, procedures, and activities, such as pilgrimage, do, nonetheless, have certain similarities. The objective of this study is to find the relationship between tourist perception, infrastructure issues, destination image and tourist satisfaction of cross-border tourism development in Rantau Panjang.

## **Significance of the Study**

This research is based on a study of tourist satisfaction of cross-border tourism development in Rantau Panjang. It is for this reason that this research will ease the degree of magnitude, seriousness, and intensity of the issue being studied. These are one realization that have been made since no research on tourism part analysis to discuss the feasibility of establishing the Rantau Panjang (Kelantan/Malaysia). Based on the researcher's research, more tourists might get more enjoyment in cross-border tourism development. The corporation will have the learning what are the challenges facing these on an in-between-borders level in cross-border tourism collaborations. While conducting this study, the researcher will also be

able to increase their regulation, knowledge, and exposure in the research field. In cross-border tourism partnerships, the relationship between the researcher and the traveler is established at each part during the distribution portion of the questionnaire.

In addition, the results of this study may provide the tourist industry with an opportunity to learn useful information on how to get around the difficulties associated with the growth of international tourism. The finding will also help the tourism organizations to enlarge the development and upgrade cross-border tourism and also fascinate more tourists from other states as well as fulfilling the needs of tourists.

At long last, the institution will ultimately benefit from conducting quality research in a number of ways. Establishing a solid reputation for future scientists who might choose to direct their research toward the growth of international travel. They might obtain a lot more specific information that is pertinent to the study using the already collected data. In addition, it might provide aid to a young researcher and a recent corpus of knowledge.

## LITERATURE REVIEW

A type of educational writing known as a literature review exhibits knowledge and understanding of the pedagogical literature on a given subject in relation to other sources. A critical evaluation of the sources is also part of a literature review. This is due to the fact that a literature review is referred to as such rather than a literature report and because it is both an endeavor to discuss the literature and a type of writing.

This study discusses a number of studies by earlier scholars on smugglers and their impacts on the border economy. Schoenberger and Turner's (2008) "study looks at the cross-border trade networks that the Kinh, an ethnic minority in the highlands of northwestern Vietnam, and those in southwest China engage in". They discovered that through these commercial operations, access to the boundaries between the various societal elements is complicated, both in terms of domestic policy and the interactions between various ethnic groups in order to take advantage of economic opportunities.

Based on empirical data in post-socialist countries, Bruns et al. (2011) "offer their perspectives on the reasons behind small-scale, cross-border smuggling and trading operations". Even though such actions are prohibited by law, they may still take place because they have gained societal acceptance.

Most of the women participating in small-scale cross-border trade were between the ages of 20 and 40. This is because they are required to have more "economic clout in order to make judgments that could have an effect on their day-to-day life" (KOIS, 2011). Increased crossborder activity is a hallmark of the globalization of the international economy. Where a "number of scholars contend that state borders increasingly serve as porous barriers to allow cross-border contacts in business and society" (Dicken, 2000, Evans et al, 2000). But at the same time, modern borders serve as significant reminders of state authority over territorial boundaries and population shifts. In actuality, the market, globalization.

States have always played a significant role in determining cross-border flows of "goods and people, refuting the idea that our world has no borders" (Hirst and Thompson, 1995; Ohmae, 1990). State boundaries define the area over which a state exercises authority and serve as "inspection agents" to regulate what can be carried into a country between the lines of political jurisdiction. They make the case that borders should be given more "consideration in light of a number of contemporary issues, such as cross-border regions, the authority of governments, cultural landscapes, and the informal economy" (Donnan et al. and Wilson, 1994, 1999; Pavlakovich-Kochi et al., 2004; Newman, 2006).

Legislative field limits, according to Morehouse et al. (2004), "rarely reflect the reality of boundaries; rather, regional border zones and cultural landscapes are viewed from many angles". People communicate with borders, exchanges inside them, and interactions beyond limits all shape border identity. Since people near the border frequently seek practical ways to negotiate border restrictions and state laws, government efforts to create political and economic constraints for cross-border connections frequently can't totally control what happens on a daily basis.

More enforcement of the legislation against smuggling will increase the cost of commodities per unit and decrease the volume of imported goods that are smuggled" (Martin and Panagariya 1983). The actual cost of smuggled products per unit and domestic import prices will rise when anti-smuggling enforcement laws are

strengthened, but the amount and percentage of illegal imports relative to overall imports will decrease. Their model, however, is unable to account for how smuggling affects social welfare.

### **Tourist Perception**

Perception is a group of internal sensory cognitive processes that the brain uses to detect, relate, analyze, and search for internal cognitive information at the subconscious level of cognitive function. Whether a tourist has a favorable or unfavorable attitude towards anything is referred to as their tourist perception. It is also about the previous experience of tourists. This defines tourist perception as a tourist's evaluation of a particular thing. The development of cross-border travel is hampered by visitor perceptions. Significant elements impact tourists' perceptions. A traveler, for instance, might acquire an impression of a place based on its reputation for safety, natural attractions, entertainment value, and relaxation options, as well as the general travel environment. There is a wealth of information available to tourists that they can utilize to plan cross-border trips. Finally, it is evident why it is important to cultivate visitor perceptions from a variety of angles based on their travel preferences.

### **Infrastructure Issue**

The infrastructure of a nation, city, or other locale is the grouping of structures and mechanisms that offers the facilities and services necessary for the operation of its economy, households, and companies. Highways, trains, bridges, tunnels, water supply, sewage systems, electrical grids, and telephones are just a few examples of the public and private physical constructions that are regarded as being part of the infrastructure (which also includes Internet connectivity and broadband access).

### **Destination Image**

Both an attribute-based component and a holistic component may be taken into account while analyzing the destination image. Because of the significant roles that cross-border development is known to play in influencing destination choice, destination image is a subject that has received extensive attention in the literature on tourism development.

### **Cross-Border**

There are challenges associated with this influence in international travel, and there are some authors who have examined them within a tourism context. The second goal of this research is to examine the institutional challenges that cross-border tourism faces in Rantau Panjang, Kelantan. This section will go over them in greater detail. When the literature on tourist satisfaction of cross-border tourism development was examined, a rather distinct pattern emerged. The majority of tourist satisfaction are related to social, cultural, economic, political, and regulatory factors, as well as organization and governance. When these are arranged into a figure, clear themes of tourist satisfaction in cross-border tourism emerge.

### **Tourism Development**

The study of tourism development focused on the political, economic, social, cultural, and psychological effects of borders on tourism. The majority of the literature focuses on the opportunities and satisfaction associated with cross-border situations in tourist destinations. Furthermore, he is said to have made significant contributions to the study of borders and tourism, and much of the research in the field is based on his prolific contribution.

### **Research hypothesis**

The hypothesis is an assumption about the relationship between two or more variables that have not been proven. It is a detailed, testable hypothesis about what you expect a study to reveal. To give an example, the study's hypothesis might read, "This research is designed to value the hypothesis that sleep-deprived folks can perform lower on a test than individuals who are not sleep-deprived." Despite being a prophecy, the idea goes above and beyond typical speculation. Typically, the hypothesis begins with a query, which is then looked into through background research. Only now are scientists beginning to develop a testable hypothesis.

The framework makes it clear that every variable has a strong relationship with the others, which ultimately prompts the researcher to come up with three hypotheses as follows:

H1: There is a significant relationship between tourist perception and tourist satisfaction of cross-border tourism development in Rantau Panjang.

H2: There is a significant relationship between infrastructure issues and tourist satisfaction of cross-border tourism development in Rantau Panjang.

H3: There is a significant relationship between destination image and tourist satisfaction of cross-border tourism development in Rantau Panjang.

### Research framework

A conceptual framework is represented by the relationship you anticipate seeing between your variables or the qualities or properties that you wish to investigate. The “mass crucial knickknack comprehend with regard to your scheme is that it is first and foremost a fertilization or model of the things that are currently existing that you plan to study, as well as a clarification of what is incident in the company of them and purpose, as well as an unconfirmed proposition of the experience that you breath researching”. This thesis is in the service of escorting the other module of your representation, assisting you in checking something out and honing your holy grail, creating pertinent and realistic research questions, choosing the best techniques, and spotting any threats to the validity of your findings. The three factors that make up the independent variable that will be proposed are tourist perception, risk perception and destination image towards cross-border tourism development. Cross-border tourism development challenges facing Rantau Panjang is the dependent variable.

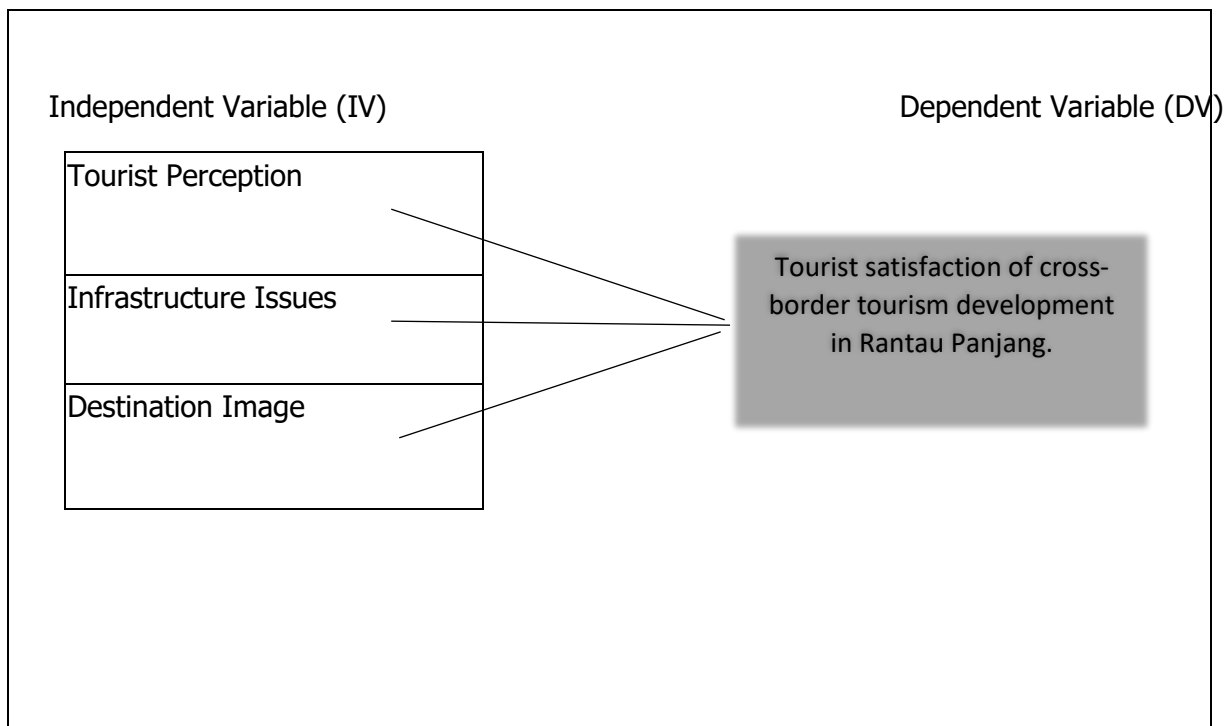

Figure 2.1: Conceptual framework of the relationship between tourist perception, infrastructure issues, and destination image in tourist satisfaction of cross-border tourism development in Rantau Panjang.

## **METHODOLOGY**

By choosing the best and most efficient means to conduct the study while adhering to the research purpose and goals, the methodology is utilized to solve research difficulties. The strategy includes providing answers to the what, why, and how of your investigation. The research technique discusses and explains the procedures used to gather and analyze data.

All the steps involved in the investigation are outlined in this chapter. All the components of this research's methodology are covered in this chapter, from the research design and population to the sample size and sampling method to the research instrument and data analysis. In-depth explanations of the chosen mode of analysis and the data-gathering technique are also provided in this chapter.

### **Research Design**

The research design acts as a broad method that you use to organize the many components of the research in a logical and cogent manner. Utilizing technical frameworks and procedures, “research design can combine the many research components to solve research challenges in a logical and effective manner” (Adi Bath, 2018). Researchers used quantitative research to gather data for this study. In quantitative research, “numbers and statistics are utilized to describe and evaluate results in order to find the relationship between variables” (Kumar, 2013). In order to comprehend and identify the relationship between the independent variables of tourist perception, risk perception, and destination image and the dependent variable, identifying hurdles to cross-border tourism growth in Rantau Panjang, quantitative research was used in this study. To gather data and determine the obstacles to an increase of cross-border tourism in Rantau Panjang, the researcher conducts a survey using a questionnaire.

Data collection is the process of gathering and measuring information on variables of interest in accordance with established, rigorous guidelines in order to respond to the research questions posed, test hypotheses, and evaluate results. Data collection is an efficient process for gathering and analyzing information from any of the sources in order to obtain complete and reliable data.

The primary method of data collecting is quantitative research, and real-time data is included. In quantitative research, statistics are generated by used techniques like structured questionnaires in large-scale surveys. Because it helps to boost the accuracy of the data obtained, the simple random sample method is employed in the primary data collection process. A questionnaire was also selected as the method since it allows for the quickest collection of data from respondents. The questionnaire consists of four sections matched in the dependent and independent variables. The responses are recorded for the research. The names of the respondents will not be used in this study and will be kept confidential to protect their identity and ensure their confidentiality.

### **Sampling**

The non-probability sampling strategy used in this study is based on belief sampling. The sample is chosen from the population at random by the researchers, who only consider areas that are easily accessible to them. The researchers didn't consider selecting a sample that is typical of the whole population because these samples are simple to recruit, so they chose this sampling strategy instead. This sample is chosen because it is affordable and makes the sample more readily available.

This method is utilized to sample the target population for this study, which is the people in Rantau Panjang, Kelantan, which focuses on the public stakeholders for the growth of crossborder tourism. The survey was created with Google Forms and disseminated via internet channels like social media apps like WhatsApp and others. The researcher was able to contact respondents from Kelantan State who are challenging to meet in person by using Google Forms and social media.

### **Data Analysis**

This study uses four data analysis types which is descriptive statistics, reliability statistics, and Pearson's correlation. The data obtained were analysed by using SPSS version 29. The use of SPSS in the study helps to achieve the research objectives and helps to process the data that has been obtained.

## FINDINGS Demographic Analysis

The data analysis for this inquiry included frequency analysis. The respondents' numerous demographic data, such as gender, race, age, marital status, level of education, and state of residence, were questioned in Section A of the questionnaire. A table displaying the respondents' demographic profiles was visible.

**Table 1: Demographic Analysis**

Item	Frequency (n)	Percentage (%)
Gender		
<i>Male</i>	204	54.0
<i>Female</i>	174	46.0
Age Group		
<i>Below 20 years old</i>	41	10.8
<i>21-30 years old</i>	254	67.2
<i>31-40 years old</i>	69	18.3
<i>41 and above</i>	14	3.7
Race		

<i>Chinese</i>	94	24.9
<i>Indian</i>	104	27.5
<i>Malay</i>	157	41.5
<i>Others</i>	23	6.1
Status		
<i>Married</i>	76	20.1
<i>Single</i>	302	79.9
Region		
<i>Islam</i>	163	43.1
<i>Christian</i>	83	22.0
<i>Hindu</i>	87	23.0
<i>Buddha</i>	45	11.9



State		
<i>Johor</i>	36	9.5
<i>Selangor</i>	25	6.6

<i>Sarawak</i>	28	7.4
<i>Sabah</i>	8	2.1
<i>Terengganu</i>	11	2.9
<i>Kedah</i>	26	6.9
<i>Kelantan</i>	86	22.8
<i>Melaka</i>	38	10.1
<i>Negeri Sembilan</i>	39	10.3
<i>Pahang</i>	23	6.1
<i>Perak</i>	20	5.3
<i>Perlis</i>	12	3.2
<i>Pulau Pinang</i>	26	6.9

Education Background		
<i>SPM</i>	40	10.6
<i>Diploma</i>	91	24.1
<i>Degree</i>	231	61.1
<i>Master</i>	14	3.7
<i>Others</i>	2	.5

Occupation		
<i>Student</i>	263	69.6
<i>Employed</i>	97	25.7
<i>Unemployed</i>	18	4.8
Frequency of Visit		
<i>Sometimes</i>	294	77.8
<i>Every weekend</i>	58	15.3

<i>Everyday</i>	12	3.2
<i>Others</i>	14	3.7
Have you ever visit		
<i>Yes</i>	351	92.9
<i>No</i>	27	7.1
With whom do you go		
<i>Family</i>	97	25.7
<i>Friends</i>	182	48.1
<i>Spouse</i>	43	11.4
<i>Alone</i>	56	14.8
When was the last time you visited Rantau Panjang		
<i>Last year</i>	151	39.9
<i>Last month</i>	133	35.2

<i>Last week</i>	69	18.3
<i>Yesterday</i>	20	5.3
TOTAL	378	100.0

The gender of the respondents was shown in Table 4.2. Male respondents made up 204 of the total respondents, while female respondents made up 174. A total of 378 respondents participated in this survey, with 54.0% of them being men and the remaining 46.0% being women. Among the 378 respondents, 41 were under the age of 20, 254 were between the ages of 21 and 30, 69 were between the ages of 31 and 40, and 14 were over the age of 41. According to Table 4.3, respondents with an age range between 21 and 30 years made up the majority of respondents (67.2%), followed by respondents with an age range between 31 and 40 years (18.3%), and respondents with an age range between 41 and above made up the least number of respondents (3.7%). The overall number of respondents 302 for those who were single, 76 for those who were married, and 378 for all respondents was 378. Out of 378 respondents, 79.9% were single overall, while 20.1% were married participants in the survey. Malay respondents made up 157 of the 378 respondents, followed by Chinese respondents with 94, Indian respondents with 104, and others with 23. According to Table 4.6, Malay respondents made up the highest proportion of respondents (41.5%), followed by Indian respondents (27.5%), Chinese respondents (24.9%), and other respondents (6.1%), who made up the lowest proportion. The total number of respondents who identified as Muslim (163), Christians (83), Hindus (87), and Buddhists (45). Islam had the biggest percentage of respondents (43.1%), followed by Hinduism (23.0%), Christianity (22.0%), and Buddhism (11.9%), which had the lowest percentage. With 86 responses, Kelantan had the highest percentage of respondents (22.8%), followed by Negeri Sembilan with 39 respondents and 10.3%. The least were 2.1% (8 respondents) who were from primary, followed by 10.1% (38 respondents) from secondary and 9.5% (36 respondents) from Johor. Degree holders made up the majority of the respondents with a ratio of 61.1% (231 respondents), followed by Diploma holders with 61.1% (91 respondents). There were 10.6% (40 respondents) with an SPM degree, 3.7% (14 respondents) with a master's degree, and 0.5% (2 respondents) with a different level of education. There were a total of 263 respondents who identified as students, 97 who identified as employed, and 18 who identified as jobless. Out of a total of 378 respondents, 69.6% were students, 25.7% were working adults, and the remaining 4.8% were jobless adults that participated in the survey. Weekend trips to Rantau Panjang were occasionally reported by 294 respondents (77.8%) and 58 respondents (15.3%) respectively. The least number of respondents, 12 respondents with (3.2%), went to Rantau Panjang every day, while 14 respondents with 3.7% were reported as others. There were 351 responses in total who had visited, whereas 27 respondents had never done so. In a survey of 378 people, 92.9% said had travelled, and 7.1% said they had never been anywhere.

In total, 182 respondents answered the question about their friends, 97 answered it about their family, 43 answered it about their spouse, and 56 answered it about themselves. 48.1% of the 378 respondents were friends, 25.7% were relatives, 11.4% were married, and the remaining 14.8% were alone. By the end of last year, 151 respondents had visited Rantau Panjang, 133 had done so in the previous month, 69 had done so in the previous week, and 20 had done so yesterday. According to Table 4.14, the biggest percentage of replies came from the previous year (39.9%), followed by the previous month (35.2%), the previous week (18.3%), and yesterday (5.3%).

**RESULT OF DESCRIPTIVE ANALYSIS Independent Variable and Dependent Variable**  
**Table 2: Descriptive Analysis**

<b>Variable</b>	<b>Items</b>	<b>Mean Score</b>	<b>Standard Deviation</b>
<b>Tourist Perception</b>	1. The level of community cleanliness in Rantau Panjang is very high	3.77	.994
	2. The quality of public services in Rantau Panjang is very good	3.86	.978
	3. Traffic flow in Rantau Panjang is very controlled	3.86	.970
	4. The availability of clean drinking water is very sufficient in Rantau Panjang	3.81	.995
	5. Rantau Panjang is free from drugrelated activities	3.88	.952
	6. Rantau Panjang is free from any threat of terrorism	3.87	.988
	7. Cultural activities are very popular in Rantau Panjang	3.90	.957
<b>Infrastructure Issues</b>	1. I feel that cross-border tourism attracts more tourist	3.93	.977
	2. Cross-border tourism creates a good impact on the tourism industry	4.01	.940
	3. Rantau Panjang has a variety of accommodation options	3.87	.957
	4. The state of infrastructure in Rantau Panjang is very satisfactory	3.86	.981

	5. There are various shop facilities in Rantau Panjang	3.89	.972
	6. A wide selection of restaurants available in Rantau Panjang	3.95	.970
	7. Tourism services in Rantau Panjang are of very high quality	3.99	.964
<b>Destination Image</b>	1. Natural attractions in Rantau Panjang are not affected by the development of cross-border tourism	3.85	.983
			.990
	2. The travel environment in Rantau Panjang is safe and secure	3.84	
	3. Spectacular scenery and natural uniqueness are tourist attractions in Rantau Panjang	3.80	1.000
	4. Rantau Panjang has its own history and heritage	3.92	.941
	5. Rantau Panjang has beautiful lakes and rivers	3.89	.977
	6. A calm and peaceful atmosphere in Rantau Panjang	3.85	1.031
	7. Easy to access Rantau Panjang area	3.86	.978
<b>Tourist Satisfaction</b>	1. I felt joy and satisfaction after visiting Rantau Panjang	3.93	.968
	2. The travel experience to the Rantau Panjang has fulfilled my expectation.	3.93	.975

3. I think that visiting Rantau Panjang was the wise choice.	3.97	.932
4. The trip to the Rantau Panjang was well worth my time and money.	4.00	.910
5. I have gained knowledge about city urban design after visiting Rantau Panjang	3.98	.954
6. I am satisfied with the price of goods sold in Rantau Panjang	3.98	.952

The mean and standard deviation analysis for the independent variable, tourists' perception, was displayed in Table 2. The respondents who agreed that the cultural events are very popular in Rantau Panjang gave item number 7, with a mean score of 3.90, the highest mean score. The responder only slightly agreed that the level of community cleanliness in Rantau Panjang, which had the lowest mean value of item number 1 at 3.77. The values near to the mean were highlighted for the data set from 378 respondents with a standard deviation most frequently lower than 1. The study of the mean and standard deviation for the independent variable, which was the state of the infrastructure, was shown in Table 2. Item number 2, where respondents agreed that cross-border travel had a positive impact on the tourism business, had the highest mean value, 4.01. The responder just slightly agreed that the infrastructure of Rantau Panjang is in very good shape, which resulted in the lowest mean value for item number 4, which was 3.86. With a standard deviation that was mostly more than 1, the data set from 378 respondents revealed values that were near to the mean. The independent variable, the destination picture, was the subject of a study of mean and standard deviation in Table 2. The respondents' agreement that Rantau Panjang has its unique history and traditions led to item number 4, which had the highest mean value at 3.92. The respondent very slightly agreed that Rantau Panjang's stunning beauty and natural uniqueness are among the city's tourism attractions, giving the item with the lowest mean value—3.80—that description. With a standard deviation that was mostly more than 1, the data set from 378 respondents revealed values that were near to the mean. The tourist satisfaction of the growth of cross-border tourism in Rantau Panjang was the dependent variable, and Table 2 displayed the mean and standard deviation analysis on it. The respondents who responded to item number 4 agreed that the journey to the Rantau Panjang was well worth my time and money, giving that item the highest mean score of 4.00. The response marginally agreed that I felt delight and satisfaction after visiting Rantau Panjang and that the travel experience to the Rantau Panjang matched my expectations. The lowest mean value was item numbers 1 and 2, which was 3.93 for the two items. The majority of the answers for the data set from 378 respondents with a standard deviation lower than 1 suggested value near to the meanwhile the standard deviation.

## RELIABILITY TEST

The dependability of the surveys was evaluated using reliability analysis. According to Hair et al. (2007), the information's external and internal consistency was ensured using Cronbach's Alpha analysis. The Rules of Thumb in the table below were used to determine the size of the Cronbach's Alpha coefficient.

Table 3 Rules of Reliability Coefficient Alpha for the Independent Variable and Dependent Variable

Variable	Number of Items	Cronbach's Coefficient Alpha	Strength of Association
Tourist Perception	7	0.924	Excellent
Infrastructure Issues	7	0.938	Excellent
Destination Image	7	0.944	Excellent
Tourist Satisfaction	6	0.935	Excellent
Overall Variables	27	0.713	Acceptable

The aggregate Cronbach's Alpha Coefficient for the independent variable and dependent variable in this study was displayed in Table 4.20. We may infer from the table that all of the variables were above the value of 0.6 and that the total number of variables was 0.818. As a result, the outcome was trustworthy and appropriate for this study.

### **Pearson Correlation Analysis**

#### **Pearson Correlation Coefficient**

The linear correlation between two random variables is determined using the Pearson's correlation coefficient vectors, which have real values. In this study, the dependent variable (tourist satisfaction with cross-border tourism development in Rantau Panjang) and the independent factors (tourist perception, infrastructural issues, and destination image) were examined to see whether any links existed. If there is a significant relationship, the researcher must decide if the association's strength was conventional.

Table 4: Pearson Correlation Analysis



Hypothesis	Result	Finding of Data Analysis
<b>H1:</b> There is a significant relationship between tourist perception and tourist satisfaction of cross-border tourism development in Rantau Panjang.	r = 0.851, p = 0.000 High positive	<b>H1: supported</b>
<b>H2:</b> There is a significant relationship between infrastructure issues and tourist satisfaction of cross-border tourism development in Rantau Panjang.	r = 0.867, p = 0.000 High positive	<b>H2: supported</b>
<b>H3:</b> There is a significant relationship between destination image and tourist satisfaction of cross-border tourism development in Rantau Panjang.	r = 0.831, p = 0.000 High positive	<b>H3: supported</b>

The total number of cases used in the study (378) and the Pearson correlation coefficient are shown in Table 4.23. The needed significance level of 0.01 was not met by the p-value of 0.000. The expansion of cross-border travel in Rantau Panjang was positively correlated with tourists' perceptions of it and their contentment, according to the 0.851 correlation coefficient. Pearson correlation coefficient, significant significance, and overall number of cases (378) used in the study. The p-value was 0.000, falling short of the required significance level of 0.01. The p-value was 0.000, falling short of the required significance level of 0.01. The significant positive association between infrastructure issues and visitor satisfaction with the expansion of cross-border tourism in Rantau Panjang was shown by the correlation coefficient of 0.867. The number of cases used in the study (378), the significant significance, and the Pearson correlation coefficient were all displayed in Table 4.25. The p-value was 0.000, falling short of the required significance level of 0.01. The p-value was 0.000, falling short of the required significance level of 0.01. The development of cross-border tourism in Rantau Panjang was strongly positively correlated with tourist satisfaction, as indicated by the correlation coefficient of 0.831.

## DISCUSSION AND RECOMMENDATION

We all know that Rantau Panjang is a city on the Malaysia–Thailand border situated in the north of the state of Kelantan in the western region of the Pasir Mas colony based on chapters 1–4 of this study. It is situated next to the Golok River in Narathiwat, Thailand, 39 kilometres southwest of Kota Bharu. Rantau Panjang is

well known for its numerous retail goods and mementos. To stop the smuggling of goods including drugs, rice, sugar, and people, among other things, the Anti-Smuggling Unit, the Royal Customs and Excise Department, the Immigration Department, and the Royal Malaysian Police conduct inspections. Duty-free shopping is a well-known feature of Rantau Panjang. The suggestions in this chapter will be based on the Garis Panduan Perancangan Kawasan Perdagangan and will deal with improving the facilities so that they are more adequately supplied with essentials. Since Majlis Daerah Pasir Mas has authority over the Rantau Panjang market, Daerah Pasir Mas also has a big influence on the development of the market's facilities. Additionally, the facilities ought to make it convenient for market patrons and guests to visit Rantau Panjang.

#### Traffic Management

- i. Rantau Panjang market should provide pedestrian space.

Pedestrian walkways are one of the conveniences for locals and tourists to use the road. There are also pedestrian walkways accessible to prevent people from using the road as their route to go to each location. A pedestrian route is one of the essential features that must be offered in the market area. The Garis Panduan Perancangan Kawasan Perdagangan states that these pedestrians must to be present in the market area to permit easy access for locals and visitors to different locations. It also serves as a means of preventing accidents.

- ii. Upgrade the Lot Line of Car Parking

The parking lot line appears faded and some of it is congested. Utilising road signs or a parking queue will help the already-existing parking places. Visitors can park their cars more efficiently and avoid double parking thanks to this road marker. Everyone should pay attention to the lot line since it marks the boundary between parking and the necessity to prevent parking overlap.

iii. Supporting facilities

The surau needs to be renovated because of the building's deteriorating condition and faded colour. The surau needs to be updated because it can draw in the public's interest while also providing users with comfort.

## CONCLUSION

Tourist satisfaction has a substantial impact on overall contentment when cross-border tourism development, with tourist perception, infrastructure issues, and destination image all playing an important factor. According to the data, practically all respondents completed the survey questions on their satisfaction with cross-border tourism development in Rantau Panjang, Kelantan. The majority of respondents firmly agreed that tourist satisfaction has a significant impact on their satisfaction while visiting cross-border tourism development. Respondents also agreed that tourist perception, infrastructure issues, and destination image play an important role when visiting Rantau Panjang, Kelantan.

## REFERENCES

- Akter, M., Sadekin, M. N., & Patwary, A. K. (2020). An Empirical Study on Students' Satisfaction from Mawlana Bhashani Science & Technology University, Bangladesh. *Review of Economics and Development Studies*, 6(2), 363-379.
- Alexandr N. Dunets, V. N. (2019). CROSS-BORDER TOURISM COOPERATION AS A BASIS FOR SUSTAINABLE DEVELOPMENT: A CASE STUDY. *ENTREPRENEURSHIP AND*

- Alom, S., Patwary, A. K., & Khan, M. M. H. (2019). Factors affecting the turnover intention of Bangladeshi migrants in the United Arab Emirates: An empirical study on the hotel industry. *International Journal of Innovation, Creativity and Change*, 8(3), 344-360.
- Anuar, A. R., & Harun, A. (2018). Malaysia-Thailand Cross Border Trade and Cross Border Special.
- Azinuddin, M., & Mior Shariffuddin, N. (2022). A Systematic Literature Review on Tourism Networks, Evaluating “Good” Governance in Cross-Border Regions. *Journal of Borderlands Studie*, 37 (5), 1047-1070. Retrieved from *Journal of Borderlands Studie*
- Fengmin, Z., Baijun, W., Jiangtao, B., Li, L., & Patwary, A. K. (2022). Investigating revisit intention of medical tourists in China through nutritional knowledge, perceived medical quality, and trust in the physiologist: A recommendation on health tourism policy measures. *Frontiers in Public Health*, 10, 893497.
- Findell, E. (2021). In a Texas Border Town, Armed Groups Arrive to Look for Migrants. *The Wall Street Journal*, 1-18. Retrieved from <https://www.wsj.com/articles/in-a-texas-border-town-armedgroups-arrive-to-look-for-migrants-11639668989>
- Hazbar, A. M. H., Alem Mohammed, A., & Karim, A. K. A. (2019). An Empirical Study of Factors Influencing hotel customers' online booking Intention. *مجلة العلوم التربوية و الدراسات الإنسانية*, (5), 1-17.
- Hong Ching, G., Wan Hin, T., & Fei Ern, C. (2014). Border town issues in tourism development: The case of Perlis,. *Malaysian Journal of Society and Space*, 10 (2), 68-79. Retrieved from [http://journalarticle.ukm.my/7121/1/6.geografia-april\\_2014-Goh\\_Hong1-edam.pdf](http://journalarticle.ukm.my/7121/1/6.geografia-april_2014-Goh_Hong1-edam.pdf)
- Hussin, F., Abdullah, N., Maamor, S., & Abdullah, H. (2012). Border Economy: Issues and Problems Faced by. *Journal of Sociological Research*, 46-56.
- Kidokoro, T. (2022). Cross-Border Integration, Cooperation and Governance: A Systems Approach for Knowledge. *Journal of Taylors*, 11 (1), 179–218. Retrieved from <https://fslmjournals.taylors.edu.my/>
- Kozak, M. (2019). Cross–border destination marketing and peacemaking:Prerequisites and critical success factors. *Journal of Destination Marketing & Managment*, 14, 1-9. Retrieved from <https://doi.org/10.1016/j.jdmm.2019.100392>
- Lenglet, F. (2018). Destination distinctiveness: Concept, measurement, and impact on tourist. *Journal of Destination Marketing & Management*, 214-231. Retrieved from [www.elsevier.com/locate/jdmm](http://www.elsevier.com/locate/jdmm)
- Li, L., Ragavan, N. A., Patwary, A. K., & Baijun, W. (2022). Measuring patients' satisfaction toward health tourism in Malaysia through hospital environment, nutritional advice, and perceived value: A study on Chinese exchange students. *Frontiers in public health*, 10, 893439.
- Li, L., Wu, B., & Patwary, A. K. (2022). How marine tourism promote financial development in sustainable economy: new evidences from South Asia and implications to future tourism students. *Environmental Science and Pollution Research*, 29, 1155-1172.
- Li, L., Wu, B., & Patwary, A. K. (2022). The psychosocial factors affecting chinese Outbound Exchange and mobility students’ academic performance during COVID-19. *Frontiers in psychology*, 13, 872516.
- Merz, B., & Kreibich, H. (2010). Assessment of economic flood damage. *Natural Hazards*, 10 (8), 16971724. Retrieved from <https://doi.org/10.5194/nhess-10-1697-2010>

- Mutanga, C. N., & Vengesayi, S. (2017). Travel motivation and tourist satisfaction with wildlife tourism experiences. *Journal of Outdoor Recreation and Tourism*, 1-18. Retrieved from [www.elsevier.com/locate/jort](http://www.elsevier.com/locate/jort)
- Patwary, A. K., Roy, B., Hoque, R., & Khandakar, M. S. A. (2019). Process of developing a community based tourism and identifying its economic and social impacts: An Empirical study on Cox's Bazar, Bangladesh. *Pakistan Journal of Humanities and Social Sciences*, 7(1), 1-13.
- Rosselló, J., Becken, S., & Santana-Gallego, M. (2020). The effects of natural disasters on international tourism: A global analysis. *Tourism Management*, 79, 1-10. Retrieved from <http://www.elsevier.com/locate/tourman>
- Sumethokula, P., Patwary, A. K., Srinuanpanc, B., Srinuanpand, C., Suwandee, P., Thammathikul, A., & Phanong, W. (2020). The potential of new tour repackaging for creative tourism among entrepreneurs in Nakhon Si Thammarat. *International Journal of Innovation, Creativity and Change*, 13(10), 1752-1771.
- Wu, B., Liu, S., Wang, J., Tahir, S., & Patwary, A. K. (2021). Assessing the mechanism of energy efficiency and energy poverty alleviation based on environmental regulation policy measures. *Environmental Science and Pollution Research*, 28, 40858-40870.
- Wu, B., Zhai, B., Mu, H., Peng, X., Wang, C., & Patwary, A. K. (2021). Evaluating an economic application of renewable generated hydrogen: A way forward for green economic performance and policy measures. *Environmental Science and Pollution Research*, 1-15.

# Factors Influencing Destination Loyalty Among Domestic Tourist In Perhentian Island, Terengganu, Malaysia

Umi Hafiza Binti Othman, Wan Nor Eli Hanis Binti Wan Zahari, Wan Nor Maizatul Iwani Binti Wan Abdul Razak, Wan Nur Farah Hanim Binti Wan Roslan

\* Puan Siti Selimah Binti Che Hasan

*Faculty of Hospitality, Tourism and Wellness, Universiti Malaysia Kelantan*

*Corresponding email: [h20a1853@siswa.umk.edu.my](mailto:h20a1853@siswa.umk.edu.my)*

---

## ABSTRACT

*Perhentian Island is a famous seaside resort in Malaysia that is the focus of tourists. This study aims to look at Factors Influencing Destination Loyalty Among Domestic Tourists in Perhentian Island, Terengganu, Malaysia. This study focuses on elements such as destination loyalty among domestic tourists such as destination attractiveness, place attachment, tourist satisfaction, and service quality that affect domestic tourists' commitment to their chosen destination. A quantitative research method was chosen, the information was gathered utilizing a survey with 384 respondents. Three types of analysis were used in the data namely, descriptive, reliability, and Pearson Correlation Analysis. As a result, all the independent variables (destination attractiveness, place attachment, tourist satisfaction, and service quality) that have been studied in this research have a significant relationship with the dependent variable (destination loyalty) among domestic tourists who visit Perhentian Island, Terengganu, Malaysia. Hopefully, the facts presented throughout this research can help related parties in generating money and profits, thereby improving the Malaysian economy.*

**Keywords:** Destination Loyalty, Destination Attractiveness, Service Quality, Tourist Satisfaction, Place Attachment, Domestic Tourist.

---

## INTRODUCTION

This study examines the satisfaction and loyalty of holidaymakers towards tourist destinations in Asian nations by taking Perhentian Island as the study destination. By recognising that visitor satisfaction will provide an assessment of the quality of the service and other elements that are sought to draw visitors in the future, this study is essentially finished. With the rise of the level of satisfaction, it's expected that the amount can increase holidaymaker loyalty because high satisfaction can encourage tourists to form repeat visits additionally to encouraging different tourists to visit.

Next, the results of this study may help to design marketing and customer loyalty plans for the destination by determining the precise variables that affect destination loyalty among domestic travellers in Perhentian Island. Finding any special or unusual elements that affect domestic visitors' destination loyalty on Perhentian Island could help to set the place apart from rival tourist spots. Providing insight into the characteristics and behaviors of loyal tourists in Perhentian Island, which could help to target marketing efforts and improve the overall visitor experience.

This study is important to a few sides that are involved in tourism. From the perspective of the satisfaction tourists of visiting Perhentian Island can increase the arrival of tourism to the island. The management can use the available capital to improve the Perhentian Island facilities. Tourists can also enjoy the island and learn about cultures

based on the findings of our study. Plus, the tourists who want to visit Perhentian Island will be benefited by this study.

Hence, the focus of this study was on the variables affecting Perhentian Island domestic travellers' destination loyalty. First and foremost, this chapter will explain specifically the background of the study, particularly related to the history of Perhentian Island. Next, the problem statements are also discussed in this chapter, which focuses on the issues or difficulties that exist on Perhentian Island and contribute to a downturn in local visitor arrivals. Research questions are specific questions that the research is meant to address, whereas the study's objectives represent the goals of the study. It serves as the basis for systematic research and helps to define the research process precisely. On the other side, the importance of the study describes the significance of doing the research. Additionally, every term used in the study is defined in the terms of reference section. Lastly, a summary of the whole chapter is also discussed in the last part of the chapter.

There are four objectives of this research:

1. To identify the relationship between destination loyalty and destination attractiveness.
2. To study the relationship between place attachments and destination loyalty.
3. To investigate the relationship between the tourist satisfaction and destination loyalty.
4. To investigate the relationship between service quality in waste management and destination loyalty.

### Significance of The Study

By examining the attractiveness of the destination, place attachment, tourist satisfaction, and service quality, this study will enable us to better understand how to evaluate destination loyalty among local travellers to Perhentian Island, Terengganu. In Perhentian Island, Terengganu, Malaysia, we are conducting this study to determine whether elements such destination allure, place attachment, tourist satisfaction, and service quality have an impact on domestic travellers' destination loyalty. Future scholars who focus on the same subject may find this study useful in understanding tourists' intentions to return to Malaysian tourist destinations. Additionally, it will be useful for others to understand the variables that affect Malaysian domestic tourists' destination loyalty. On top of that, this study can provide new findings to other researchers and tourism industry pioneers to better improvise their business in order to get revisited from the tourists.

## LITERATURE REVIEW

### Destination Loyalty

Magatef & Tomalieh (2015) explained that less money is spent on destination promotion expenditures, and giving service to loyal customers is less expensive than to new ones. Destination loyalty, according to Wang et al. (2009), is the propensity of travellers to promote a place to others. This explanation speaks to the attitude component of customer loyalty. On the other hand, Chen and Tsai (2007) defined destination loyalty as the choice made by visitors of going back to the exact same place and the inclination to recommend it to others.

### Destination Attractiveness

According to Xu and Zhang (2016), destination attractiveness and destination image have both been measured and utilised interchangeably. These characteristics include man-made features like theme parks and infrastructure as well as cultural and natural features like beaches, hills, and caves. These attractions play a significant role in luring travellers to a specific location. Additionally, Nasir

et al. (2020) suggest that destination appeal refers to a visitor's emotions, ideas, and opinions about the natural attractiveness, cultural attractiveness, and infrastructure inside the area satisfying specific.

### Place Attachment

Place attachment, as defined by Nasir et al. (2020), is a powerful emotional bond that develops between a tourist and a certain location when the traveller values and exhibits sincere interest in the location's experiences. The outcome of subsequent assessment at a specific location is place attachment. Place attachment can be measured in two, three, or four dimensions. Hosany et al. (2017) employed two dimensions to quantify place attachment: place reliance, which assesses how well a setting supports a person's aims and aspirations, and place identification, which evaluates how strongly a person's identity is related to a specific natural location.

### Tourist Satisfaction

Satisfaction among customers is able to be described as either a process that accentuates the end-state derived from the consumer experience or an outcome that underlines the perceptual, evaluative, and psychological processes that lead to customer happiness (Varvara, 1997). According to this definition, customer satisfaction is measured while services are rendered. The consumer will feel disappointed or unsatisfied if the perceived performance is below the planned performance (Kotler, 2008). According to Choi and Chu (2001), a consumer is said to be satisfied when an event matches their weighted average of hopes making them pleased.

### Service Quality

The issue has generated a lot of interest and discussion in the academic literature because it is challenging to define and evaluate the quality of services since there is no agreement in either area (Wisniewski et al., 1996). Customers are dissatisfied when expectations exceed performance (Parasuraman et al., 1985). A research gap is essentially an unresolved problem or unexplored subject in an area as a result of insufficient earlier investigation. When there has been a significant quantity of prior study but the findings go in different ways, making it difficult to make firm conclusions, there may still be a research gap.

### Research Hypothesis

A hypothesis needs to be testable and acceptable, taking into account the most recent findings and research methods. A hypothesis is also an assumption or an explanation of the relationship between two variables. It shows that an independent variable and a dependent variable are causally related. As a result, the study suggests:

H1: There is a considerable connection between the attractiveness of a destination and loyalty to that destination.

H2: Place attachments and destination loyalty have a significant relationship.

H3: Tourist satisfaction and destination loyalty are significantly correlated.

H4: Service quality and destination loyalty are significantly correlated.

## Research Framework

Figure 1 depicts the conceptual foundation for this study. The independent variable that will be suggested is made up of four variables: tourist satisfaction, place attachment, destination attractiveness, and service quality. The dependent variable is loyalty to a destination. As a result, this paradigm will illustrate how independent and dependent variables relate to one another.

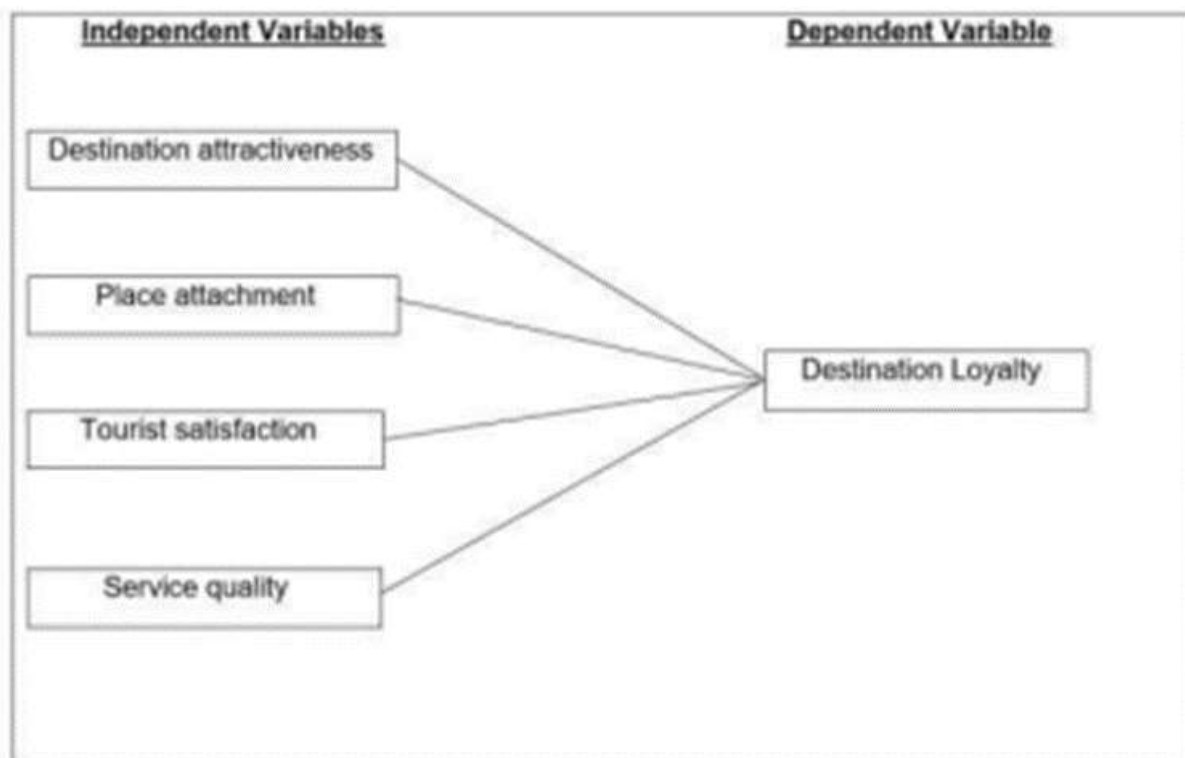

Figure 1: Independent variables and dependent variables in the conceptual framework

Source: (Mohamad et. al., 2019)

## METHODOLOGY

### Research Design

The study's design represents the factors that impact destination loyalty among domestic tourists in Perhentian Island. A quantitative technique will be used in this study, and data will be collected from individuals using a self-directed questionnaire. Because this study's objectives are to prove a causal relationship between variables, a causal research design was used. As a result, this study used a cross-sectional design. The acquisition of information at one period, and in relation to correlations between variables at a single period of time are two benefits of a cross-sectional design.

### Data Collection

Online surveys made with Google Forms were used in the initial phase of data collection for this project. This platform of technical tools was used by the researcher because it was free and simple to use. Additionally, it makes it simple for the researcher to collect all the data from local tourists. Fieldwork was the second phase of data collecting. Actually, the main tool for acquiring data for this



study was a questionnaire. Respondents must complete all six of the sections of the questionnaire. To gather information on Malaysian tourists, a questionnaire was made available to the general public.

### Sampling

Convenience sampling, a non-probability sample method, is employed in this study. The term "convenience sampling" refers to a technique used by researchers to gather data from a sample of easily available respondents for market studies. The most popular sample procedure is made possible by the fact that it is so quick, easy, and inexpensive. It is generally easy to persuade participants to participate in the sample. Additionally, the study's methodology used a quantitative approach.

### Data Analysis

Five different data analysis methods, including SPSS, frequency analysis, descriptive statistics, reliability, and Pearson Correlation Coefficient Analysis, are employed by the researchers. In order to review and analyse the primary data that was collected from the respondents, we use Statistical Package for the Social Sciences (SPSS) version 25 software. SPSS is a statistical analysis programme that aids researchers in analysing their study objectives and processing the collected data.

## FINDINGS

### Result of Reliability Analysis

Table 1: Result of Reliability Test

Name of Variables	Cronbach's Alpha	Value N of Items	Remarks (acceptable/not acceptable)
Destination Attractiveness	0.862	8	Acceptable
Place Attachment	0.849	5	Acceptable
Tourist Satisfaction	0.878	3	Acceptable
Service Quality	0.932	8	Acceptable
Destination Loyalty	0.915	4	Acceptable

The result of reliability analysis for the independent and dependent variables of the study were shown in Table 1. Independent variables include destination attractiveness, place attachment, tourist satisfaction, and service quality while dependent variable is destination loyalty. Cronbach's Alpha value of destination attractiveness is 0.862, place attachment is 0.849, tourist satisfaction is 0.878, and service quality is 0.932. Additionally, destination loyalty resulted 0.915 of Cronbach's Alpha value. All of the independent variables results were acceptable because it is over than 0.70. Furthermore, dependent variable which is destination loyalty also acceptable because the score result is 0.915 and it's over than 0.70 value, demonstrating that the variables used were suitable and accurate for

assessing this variable. In conclusion, according to Cronbach's alpha, the reliability coefficients for the independent variables in this study were satisfactory and associated with one another.

#### Result of Frequency Analysis (Respondents' Demographic Information)

384 respondents completed the survey, which included filter questions, and the results of the demographic profile of the respondents were gathered and summarized. Gender, age, race, status, occupation, income, and place of origin are demographic questions that have been asked in the questionnaires.

Table 2: Result of Frequency Analysis (Demographic Analysis)

Items	Frequency (N)	Percentage (%)
Gender		
Male	103	26.8
Female	281	73.2
Age		
18 – 20 years old	13	3.4
21 – 25 years old	358	93.2
26 – 30 years old	9	2.3
31 – 35 years old	2	0.5
> 36 years old	2	0.5
Race		
Malay	362	94.3
Chinese	10	2.6
Indian	7	1.8
Other	5	1.3
Status		
Student	335	87.2
Work	47	12.2
Other	2	0.5
Occupation		
Student	332	86.5

Government Servant	10	2.6
Private Worker	23	6.0
Self-Employment	9	2.3
Others	10	2.6
Income		
< RM1,500	67	17.4
RM1,501 – RM3,000	31	8.1
RM3,001 – RM4,500	8	2.1
RM4,501 – RM6,000	2	0.5
>RM6,000	1	0.3
No Income	275	71.6
Place of Origin		
Kedah	56	14.6
Perlis	4	1.0
Pulau Pinang	16	4.2
Perak	8	2.1
Kelantan	73	19.0
Terengganu	113	29.4
Pahang	45	11.7
Selangor	17	4.4
Wilayah Persekutuan Kuala Lumpur	5	1.3
Johor	26	6.8
Melaka	5	1.3
Negeri Sembilan	3	0.8
Sarawak	6	1.6
Sabah	7	1.8
Total	384	100.0

According to Table 2 above, the total number of 384 respondents are 100% Malaysian domestic tourists that are visiting Perhentian Island, Terengganu, Malaysia. Firstly, the majority of the respondents are female 73.2% than males 26.8%. This is because most of the female respondents who answered the questionnaire stated that they are traveling more to Perhentian Island, Terengganu.

Next, the highest age group of respondents is from 21 – 25 years old with 93.2%. This is due to the intention to travel and the time freedom that they have to spend with their family and friends. Besides, 94.3% are Malays that answered the questionnaire and it is because most of the population in Perhentian Island, Terengganu are Malays. 87.2% of respondents hold status as students where they prefer to travel to Perhentian Island, Terengganu when holidays or semester break. On top of that, the highest percentage of occupation is 86.5% of students who travel in order to release their stress on studies. Next, the highest percentage of income is 71.6% that is from no income group since students are the majority community to travel to Perhentian Island. Their willingness to travel with their fellow friends makes it happen even though they don't have enough sources of income. Last but not least, is a place of origin. Respondents who come from Terengganu stated 29.4% more than other states in Malaysia. This is because, the population of the study is basically from Terengganu, Malaysia and that is why Terengganu holds the highest percentage among others.

### Result of Descriptive Statistics

The researchers examined the mean and standard deviation for each variable in the study of 384 respondents who visited Perhentian Island, Terengganu.

Table 3: Descriptive Statistics of Dependent Variable and Independent Variable

Variables	Items	N	Mean Score	Standard Deviation
Destination Attractiveness	1. Easy to access transportation services.	384	3.78	0.870
	2. Good service and comfortable accommodation.	384	4.18	0.674
	3. Shopping and entertainment facility.	384	3.77	0.891
	4. Good quality and tasty food and beverages.	384	4.02	0.793
	5. Multiple historical attractions and places.	384	3.73	0.891
	6. Multiple cultural events and attractions.	384	3.93	0.817
	7. Rich in natural scenery and calmness of the places.	384	4.43	0.701
	8. Pleasant climate and full of a positive vibe environment.	384	4.25	0.723
Place Attachment	1. I like visiting Perhentian Island more than any other destination.	384	3.74	0.895
	2. For me, Perhentian Island is an excellent choice for an enjoyable vacation destination.	384	4.08	0.779
	3. I have really special memories of Perhentian Island.	384	3.81	1.01
	4. Get good feedback from outsiders about Perhentian Island.	384	4.07	0.770
	5. Have strong self-attractiveness at Perhentian Island.	384	4.30	0.713

Tourist Satisfaction	1. My overall evaluation of a vacation in Perhentian Island is well worth the money, time, and energy invested.	384	4.13	0.785
	2. Vacation satisfaction is satisfying and provides a sweet moment.	384	4.20	0.721
	3. I am satisfied with my vacation in Perhentian Island.	384	4.12	0.772
Service Quality	1. Cleanliness and easy-to-find food and beverage facilities.	384	3.99	0.768
	2. Take great care of cleanliness in public toilets.	384	3.85	0.830
	3. Customer-friendly attitude shown by the seller towards the customer.	384	3.97	0.801
	4. The seller's honesty with customers.	384	3.80	0.894
	5. Signs and information symbols that are clear and easy to understand.	384	4.03	0.726
	6. Comfortable and reasonable prices of rental vehicles.	384	3.89	0.822
	7. Cleanliness of the hotel is taken care of thoroughly.	384	4.03	0.733
	8. Maintain their food and beverage standards at the hotel.	384	3.96	0.750
Destination Loyalty	1. I will revisit Perhentian Island.	384	4.12	0.789
	2. I will probably revisit Perhentian Island in the future.	384	4.23	0.764
	3. I will recommend Perhentian Island to others.	384	4.27	0.697
	4. Perhentian Island vacation lived up to my expectations.	384	4.08	0.780

Destination attractiveness, item seven scored the highest mean value which is 4.43, where the respondents strongly agree that Perhentian Island is rich in natural scenery and calmness and it influences their loyalty to revisit that place. Item five is the lowest mean score with 3.73 where respondents agreed that multiple historical attractions and places inspired them to revisit Perhentian Island. Place attachment, item five scored the highest mean value with 4.30 where respondents strongly agree that Perhentian Island has strong self-attractiveness. In contrast, item one scored the lowest mean with 3.74 where respondents stated that they tend to visit Perhentian Island more than any other destinations. For tourist satisfaction, item two scored the highest mean with 4.20 where respondents strongly agree their vacation at Perhentian Island is satisfying and provides sweet moments that influence their loyalty to revisit that place at another time. Item three, on the other hand, score the lowest mean where respondents agree that they are satisfied with their vacation in Perhentian Island. Service quality, items five and seven scored the same highest mean with 4.03 where respondents agree that the services at Perhentian Island such as clear and understandable signs and information symbols and cleanliness of the hotel are the factors that influence them to revisit

Perhentian Island. Item four scored the lowest mean with 3.80 indicating that respondents agree to the honesty of the sellers when they are shopping at Perhentian Island. Destination loyalty, item 3 scored the highest mean with 4.27 where respondents strongly agree that they will recommend Perhentian Island to others. Item four scored the lowest mean value with 4.08 indicating that respondents agreed that Perhentian Island has fulfilled their expectations during their visits.

### Result of Pearson Correlation Coefficient Analysis

Table 14: Summary of the hypothesis testing in this study

Hypothesis	Pearson's correlation results	
H <sup>1</sup> : There was a positive relationship between destination attractiveness and destination loyalty.	r = 0.645, p < 0.01	Strong
H <sup>2</sup> : There was a positive relationship between place attachment and destination loyalty.	r = 0.779, P < 0.01	Strong
H <sup>3</sup> : There was a positive relationship between tourist satisfaction and destination loyalty.	r = 0.775, p < 0.01	Strong
H <sup>4</sup> : There was a positive relationship between service quality and destination.	r = 0.668, p < 0.01	Strong

Hypothesis 1 (H1) p-value was 0.001, which was less than a significant level of 0.01. The correlation coefficient of 0.645 recommended a moderate correlation between destination attractiveness and destination loyalty.

Hypothesis 2 (H2) p-value was 0.001, which was less than a significant level of 0.01. The correlation coefficient of 0.779 recommended a high positive correlation between place attachment and destination loyalty.

Hypothesis 3 (H3) p-value was 0.001, which was less than a significant level of 0.01. The correlation coefficient of 0.775 recommended a high positive correlation between tourist satisfaction and destination loyalty.

Hypothesis 4 (H4) p-value was 0.001, which was less than a significant level of 0.01. The correlation coefficient of 0.668 recommended a moderate correlation between service quality and destination loyalty.

## DISCUSSION AND RECOMMENDATION

The study examined the connections between Perhentian Island's attractiveness as a travel destination and factors like place attachment, visitor satisfaction, service quality, and destination

loyalty. In Perhentian Island, Terengganu, Malaysia, domestic visitors are being studied in order to determine the relationship between destination attractiveness, place attachment, tourist satisfaction, service quality, and destination loyalty.

The study suggests to tourism stakeholders that the administration of Malaysia's tourist sector needs to be aware of these characteristics and behaviours in order to maintain Perhentian Island position as the country's top island destination. In order to attract domestic tourists, they should take their preferences into consideration. Tour managers and operators risk misunderstanding market developments and ineffective resource allocation if they focus solely on foreign tourists.

In addition, the attraction of the site and having a sufficient budget might make Perhentian Island a more appealing tourist destination and impact satisfaction and intention to return. The tourist region needs stakeholders to keep up its enhancement efforts in terms of providing more alluring sites and attractions.

Furthermore, unique locations to explore will entice visitors to stay longer and spend more. Domestic tour companies and small businesses will profit from the additional revenue. There can therefore be no doubting the long-term impact which is going to benefit the tourism industry. Additionally, the entire nation gains both economically and can have an efficient growth in earnings.

Finally, for subsequent investigations, researchers might decide to use qualitative methods for collecting data because using an alternate method is done to see if the results are different from earlier studies in any way. For instance, using a qualitative approach may result in the researchers not receiving particular data, but they are more likely to acquire correct data.

## CONCLUSION

In conclusion, it was found that elements like destination loyalty, place attachment, tourist satisfaction, and service quality had an impact on domestic travellers' loyalty to Perhentian Island in Terengganu, Malaysia. Based on the data gathered, all of the respondents responded to the surveys based on their loyalty and experience while visiting Terengganu's Perhentian Island. The outcomes and conclusions of this study also revealed that the majority of the respondents firmly agreed that Perhentian Island, Terengganu, Malaysia's Perhentian Island had a substantial impact on destination loyalty, particularly in terms of destination attractiveness, place attachment, visitor satisfaction, and service quality.

## REFERENCES

- Akter, M., Sadekin, M. N., & Patwary, A. K. (2020). An Empirical Study on Students' Satisfaction from Mawlana Bhashani Science & Technology University, Bangladesh. *Review of Economics and Development Studies*, 6(2), 363-379.
- Almeida-Santana, A., & Moreno-Gil, S. (2018). Understanding tourism loyalty: Horizontal vs. destination loyalty. *Tourism Management*, 65, 245–255. <https://doi.org/10.1016/j.tourman.2017.10.011>
- Alom, S., Patwary, A. K., & Khan, M. M. H. (2019). Factors affecting the turnover intention of Bangladeshi migrants in the United Arab Emirates: An empirical study on the hotel industry. *International Journal of Innovation, Creativity and Change*, 8(3), 344-360.

- Chenini , A, & Touaiti, M. (2018). Building Destination Loyalty Using Tourist Satisfaction and Destination Image: A Holistic Conceptual Framework. *Journal of Tourism, Heritage & Services Marketing*, 4(2), 37–43.
- Cossío-Silva, F. J., Revilla-Camacho, M. Á., & Vega-Vázquez, M. (2019). The tourist loyalty index: A new indicator for measuring tourist destination loyalty? *Journal of Innovation and Knowledge*, 4(2), 71–77. <https://doi.org/10.1016/j.jik.2017.10.003>
- Fengmin, Z., Baijun, W., Jiangtao, B., Li, L., & Patwary, A. K. (2022). Investigating revisit intention of medical tourists in China through nutritional knowledge, perceived medical quality, and trust in the physiologist: A recommendation on health tourism policy measures. *Frontiers in Public Health*, 10, 893497.
- Hazbar, A. M. H., Alem Mohammed, A., & Karim, A. K. A. (2019). An Empirical Study of Factors Influencing hotel customers' online booking Intention. *مجلة العلوم التربوية و الدراسات الإنسانية*, (5), 1-17.
- Hosany, S., Prayag, G., Van Der Veen, R., Huang, S. (Sam), & Deesilatham, S. (2017). Mediating Effects of Place Attachment and Satisfaction on the Relationship between Tourists' Emotions and Intention to Recommend. *Journal of Travel Research*, 56(8), 1079–1093. <https://doi.org/10.1177/0047287516678088>
- Io, M. U., & Wan, P. Y. K. (2018). Relationships between tourism experiences and place attachment in the context of casino resorts. *Journal of Quality Assurance in Hospitality & Tourism*, 19(1), 45-65.
- LEMY, D. M., NURSIANA, A., & PRAMONO, R. (2020). Destination Loyalty Towards Bali. *Journal of Asian Finance, Economics and Business*, 7(12), 501–508. <https://doi.org/10.13106/JAFEB.2020.VOL7.NO12.501>
- Li, L., Ragavan, N. A., Patwary, A. K., & Baijun, W. (2022). Measuring patients' satisfaction toward health tourism in Malaysia through hospital environment, nutritional advice, and perceived value: A study on Chinese exchange students. *Frontiers in public health*, 10, 893439.
- Li, L., Wu, B., & Patwary, A. K. (2022). How marine tourism promote financial development in sustainable economy: new evidences from South Asia and implications to future tourism students. *Environmental Science and Pollution Research*, 29, 1155-1172.
- Li, L., Wu, B., & Patwary, A. K. (2022). The psychosocial factors affecting chinese Outbound Exchange and mobility students' academic performance during COVID-19. *Frontiers in psychology*, 13, 872516.
- Lv, X., Li, C. (Spring), & McCabe, S. (2020). Expanding theory of tourists' destination loyalty: The role of sensory impressions. *Tourism Management*, 77(May 2019), 104026. <https://doi.org/10.1016/j.tourman.2019.104026>
- Mayo EJ, Jarvis LP (1981) *The psychology of leisure travel: Effective marketing and selling of travel service*. CBI, Boston.
- Mohamad, M., Nasir, M. N. M., Ab Ghani, N. I., & Afthanorhan, A. (2019). Parallel mediators of place attachment and tourist satisfaction in destination attractiveness, destination loyalty and service quality. *International Journal of Innovation, Creativity and Change*, 7(7), 228–256.
- Moore, S. A., K. Rodger, and R. H. Taplin. 2017. "Developing a Better Understanding of the



Complexities of Visitor Loyalty to Karijini National Park, Western Australia.” *Tourism Management* 62:20–28.

- Patwardhan, V., Ribeiro, M. A., Payini, V., Woosnam, K. M., Mallya, J., & Gopalakrishnan, P. (2020). Visitors’ Place Attachment and Destination Loyalty: Examining the Roles of Emotional Solidarity and Perceived Safety. *Journal of Travel Research*, 59(1), 3–21. <https://doi.org/10.1177/0047287518824157>
- Patwary, A. K., Roy, B., Hoque, R., & Khandakar, M. S. A. (2019). Process of developing a community based tourism and identifying its economic and social impacts: An Empirical study on Cox’s Bazar, Bangladesh. *Pakistan Journal of Humanities and Social Sciences*, 7(1), 1-13.
- Sangpikul, A. (2018). The effects of travel experience dimensions on tourist satisfaction and destination loyalty: The case of an island destination. *International Journal of Culture, Tourism and Hospitality Research*.
- Sumethokula, P., Patwary, A. K., Srinuanpanc, B., Srinuanpand, C., Suwandee, P., Thammathikul, A., & Phanong, W. (2020). The potential of new tour repackaging for creative tourism among entrepreneurs in Nakhon Si Thammarat. *International Journal of Innovation, Creativity and Change*, 13(10), 1752-1771.
- Suntikul, W., & Jachna, T. (2016). The co-creation/place attachment nexus. *Tourism Management*, 52, 276–286. <https://doi.org/10.1016/j.tourman.2015.06.026>
- Wu, B., Liu, S., Wang, J., Tahir, S., & Patwary, A. K. (2021). Assessing the mechanism of energy efficiency and energy poverty alleviation based on environmental regulation policy measures. *Environmental Science and Pollution Research*, 28, 40858-40870.
- Wu, B., Zhai, B., Mu, H., Peng, X., Wang, C., & Patwary, A. K. (2021). Evaluating an economic application of renewable generated hydrogen: A way forward for green economic performance and policy measures. *Environmental Science and Pollution Research*, 1-15.
- Yin, J., Cheng, Y., Bi, Y., & Ni, Y. (2020). Tourists perceived crowding and destination attractiveness: The moderating effects of perceived risk and experience quality. *Journal of Destination Marketing & Management*, 18, 100489.
- Yuksel, A., Yuksel, F., & Bilim, Y. (2010). Destination attachment: Effects on customer satisfaction and cognitive, affective and conative loyalty. *Tourism Management*, 31(2), 274–284. <https://doi.org/10.1016/j.tourman.2009.03.007>
- Zeng, L., & Yi Man Li, R. (2021). Tourist satisfaction, willingness to revisit and recommend, and mountain kangyang tourism spots sustainability: A structural equation modelling approach. *Sustainability*, 13(19), 10620.
- Zhang, H., X. Fu, L. A. Cai, and L. Lu. 2014. “Destination Image and Tourist Loyalty: A Meta-Analysis.” *Tourism Management* 40:213–223.
- Zhang, J., & Walsh, J. (2021). Tourist experience, tourist motivation and destination loyalty for historic and cultural tourists. *Pertanika Journal of Social Sciences and Humanities*, 28(4), 3277-3296.

# Factors Influencing the Supply of Pineapples in Johor, Malaysia

Wan Nur Nadiana Izati Bt Wan Moktar, Wan Nurazyah Shafiqah bt Wan Rospaiza, Wan NuurAllifa binti Mohad Salleh, Wong Suet Theng & \*Siti Seliha binti Che Hasan\*.

Faculty of Hospitality, Tourism and Wellness, University  
Malaysia Kelantan  
Corresponding email:  
[selihah.ch@umk.edu.my](mailto:selihah.ch@umk.edu.my)

---

## ABSTRACT

*The pineapple (Ananas comosus) is the most economically vital plant of the bromeliad household and is a tropical plant suitable for eating fruit. This study was conducted to investigate the factors influencing the supply of pineapples in Johor, Malaysia. The independent variables in this study were farming experience, farm size, price of pineapple and cost of inputs, while the dependent variable was the quantity of pineapple supplied in Johor, Malaysia. This study had four objectives to investigate the factor farming experience in relation to the quantity of pineapple supplied in Johor, Malaysia, to analyse the farm size in relation to the quantity of pineapple supplied in Johor, Malaysia, to investigate the factor price of pineapple in relation to the quantity of pineapple supplied in Johor, Malaysia, and to investigate the factor cost of inputs in relation to the quantity of pineapple supplied in Johor, Malaysia. A questionnaire was used as the research instrument for data collection, and a quantitative research approach was used. In this study, a baseline sample of 103 respondents was collected and studied. A Google form was used for data collection. The results show that all the independent factors (farming experience, farm size, price of pineapple and cost of inputs) examined in this study have significant relationship with the dependent variable (quantity of pineapple supplied in Johor Malaysia) among Pontian farmers. This study will help to identify the factors influencing the quantity of pineapple supplied in Johor Malaysia, as well as provide a better understanding and knowledge of farming experience, farm size, price of pineapple and cost of inputs.*

**Keywords:** Quantity of pineapple, Farming Experience, Farm size, Price of pineapple, Cost of inputs

## INTRODUCTION

Pineapple is regarded as an economically significant horticulture product with significant health advantages and attractive sales potential in the worldwide market for foreign exchange profits, resulting in increased revenue for farmers. The pineapple market in Malaysia was decreasing day by day. This is because of Malaysia experiencing fierce competition with foreign countries such as Thailand, and Myanmar. Previous research on the pineapple industry in Malaysia centred mainly on chemical factors. However, several factors are involved in the decline of the pineapple market. One of them is the limited number of farmers. Many rural farmers in Malaysia suffer from the economy in light of the pineapple's market. It has proven when the whole country must witness the cases of fruit market decline, especially the pineapple now in 2022. This issue should be highlighted because it clearly shows that the collapse of the pineapple market is a big issue and it can have a bad impact for the national economy. The result of the study is helpful for farmers, traders and service providers involved in the production and marketing of fruits in the study area. In addition, the findings of the study also provide information for policy makers with a view of the whole market system that can be used as a frame-work how to formulate fruit marketing development programs and improve

efficiency of the fruit marketing system. Furthermore, the study can be used as references for further research.

Several objectives of this study were established as follows:

4. To examine the farming experience factor towards the quantity of pineapple supplied in Johor, Malaysia.
5. To analyse farm size towards the quantity of pineapple supplied in Johor, Malaysia.
6. To investigate the price of pineapple factors towards the quantity of pineapple supplied in Johor, Malaysia.
7. To examine the cost of inputs factors towards the quantity of pineapple supplied in Johor, Malaysia.

## SIGNIFICANCE OF THE STUDY

Despite being a significant national export, commercial varieties of pineapple have not yet been thoroughly studied and compared in terms of their physical, chemical, biological, and organoleptic qualities. The aim of this study was to determine and compare the physicochemical parameters, bioactive substances, antioxidant capacities, enzymatic activity, and sensory traits of various commercial pineapple cultivars in Malaysia. The goal of this study is to increase pineapple consumption based on the nutritional value of different commercial cultivars of pineapple, facilitate the marketing of cultivars with known fruit qualities and potencies, and provide useful data for future hybridization among these cultivars.

## LITERATURE REVIEW

### Quantity supply

The range of products or services that suppliers produce and promote at a given market charge is known as the quantity supplied. Price fluctuations decide how a great deal supply producers absolutely deliver to the market, subsequently the supply quantity differs from the proper supply quantity. The rate elasticity of supply describes how supply fluctuates in response to rate changes. (Will Kenton, 2021).

### Price Of Pineapple

Price is the value or money that customers give up in return for a particular item that meets their needs and wants. Prices are an economic mechanism for distributing offers to customers in the market. They also serve as an indicator of how much a supply is in demand and how much it is offered or available. A product's price is the overall value of the supply, which includes the cost of raw materials and services needed to manufacture the supply. The pricing of a service takes into account all the factors that contribute to making the service what it is. (Siddhi Kamble, 2022).

### Experience

Experience is defined as information or insight gained through practical participation in an action or event. This is usually different from the kind of theoretical knowledge gained through reading books or obtaining factual information. (Yogapedia, 2022)

## RESEARCH HYPOTHESIS

The literature review highlighted independent variables like farming experience, price of pineapple, farm size and cost of inputs affecting quantity of pineapple supplied in Johor, Malaysia. Based on the literature discussed, the hypotheses of this study were summarized in the following manner:

H1: There is a significant relationship between farming experience and the quantity of pineapple supplied in Johor, Malaysia.

H2: There is a significant relationship between the farm size and the quantity of pineapple supplied in Johor, Malaysia.

H3: There is a significant relationship between the price of pineapple and the quantity of pineapple supplied in Johor, Malaysia.

H4: There is a significant relationship between cost of inputs and the quantity of pineapple supplied in Johor, Malaysia.

## RESEARCH FRAMEWORK

The Figure 1 below shows the research framework used for this study.

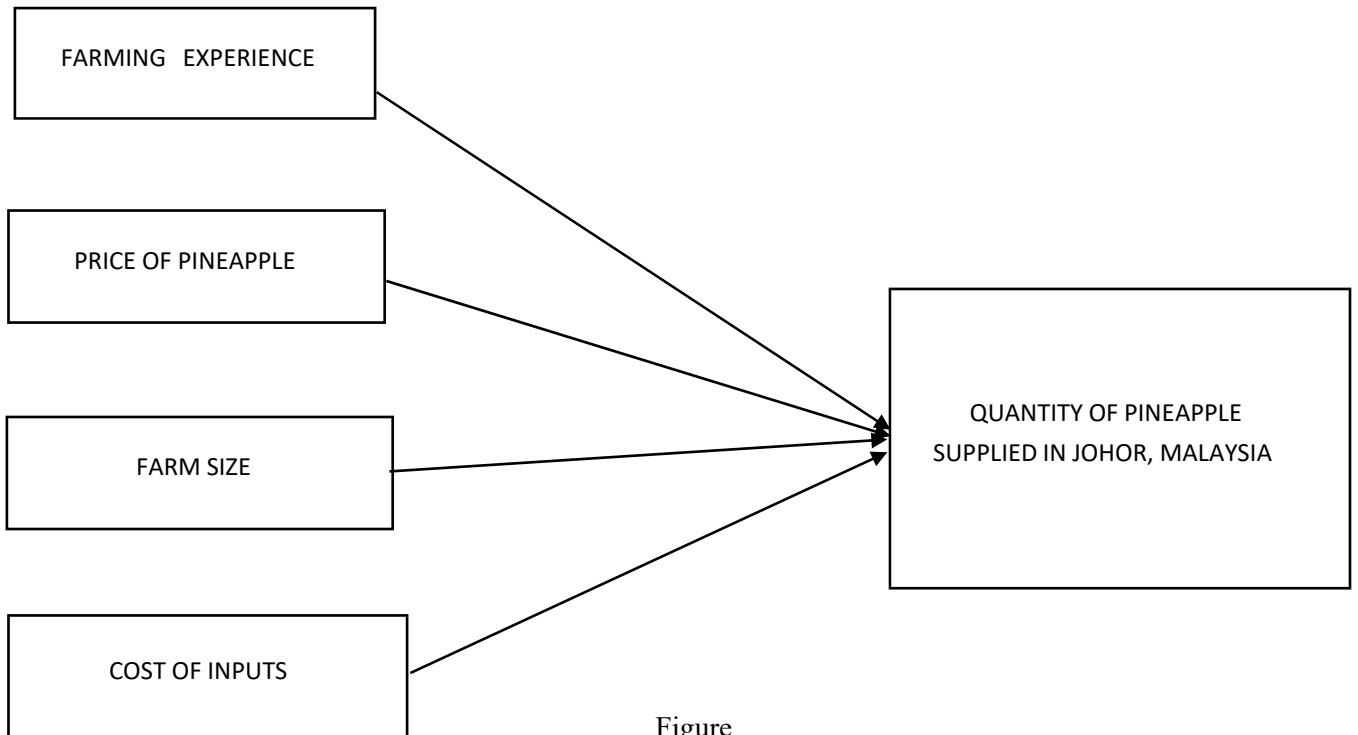

## METHODOLOGY

### Research Design

This study uses a quantitative method. The design of this study can be divided into three types: descriptive, exploratory and causal. The project investigates why. The goal of this research is to understand how the connection among dependent and independent factors affects current norms together with assumptions.

A cross-sectional technique was used to collect data for this investigation. This type of study is beneficial because it gathers information about correlations between factors at a specific moment in time. Surveys can be utilized for this purpose because they are relatively cheap and take very little time.

### Data Collection

The major data gathering strategy in this study was a questionnaire survey. The questionnaire was passing by online. Surveys are generally considered a reliable and effective method of gathering quantitative information from large populations in a brief period of duration. In addition, self-administered questionnaires can quickly collect a large amount of information from many respondents without the need for observers. Therefore, questionnaires will be used to collect data for this study.

### Target Population

The word "population is a collection of individuals, occurrences, or things that are fascinating about which researchers want to learn more (Kumar, 2013; Memon et al., 2020). Therefore, Pontian farmers were picked at random from a list of registered pineapple farmers in Pontian, Johor, by the Malaysian Pineapple Industry Board (MPIB).

The fast increase of the world populace and growing purchaser attention of the fitness advantages of fruits have led to a global extend in demand for fruits (Reid and Buisson, 2001; Sabbe et al., 2008). This advancement

generated an enormous chance to raise the fruit zone's contribution to gross national income (GNI) and improving incomes for farmers. Pineapple represents a strategically placed fruit among all fruits due to the alternate is aimed to industrialized nation such as Japan, the United States, and the European Union. (Coveca, 2002).

### Sample Size

A sample is a group of respondents chosen as most representative of the general population. To get an accurate picture or improve confidence, sample size is critical. Sample size helps to understand a group of individuals selected from the wider community that is believed to accurately reflect the population under study. Sample size is usually determined by population. 103 of pineapple farmers will be chosen through random sampling from the Malaysian Pineapple Industry Board (MPIB) listing of registered pineapple farmers in Pontian, Johor. The study sample (n=140) was determined as in accordance with Krejcie and Morgan (1970) to obtain an appropriate sample size.

### Sampling Method

The fourth step is to calculate the sample size. A random sample must have an acceptable size so that it can be generalized and to avoid sampling error or bias. The fifth step is data collection. The next stage is to gather data after selecting the target population, sampling frame, sampling process, and sample size. Response rate testing is the final stage of sample collection. The number of people that volunteered to participate in this study is referred to as the response rate.

### Data Analysis

In this study, descriptive statistics are used to characterize the data and describe its essential characteristics. Descriptive statistics, according to Gupta et al. (2019), provide straightforward descriptions of the sample and the measures. On the other hand, the researchers also use Pearson's Correlation Coefficient Analysis in this study. Correlation is to identify both the independent and dependent variables and is a test to show whether there is a relationship between both variables. Besides that, the researcher utilized Cronbach's alpha to assess the accuracy of the questionnaire results and the quality of the output. Both dependent and independent variables were studied based on Cronbach's alpha coefficient. Therefore, the researchers had been utilized the version 28.0 of the Statistical Package for Social Science (SPSS) to analyze the data.

## FINDINGS

### Profile of Respondents

Demographic	Categories	Frequency (N)	Percentage (%)
AGE	21-30 years	30	29.1 34.0
	31-40 years	40	36.9
	years above	38	
RELIGION	Muslim	48	46.6 13.6
	Christianity	14	14.6
	Hinduism	15	25.2
	Buddhism	26	

ETHNICITY	Malay	50	48.5	37.9
	Chinese	39		13.6
	Indian	14		
MARITAL STATUS	Single	38	36.9	47.6
	Married	49		6.8
	Divorced	7		8.7
	Widow	9		
LEVEL EDUCATION	Pmr/pt3 Spm	18	17.5	43.7
	Diploma	45		16.5
	Degree	17		21.4
	Master	22		1.0
		1		

Table 1: Demographic Analysis

Table 1 shows 103 profiles of the respondents and most of them are at the age of 40 years above which is 36.9% from the total of the sample. The lowest frequency respondents' age is 21-30 years with 29.1%. Meanwhile for ethnicity, the highest respondents are Malay with 48.5%. The race of Indians has the lowest frequency which is 13.6%. For marital status, most of the respondents are single with 47.6% and married respondents only 36.9% of them. As for the level of education stated that 43.7% of SPM students are the majority total respondents out of 1.0% is the lowest frequency of the respondents that are MASTER students. Thus, the data accurately reflect the real demographic compilation of the factors influencing the supply of pineapples in Johor, Malaysia

Table 2: Descriptive Analysis

VARIABLE	ITEMS	N	MEAN	STANDARD DEVIATION
Farming Experience	Pineapple farming faces challenges such as weather conditions, pests and diseases that can affect crop yields.	103	3.92	0.871
	Pineapple farming requires access to proper agricultural resources such as land, water and seeds in order to grow pineapples efficiently.	103	4.04	0.803



	Pineapple farmers must constantly learn and adapt to new growing methods and technologies.	103	4.07	0.889
--	--	-----	------	-------

	Pineapple farmers face social and economic challenges, such as land tenure issues and market access, that can impact their farming experience	103	3.86	0.864
	Pineapple farmers must constantly adapt their cultivation methods to adapt to changing market demands and consumer preferences.	103	3.96	0.791

Farm Size	The quantity of pineapple planting depends on the area (hectares) of the farm.	103	4.11	0.791
	Commercial and organic fertilizers used when growing pineapples will affect the quality of fruit	103	4.09	0.781
	The quantity of pineapple production depends on the type of soil used for planting.	103	4.11	0.726
	Pineapple cultivation is not too difficult because it can be planted in all types of soil.	103	3.99	0.975
	The size of the farm is not one of the reasons for the quality of pineapples to be damaged.	103	3.96	0.874
	The larger the farm area, the more pineapples the grower can produce.	103	4.17	0.678
Price of Pineapple	Pineapple prices according to the current market.	103	4.19	0.768
	The price of pineapple varies depending on the location and season.	103	4.00	0.767
	The price of pineapple may be affected by factors such as transportation costs, import and	103	4.06	0.739

	export tariffs and demand/supply dynamics.			
--	---	--	--	--

	Pineapple prices can fluctuate over time as due to changes in weather or disasters that influence pineapple production.	103	4.18	0.789
Cost of Inputs	The cultivation of pineapples requires considerable investment in land, labor and pesticides.	103	4.01	0.773
	Due to the costly expense of enhanced planting materials, I have resorted to traditional planting materials.	103	4.02	0.779

	I use family labor due to the high costs of labor.	103	4.10	0.786
	Pineapple production involves high transportation costs due to its perishable nature.	103	3.99	0.869
	One of the main aspects of pineapple production is ground preparation, for which suitable machinery is required.	103	4.13	0.776
	Each month, many machineries and energy will be utilized for pineapple cultivation.	103	4.07	0.889

Table 2 indicated the number of respondents, as well as the mean and standard deviation of the independent and dependent variables. The highest mean for the independent variables was the price of pineapple, which was 4.1092, followed by farm size, which was 4.0712, cost of inputs, which was 4.0518, and farming experience, which was 3.9709. The dependent variable's mean was 4.0558. Descriptive statistics are particularly important because they provide an easy overview of information in numbers and graphs. Descriptive statistics, in particular, is a technique for collecting data, processing data, describing and analysing all data. The most important aspect of descriptive statistics is that they express facts in the structure of data and aid in data understanding. In descriptive statistics, there are three important measurements. It is a central tendency measure, a variation measure, and a role measure.

Table 3: Reliability Analysis

Variable	Number of Items	Cronbach's Alpha Coefficient	Strength of Association
Farming Experience	5	0.894	Very Good
Farm Size	6	0.828	Very Good
Price of Pineapple	4	0.842	Very Good

Cost of Inputs	6	0.861	Very Good
Quantity of Pineapple Supplied	4	0.800	Very Good
<hr/>			
Overall Variables	25	0.902	Excellent

Table 4: Pearson Correlation Analysis

		<b>QUANTITY OF PINEAPPLE SUPPLIED IN JOHOR, MALAYSIA.</b>
Farming Experience	Pearson Correlation	.726
	Sig. (2-tailed)	.000
	N	103
Farm Size	Pearson Correlation	.647
	Sig. (2-tailed)	.000
	N	103
Price of Pineapple	Pearson Correlation	.792
	Sig. (2-tailed)	.000
	N	103
Cost of Inputs	Pearson Correlation	.683
	Sig. (2-tailed)	.000
	N	103

## Discuss Finding

This study suggests that further research can be done on factors influencing the supply of pineapples in Johor, Malaysia, as this study focused on pineapple growers to see if there is any correlation in the results. Therefore, some pineapple growers may also be able to answer this questionnaire.

Furthermore, the current study only focuses on factors influencing the supply of pineapples in Johor, Malaysia. However, this study may have overlooked some important factors that are also playing a role in disrupting the supply of pineapples in the Malaysian state of Johor. Therefore, researchers may recommend other variables, such as credit acquisition, to provide new insights for future research.

The study was also limited to a sample of 103, which can be classified as a small market. Therefore, future researchers should increase the sample size to improve the accuracy and reliability of the study.

Finally, instead of having respondents answer a scale questionnaire online, you can interview them or ask them an open-ended question. Using the interview method, researchers can obtain high response rates, resolve ambiguities, and follow up on partial answers immediately. In fact, this practice can help eliminate misconceptions and produce better research results.

## Conclusion

In a nutshell these variables have a significant and positive impact on pineapple supply in Johor, Malaysia. The findings of this investigation indicated that the price of pineapple influenced its supply. In simple terms, the study's goal of identifying the farming experience, farm size, cost of inputs, and price of pineapple that impact pineapple supply has been met.

This study advises that more research on variables impacting pineapple supply in Johor, Malaysia, be conducted, since this study focused on pineapple farmers to determine whether there is a correlation in the results. As a result, certain pineapple suppliers may be able to respond to this inquiry.

Furthermore, the current study focuses entirely on the factors influencing pineapple supply in Johor, Malaysia. This study, however, may have overlooked numerous key factors impacting pineapple supply in the Malaysian state of Johor. As a result, researchers may suggest that other variables, such as credit acquisition, be included in future study to give fresh insights.

## References

- Akter, M., Sadekin, M. N., & Patwary, A. K. (2020). An Empirical Study on Students' Satisfaction from Mawlana Bhashani Science & Technology University, Bangladesh. *Review of Economics and Development Studies*, 6(2), 363-379.
- Al Mahmud, S. R. (2020). The effectiveness of Facebook advertisements on purchase intention of customers in Malaysia. *South Asian Journal of Social Sciences and Humanities*, 1(1), 97-104.
- Alom, S., Patwary, A. K., & Khan, M. M. H. (2019). Factors affecting the turnover intention of

- Bangladeshi migrants in the United Arab Emirates: An empirical study on the hotel industry. *International Journal of Innovation, Creativity and Change*, 8(3), 344-360.
- Amar Ahmadi bin Thalip,. (2015, October). The MD2 ‘Super Sweet’ pineapple (*Ananascomosus*). Retrieved December 20, 2022, from <http://myagric.upm.edu.my/id/eprint/16559/1/TheMD2%28SuperSweet%29pineapple%28Ananascomosus%29-AmarAhmadbinThalip%2CTongP.S.andCaseyNg.pdf>
- Cag5Fk. (2015, November 16). Using and Interpreting Cronbach’s Alpha | University of Virginia Library Research Data Services + Sciences. Retrieved January 9, 2023, from <https://data.library.virginia.edu/using-and-interpreting-cronbachs-alpha/>
- Fengmin, Z., Baijun, W., Jiangtao, B., Li, L., & Patwary, A. K. (2022). Investigating revisit intention of medical tourists in China through nutritional knowledge, perceived medical quality, and trust in the physiologist: A recommendation on health tourism policy measures. *Frontiers in Public Health*, 10, 893497.
- Hazbar, A. M. H., alem Mohammed, A., & Karim, A. K. A. (2019). An Empirical Study of Factors Influencing hotel customers' online booking Intention. *مجلة العلوم التربوية و الدراسات الإنسانية*, (5), 1-17.
- Kress,J.W.(2008,June 25).Poales|plant order. Encyclopedia Britannica. <https://www.britannica.com/plant/Poales>
- Li, L., Ragavan, N. A., Patwary, A. K., & Baijun, W. (2022). Measuring patients' satisfaction toward health tourism in Malaysia through hospital environment, nutritional advice, and perceived value: A study on Chinese exchange students. *Frontiers in public health*, 10, 893439.
- Li, L., Wu, B., & Patwary, A. K. (2022). How marine tourism promote financial development in sustainable economy: new evidences from South Asia and implications to future tourism students. *Environmental Science and Pollution Research*, 29, 1155-1172.
- Li, L., Wu, B., & Patwary, A. K. (2022). The psychosocial factors affecting chinese Outbound Exchange and mobility students’ academic performance during COVID-19. *Frontiers in psychology*, 13, 872516.
- Patwary, A. K., Roy, B., Hoque, R., & Khandakar, M. S. A. (2019). Process of developing a community based tourism and identifying its economic and social impacts: An Empirical study on Cox’s Bazar, Bangladesh. *Pakistan Journal of Humanities and Social Sciences*, 7(1), 1-13.
- Perangkaan\_buah\_2020.(2022,January 17).RetrievedDecember 28,2022,from <https://fliphtml5.com/flqg/bqdt/basic>
- Sampling Methods. (2022, April 17). Unacademy. Retrieved January 10, 2023, from<https://unacademy.com/content/jee/studymaterial/mathematics/sampling-methods/>
- Sumethokula, P., Patwary, A. K., Srinuanpanc, B., Srinuanpand, C., Suwandee, P., Thammathikulf, A., & Phanong, W. (2020). The potential of new tour repackaging for creative tourism among entrepreneurs in Nakhon Si Thammarat. *International Journal of Innovation, Creativity and Change*, 13(10), 1752-1771.
- Supply.(2022, November 27).Investopedia. Retrieved December23, 2022,from <https://www.investopedia.com/terms/s/supply.asp>
- Wu, B., Liu, S., Wang, J., Tahir, S., & Patwary, A. K. (2021). Assessing the mechanism of energy efficiency and energy poverty alleviation based on environmental regulation policy measures. *Environmental Science and Pollution Research*, 28, 40858-40870.
- Wu, B., Zhai, B., Mu, H., Peng, X., Wang, C., & Patwary, A. K. (2021). Evaluating an economic application of renewable generated hydrogen: A way forward for green economic performance and policy measures. *Environmental Science and Pollution Research*, 1-15.



# **TOURIST SATISFACTION TOWARDS BEACH TOURISM IN PANTAI CAHAYA BULAN KOTA BHARU, KELANTAN.**

Yap Siao Tong, Yusra Syahirah Binti Adnan, Zaifah Hanani Binti Zainuddin, Zati Bayani Binti Suri

\* Madam Siti Selihah Binti Che Hasan

*Faculty of Hospitality, Tourism and Wellness, Universiti Malaysia Kelantan*

*Corresponding email: [selihah.ch@umk.edu.my](mailto:selihah.ch@umk.edu.my)*

---

## **ABSTRACT**

*The industry of tourism plays a significant role in the nation's economic development and revenue generation which is an area's topography plays a significant role in whether or not it attracts tourists and in the state of Kelantan, there is a district called Pantai Cahaya Bulan. The determination of this study is about the tourist satisfaction towards beach tourism in Pantai Cahaya Bulan. This research takes place at Pantai Cahaya Bulan in Kelantan, which is to find out more about the geography factor, environmental surrounding, and tourist perception among domestic tourists who visit Pantai Cahaya Bulan. The excellent natural beach conditions that have drawn visitors from other states to our nation make beach tourism one of the industry's special draws. The objective of this study is to examine the relationship between geography factors, environmental surroundings and tourist perception towards beach tourism in Pantai Cahaya Bulan. Data will be collected through a questionnaire survey using convenience sampling and will be analyzed by the IBM Statistical Package for Social Science (SPSS). The findings of this study will indicate the tourist attribute that focuses on geography factor, environmental surrounding, and tourist perception in Pantai Cahaya Bulan.*

Keywords: Beach Tourism, Tourist Satisfaction, Perceived Value, Visitor Perception, Environment Surrounding.

## **INTRODUCTION**

---

This study's introduction is covered in the first chapter, which also provides a number of measurements on the study's background, issue statement, research questions, and objectives as well as its scope, importance, report structure, and summary. Beach tourism is one of oldest types of travel in existence. It is a popular type of travel both domestically and internationally. Contrary to popular belief, leisure and tourism play a crucial role in the growth of beaches' allu attraction to the beach. Although it seems that the 3 (sea, sun and sand) attract people to the beaches, research has shown the importance of the physical characteristics of the beaches. Large day trippers on trains, vacationing families, and other foreign tourists are presently driving one of the most well-liked forms of tourism. These trends have also extended to warmer beaches. Today's developed beach tourism, where an upscale lifestyle reflects the enjoyment of sun, sea and surf, is a relatively new but highly successful concept. This research takes place at Pantai Cahaya Bulan in Kelantan, one of the beaches in Kota Bharu Kelantan. A survey is conducted among tourists in Pantai Cahaya Bulan to find out their attitude

toward beach tourism. There were three objectives of this research. This type of recreation in coastal resorts does not necessarily come from an inescapable attraction to the beach. Although it seems that the 3 (sea, sun and sand) attract people to the beaches, research has shown the importance of the physical characteristics of the beaches. Large day trippers on trains, vacationing families, and other foreign tourists are presently driving one of the most well-liked forms of tourism. These trends have also extended to warmer beaches. Today's developed beach tourism, where an upscale lifestyle reflects the enjoyment of sun, sea and surf, is a relatively new but highly successful concept. This research takes place at Pantai Cahaya Bulan in Kelantan, one of the beaches in Kota Bharu Kelantan. A survey is conducted among tourists in Pantai Cahaya Bulan to find out their attitude toward beach tourism. There were three objectives of this research:

- i. To evaluate the relationship between geography factors toward beach tourism in Pantai Cahaya Bulan Kota Bharu, Kelantan.
- ii. To investigate the relationship between environmental surroundings toward beach tourism in Pantai Cahaya Bulan Kota Bharu, Kelantan.
- iii. To determine the relationship between tourist perception towards beach tourism in Pantai Cahaya Bulan Kota Bharu, Kelantan.

## **SIGNIFICANCE OF THE STUDY**

The importance of this study is that high visitor satisfaction is an effective marketing tactic. Tourists who are happy with their experiences are more inclined to tell others about them, resulting in positive word-of-mouth advertising. In addition to drawing more visitors and encouraging traveller loyalty, their happiness enhances the reputation and image of the place. Next, the local and national economies of many beach resorts are significantly influenced by tourism. Satisfied visitors are more likely to spend more on lodging, dining, shopping, and leisure pursuits, boosting local companies' profits. Maximising the financial advantages of beach tourism can be achieved by understanding the elements that affect visitor happiness. Tourists that are satisfied are more inclined to stay put and come back frequently. Tourism businesses can determine the elements that encourage return visits by looking at their satisfaction levels, such as the standard of the beach, cleanliness, safety, friendliness, and recreational options. Using this information, they can create plans to keep current customers and develop lasting connections with them. Studies on visitor satisfaction with beach travel offer additional insights into the effects of tourism on the environment and culture. Destinations may apply sustainable tourism practices, minimize negative effects, and conserve their attractions for future generations by learning how satisfied tourists are with sustainability practices, the preservation of natural resources, and respect for local cultures.

## **LITERATURE REVIEW**

Weather, water quality, lodging, landscape, and safety are just a few of the variables that have frequently been looked at in research on visitor satisfaction at beach resorts (Alegre and Cladera, 2006; Kozak, 2001; Yoon and Uysal, 2005). Recently, research on the significance of amenities and recreation in the visitor experience has begun (Frampton, 2009; McKenna et al., 2011; Williams and Micallef, 2009).

Because beach tourism and recreation have grown to be a significant contributor to the Gross Domestic Product (GDP) of many countries, visitor dissatisfaction with a beach can result in tourism decreases and economic loss. Facilities and leisure must also be included, according to Frampton (2009) and Klein and Dodds (2017b), in order to achieve comprehensive beach management.

### **Research Hypothesis**

Places like Pantai Cahaya Bulan, for example, are accessible to tourists. This is done so that visitors can see what makes Pantai Cahaya Bulan unique. As a natural environment, Pantai Cahaya Bulan is accessible at any time. Pantai Cahaya Bulan is frequently visited. As a result, the following served as the study's first hypothesis:

H1

There is a significant relationship between tourist satisfaction and tourist perception towards beach tourism in Pantai Cahaya Bulan, Kota Bharu Kelantan.

H2

There is a significant relationship between environmental surroundings and tourist perception towards beach tourism in Pantai Cahaya Bulan, Kota Bharu, Kelantan.

H3

There is a significant relationship between geography factor and tourist perception towards beach tourism in Pantai Cahaya Bulan, Kota Bharu, Kelantan.

### Research Framework

The Figure 1 below shows the research framework use for this study

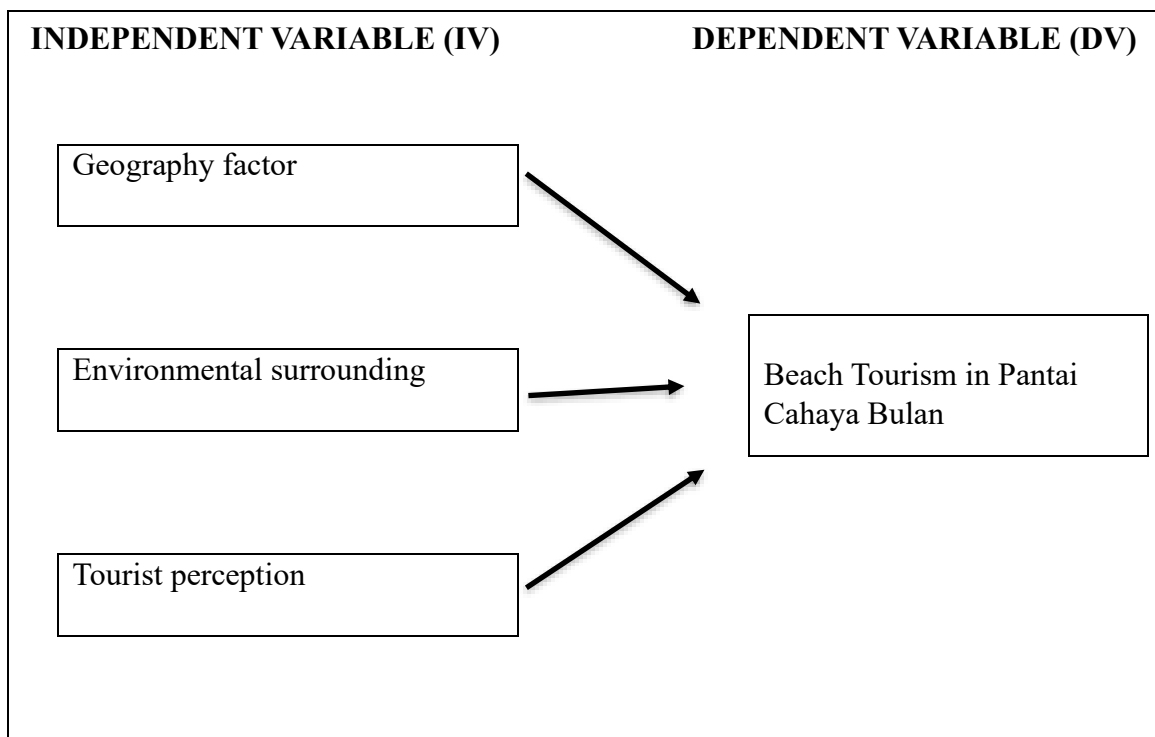

### METHODOLOGY

#### Research Design

For this study, the researcher will use a quantitative method. The quantitative approach is seen to be the most effective and used to collect the study's main data. Every organization needs quantitative

analysis to design ways to grow. A population is the collective group of individuals about whom we desire to render judgment. A sample is a specific group from whom we will collect data. Every time, the sample size is smaller than the whole population. To finish the study, a sample from the target population might be chosen. The study's target population consisted of visitors to Kelantan during the past three years. The survey targeted both domestic and international visitors who had been to Pantai Cahaya Bulan, and those who responded to the questionnaire had to be at least 19 years old. Our target population consisted of 384 domestic tourists.

### **Data Collection**

The major data source for this study was a questionnaire survey that was utilized to gather information from survey participants. Since we need a lot of data from a lot of individuals, questionnaires let us collect data quickly. The survey we used in this study offers a financial advantage. The questionnaire was made using a free Google form, making it far less expensive than alternative methods. The dependent and independent variables are used to split the set questionnaire into portions. Their names won't be used or kept a secret in this study in order to protect the respondents' identities. This is particularly true for quantitative data, which can result in databases that are more effective and efficient. We were able to find pertinent papers, dissertations, journals, and reports linked to the research online, making it possible for us to get the information more swiftly and affordably.

### **Sampling**

Due to the fact that samples are not chosen at random, the researcher will employ the non-probability technique. 384 tourists who have visited Pantai Cahaya Bulan are among the respondents. The non-probability convenience sampling strategy was selected to gather data for the report since it is quicker to locate the required data this way. This sample method is also simple to utilise and doesn't cost anything for this research. Visitors to Pantai Cahaya answered the questionnaire as respondents. They were chosen for this poll so that researchers could examine how satisfied they were with Pantai Cahaya Bulan. The questionnaire's respondents were chosen, and all data were gathered based on their responses.

### **Data Analysis**

These specialized methods for evaluating data include descriptive analysis, reliability testing, and inferential statistics. In quantitative data analysis, datasets are analysed statistically, mathematically, or numerically using computer and statistical techniques. Due to its usability and cutting-edge computing and data processing capabilities, IBM SPSS Statistics software was used to analyze the

survey results. The use of SPSS in the study helps to achieve the research objectives and helps to process the data that has been obtained. To examine the number of replies per question, the valid % (the percentage when missing data is omitted from the computations), and the cumulative percentage, we first enter all of our data into the SPSS application (Verma, J. P. 2012).

## **FINDINGS**

### **DISCUSSION AND RECOMMENDATION**

An effective research method for examining tourists' happiness with beach travel is a longitudinal study. Using this technique, researchers can gather data over a long period of time, examining changes and trends in tourists' levels of satisfaction as well as factors that affect their experiences. Longitudinal research starts by measuring visitor satisfaction at the outset. To gauge the first levels of satisfaction among beachgoers, researchers perform questionnaires or interviews. This serves as a baseline for comparisons made across the course of the research. Data collection is done over a period of months or years, often, for longitudinal investigations. When tourists visit the beach, researchers can occasionally administer questionnaires or conduct interviews with them. This makes it possible to gauge people's levels of satisfaction throughout their encounters.

Improving the local public amenities is crucial if it is to attract more tourists to visit Pantai Cahaya Bulan. Here's a thorough description of how improving basic services for the general people might draw more tourists. It is essential to improve the area's infrastructure around Pantai Cahaya Bulan. This includes enhancing parking facilities, guaranteeing efficient transportation to and from the beach, and enhancing road networks. Tourists may reach the area more easily thanks to handy transportation alternatives and well-maintained roadways. If Pantai Cahaya Bulan wants to draw in more visitors, it is imperative to upgrade the neighborhood's public amenities. Here is a detailed explanation of how enhancing fundamental services for the general public could increase tourism. The infrastructure in the area surrounding Pantai Cahaya Bulan must be improved. This includes ensuring prompt access to and from the beach, and improving road systems. Thanks to practical transit options and well-kept roads, tourists may access the area more readily.

An effective research method for examining tourists' happiness with beach travel is a longitudinal study. Using this technique, researchers can gather data over a long period of time, examining changes and trends in tourists' levels of satisfaction as well as factors that affect their experiences. Longitudinal

research starts by measuring visitor satisfaction at the outset. To gauge the first levels of satisfaction among beachgoers, researchers perform questionnaires or interviews. This serves as a baseline for comparisons made across the course of the research. Data collection is done over a period of months or years, often, for longitudinal investigations. When tourists visit the beach, researchers can occasionally administer questionnaires or conduct interviews with them. This makes it possible to gauge people's levels of satisfaction throughout their encounters.

Improving the local public amenities is crucial if it is to attract more tourists to visit Pantai Cahaya Bulan. Here's a thorough description of how improving basic services for the general people might draw more tourists. It is essential to improve the area's infrastructure around Pantai Cahaya Bulan. This includes enhancing parking facilities, guaranteeing efficient transportation to and from the beach, and enhancing road networks. Tourists may reach the area more easily thanks to handy transportation alternatives and well-maintained roadways. If Pantai Cahaya Bulan wants to draw in more visitors, it is imperative to upgrade the neighborhood's public amenities. Here is a detailed explanation of how enhancing fundamental services for the general public could increase tourism. The infrastructure in the area surrounding Pantai Cahaya Bulan must be improved. This includes ensuring prompt access to and from the beach, and improving road systems. Thanks to practical transit options and well-kept roads, tourists may access the area more readily.

## **CONCLUSION**

The findings of the questionnaire survey results are analysed using a variety of methods, including descriptive and inferential analysis.(2016) Taherdoost. Next, using the Statistical Package for the Social Science (SPSS) version 29 software programme, the findings from the preceding chapter and all of the questionnaire data were examined. The researchers utilised this software because it makes it simple to obtain results, including those of descriptive analyses and reliability tests. Last but not least, a final summary and conclusion based on the data analysis. All of the given hypotheses (H1, H2, and H3) are accepted for this study.

## **REFERENCES**

Ahmad, H., & Jusoh, H. (2018). Family-friendly beach tourism in Malaysia: either physical or man-made determinants. *Review of socio-economic perspectives RSEP*, 141.

- Akter, M., Sadekin, M. N., & Patwary, A. K. (2020). An Empirical Study on Students' Satisfaction from Mawlana Bhashani Science & Technology University, Bangladesh. *Review of Economics and Development Studies*, 6(2), 363-379.
- Alom, S., Patwary, A. K., & Khan, M. M. H. (2019). Factors affecting the turnover intention of Bangladeshi migrants in the United Arab Emirates: An empirical study on the hotel industry. *International Journal of Innovation, Creativity and Change*, 8(3), 344-360.
- Belotto, M. J. (2018). Data analysis methods for qualitative research: Managing the challenges of coding, interrater reliability, and thematic analysis. *The Qualitative Report*, 23(11), 2622-2633. Bhandari, P. (2020). A step-by-step guide to data collection. Retrieved November 14, 2020.
- Dodds, R., & Holmes, M. R. (2019). Beach tourists; what factors satisfy them and drive them to return. *Ocean & coastal management*, 168, 158-166.
- Fengmin, Z., Baijun, W., Jiangtao, B., Li, L., & Patwary, A. K. (2022). Investigating revisit intention of medical tourists in China through nutritional knowledge, perceived medical quality, and trust in the physiologist: A recommendation on health tourism policy measures. *Frontiers in Public Health*, 10, 893497.
- Frost, J. (2019). *Regression analysis: An intuitive guide for using and interpreting linear models*.
- Hazbar, A. M. H., Alem Mohammed, A., & Karim, A. K. A. (2019). An Empirical Study of Factors Influencing hotel customers' online booking Intention. *مجلة العلوم التربوية و الدراسات الإنسانية*, (5), 1-17.
- Kabir, S. M. S. (2016). Basic guidelines for research. An introductory approach for all disciplines, 4(2), 168-180. KÜLTÜRÜNE, S. D. K. Y. (2022). *Review of Tourism Administration Journal*.
- Lee, S. J., & Lina Kim, H. (2018). Roles of perceived behavioural control and self-efficacy to volunteer tourists' intended participation via theory of planned behaviour. *International Journal of Tourism Research*, 20(2), 182-190.
- Li, L., Ragavan, N. A., Patwary, A. K., & Baijun, W. (2022). Measuring patients' satisfaction toward health tourism in Malaysia through hospital environment, nutritional advice, and perceived value: A study on Chinese exchange students. *Frontiers in public health*, 10, 893439.
- Li, L., Wu, B., & Patwary, A. K. (2022). How marine tourism promote financial development in sustainable economy: new evidences from South Asia and implications to future tourism students. *Environmental Science and Pollution Research*, 29, 1155-1172.
- Li, L., Wu, B., & Patwary, A. K. (2022). The psychosocial factors affecting chinese Outbound Exchange and mobility students' academic performance during COVID-19. *Frontiers in psychology*, 13, 872516.
- McKercher, B., & Wong, D. Y. (2004). Understanding tourism behaviour: Examining the combined effects of prior visitation history and destination status. *Journal of Travel Research*, 43(2), 171-179.
- Mosbah, A., & Saleh, A. A. (2014). A review of tourism development in Malaysia. *European Journal of Business and Management*, 6(5), 1-9.
- Netto, A. P. (2009). What is tourism? Definitions, theoretical phases and principles. *Philosophical issues in tourism*, 37, 43-62.



- Patwary, A. K., Roy, B., Hoque, R., & Khandakar, M. S. A. (2019). Process of developing a community based tourism and identifying its economic and social impacts: An Empirical study on Cox's Bazar, Bangladesh. *Pakistan Journal of Humanities and Social Sciences*, 7(1), 1-13.
- Putri, H. E., Isrokatun, I., Majid, N. W. A., & Ridwan, T. (2019, October). Spatial sense instrument for prospective elementary school students. In *Journal of Physics: Conference Series* (Vol. 1318, No. 1, p. 012142). IOP Publishing.
- Stratton, S. J. (2021). Population research: convenience sampling strategies. *Prehospital and disaster Medicine*, 36(4), 373-374.
- Sumethokula, P., Patwary, A. K., Srinuanpanc, B., Srinuanpand, C., Suwandee, P., Thammathikul, A., & Phanong, W. (2020). The potential of new tour repackaging for creative tourism among entrepreneurs in Nakhon Si Thammarat. *International Journal of Innovation, Creativity and Change*, 13(10), 1752-1771.
- Taherdoost, H. (2016). Validity and reliability of the research instrument; how to test the validation of a questionnaire/survey in a research.
- Verma, J. P. (2012). *Data analysis in management with SPSS software*. Springer Science & Business Media.
- Wu, B., Liu, S., Wang, J., Tahir, S., & Patwary, A. K. (2021). Assessing the mechanism of energy efficiency and energy poverty alleviation based on environmental regulation policy measures. *Environmental Science and Pollution Research*, 28, 40858-40870.
- Wu, B., Zhai, B., Mu, H., Peng, X., Wang, C., & Patwary, A. K. (2021). Evaluating an economic application of renewable generated hydrogen: A way forward for green economic performance and policy measures. *Environmental Science and Pollution Research*, 1-15.

# **Awareness and Knowledge of Social Protection Among Gig Economy Workers in Kota Bharu, Kelantan.**

**Siti Aisyah Binti Azman, Siti Farzzanah Binti Kader Ibrahim, Siti Sarah Aqilah Binti Rudisham, Harini a/p Harikrishnan & \* Muhammas Firdaus Bin Bidin**  
*Faculty of Hospitality, Tourism and Wellness Universiti Malaysia Kelantan*

*Corresponding email: [mfirdaus.b@umk.edu.my](mailto:mfirdaus.b@umk.edu.my)*

---

## ***ABSTRACT***

*This study was conducted to analyze the awareness of social protection among the gig economy workers Kota Bharu, Kelantan. The primary purpose of this research is to examine the knowledge of social protection of gig economy workers in Kota Bharu, Kelantan. The selected qualitative analysis approach and the data collection method used was a personal semi-structured interview and eight respondents were involved. That is the main source of data used in the data collection method for this research. It is the easiest way to collect and gather the honest information from respondents for this research paper. The number of respondents is eight food delivery riders in the personal semi-structured interviews. Thus, this study can help other researchers in the future when they want to examine the knowledge of social protection of gig economy workers in Kota Bharu, Kelantan.*

**Keywords: Awareness, Knowledge, Social Protection, Gig Economy, Kota Bharu**

---

## **INTRODUCTION**

In a gig economy, independent workers are hired by business to fulfill temporary tasks rather than filling permanent positions. Transactions are task-ached, and the service industry employs the majority of people. Furthermore, signing long-term contracts is optional for the employees. Other names for the gig economy include peer, network, and on demand economies. On the surface, e-hailing and start-ups are critical in the gig economy. It compels many people to look for other jobs, especially in the gig economy. One of the best ways for unemployed people to make extra money or temporary income while they wait for permanent employment or for their country's economy to revive is through the gig economy platform. An autonomous or short-term contract labor market known as the "gig economy" is one in which individuals work for themselves and are aided by digital technologies.

Advertising by companies in the gig economy ecosystem is gaining popularity. P-hailing companies are creating various job opportunities, such as part-time advertising positions, contracts, and economic gigs during the Movement Control Order (MCO) period. The P-Hailing industry, similar to mushrooms sprouting after rain, has experienced significant growth due to

the pandemic. Malaysian P-Hailing market is flooded with companies like Food panda, Grab food, Bungkusit, Lalamove, and others. The Malaysian Ministry of Transport has registered over ten (10) P-Hailing companies recently, indicating a rapid increase in demand for the P-Hailing industry in Malaysia, especially during the pandemic, as stated in the TERAJU report (2021).

Social protection refers to the measures and policies put in place by governments and organizations to support individuals and communities in times of need or vulnerability. It aims to provide financial security, access to healthcare, and other social benefits to ensure the well-being of workers and their families. Furthermore, workers in the gig economy lack social protection, which encompasses various benefits such as pensions, social security, and access to programs like the Employees Provident Fund (EPF), Employment Insurance System (EIS), and medical coverage provided by the Social Security Organization (SOCSO). They are also excluded from entitlements like maternity leave and public holidays. Moreover, the prospect of being terminated without justification or not receiving severance pay is particularly distressing for these workers (Adzee Amir, 2022).

This chapter begins by providing an overview of Chapter 1, followed by an exploration of the study's background. Additionally, Chapter 1 delves into the problem statement related to the selected topic and highlights the necessity for conducting this research. Furthermore, it addresses the research questions and objectives. Subsequently, the chapter proceeds to outline the study's scope, significance, and the structure of the report. Finally, Chapter 1 concludes with a summary of the report.

This study aims to examine the level of awareness and knowledge of social protection among gig economy workers in Kota Bharu, Kelantan. The objectives of this research are:

4. To analyze the level of awareness of social protection among gig economy workers in Kota Bharu, Kelantan.
5. To examine the level of knowledge of the social protection of gig economy workers in Kota Bharu, Kelantan.
6. To propose recommendations for the gig economy workers in Kota Bharu, Kelantan.

## **Significance of the Study**

### **Gig Economy Workers**

With a focus on gig economy workers, specifically food delivery riders, we aim to examine the level of awareness and understanding regarding social protection among these workers. Additionally, we will underscore the significance of social protection for gig economy workers. For example, while the Social Security Organization (SOCSO) does not extend legal protection to gig workers, the Self-Employment Social Security (SESSS) does provide such coverage. Contributions to the Employment Provident Fund (EPF) are not made by employers,

and gig workers are required to make voluntary contributions to the retirement incentive program. However, the nature of their work exposes them to various risks, including workplace accidents and injuries. Consequently, gig workers should remain vigilant and aware of their rights and responsibilities during their working hours.

## **LITERATURE REVIEW**

### **Gig Economy**

A "gig" is the colloquial term for work held for a specific period. Musicians have long used the expression to describe live performances. Gig workers include individuals who work as project-based workers, impermanent or part-time labor, independent contractors, and freelancers employees. Gig applications and other digital technology frequently connect customers and gig workers stated by Amanda Yeo (2021). In the gig economy, there are employers, employees, and clients. Not every gig worker is created equally. Other compensated employees include part-time employees who are not employed full-time, self-employed individuals who complete tasks and deliver them under contract, and freelancers paid per task. Some temporary employees, independent contractors, project-based workers, and contractors may get project-by-project compensation as reported by Awani (2021).

According to the Awani (2021), the gig economy can enhance work-life balance from the employee's viewpoint compared to many traditional occupations. Freelance tasks that meet their tastes and schedules, give fresh prospects, and are attracted to them can be chosen by self-employed employees. They avoid being forced into a full-time position that doesn't suit them or offer the freedom they require. Additionally, these employees can choose their hours in the freelance economy, which keeps them from being dependent on a single employer.

### **Social Protections**

Social protection aims to reduce the impact of risks and vulnerabilities on individuals and households. It involves implementing critical health services and providing cash transfers worldwide. The term refers to a set of national guarantees that address poverty, vulnerability, social exclusion, and inequality. It includes both monetary and non-monetary benefits such as pensions, job perks, and assistance with expenses. In addition to financial aid, there are various measures like tax exemptions, Social Security payments, salary subsidies, and worker loans that improve access to social and health services. In-kind assistance and other benefits are also provided to enhance access to healthcare services.

### **Awareness of Social Knowledge Gig Workers Protection**

Awareness of social protection for gig workers, particularly those in the knowledge-based gig economy, is crucial. These workers often lack access to basic employment benefits like sick pay, paid vacation, and health insurance. They are vulnerable to exploitation and face challenges in negotiating fair compensation and working conditions. Raising awareness about the need for

social protection, advocating for policy changes, and educating gig workers about their rights and available resources are essential steps to address these issues and create a fair and inclusive work environment.

Additionally, because they are not eligible for sick pay, self-employed people may be pushed to labor through illness. Self-employment is therefore viewed as a milder variety of work. Self-employed people either may not qualify for certain job benefits like paid vacation and sick time or are not protected by work-related social protection programs like health insurance and pension insurance. According to the Department of Labour and Statistics (2021), there are four types of employment in the nation: salaried employees or people who work for others for money. Self-employed people, or people who work on their dime, unpaid contributing family members, or people who work in family businesses without getting paid, and employers who run companies with at least one employee (Department of Statistics of Malaysia, 2021).

Gig economy workers who are self-employed can relate to institutions such as the Employees Provident Fund (EPF) and the Social Security Organization (SOCSO) in terms of social security and insurance programs. However, there is a need for thorough studies and evaluations of the current programs to enhance social welfare among self-employed individuals while ensuring their protection. The existing legislation, such as the Self-Employed Social Security Act of 2017 (Act 789) and the Employment Insurance Scheme Act of 2017 (Act 800), should be revised to provide adequate safeguards for self-employed workers in the event of work-related accidents, illnesses, or loss of employment. Additionally, it is important to address the bureaucratic obstacles that prevent independent contractors from accessing essential benefits. By collaborating with government institutions like EPF and SOCSO, comprehensive reforms can be implemented to improve the social security and insurance coverage for gig economy workers who are self-employed, removing barriers and ensuring their well-being.

## **METHODOLOGY**

### **Research Design**

The research design informs the nature of the study and its organizational structure. The researcher will use a descriptive research approach to analyze the awareness and knowledge of social protection among gig workers in Kota Bharu, Kelantan. A qualitative research strategy will be employed to evaluate respondent perspectives and explore unique ideas more thoroughly. This approach is suitable for determining gig workers' awareness of their social rights and their actions in this study's context. Qualitative research focuses on understanding and explaining social processes, including meanings, motives, ambitions, beliefs, values, and attitudes. It encompasses a wide range of interactions, procedures, and events, going beyond operationalizing variables (Grossoehme, 2014).

## **Data Collection**

Data collection involves intentionally obtaining information on a specific subject, emphasizing the importance of ensuring the reliability and ethical compliance of the gathered data. The integrity of a study depends on the unique methods employed to collect quantitative or qualitative data, which can involve utilizing appropriate data-gathering tools and following precise instructions to minimize errors (Pritha Bhandari, 2020). Gathering data is a vital phase in any research project, and in this study, both primary and secondary data collection methods were employed. Primary data was obtained through personal semi-structured interviews with eight gigworkers in Kota Bharu, Kelantan, using open-ended questions. This data collection process lasted approximately three weeks. Additionally, secondary data from various sources, such as magazines, websites, books, journal articles, and newspapers, had already been collected and published.

## **Sampling**

In this study, a group of participants will be selected using a purposive sampling technique to gather data. The researcher will use their judgment to choose participants based on specific criteria. The focus of the study is on food delivery riders, specifically eight individuals, who work in the gig economy in Kota Bharu, Kelantan. By narrowing down the participants to food delivery riders, the research aims to gain in-depth insights into their experiences, challenges, and perspectives. The study intends to utilize personal semi-structured interviews as an effective method to collect qualitative data from these selected food delivery riders. This approach ensures that the study captures valuable information and provides a comprehensive understanding of the gig work in the context of food delivery in Kota Bharu, Kelantan. The sampling technique helps optimize the study's efficiency, accuracy, and cost-effectiveness, ultimately contributing to the overall quality of the research findings.

## **Data Analysis**

Data analysis involves collecting, manipulating, cleaning, and modeling data to uncover the desired information. Sharing the results facilitates interpretation and decision-making, often through data visualization. The terms "data analysis" and "data modeling" are interchangeable. The reliability of research depends on collecting reliable data, regardless of the subject or the chosen quantitative or qualitative data definition methods. Using appropriate data collection technologies and clear instructions helps reduce errors. Data collection is a crucial phase in any research endeavor.

In a study on social protection awareness and knowledge among gig workers in Kota Bharu, Kelantan, eight gig economy employees were interviewed in person using semi-structured interviews. Four students conducted these interviews, which took approximately one week to complete and provided valuable insights into gig workers' understanding of social protection. Primary data was collected directly from the participants through experiments, surveys, interviews, and observations. Primary data offers advantages as it is specific and aligns

with the researchers' needs, allowing them to clarify their objectives, goals, and justifications. Semi-structured interviews allowed researchers to gather additional information about respondents' daily activities related to the topic. Primary research provides more control, including decisions about study participants, recruitment practices, sample size, and sampling techniques.

## FINDINGS

### Analysis of Theme 1

Table 1 below shows the Analysis Theme 1

Table 1: Analysis of Theme 1

Respondent Question	Interview's Transcription (8 respondents)	Theme
<p>What is social protection and how related to food delivery rider?</p>	<p><b>R1:</b> Social protection is essential for food delivery riders because we don't have a fixed salary or benefits like sick leave or health insurance. We are often classified as independent contractors.</p> <p><b>R2:</b> I think social protection is very important especially for female gig workers. The purpose is to protect our rights and ensure our well-being in this employment sector.</p> <p><b>R3:</b> If we apply for social protection, we can guarantee to get money for treatment and compensation in the event of an accident involving the loss of life. social protection also provides additional benefits such as financial assistance for rehabilitation costs and emotional support.</p> <p><b>R4:</b> Protection in the event of an accident is essential because the consequences of an accident can disrupt the family's income. Having social protection measures in place becomes crucial as it ensures a safety net, offering financial support and assistance during these challenging circumstances.</p>	<p>The level of awareness of social protection among gig economy workers</p>

	<p><b>R5:</b> Social protection, such as life insurance, is an invaluable safeguard for someone like me. It would provide crucial assistance to not only myself but also my family.</p> <p><b>R6:</b> In my view, social protection serves as a contingency plan for individuals confronted with unexpected emergencies. Consequently, I do not believe it necessary to acquire social protection, such as insurance, as I have diligently saved funds and possess greater confidence in my own ability.</p> <p><b>R7:</b> These highly delivery riders think that they did not have any social security coverage and aren't aware of all of their rights. They do not have any form of social safety net, be it life and health insurance, emergency savings, insurance against social setbacks or retirement savings.</p> <p><b>R8:</b> They work under vulnerable conditions and suffer from a lack of comprehensive social protection mechanisms while at work. These gig workers are not covered by the existing employment-related social protection system.</p>	
--	--	--



## Analysis of Theme 2

Table 2 below shows the analysis theme 2

Table 2: Analysis of Theme 2

<b>Respondent Question</b>	<b>Interview's Transcription (8 respondents)</b>	<b>Theme</b>
<p>Steps can you take to ensure you are enrolled in the social protection programs that meet your specific needs as a food rider?</p>	<p><b>R1</b> : The first step is to research and identify the most relevant programs to our needs. Once we've identified these programs, we should check if we meet the eligibility criteria and apply accordingly.</p> <p><b>R2</b> :The first step is addressing the situation. We can initiate networking with fellow food riders, participate in training sessions or workshops that offer insights on social protection, and actively seek information from relevant government agencies. Additionally, joining or establishing associations can facilitate negotiations for improved terms and conditions with food delivery platforms and provide collective bargaining power.</p> <p><b>R3</b> : Although I am unsure about the specific steps I should take, I can consult the Food panda application to gather the relevant information needed.</p> <p><b>R4</b> : The company imposes certain obligations and requirements on all workers, including safety protocols, service standards, and compliance with company</p> <p><b>R5</b> : It is crucial to choose a policy that offers comprehensive</p>	<p>The level knowledge of social protection among gig economy workers</p>

	<p>coverage and brings advantages in multiple aspects, all while remaining affordable.</p> <p><b>R6 :</b> The first step I can begin, by establishing connections with other food riders, participating in training sessions or workshops that educate participants about social protection, and proactively requesting information from pertinent government authorities.</p> <p><b>R7 :</b> These benefits include the SOCSO work accident insurance, participation in a voluntary retirement savings program through i-Saraan under the EPF, and a housing credit guarantee.</p> <p><b>R8 :</b> I am determined to actively explore and collect information regarding social protection policies and what they provide. I am motivated to delve into this subject and conduct thorough research in order to gain a better understanding</p>	
--	--	--

**Finding Theme 1**

Table 3 below the result Findings of Theme 1

Table 3: Findings of Theme 1

No	Finding of Awareness of social protection among gig economy workers	Interviewer's Transcription
----	---	-----------------------------

1	What is social protection and how related to food delivery riders?	<i>Respondent 7 is a male food rider in the age range of 25 to 34 years old, working full-time. His monthly income is approximately between RM 2000 and RM 2499, and he has previously received benefits from social protection. Social protection is playing a big role in gig riders who work permanently. I think the most delivery riders are</i>
---	--	---

		<p><i>the most exposed and have the least protection. These highly delivery riders think that they did not have any social security coverage and aren't aware of all of their rights. They do not have any form of social safety net, be it life and health insurance, emergency savings, insurance against social setbacks or retirement savings.</i></p> <p>Researchers choose respondent 7 because this respondent answers the question more accurately and clearly. This respondent better understands the Awareness of social protection among gigeconomy workers by answering what is social protection and how related to food delivery riders and this respondent also answered all questions about this theme with more confidence. This respondent was very clever. Researchers gain a better grasp of this respondent's opinions and experiences through in-depth interviews.</p>
--	--	--

## **Finding Theme 2**

Table 4 below the result Findings of Theme 2

Table 4: Findings of Theme 1

No	Finding of Knowledge of social protection among gig economy workers	Interviewer's Transcription
1	Steps can you take to ensure you are enrolled in the social protection programs that meet your specific needs as a food rider?	<i>Respondent 1, a 25-34-year-old male food rider with a full-time job, earns a monthly income between RM 1000 and RM 1499 and has not received any social protection before. I think it's crucial to stay informed about the social protection programs available to us. The first step is to research and identify the programs that are most relevant to our needs, such as healthcare coverage, unemployment benefits, or retirement savings options. Once we've identified these programs, we should check if we meet the eligibility criteria and then apply accordingly. It's important to keep track of the application deadlines and document requirements to avoid any delays or issues in the application process. Lastly, we can seek assistance from relevant government agencies or NGOs if we face any challenges in accessing social protection programs.</i>

		<p>Researchers choose respondent 1 because this respondent answers the question more accurately and clearly. This respondent better understands the Knowledge of social protection among gig economyworkers by answering the Steps you can take to ensure you are enrolled in the social protection programs thatmeet your specific needs as a food rider in terms of viewpoint food rider, attitude, food rider’s real life circumstance, and personal experiences. Researchers gain a better grasp of this respondent’s opinions and experiences through in-depth interviews. Researchers are acquiring a deeper understanding of this respondent 1 and learning more from this respondent. The answers from this respondent to the research questions fulfil the research objectives with more information. This was thereason researchers chose respondent 1 to do theresearch findings.</p>
--	--	--

## LIMITATIONS AND RECOMMENDATIONS

During our research on social protection awareness among gig economy workers, we, as both researchers and students with packed schedules, managed to find time to pursue this study. However, we encountered limitations when interviewing eight food delivery respondents in Kota Bharu. One significant constraint was their limited time due to strict work regulations. These workers faced the risk of being banned if interviews exceeded a 15-minute limit while not actively taking or delivering orders, which greatly hindered our ability to gather information. To enhance awareness and knowledge on social protection for gig workers in Kota Bharu, it is recommended to develop targeted information campaigns. These campaigns should educate gig workers about their rights and the available social protection schemes, emphasizing benefits and eligibility criteria. This will enable gig workers to make informed decisions and access the support they are entitled to.

To enhance awareness and knowledge on social protection for gig workers in Kota Bharu, it is recommended to develop targeted information campaigns. These campaigns should educate gig workers about their rights and the available social protection schemes, emphasizing benefits and eligibility criteria. Additionally, the campaigns should provide practical guidance on how to navigate the application process and access the support they are entitled to. By doing so, gig workers will be empowered to make informed decisions and effectively utilize social protection programs tailored to their needs.

## CONCLUSION

In conclusion, this study aimed to assess the awareness and knowledge of social protection among gig economy workers in Kota Bharu. The findings of this study can serve as a valuable reference for future research on this topic. The results indicate that gig economy workers in Kota Bharu have a certain level of awareness and knowledge regarding social protection. However, they do not consider it a priority. It is hoped that the information presented in this study will be useful to researchers conducting further investigations in this area.

## REFERENCES

- Akter, M., Sadekin, M. N., & Patwary, A. K. (2020). An Empirical Study on Students' Satisfaction from Mawlana Bhashani Science & Technology University, Bangladesh. *Review of Economics and Development Studies*, 6(2), 363-379.
- Alom, S., Patwary, A. K., & Khan, M. M. H. (2019). Factors affecting the turnover intention of Bangladeshi migrants in the United Arab Emirates: An empirical study on the hotel industry. *International Journal of Innovation, Creativity and Change*, 8(3), 344-360.
- Amanda Yeo, Y. (2021, October 20). *The self-employed deserves better social protection*. EMIR Research. <https://www.emirresearch.com/the-self-employed-deserves-better-social-protection/>
- Awani, A. (2021, October 11). *The self-employed deserves better social protection*. astroawani.com. <https://www.astroawani.com/berita-malaysia/selfemployed-deserves-better-social-protection-324700>
- Azdee Amir. (2022, October 3). *Self-employed Malaysians urged to subscribe, contribute to Socso*. New Straits Times. <https://www.nst.com.my/news/nation/2022/10/836846/self-employed-malaysians-urged-subscribe-contribute-socso>
- Department of Statistic Malaysia. (2021). *Labour Force Statistic 2021*. <https://www.dosm.gov.my/v1/index.php?r=column/cthemByCat>
- Fengmin, Z., Baijun, W., Jiangtao, B., Li, L., & Patwary, A. K. (2022). Investigating revisit intention of medical tourists in China through nutritional knowledge, perceived medical quality, and trust in the physiologist: A recommendation on health tourism policy measures. *Frontiers in Public Health*, 10, 893497.
- Grossoehme, D. H. (2014). Overview of Qualitative Research. *Journal of Health Care Chaplaincy*, 20(3), 109–122. <https://doi.org/10.1080/08854726.2014.925660>
- Hazbar, A. M. H., Alem Mohammed, A., & Karim, A. K. A. (2019). An Empirical Study of Factors Influencing hotel customers' online booking Intention. *مجلة العلوم التربوية و الدراسات الإنسانية*, (5), 1-17.
- International Labour Organization. (2020, March 25). *Social protection responses to the Covid-19 crisis*. <https://www.social-protection.org/gimi/RessourcePDF.action?id=56001>
- Li, L., Ragavan, N. A., Patwary, A. K., & Baijun, W. (2022). Measuring patients' satisfaction toward health tourism in Malaysia through hospital environment, nutritional advice, and perceived value: A study on Chinese exchange students. *Frontiers in public health*, 10, 893439.
- Li, L., Wu, B., & Patwary, A. K. (2022). How marine tourism promote financial development in sustainable economy: new evidences from South Asia and implications to future tourism students. *Environmental Science and Pollution Research*, 29, 1155-1172.

- Li, L., Wu, B., & Patwary, A. K. (2022). The psychosocial factors affecting chinese Outbound Exchange and mobility students' academic performance during COVID-19. *Frontiers in psychology*, 13, 872516.
- Patwary, A. K., Roy, B., Hoque, R., & Khandakar, M. S. A. (2019). Process of developing a community based tourism and identifying its economic and social impacts: An Empirical study on Cox's Bazar, Bangladesh. *Pakistan Journal of Humanities and Social Sciences*, 7(1), 1-13.
- Peluang Pekerjaan Dalam Perkhidmatan P-Hailing (Penghantar Makanan) di Kalangan Bumiputera Semasa Pandemik Covid-19.* (2021). [Video]. TERAJU. <https://www.teraju.gov.my/videos/r4.mp4>
- Pritha Bhandari. (2020). *Data Collection | Definition, Methods & Examples*. Scribbr. <https://www.scribbr.com/methodology/data-collection/>
- Sumethokula, P., Patwary, A. K., Srinuanpanc, B., Srinuanpand, C., Suwandee, P., Thammathikul, A., & Phanong, W. (2020). The potential of new tour repackaging for creative tourism among entrepreneurs in Nakhon Si Thammarat. *International Journal of Innovation, Creativity and Change*, 13(10), 1752-1771.
- Wu, B., Liu, S., Wang, J., Tahir, S., & Patwary, A. K. (2021). Assessing the mechanism of energy efficiency and energy poverty alleviation based on environmental regulation policy measures. *Environmental Science and Pollution Research*, 28, 40858-40870.
- Wu, B., Zhai, B., Mu, H., Peng, X., Wang, C., & Patwary, A. K. (2021). Evaluating an economic application of renewable generated hydrogen: A way forward for green economic performance and policy measures. *Environmental Science and Pollution Research*, 1-15.

# **Awareness and Knowledge of Right To Disconnect After Work Among Lecturers In University Malaysia Kelantan (KOTA)**

*Mohamad Ramzi Bin Ab.Rahim*

*Muhammad Nizamuddin bin Shaharudin*

*Nur Syuhada Binti Ahmad*

*Nor Nabihah Binti Zakaria*

*Encik Muhammad Firdaus Bin Bidin\**

*Faculty of Hospitality, Tourism and Wellness, Universiti Malaysia Kelantan*

*Corresponding email:*

---

## **ABSTRACT**

*A job is a group of positions that have similar obligations or basic tasks. In job analysis activities, a job can be occupied by one person, or several people spread out in various places. The objective of this study is to study the awareness and knowledge of right to disconnect after work among lecturers in University Malaysia Kelantan (KOTA). This study examines the impact of disturbances on lecturers at University Malaysia Kelantan, focusing on the right to unplug after work and demand remuneration for labor after hours. Digital technology has enabled remote work, but it also leads to longer workdays. Governments must protect employees and address disconnect laws to ensure work-life balance. The research aims to promote a positive and useful solution for both employees and businesses, preventing recurring issues and promoting a more harmonious work environment.*

***Keywords: Awareness, Knowledge, Impact, Disconnect, Employees***

---

## **INTRODUCTION**

A job is a group of positions that have similar obligations or basic tasks. Under Section 60 (A) (9) of the Work Act 1955, "hours of work" are defined as the time during which an employee is at the disposal of the employer and is not free to dispose of his own time and movements. Businesses have been experimenting with Alternative Work Schedules (AWS) in an effort to increase employee engagement. Labor performed after regular business hours ends is considered overtime, but work completed on weekends and federal holidays is not. All employees have the right to disconnect after work, and for employees who are instructed to work outside working hours, they are entitled to demand payment. Employees can claim Overtime Pay together with allowances for carrying out official duties at office or any place directed after normal working hours or holidays.



## **SIGNIFICANCE OF THE STUDY**

This study is conducted to provide knowledge to academic research, educate the right awareness and knowledge to disconnect after work, and contribute to a better quality of life. It is expected to provide relief and knowledge about disturbances received after the end of working hours, as well as open the eyes of the community, especially the employer, to not disturb after the end of working hours. Unmanaged flexible working arrangements and the continued use of mobile communication technology have a measurable impact on workers' well-being.

## **LITERATURE REVIEW**

A literature review is an essential appraisal of the most recent body of information on a subject. It involves finding relevant literature, analyzing sources, identifying themes, controversies, and gaps, establishing the framework, and writing the literature review. This study will discuss the issues of awareness and the right to disconnect after work, as well as knowledge of awareness of the right to disconnect after work. It is important because it can give exposure and knowledge to the lecturers at University Malaysia Kelantan (Campus Kota) about the definition and accurate information about the right to disconnect after work.

## **Discussion of the issue**

Technology has improved employees' work lives by boosting productivity, gathering better records and data, and facilitating quick communication. However, it has also changed the where, when, and how frequently workers work. A 2015 study conducted in Britain provides "concrete evidence that happier employees are more productive in the workplace." Positive workplace morale fosters greater productivity, and there are both physical and psychological factors that impact employee morale. Research suggests that prospective applicants should consider work-life balance when applying for a job. The need for businesses to evaluate the expectation of workers to engage in after-hours work in a digital environment is highlighted by the ideals of Millennials and Gen Z employees.

Employees in this modern age are constantly linked to their jobs via their smartphones, laptops, tablets, and other electronic gadgets. Benoit Hamon, a former minister of education in France, claimed that "they stay linked by a sort of electronic leash, like a dog". These inquiries are being confronted by employers across all industries since they have emerged as modern workplace

concerns. The study on the right of employees not to be disturbed after working hours discusses the issue of excessive workload at home. Excessive workload occurs when employees exceed the limits they set for themselves in terms of hours worked or intensity of work.

This can be due to budget cuts, unfair treatment at work, a lack of role transparency, and a lack of managerial support. It also affects the morale of an employee, as 73% of respondents stated that work-life balance is more important than salary when assessing job opportunities. Among the detrimental impacts of an excessive workload are stress and burnout, as well as sleep disruption and acrimony in domestic personal relationships. In 2018, 76% of American employees reported that their personal relationships were impacted by work-related stress. Employees who work too hard and exceed their own capacity can be attacked by various diseases and problems either externally or internally, such as emotional stress and mental disorders.

Research on British civil servants in 2018 highlights a connection between work stress and metabolic syndrome, which increases the risk of diabetes, stroke, and heart disease. 94% of American employees in 2019 said that stress brought on by too much work was a problem. Overwork can result in burnout, which can aggravate existing conditions such as depression, anxiety, emotional tiredness, tension headaches or migraines, poor sleep, and unhealthy coping mechanisms like drug misuse. Emotional stress can affect life in terms of emotions, behavior, thinking ability, and so on. Employees who do not take care of their physical and mental health run the risk of contracting one of the many diseases that might develop.

## **METHODOLOGY**

### **Research Design**

Qualitative research is a collection of approaches used to gain a deeper understanding of people's perspectives, thoughts, attitudes, and real-life situations. It is used to gain a deeper understanding of people's perspectives, thoughts, attitudes, and real-life situations, as well as to produce theoretical approaches to those personal experiences. Qualitative research was used to explain the phenomena being investigated using respondents' and 23 researcher's phrases. Qualitative research provides extensive characterizations of respondents' thoughts, ideas, and personal

experiences, as well as an analysis of the relevance of their activities. It also enables the researcher to look into respondents' inner experiences and how societal and societal judgements are made.

Phenomenological studies look at personal beliefs and the explanations they give, known as "life experience," to define the meaning that each individual acquires from their interactions. Phenomenology assists researchers in developing a fundamental knowledge of how people act.

### **Data Collection**

This text discusses the methods used to collect primary and secondary data. Primary data is specific and provides more detailed information and is current, while secondary data is obtained from books, newspapers, research journals, and observation. The main negative is that the data was acquired for another reason, making it possible that it won't be trustworthy. In a personal or face-to-face interview, a standard arranged question is utilised to ensure that nearly all participants were asked the exact same range of questions in the same order. Research studies known as surveys use participant interviews to gather data.

For this particular study, 8 lecturers underwent in-depth interviews to understand awareness and knowledge of right to disconnect after work among lecturers in University Malaysia Kelantan (Kota). An in-depth interview was the methodology employed in this study.

### **Sampling**

The data for this study was collected in the Universiti Malaysia Kelantan (Kota) at Pengkalan Chepa, Kota Bharu, Kelantan. The main purpose of this initiative is to provide knowledge and awareness about the rights that need to be known after the end of working hours. The sample size was limited to 8 lecturers from the Universiti Malaysia Kelantan (Kota) for the data collection method, which was an in-depth interview conducted by the face-to-face. Sampling methods should be as rigorous as possible to keep errors and biases minimal and to increase maximum representation. A non-probability sampling technique was applied and a judgemental or purposive sample approach was used. Purposive sampling is a sampling technique related to the researcher's criteria, and since only Universiti Malaysia Kelantan (Kota) lecturers participated in the respondent's study, the researcher needs to go to the campus and meet the lecturers to collect data with this sampling technique.

### **Data Analysis**

Thematic analysis is a key step in qualitative research, as it compiles and summarises common observations and perceptions of the subject, as well as justifications and textual comments to back them up. It involves reading transcripts several times, taking notes, recording the researcher's initial hypothesis, creating the initial code, and finding topics. Themes are patterns that highlight an important or fascinating aspect of data or study topics, and are used to explore those themes and draw conclusions regarding issues. It is a common error to use the primary query as the topic of the interview, as this indicates that the information has been organised and summarised rather than analysed.

## **FINDINGS**

### **Analysis of Theme 1**

Table 1 below shows Analysis of Theme 1

Table 1: Analysis of Theme 1

Research Question	Respondent	Theme
-------------------	------------	-------

<p>1. Are you aware that employees can take legal action if they are forced to work even after working hours have ended?</p>	<p><b>R1:</b> In my opinion, not all lecturers are aware. They will feel safer. It needs to be spread so that people know. Not necessarily because there is a law. They will be positive because misbehaviour can be avoided.</p> <p><b>R2:</b> Less clear with awareness. The law can protect workers in this context if they are persecuted. For example, if the company forces employees to work but they are not paid and they work during non-working hours, You can give information, but not in a backstabbing manner that tarnishes the image of any party. University Malaysia Kelantan (UMK) has its own advisor, and he will ensure the matter does not go off track. Negative because it causes one party to be wrong. Whether the positive effect is good depends on the individual.</p> <p><b>R3:</b> Action can be taken against the employer. Very safe to protect employees. I agree when it comes to mental well-being. Some lecturers don't really care because they think the work can be completed as soon as possible. Can't be at will. Need authentic evidence to the detriment of health and well-being. Each party needs to be tolerant. Cooperate with each other. There must be rules to protect the rights of employees and employers.</p> <p><b>R4:</b> Can take legal action when forced to become pressured. Legal action should be taken. We need to tell others so there is awareness. It is definitely safe because there is an association</p>	<p>1. Awareness to disconnect after work</p>
--	--	--

	<p>like Labor. Employees know they are safe. I agree because they have no right to be bullied and forced to cause stress at work. Can't because there needs to be tolerance. Manipulating the right to disagree. There is a positive in everything that happens.</p> <p><b>R5:</b> There is no flexible time. There is no more when working as a lecturer. Can't take things for granted. It is good that there is awareness so that there is no oppression.</p> <p><b>R6:</b> They are aware but is it applicable to professionals such as lecturers? It should be, yes. That's the purpose of the law created to protect oppressed workers. Of course. Creating and spreading awareness is everyone's responsibility</p> <p><b>R7:</b> Yes, I am aware of that. Yes, they will feel safer. Yes, I agree, and in addition, the employer should spread awareness to all employees. It should follow the law. It surely has a positive effect on both employees and employers.</p> <p><b>R8:</b> Yes, I am aware. Absolutely. Of course. Sharing something like this will create a better working environment for the staff. Depending on what you mean by arbitrarily. The majority of staff rarely take the opportunity to use their legal rights, even though they actually need them. Again, it depends on the situation.</p>	
--	--	--

## Analysis of Theme 2

Table 2 below shows Analysis of Theme 2

Table 2: Analysis of Theme 2

Research Question	Respondent	Theme
<p>1. In your opinion, should a person be instructed to continue working after working hours or on weekdays</p> <p>And WhatsApp as one medium to work?</p>	<p>R1: Depending on the situation and the type of work if the work is given time to complete, then it can be postponed to the next week. WhatsApp facilitates communication, acts as a reminder, and much more. No additional fees are required. There are no interruptions. It is not mandatory to contact Used to it. Mandatory for the employer to answer.</p> <p>R2 : On weekends. If possible, the staff tries to avoid it. Had to direct other workers outside of working hours. Excellent tools. Media that makes it easy and also for supporting documents. It can be a folder to save documents. Important for work. Lecturers do not have flexible hours for overtime work. WhatsApp makes work easier, and there is no time limit. Delaying a task if it involves something important The choice is in one's own hands not to be disturbed. Can't be blamed for being out of work hours.</p> <p>R3 : It is inappropriate to be instructed outside of working hours. But it depends on the situation. There are pros and cons. Can be contacted at any time. The lecturer has no extra points. Flexible hours and no timeframe You need to limit time and need space for yourself, depending on the situation and how you manage time. Employers need to give time to their own employees.</p>	<p>2. Knowledge to disconnect after work</p>

R4 : You have to look at the situation to see if there is no problem with that. Not something formal but important. There is no need to pay. As long as there is a period of work, then it is necessary to work. The date of delivery of the work should be emphasised. No problem.

R5 : It is possible if there is an additional payment. WhatsApp is very good and helpful. Charged because the lecturer does not have overtime. Disturbing if outside working hours

R6 : There is no need because work-life balance is more important. WhatsApp is not a problem to use as a medium or a tool for work because it is easier, but the time to use it should be limited after work hours. If it is to be counted, I think it is appropriate because the lecturer's job involves a lot of cognitive things, and sometimes until the night is still facing work. Perhaps a task record system can be created for the time count and recorded payment.

R7 : No need. It helps us a lot, but we can't rely on it 100%. Yes, you must be paid if working overtime. No, because it depends on the workplace.

R8 : need .But if the instructions come with valid documents, then they have to be obeyed. Just follow the technology as it evolves. Similar to how people communicate with letters, now we communicate through WhatsApp. Of course, unless it was something that deal with the



	flexibility of how those 8 hours operated, additional payment might not be needed. Yes absolutely. Depending on the situation But most of the situations did not actually need the employer to disturb after office hours.	
--	--	--

## Findings of Theme 1

Table 3 below shows the result Findings of Theme 1

No	Awareness to disconnect after work	Interview's Transcription
1	Awareness to disconnect after work among lecturers at University Malaysia Kelantan(Kota)	<p>Respondent 4, 38 years old, a married male lecturer. Can take legal action when forced to become pressured. Legal action should be taken. We need to tell others so there is awareness. It is definitely safe because there is an association like labor. Employees know they are safe. I agree because they have no right to be bullied and forced to cause stress at work. Can't because there needs to be tolerance. Manipulating the right to disagree. There is a positive in everything that happens.</p> <p>Researchers chose respondent 4 because this respondent answered the question more accurately and clearly. This respondent knows well a lot about awareness to disconnect after work among lecturers at University Malaysia Kelantan (Kota) and this respondent also answered all questions about this theme with more confidence. This respondent was very clever. Researchers gain a better grasp of this</p>

	respondent's opinions and experiences through in-depth interviews.
--	--

## Findings of Theme 2

Table 4 below shows the result Finding of Theme 2

No	Knowledge of right to disconnect after work	Interview's Transcription
1	Knowledge of right to disconnect after work among lecturers at University Malaysia Kelantan(Kota)	<p>Respondent 8, 30 years old, a female lecturer No need .But if the instructions come with valid documents, then they have to be obeyed. Just follow the technology as it evolves. Similar to how people communicate with letters, now we communicate through WhatsApp. Of course, unless it was something that dealt with the flexibility of how those 8 hours operated, additional payment might not be needed. Yes absolutely. Depending on the situation But most of the situations did not actually need the employer to disturb after office hours.</p> <p>Researchers chose respondent 8 because this respondent answered the question more accurately and clearly. This respondent better understands the knowledge of right to disconnect after work. This respondent also answered all questions about this theme with more confidence. This respondent was very brilliant. Researchers gain a better grasp of this respondent's opinions and experiences through in-depth interviews. Researchers are acquiring a deeper understanding of this respondent 8 and learning more from this</p>

		<p>respondent. The answers from this respondent to the research questions fulfil the research objectives with more information. This was the reason researchers choose this respondent 8 to do the research findings.</p>
--	--	---

## LIMITATION AND RECOMMENDATION

This research study faced several limitations, including time constraints, lack of previous studies on qualitative methods in awareness and knowledge of the right to disconnect after work among lecturers at University Malaysia Kelantan (Kota), and overload of tasks. Researchers recommended seeking permission from the university to conduct in-depth interviews with respondents, providing more qualitative research and secondary data sources, and using Google Forms and social media platforms to distribute study questions.

To expand the research beyond University Malaysia Kelantan (Kota), researchers should expand the study to include all university professors and obtain contact information for all professors who wish to participate. This will help eliminate misunderstandings and bias and generate better study outcomes.

Employees can propose that their employers better limit working hours, set specified boundaries, and create practices that respect work-life balance, especially if their case is built on the need to preserve health. It will be interesting to see if multinational corporations headquartered in states where there are laws protecting the right to disconnect will implement similar rules locally.

Lecturer work-life balance must be studied in the academic setting in terms of spatial and temporal flexibility, employment practices, and employee habits. Researchers across all career stages recognize the need to enhance work-life balance. Departments and institutes must help improve research practices for academics at all levels of their careers. By respecting limits and giving individuals greater authority over their own work schedule, PIs and mentors can build healthier workplaces in their laboratories.

## CONCLUSION

This study aimed to analyze the awareness and knowledge of the right to disconnect after work among lecturers at University Malaysia Kelantan (Kota). Eight respondents from various faculties

were analyzed. The researchers concluded that the university can provide proper awareness and knowledge about the right to disconnect after work. They also suggested recommendations for improving awareness and knowledge among lecturers. The study's findings are accepted and will be helpful for future researchers, providing valuable sources and ideas.

## REFERENCES

- Akter, M., Sadekin, M. N., & Patwary, A. K. (2020). An Empirical Study on Students' Satisfaction from Mawlana Bhashani Science & Technology University, Bangladesh. *Review of Economics and Development Studies*, 6(2), 363-379.
- Alom, S., Patwary, A. K., & Khan, M. M. H. (2019). Factors affecting the turnover intention of Bangladeshi migrants in the United Arab Emirates: An empirical study on the hotel industry. *International Journal of Innovation, Creativity and Change*, 8(3), 344-360.
- Bahana Kerja melebihi masa berita harian*. (n.d.). Retrieved January 8, 2023, from <https://www.bharian.com.my/wanita/sihat/2020/02/651832/bahana-kerja-melebihi-masa>
- Basu, T. (2015, August 19). *Working overtime linked to increased risks of stroke, heart disease*. Time. Retrieved January 8, 2023, from <https://time.com/4003902/working-long-hours-stroke-heart-disease/#:~:text=Those%20who%20work%20such%20long,to%2040%2Dhour%20work%20week>
- Bettina Burgess, Hina Ghaus (2022, March 23). *2022 EMPLOYMENT, LABOUR & EQUALITIES LAW WEBINAR SERIES RIGHT TO DISCONNECT*. Retrieved from <https://gowlingwlg.com/getmedia/7110f6f9-06aa-4259-a6a6-6b89b7eaba34/Gowling-WLG-Right-to-disconnect-2-March-23.pdf.xml>
- Elliott, T. (2022, February 14). *Working Overtime: The effects of long working hours on productivity*. Official Teamly Blog - Official Teamly Blog - Your Project Management Resource. Retrieved January 8, 2023, from <https://www.teamly.com/blog/working-overtime/>
- Fengmin, Z., Baijun, W., Jiangtao, B., Li, L., & Patwary, A. K. (2022). Investigating revisit intention of medical tourists in China through nutritional knowledge, perceived medical quality, and trust in the physiologist: A recommendation on health tourism policy measures. *Frontiers in Public Health*, 10, 893497.
- GS;, K. E. S. B. T. (n.d.). *Working overtime is associated with anxiety and depression: The Hordaland Health Study*. *Journal of occupational and environmental medicine*. Retrieved January 8, 2023, from <https://pubmed.ncbi.nlm.nih.gov/18545093/>
- Hazbar, A. M. H., Alem Mohammed, A., & Karim, A. K. A. (2019). An Empirical Study of Factors Influencing hotel customers' online booking Intention. *مجلة العلوم التربوية و الدراسات الإنسانية*, (5), 1-17.
- Li, L., Ragavan, N. A., Patwary, A. K., & Baijun, W. (2022). Measuring patients' satisfaction toward health tourism in Malaysia through hospital environment, nutritional advice, and perceived value: A study on Chinese exchange students. *Frontiers in public health*, 10, 893439.

- Li, L., Wu, B., & Patwary, A. K. (2022). How marine tourism promote financial development in sustainable economy: new evidences from South Asia and implications to future tourism students. *Environmental Science and Pollution Research*, 29, 1155-1172.
- Li, L., Wu, B., & Patwary, A. K. (2022). The psychosocial factors affecting chinese Outbound Exchange and mobility students' academic performance during COVID-19. *Frontiers in psychology*, 13, 872516.
- Muhammad Yusry (2022, October 12) *Mental illness a big issue in Malaysia, says expert* Retrieved from <https://www.thesundaily.my/local/mental-illness-a-big-issue-in-malaysiasays-expert-NL9973285>
- OnLabor. (2022, March 30). *The right to disconnect: Emerging issues and ways to overcome them* ♦ onlabor. OnLabor. Retrieved January 8, 2023, from <https://onlabor.org/the-right-to-disconnect-emerging-issues-and-ways-to-overcome-them/>
- Patwary, A. K., Roy, B., Hoque, R., & Khandakar, M. S. A. (2019). Process of developing a community based tourism and identifying its economic and social impacts: An Empirical study on Cox's Bazar, Bangladesh. *Pakistan Journal of Humanities and Social Sciences*, 7(1), 1-13.
- Phil Jones Nick Bano (2021, August) *THE RIGHT TO DISCONNECT* . Retrieved from <https://autonomy.work/wp-content/uploads/2021/08/the-right-to-disconnect-AutonomyFINAL.pdf>
- Picincu, A. (2021, November 20). *The effects of a heavy workload on employees*. Bizfluent. Retrieved January 8, 2023, from <https://bizfluent.com/info-8178431-effects-heavy-workload-employees.html>
- Right to disconnect policy requirement - Gowling WLG*. (n.d.). Retrieved January 8, 2023, from <https://gowlingwlg.com/getmedia/7110f6f9-06aa-4259-a6a6-6b89b7eaba34/Gowling-WLG-Right-to-disconnect-2-March-23.pdf.xml>
- Scribd. (n.d.). *Pengenalan Hak-Hak Pekerja PDF*. Scribd. Retrieved January 8, 2023, from [https://www.scribd.com/document/388124530/Pengenalan-hak-hak-pekerja-PDF-pdf#:~:text=Hak%20ialah%20suatu%20yang%20dimiliki,atau%20patut%20diberi%20kepada%20orangramai.%20Abidin,%20N.%20Z.%20\(2008\).%20Kerjaya%20sebagai%20pensyarah.%20PTS%20Professional.](https://www.scribd.com/document/388124530/Pengenalan-hak-hak-pekerja-PDF-pdf#:~:text=Hak%20ialah%20suatu%20yang%20dimiliki,atau%20patut%20diberi%20kepada%20orangramai.%20Abidin,%20N.%20Z.%20(2008).%20Kerjaya%20sebagai%20pensyarah.%20PTS%20Professional.)
- Sumethokula, P., Patwary, A. K., Srinuanpanc, B., Srinuanpand, C., Suwandee, P., Thammathikul, A., & Phanong, W. (2020). The potential of new tour repackaging for creative tourism among entrepreneurs in Nakhon Si Thammarat. *International Journal of Innovation, Creativity and Change*, 13(10), 1752-1771.
- The right to disconnect - autonomy.work*. (n.d.). Retrieved January 8, 2023, from <https://autonomy.work/wp-content/uploads/2021/08/the-right-to-disconnect-AutonomyFINAL.pdf>
- Working overtime can lead to anxiety, depression | EHS Today*. (n.d.). Retrieved January 8, 2023, from <https://www.ehstoday.com/safety/article/21906197/working-overtime-can-lead-to-anxiety-depression>
- Wu, B., Liu, S., Wang, J., Tahir, S., & Patwary, A. K. (2021). Assessing the mechanism of energy efficiency and energy poverty alleviation based on environmental regulation policy measures. *Environmental Science and Pollution Research*, 28, 40858-40870.

- Wu, B., Zhai, B., Mu, H., Peng, X., Wang, C., & Patwary, A. K. (2021). Evaluating an economic application of renewable generated hydrogen: A way forward for green economic performance and policy measures. *Environmental Science and Pollution Research*, 1-15.
- Yusry, M. (n.d.). *Mental illness a big issue in Malaysia, says expert*. [www.thesundaily.my](https://www.thesundaily.my). Retrieved January 8, 2023, from <https://www.thesundaily.my/local/mental-illness-a-big-issue-in-malaysia-says-expert-NL9973285>

# Awareness and Knowledge of Academic Burnout Among Students in University Malaysia Kelantan Kampus Kota: A Qualitative Study

*Nurfarahim binti Mohd Zuki, Aiman Insyirah binti Kharudin, Ain Sabrina binti Azmi, Malini A/P Baloo & Muhammad Firdaus bin Bidin*

*Faculty of Hospitality, Tourism and Wellness, Universiti Malaysia Kelantan*

[mfirdaus.b@umk.edu.my](mailto:mfirdaus.b@umk.edu.my)

---

## ABSTRACT

Academic burnout entails the tiredness and disengagement students endure due to long-term exposure to specified academic expectations. Academic burnout has various negative consequences, including poor academic performance and mental health. The rate of Malaysian students suffering from mental health problems doubled in less than a decade, from 10% in 2011 to 20% in 2016. This study examined the awareness and knowledge of academic burnout among the University Malaysia Kelantan Kampus Kota students. This study also proposes recommendations and suggestions for preventing student stress and burnout. This study conducted an in-depth interview where print-out questions were given to the respondents. This study used 'purposive sampling' where only University Malaysia Kelantan Kampus Kota students participated.

**Keywords: Awareness, Knowledge, Academic Burnout**

---

## INTRODUCTION

Burnout as a psychological notion has recently been understood and one of the pioneers in the study of burnout was Herbert Freudenberger. He found that a group of volunteers he worked with were becoming emotionally spent and losing motivation over time. Students may occasionally experience pressure from academic achievement, university life, and the transition experienced between adolescence and adulthood. These persistent pressures on students, particularly in Malaysia, result from the mindset of the students, who believe that a high cumulative grade point average (CGPA) in their studies is necessary to land a better career in the future. Due to the rigours of university life, this perspective leads to mental and emotional pressure, producing academic burnout in university students.

Burnout is not a new illness, although it has only been recognised as a condition since Maslach identified it in her book in 1982 (Church, 2019). Although burnout is not a disorder, according to the Diagnostic and Statistical Manual of Mental Disorders (APA, 2010), it is a 'life management' problem, per the International Statistical Classification of Diseases and Related Health Problems (WHO, 2019). Burnout frequently causes significant disruption due to people's emotional and physical exhaustion due to external and internal stresses and poor coping and adaptive capacities (Bullock et al., 2017). Burnout is also influenced by one's environment and workload (Friganović et al., 2021).

Since the COVID-19 pandemic, burnout has worsened. Lockdowns have forced the closure of schools and institutions globally, making students to have significant burnout levels during the quarantine due to stress, depression and anxiety. According to meta-analyses, 9% to 54% of students worldwide reported psychological suffering (Długosz & Liszka, 2021). The incidence of mild to profound depression, anxiety and stress in a survey of Malaysian university

students is 37.2%, 63.0%, and 23.7% for depression, anxiety, and stress, respectively (Shamsuddin et al., 2018).

To overcome stress and academic burnout, it is vital to recognise academic burnout among students at Malaysian higher education level institutes. Early diagnosis and prevention of burnout among university students are critical from a public health standpoint. This is critical for educational progress, future job growth, and the nation because today's young are tomorrow's leaders (Shamsuddin et al., 2018). Rising suicide rates have brought burnout and mental health issues into the limelight, raising awareness of burnout among Malaysians. Nevertheless, Malaysian students rarely examine burnout, indicating a need for exploration.

Therefore, this study investigates the awareness and knowledge of academic burnout among Universiti Malaysia Kelantan Kampus Kota students. The objectives of this study are

1. To examine the awareness of academic burnout among Universiti Malaysia Kelantan Kampus Kota students
2. To analyse the knowledge of academic burnout among Universiti Malaysia Kelantan Kampus Kota students
3. To propose recommendations and suggestions for preventing stress among the Universiti Malaysia Kelantan Kampus Kota students.

## **SIGNIFICANCE OF THE STUDY**

A study's importance determines its relevance. It speaks about the study's impact on a research field and its contribution(s). The student's mental health level, the effects of stress on students, and the best way to prevent stress among the Universiti Malaysia Kelantan Kampus Kota students. The findings of this study will help prevent students from stress. Stress shields a person from physical harm and temporarily boosts performance to increase the likelihood of survival. Notably diminished are sleep and appetite, while anxiety is elevated.

## **LITERATURE REVIEW**

### **Awareness of Burnout**

Generally, "awareness" indicates "knowledgeable being mindful; cognizant, educated, vigilant." The condition or capacity to notice, feel, or be mindful of events, objects, or sensory patterns is known as awareness (K. Abdul Ghafor, 2012). Being aware entails knowing, realising, or showing interest in something and knowing it is significant. Knowledge of something is awareness.

### *Health*

It has been discovered that students majoring in healthcare are more likely to experience sadness, anxiety, tension, and insomnia. The COVID-19 pandemic seems to have worsened people's mental health problems. The absence of safety and health monitoring for the students themselves, which harms patient security, consistency of care, costs of the healthcare system, and workflow, is one reason why burnout in healthcare workers is receiving attention. Providing fresh approaches to treating burnout conditions is crucial to identify potential remedies (Leo et al., 2009).

### *Cleanliness*

According to the proverb "Cleanliness is next to Godliness," cleanliness is a positive cultural trait supporting other goals like health and beauty (Berg, 2003). Students' discomfort is impacted by



cleanliness. A student will experience burnout if the school environment is not pristine. The cleanliness of oneself, other students, and the school will affect one's mental health. Other students' stress levels will be impacted by students who do not maintain good personal hygiene. This will raise the high cognitive level.

### *Pollution*

Air pollution was shown in several experimental and observational research that air pollution exposure was linked to behavioural problems and mental diseases. Additionally, some research discovered links between air pollution and depression, as well as mental emergencies. The better air quality will benefit our ecosystem, health, and development. Environmental and individualised factors can affect mental stress according to ecological models.

### **Knowledge of Burnout**

In particular, the findings of this study added to the body of knowledge on how young adults, especially students with burnout, can experience it in various contexts. It is also likely that people in certain professions are more aware of emotional health issues and a great way to spot the warning symptoms of imminent burnout, which could explain why burnout is most prevalent in these sectors. Most research on personal factors has examined demographic elements like age, gender, etc. Personality, social support, and beliefs are additional unique characteristics that have drawn some attention (Maslach & Schaufeli, 1996).

### **Academic Burnout**

Academic burnout developed from the phrase "job burnout" in the workplace. Burnout among university students is defined as weariness caused by academic expectations (emotional exhaustion), having a negative attitude and lack of interest in academic duties (cynicism), and a sense of incompetence as a student (inefficacy) (Charkhabi et al., 2013). Academic burnout is a serious issue and has a detrimental impact on students. It has also been connected with an increased risk of suicide ideation among students (Oloidi et al., 2022), lower academic achievement, low self-efficacy, perceived course load, and lower coping effectiveness (Portoghese et al., 2018).

Students in a burnout state often feel exhausted and adopt a cynical, withdrawn motivation towards their studies. Academic burnout in students results from exhaustion due to demands and academic obligations, negative emotions, lack of interest in work and experiencing incompetency. Risk factors for burnout may include unrealistic or perfectionistic expectations at work or study, heavy workload, family environment (Amelia, 2022), conflicts in the university, feeling undervalued, poor self-esteem, and poor coping skills in stress management. Academic burnout takes time to arise, and it is difficult to combat once it has occurred. Thus, the sooner one recognises and addresses the signs of stress, the higher the chance that an individual has of avoiding burnout.

## Research Framework

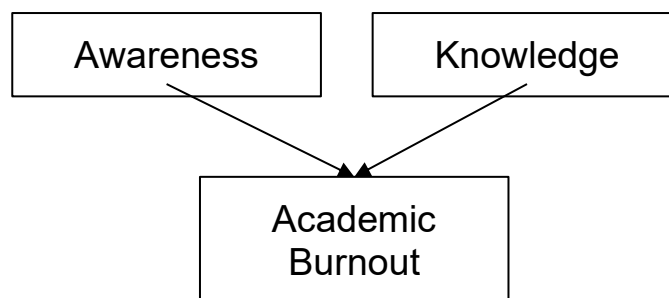

Diagram 1: Conceptual Framework

## METHODOLOGY

### Research Design

This research design seeks to determine how well-aware and knowledgeable University Malaysia Kelantan Kampus Kota students are about academic burnout and make recommendations for preventing it. Qualitative research is more successful, using a small yet focused sample size and a case study approach. Data is collected through focus groups, interviews, and indirect procedures.

### Data Collection

The data collection method is divided into three parts which are primary data, secondary data and in-depth interviews. Primary data was all about collecting data through Google Forms-based and print-out-based questionnaires that were distributed physically and electronically. Secondary data were collected through books, newspapers, and research articles as sources of information and direction to boost this study. Lastly, an in-depth interview with four randomly selected University students was done in an in-depth online interview due to the first wave of post-flood.

### Sampling

Sampling is picking a group from which the researchers will gather the data for their study. The probability and non-probability sampling methods are the two available sampling techniques. A non-probability sampling technique has been applied in this study. In addition, a judgemental or purposive sample approach has been used in this study. When choosing participants or public members to participate in the study, the researchers use a selection technique known as "purposeful sampling," which involves using their best judgement.

### Data Analysis

As for the data analysis, thematic analysis has been used throughout this study. The thematic analysis works to analyse the awareness and knowledge of academic burnout and also the suggestions and recommendations to prevent the stress among the University Malaysia Kelantan Kampus Kota students by using four respondents among the students to conduct the online survey which is a questionnaire and another four respondents had conducted an in-depth interview. Eight respondents were shown in an online survey and in-depth interview for this research.

## FINDINGS

## Analysis of Theme 1

Table 1 below shows the result Analysis of Theme 1

Table 1: Analysis of Theme 1

Research Question	Respondent	Theme
Malaysian students rarely examine burnout, although it is getting recognition. In your opinion, why is burnout rarely being talked about among Malaysian students?	<p><b>R1:</b> Burnout is frequently perceived as typical stress that students must deal with.</p> <p><b>R2:</b> In my opinion, we don't normalise discussing burnout or depression among students since the answer is typically the same when we are stressed or burnout because we have a lot of duties.</p> <p><b>R3:</b> This is because students conceal their emotions and their stress so that others do not know.</p> <p><b>R4:</b> This is because students have the impression that they prefer to conceal all of their troubles with professors, friends, and family.</p> <p><b>R5:</b> Burnout is rarely discussed among Malaysian students because Malaysian students seem unconcerned about it.</p> <p><b>R6:</b> Burnout is a relatively new notion in Malaysia, and many individuals are likely unaware of it. Burnout is a medical disorder that was just recently acknowledged. As a result, many individuals may need to be made aware of what burnout is, how to recognise it, and how to deal with it.</p> <p><b>R7:</b> It is because students are preparing for high-stakes tests or writing influential academic papers.</p> <p><b>R8:</b> Students nowadays are subjected to several examinations and tasks.</p>	Burnout being left out among Malaysian students

## Analysis of Theme 2

Table 2 below shows the result Analysis of Theme 2

Table 2: Analysis of Theme 2

Research Question	Respondent	Theme
-------------------	------------	-------

<p>What makes you struggle to cope with university activities and study? Did you often feel it at the beginning or end of the semester?</p>	<p><b>R1:</b> I struggle or experience stress after the semester due to the composition of the final assignment and other increasingly numerous assignments.</p> <p><b>R2:</b> I don't find balancing university activities with studies complex because I have a routine.</p> <p><b>R3:</b> It takes time to understand a topic and issue. As a result, the conclusion of the semester is felt even more keenly because the exam is approaching.</p> <p><b>R4:</b> I'll notice it near the end of the semester since I usually finish my work, study, and take notes at the last minute. To be more specific, I am a 'last-minute' person.</p> <p><b>R5:</b> The tasks offered by many teachers make it difficult for me to cope with university activities and academics. It's most noticeable near the conclusion of the semester.</p> <p><b>R6:</b> It happens regularly near the end of the semester since so many things happen simultaneously as I prepare for the final exam.</p> <p><b>R7:</b> Nothing. No.</p> <p><b>R8:</b> Group projects are the most challenging part, typically at the end of the semester.</p>	<p>Students struggle to cope with university life.</p>
---	--	--

### Analysis of Theme 3

Table 3 below shows the result Analysis of Theme 3

Table 3: Analysis of Theme 3

Research Question	Respondent	Theme
<p>Environment plays a vital role in our daily life. How can an unsupportive environment, whether at</p>	<p><b>R1:</b> The environment causes academic burnout to occur. Students are the great hope of parents, lecturers, and the desire to obtain excellent academic achievements.</p>	<p>Impact of the unsupportive environment on academic burnout</p>

<p>university or home, cause academic burnout?</p>	<p><b>R2:</b> Burnout may occur at both institutions and the home environment for me, but it is always conquered by ourselves and our thinking.</p> <p><b>R3:</b> The setting is the same at the university and at home. Friendship can be handy in university. Parents and siblings assist at home as well.</p> <p><b>R4:</b> The unsupportive environment can cause stress to students.</p> <p><b>R5:</b> A filthy setting, such as having a lot of waste, does not offer students a comfortable studying atmosphere.</p> <p><b>R6:</b> My home environment contributes to my academic weariness since I am required to study and perform homework at home. In contrast, I simply have to concentrate on my studies at university.</p> <p><b>R7:</b> Stress, initiate and trapped.</p> <p><b>R8:</b> Depressed, irritated and exhausted.</p>	
--	--	--

#### Analysis of Theme 4

Table 4 below shows the results Analysis of Theme 4

Table 4: Analysis of Theme 4

Research Question	Respondent	Theme
<p>From your perspective, how important is it to overcome academic burnout? What can the university do to help students overcome it?</p>	<p><b>R1:</b> A student must conquer the challenge. The institution may address the issue by creating programmes and motivational camps to educate students about the significance of self-motivation and applying religious and moral principles.</p> <p><b>R2:</b> Every semester, universities should offer a counselling session to students so that they may hear what the problem is. However, the counsellor must be the one who can protect the student's privacy.</p> <p><b>R3:</b> Give the students time and assist the students who face difficulties.</p>	<p>Steps to overcome academic burnout</p>

	<p><b>R4:</b> Counselling should be provided to students by the university, and it would be more beneficial if the university took the students on a stroll outside.</p> <p><b>R5:</b> In my view, it is important to overcome the problem of academic fatigue so that students can focus on their studies.</p> <p><b>R6:</b> It is essential to keep students from becoming anxious. As much as possible, the university avoids putting too much pressure on students and offers counselling to those who require it.</p> <p><b>R7:</b> Very important.</p> <p><b>R8:</b> It is pretty significant. Professors and students should create positive interactions at the university level.</p>	
--	---	--

### Findings of Theme 1

Table 5 below shows the results Findings of Theme 1

Table 5: Analysis of Theme 1

No	Findings of Burnout being left out	Interview's Transcription
1	Burnout being left out among Malaysian students	<p><i>Respondent 6, between 21 to 23 years old, a Malay female from faculty JDS 1st year. Burnout is a relatively new concept in Malaysia; many people may need to know it. Burnout was only recently recognised as a medical condition. So, many people may need to learn what burnout is and how to identify and address it.</i></p> <p>Researchers chose respondent six because the respondent answered well and very clearly. As we can see, the respondent has expressed her thoughts about why burnout is being left out among Malaysian students. So, from her ideas, many people don't know the term burnout until now.</p>

### Findings of Theme 2

Table 6 below shows the results Findings of Theme 2

Table 6: Analysis of Theme 2

No	Findings of Students' Struggle to Cope	Interview's Transcription
1	The struggle to cope with university life among students	<p><i>Respondent 5, between 21 to 23 years old, is a Malay female from faculty FHPK 2nd year. What makes me struggle to cope with university activities and studies is the assignments given by many lecturers. I often feel it at the end of the semester.</i></p> <p>Researchers chose respondent five because this respondent answered well and very clearly. As we can see, the respondent understood well and expressed her struggle during her studies. Nowadays, it can't be denied that students have to face many challenges and obstacles during their study period. At the same time, it becomes one of the reasons why students always face academic burnout.</p>

### Findings of Theme 3

Table 7 below shows the results Findings of Theme 3

Table 7: Analysis of Theme 3

No	Findings of Impact of Unsupportive Environment	Interview's Transcription
1	Impact of the unsupportive environment on academic burnout among Students	<p><i>Respondent 6, between 21 to 23 years old, a Malay female from faculty JDS 1st year. I believe that my home environment contributes to my academic burnout weariness since I am required to study at home. In contrast, I simply have to concentrate on my studies at university.</i></p> <p>Researchers chose respondent six because this respondent answered well and very clearly. As we can see, it has shown that this respondent has spoken out her opinion about the impact of the unsupportive environment on academic burnout among students. Based on this respondent's opinion, we can conclude that the unsupportive climate will affect the students, especially in their studies.</p>

### Findings of Theme 4

Table 8 below shows the results Findings of Theme 4

Table 8: Analysis of Theme 4

No	Findings of Steps Overcoming Academic Burnout	Interview's Transcription
1	Steps to overcome academic burnout among Students	<p><i>Respondent 1, between 21 to 23 years old, a Malay female from faculty FKP 2nd year. A student institution must address the issue by creating programmes and motivational camps to educate students about the significance of self-motivation and the application of religious and moral principles.</i></p> <p>Researchers chose respondent one because this respondent answered well and very clearly. As we can see, this respondent understands the question well and gives her opinion about what the institution should do to overcome academic burnout among the students.</p>

## DISCUSSION AND RECOMMENDATION

As for the discussion part, there are four different limitations in this study which are the first limitation is the researcher needs help conducting face-to-face, in-depth interview sessions with respondents due to the first wave of post-flood. The second limitation is the need for previous studies regarding academic burnout among students, especially in qualitative research. The third limitation is the researcher's limitations in analysing due to the limited time and sample size. The fourth limitation is some of the respondents' responses make it difficult for the researchers to assess them.

Furthermore, as for the recommendation part, there are five different recommendations in this study which are the first recommendation is the researcher can conduct the indirect meeting due to the flood. The second recommendation is that universities or other higher education institutions give more examples of qualitative research to make it easier for students to find references, especially for specific themes. The third recommendation is that future researchers utilise other platforms, such as Google Forms and social media, to distribute study questions to potential responders and gather data. Instagram, Twitter, and Facebook are among the preferred social media networks. The fourth recommendation is the students should manage and spend their time correctly. The fifth recommendation is the researcher advises pupils to be more conscious of their surroundings and current events.

## CONCLUSION

Ultimately, this study aimed to shed light on the problem of academic burnout among students at Universiti Malaysia Kelantan Kampus Kota. Researchers concluded that there needed to be more knowledge concerning academic burnout among students at Universiti Malaysia Kelantan Kampus Kota. Whatever the case, raising awareness and comprehension of the danger of academic burnout is crucial.



## REFERENCES

- Akter, M., Sadekin, M. N., & Patwary, A. K. (2020). An Empirical Study on Students' Satisfaction from Mawlana Bhashani Science & Technology University, Bangladesh. *Review of Economics and Development Studies*, 6(2), 363-379.
- Alom, S., Patwary, A. K., & Khan, M. M. H. (2019). Factors affecting the turnover intention of Bangladeshi migrants in the United Arab Emirates: An empirical study on the hotel industry. *International Journal of Innovation, Creativity and Change*, 8(3), 344-360.
- Amelia, R. N. (2022). Literature Review of Academic Burnout. *American Research Journal of Humanities & Social Science (ARJHSS)*, 05(02), 06-13.
- APA. (2010). *Diagnostic and statistical manual of mental disorders, text revision (DSM-IV-TR®)*.
- Bullock, G., Kraft, L., Amsden, K., Gore, W., Prengle, B., Wimsatt, J., Ledbetter, L., Covington, K., & Goode, A. (2017). The Prevalence and Effect of Burnout on Graduate Healthcare Students. *Canadian Medical Education Journal*, 8(3), 90-108.
- Charkhabi, M., Azizi Abarghuei, M., & Hayati, D. (2013). The association of academic burnout with self-efficacy and quality of learning experience among Iranian students. *Springerplus*, 2(1), 1-5.
- Church, J. A. (2019). Was I prepared for burnout?: A qualitative study about burnout among nurses.
- Długosz, P., & Liszka, D. (2021). The Relationship between Mental Health, Educational Burnout and Strategies for Coping with Stress among Students: A Cross-Sectional Study of Poland. *International Journal of Environmental Research and Public Health*, 18(20), 10827.
- Fengmin, Z., Baijun, W., Jiangtao, B., Li, L., & Patwary, A. K. (2022). Investigating revisit intention of medical tourists in China through nutritional knowledge, perceived medical quality, and trust in the physiologist: A recommendation on health tourism policy measures. *Frontiers in Public Health*, 10, 893497.
- Friganović, A., Kurtović, B., & Selič, P. (2021). A cross-sectional multicentre qualitative study exploring attitudes and burnout knowledge in intensive care nurses with burnout. *Slovenian Journal of Public Health*, 60(1), 46-54.
- Hazbar, A. M. H., Alem Mohammed, A., & Karim, A. K. A. (2019). An Empirical Study of Factors Influencing hotel customers' online booking Intention. *مجلة العلوم التربوية و الدراسات الإنسانية*, 5(5), 1-17.
- Li, L., Ragavan, N. A., Patwary, A. K., & Baijun, W. (2022). Measuring patients' satisfaction toward health tourism in Malaysia through hospital environment, nutritional advice, and perceived value: A study on Chinese exchange students. *Frontiers in public health*, 10, 893439.
- Li, L., Wu, B., & Patwary, A. K. (2022). How marine tourism promote financial development in sustainable economy: new evidences from South Asia and implications to future tourism students. *Environmental Science and Pollution Research*, 29, 1155-1172.
- Li, L., Wu, B., & Patwary, A. K. (2022). The psychosocial factors affecting chinese Outbound Exchange and mobility students' academic performance during COVID-19. *Frontiers in psychology*, 13, 872516.
- Mortier, P., Cuijpers, P., Kiekens, G., Auerbach, R., Demyttenaere, K., Green, J., Kessler, R., Nock, M., & Bruffaerts, R. (2018). The prevalence of suicidal thoughts and behaviours among college students: a meta-analysis. *Psychological medicine*, 48(4), 554-565.
- Naluri. (2022, September 30). *Taking Southeast Asia's Largest Mental Health Data Set to the Next Stage*. Naluri. <https://www.naluri.life/article/taking-southeast-asias-largest-mental-health-data-set-to-the-next-stage>

- Oloidi, F. J., Sewagegn, A. A., Amanambu, O. V., Umeano, B. C., & Ilechukwu, L. C. (2022). Academic burnout among undergraduate history students: Effect of an intervention. *Medicine*, *101*(7), e28886-e28886.
- Patwary, A. K., Roy, B., Hoque, R., & Khandakar, M. S. A. (2019). Process of developing a community based tourism and identifying its economic and social impacts: An Empirical study on Cox's Bazar, Bangladesh. *Pakistan Journal of Humanities and Social Sciences*, *7*(1), 1-13.
- Portoghese, I., Leiter, M. P., Maslach, C., Galletta, M., Porru, F., D'Aloja, E., Finco, G., & Campagna, M. (2018). Measuring burnout among university students: factorial validity, invariance, and latent profiles of the Italian version of the Maslach Burnout Inventory Student Survey (MBI-SS). *Frontiers in psychology*, *9*, 2105.
- Shamsuddin, K., Fadzil, F., Ismail, W. S. W., Shah, S. A., Omar, K., Muhammad, N. A., Jaffar, A., Ismail, A., & Mahadevan, R. (2018). Correlates of depression, anxiety and stress among Malaysian university students. *Asian journal of psychiatry*, *6*(4), 318-323. <https://doi.org/10.1016/j.ajp.2013.01.014>
- Sumethokula, P., Patwary, A. K., Srinuanpanc, B., Srinuanpand, C., Suwandee, P., Thammathikul, A., & Phanong, W. (2020). The potential of new tour repackaging for creative tourism among entrepreneurs in Nakhon Si Thammarat. *International Journal of Innovation, Creativity and Change*, *13*(10), 1752-1771.
- WHO. (2019). *ICD-11 for Mortality and Morbidity Statistics*. ICD-11 for Mortality and Morbidity Statistics. <https://icd.who.int/browse11/l-m/en>
- Wu, B., Liu, S., Wang, J., Tahir, S., & Patwary, A. K. (2021). Assessing the mechanism of energy efficiency and energy poverty alleviation based on environmental regulation policy measures. *Environmental Science and Pollution Research*, *28*, 40858-40870.
- Wu, B., Zhai, B., Mu, H., Peng, X., Wang, C., & Patwary, A. K. (2021). Evaluating an economic application of renewable generated hydrogen: A way forward for green economic performance and policy measures. *Environmental Science and Pollution Research*, 1-15.
- Yeo, A. (2021, July 2). Mental health is critical and needs to be addressed. *The Sun Daily*. <https://www.thesundaily.my/local/mental-health-is-critical-and-needs-to-be-addressed-IE8024831>

# Political Awareness And Knowledge Amongst Student In University Malaysia Kelantan

Muhammad Zuhaili Bin Abdul Jaabar, Muhammad Naqiudin Husna Bin Md Liza, Muhammad Afiq Aliff Bin Zolkofle, Muhammad Syahmi Afkar Bin Mohamad Fauzi & Muhammad Firdaus bin Bidin.

Faculty of Hospitality Tourism and Wellness, University Malaysia Kelantan

Corresponding email: [mfirdaus.b@umk.edu.my](mailto:mfirdaus.b@umk.edu.my)

## ABSTRACT

*It is crucial to highlight to children the importance of political awareness and information. The high level of student engagement in the General Election did not provide promising results, as the data shows that a decreasing number of students turned out to vote in the 2019 and 2022 elections. This essay makes an attempt to evaluate data acquired from Universiti Malaysia Kelantan in order to ascertain whether the democratic education offered by the Institute of Public Higher Education is indeed capable of teaching students to comprehend the democratic system. This study used an in-depth interview method with 20 FHPK students that were enrolled at Universiti Malaysia Kelantan. The information for this study was compiled after the 15th General Election voting day.*

**Keyword: Politics, Knowledge, Awareness, Students, Government**

## INTRODUCTION

One of the most basic needs in life is political awareness since it helps societies evolve and lays the ground for the civil society organisations to be active within such communities, both of which take constant work. Instead of speeches or writing, well-researched, rational, and scientific programmes must be developed with the aim of bringing about a shift in the level of consciousness. In fact, it is very necessary to explore how to spread these reforming ideas to such a large population, how to evaluate their impacts, and how to manage and direct them. In reality, the only means by which this can be accomplished is through specialised organisations in charge of managing the different facets of life. The Sun, 25 October 2017

The youth group is one of the important groups in the political survival of a country. This is because this youth group is the group with the largest number of voters on the fence and is decisive for the victory of a political party in Malaysia (Nur Ellyyanis and Junaidi, 2020 ).The university is such a cutting-edge organisation that it contributes significantly to providing its students with political awareness in terms of information, behaviours, traditions, and abilities that guarantee the individual's social and political role.

According to Alsati and Al-Ghanem (2017), educational institutions have the greatest impact on people's political awareness and practice through their educational approaches and activities, through their teachers' lectures and conferences, as well as through their educational courses and curricula.

## SIGNIFICANCE OF STUDY

### UNIVERSITY STUDENT

In the life of societies, political action is of tremendous importance. They are incredibly invested in each other and every aspect of their everyday lives, therefore that explains why. It is a procedure and a technique for a group to decide things, according to the definition of politics (Al Slihat, 2014). Political conduct may be found in business, academic, religious, and other organisations despite the fact that it is most frequently used to refer to the government. Political science analyses how power is used and available, including the capacity to impose one's will on others. Political conduct is the subject of this research. The whole of a person's perceptions, knowledge, and assessments make up their awareness. In actuality, consciousness evolves and expands along with the individual's existence, and as a result, is a product of the numerous cultural influences on the individual. In other words, a person's political awareness will be higher the better their political culture is (Abonu, Ogunlade,&Yunusa, 2013).

## LITERATURE REVIEW

## **KNOWLEDGE**

Knowledge are the things that individual get from many sources including reading, observation or with their experience. Knowledge also measure to rate their intelligence and memorize about something they had learning. Knowledge also are the facts, information and skill through experience by practical or theoretical. From dictionary Cambridge meaning of knowledge are understanding of or information about a subject by get the experience or study, either known by one person or by people generally.(Cambridge dictionary,2022). In this research, we need to know how the knowledge of citizen Malaysia about politic in generally or complex.

## **AWARENESS**

To create a democratic society that is based on responsibility, openness, and effective governance, political awareness is very essential. Thus, engagement from the populace is essential to the survival and further growth of every democracy. Being critical of the government's acts, inactions, programmes, and policies helps to perpetuate democracy since politically savvy citizens do so. Politically engaged individuals ought to be able to hold their government and other public officials responsible for how the nation's affairs are run, according to Ahmad et al. (2015). Three factors have been identified as influencing political awareness: the degree of exposure to political information, the mental capacity to store and organise political knowledge, and the motivation to learn and comprehend the political news. In other words, being politically aware entails having access to political information, engaging in political activity, and using the media primarily for political material that piques one's curiosity about politics and current events. (Kuotsu, 2016).

## **POLITICS**

The low rates of young people participating in formal and informal politics, such as voting in elections and party politics, have received a lot of attention in the literature (Robertson, 2009). The diminishing rates of young people's political involvement in recent years have raised worries and become a global phenomenon, according to Blais and Rubenson (2013, cited in Castillo et al. 2015). Currently, young people are the least likely to participate in political party activities and voting procedures. Not every university student is engaged in politics, either on or off campus. Some of them are just concerned in collecting mementos. Consider the T-shirts, shirts, lanyards, caps, and other items that various political party groups with a presence on campus have made available. Others, however, would rather be involved in actual politics, which external political groups provide as a chance to sharpen students' political abilities and put those talents to the test. A democratic group made up of students from universities and other higher education institutions is represented in the Student Union or Student Representative Council, a form of campus management (SRC).

## **METHODOLOGY**

### **RESEARCH DESIGN**

Research configuration guarantees the data required, from whom, and how it will respond to the examination question. Research configuration affected the level at which causal cases about the impact of intercession can be made (Jalil, 2013).

According to Kothari (2004), quantitative and qualitative research methods are commonly used in research. In this research, a qualitative study was used to find out the pattern of political awareness and knowledge among students at Universiti Malaysia Kelantan FHPK (Kota Campus). Qualitative research is multi-method in nature and takes an analytical, phenomenological approach to its topic. This suggests that qualitative researchers investigate phenomena in their natural environment, aiming to understand or comprehend events from the perspective of definitions given to them by individuals. Case studies, personal observations, introspection, personal histories, interviews, observations, histories, interpretations, and visual texts are examples of observational data used in qualitative research to describe normal and difficult situations and values in human life (Patrik Aspers & Ugo Corte, 2019). ).

### **DATA COLLECTION**

Data collection is one of the most important steps in any research project. Data collection is a difficult task that necessitates meticulous planning, hard work, tolerance, tenacity, and other qualities in order to be completed successfully (Marie Volpe, 2018). Data collection is one of the most important steps in any research project. Data collection is a difficult task that necessitates meticulous planning, hard work, tolerance, tenacity, and other qualities in order to be completed successfully. Some of the seeds of that revolution were found in approaches to data collection that used a combination of methods. This book focuses on recent advancements in mixed method strategies for collecting scientific data (WG Axinn,2006) . The process of acquiring, processing, and evaluating research data using well-established, validated procedures that incorporate both primary and secondary data is sometimes referred to as data collection (Syed Muhammad Sajjad Kabir, 2016).

## **SAMPLING**

A sample is a small group of people chosen from a larger population so that statistical inferences may be made about them and population characteristics can be calculated. Sampling is the method of choosing the group from whom data will be gathered for the study. Using samples, one may draw conclusions about populations. Samples make data collection easier since they are practical, affordable, manageable, and simple. The two types of sampling that may be employed in research are probability sampling and non-probability sampling. With probability sampling, any group within the community has an equal chance of being selected as a representative sample. Non-probability sampling is a sampling strategy where the person who will be picked as a sample from the population is unknown.

## **DATA ANALYSIS**

Data analysis is the act of finding and arranging interview transcripts, observation notes, and other non-textual materials obtained by the researchers to better understand the phenomena in qualitative research. The act of gathering, evaluating, and analysing data to obtain insights that improve decision-making is known as data analysis. There are a range of approaches and strategies for conducting an analysis depending on the sector and the purpose of the research (Calzon, 2021). Researchers have used thematic analysis to produce data for this study. Thematic analysis is used in this study's data analysis to pinpoint and evaluate the degree of political awareness and knowledge among students at Universiti Malaysia Kelantan's (Kota Campus) through in-depth interviews. The researcher uses in-depth interviews to gather data; specifically, the researcher uses Google Meet to conduct online interviews with open-ended questions for each respondent. In-depth interviewers typically begin by asking fundamental questions before inviting subjects to speak candidly about the issue. Another type allows for the potential of a semi-structured interview, in which the interviewer is given the choice to go more into one of the themes while still using a set of prepared questions. In-depth interviews offer a lot of data as well as chances to ask follow-up questions, elicit more data, corroborate initial replies, and make connections between various topics. Additionally, it fosters a welcoming atmosphere where people may feel more at ease starting conversations (Andre Queiros et al., 2017). As a result, 15 undergraduate students participated in this study and performed in-depth interviews. Thematic analysis was utilised to analyse the data for this study.

### **Empirical paper**

#### **Finding**

#### **Analysis theme 1**

**Table 1 below shows the result Analysis of Theme 1**

**Table 1: Analysis of Theme 1**

<b>Research question</b>	<b>Respondent</b>	<b>Theme</b>
What motivated you to participated in this year's general election	R1: because it has become a responsibility to vote when you reach the age of 21	To examine the awareness of politic among student in University Malaysia Kelantan

	<p>R2: because it is beyond the level of responsibility for someone to participate in this general election.</p> <p>R3: for having reached the eligibility age limit to carry out the responsibility of voting</p> <p>R4: The right to vote is a responsibility that must be fulfilled by Malaysian citizens</p> <p>R5: have reached the appropriate age limit to vote and the influence of social media that many display the responsibility to vote for the future of the country which is one to vote</p> <p>R6: a high sense of responsibility to be an adult in making a decision to find a leader</p> <p>R7 : the first year to vote beyond the requirement to vote. Besides, that year is the year that can vote after five year. Therefore, I am quite excited to participated in the general election this year.</p> <p>R8: the spirit of nationalism is the most powerful incentive for becoming involved in the general election because it engenders a strong sense of duty to guarantee that country administrative apparatus is governed by the proper people.</p> <p>R9: to carry out responsibilities and individual right as Malaysia.</p> <p>R10 : carry out responsibilities as Malaysia</p> <p>R11: to choose a leader who is responsible for the work given</p> <p>R12: age has passed the age limit for voting</p>	
--	--	--

**Analysis of Theme 2**

**Table 2 below shows the result Analysis of Theme 2**

**Table 2: Analysis of Theme 2**

Research question	Respondent	Theme
-------------------	------------	-------

<p>how do you stay informed about politic events and issue</p>	<p>R1: know about political issue through social media</p> <p>R2: be informed about political events or issues through social media and newspaper clippings that always publish the issues that occur</p> <p>R3: through television programs such as news and social media networks that share a lot of political events and issues during the election period</p> <p>R4: by using authentic and trusted channels such as awani and named but every news I get I will keep and it is for my own use in choosing the political party I will vote for. the news is also not spread because it is for my own use.</p> <p>R5: aware of politics from social media platforms such as instagram, facebook and the most famous application tiktok</p> <p>R6: political issues are brought up and debated by student and the information that is debated is not only in front of the eyes but many express it on social media causing student to be more exposed to hotly debated issues.</p> <p>R7: get info through social media that is always updated</p> <p>R8: social media is the most effective channel for disseminating news. In addition to the availability of internet news, electronic media makes it easier for us to obtain information and stay up to date on current events.</p> <p>R9: through socializing and interacting with politicians and the development of current issues on social media</p> <p>R10: informed through mass media such as tv and smartphones</p> <p>R11: through various ways such as watching the news on television, reading newspaper and so on.</p> <p>R12: informed about events and politics issue through social media and newspaper</p>	<p>to study the knowledge of political awareness among student in University Malaysia Kelantan</p>
--	--	--

	clipping that always publish the issue that occur.	
--	--	--

## Findings of Theme 1

Table 3 below shows the result Findings of Theme 1

**Table 3: Findings of Theme 1**

NO.	Finding of awareness of politic	Interview's Transcription
1.	<b>Awareness of politic among student</b>	<p><i>Respondent 6, 23 years old, a Malay girl from FHPK 3 years student, yes I aware about politics because a high sense of responsibility to be an adult making decision find leader. Young voters are not familiar or member of political party. Because they fed up has seen that there been a power in struggle in previous leadership. I also not feeling that describe, not to obsessed with politics and common knowledge of politics will never run of issue. Important student participated issue or debate in this country. Lately current politic environment undesirable since the leader cannot agree on how difficult confronting the country and crisis.</i></p> <p>Researchers choose respondent 6 because the respondent answer the question more accurately and clearly. This respondent know well a lot about awareness of politic among student. This respondent was very clear to answer the question and the answer are different along other respondent.</p>

## Findings of Theme 2

Table 4 below shows the result Findings of Theme 2

**Table 4: Findings of Theme 2**

No.	Finding knowledge in politic	Interview's Transcription
1.	<b>Knwoledge of politic among student</b>	<p><i>Respondent 3 , 22 years old , an Malay female from faculty FHPK 3rd year. Through social media, newspaper articles, and digital platforms, I kept up with political news and topics. Every nation need a smart and just leader, therefore voters must make their decisions based on the numerous qualities that person must possess. The largest difficulty arises when a party makes it difficult for voters to select a government because it demonstrates a lack of political cohesion. When the winning candidate is unpopular with the electorate and the election outcome is not totally representative of the electorate, it will have an impact on the nation. According to me, the newly elected government's top objective is ensuring that every state, race, and religion in the nation is treated equally.</i></p> <p>Researcher chose respondent 3 because this respondent answered the question the question accurate and clearly. This respondent understand the question and better than other respondent as well.</p>



		This respondent also had a knowledge of politics as well. This respondent was very brilliant to answer the question without make other person fell guilty.
--	--	--

## LIMITATION AND RECOMMENDATION

Limitations are happened in any study as the challenge to conclude an excellent research process and it is the same in this research. Throughout the process of doing research, it is of the utmost importance for the researchers to work toward reducing the variety and scope of constraints to the greatest extent possible. Firstly, the lack of previous study on qualitative methods in political awareness and knowledge among students made it difficult for researchers to get new information. This was also a contributing factor in the difficulty of the research. There is another book with a like title, but unlike that one, it does not focus on students or the area surrounding University Malaysia Kelantan. Aside from that, there were not enough previous studies done in the area where the research was conducted. The name of this study does not yet involve conducting research in the area surrounding the Universiti Malaysia Kelantan (Campus Kota) campus. In order to conduct superior research in the future, researchers will either need to uncover new initiatives or make use of the research recommendations presented here.

Also, there was not enough of the intended population to conduct in-depth interviews with. Because of time constraints, the researcher was unable to conduct in-depth interviews with all of the students enrolled in programmes ranging from their first to their fourth years of study at the Universiti Malaysia Kelantan (Kota Campus). They are not interested in participating in this interview session since they do not have sufficient information and are not aware of the political issues that are being discussed. As a result of this, the researcher had a tough time interacting and communicating with the students so that they could more effectively take part in this interview session. In addition to this, one of the difficulties that the researchers have encountered while carrying out their research is a shortage of time. As a result of the researchers and respondents being busy with their own studies, the coursework for each subject, and their online learning on a tight schedule, the time available for in-depth interview sessions was limited. This is due to the fact that researchers have a hard time getting respondents' time for the purpose of conducting interviews. Because of this, finishing this research paper will take a significant amount of time.

### Conclusion

It is recommended that all universities publish multiple qualitative research and samples of qualitative research reports on fast-food consumption among Malaysian students as a reference in the future. Every single university Many secondary data sources, such as research material in textbooks, journal articles, conferences, seminars, and dissertations, both published and unpublished, must be available in the library in order to gain knowledge for qualitative research. Other than Universiti Malaysia Kelantan (Campus Kota), the research should be increased. Because this study focused on samples collected at Universiti Malaysia Kelantan (Campus Kota), data obtained from other Malaysian sites may be better or different.

### References

- “Gerakan Politik Mahasiswa Di Malaysia - UUM Repository.” Gerakan Politik Mahasiswa Di Malaysia - UUM Repository, [repo.uum.edu.my/id/eprint/2418](http://repo.uum.edu.my/id/eprint/2418).
- “International Journal of Information Movement – IJIM.” International Journal of Information Movement – IJIM, 31 July 2022, [www.ijim.in](http://www.ijim.in).
- “Lebih Sejuta Belia Usia 18 Hingga 20 Tahun Mengundi Kali Pertama – PORTAL SINARHARIAN.” Lebih Sejuta Belia Usia 18 Hingga 20 Tahun Mengundi Kali Pertama

- “Mahasiswa Matang Berpolitik Dengan Program Pendidikan Undi18.” *MalaysiaGazette*, 5 Oct. 2022, [malaysiagazette.com/2022/10/05/mahasiswa-matang-berpolitik-dengan-program-  
pendidikan-undi18](https://malaysiagazette.com/2022/10/05/mahasiswa-matang-berpolitik-dengan-program-pendidikan-undi18)
- “Peranan Mahasiswa Di PRU15.” *zulkiflihasan.com*, 27 Oct. 2022,  
[www.zulkiflihasan.com/2022/10/27/peranan-mahasiswa-di-pru15](http://www.zulkiflihasan.com/2022/10/27/peranan-mahasiswa-di-pru15)
- “Politik: Mahasiswa Harus Ambil Tahu.” *HarakahDaily*, 11 Oct. 2022,  
[harakahdaily.net/index.php/2022/10/11/politik-mahasiswa-harus-ambil-tahu](http://harakahdaily.net/index.php/2022/10/11/politik-mahasiswa-harus-ambil-tahu)
- “Tahap Pengetahuan Dan Impak Kegiatan Politik Kampus Kepada Kehidupan Mahasiswa Era Malaysia Baharu | Malaysian Journal of Student Advancement @ Jurnal Personalia Pelajar.” *Malaysian Journal of Student Advancement @ Jurnal Personalia Pelajar | HEP-UKM*, 31 Dec. 2019, [www.ukm.my/personalia/publication/tahap-pengetahuan-dan-  
impak-kegiatan-politik-kampus-kepada-kehidupan-mahasiswa-era-malaysia-baharu](http://www.ukm.my/personalia/publication/tahap-pengetahuan-dan-impak-kegiatan-politik-kampus-kepada-kehidupan-mahasiswa-era-malaysia-baharu)
- Akter, M., Sadekin, M. N., & Patwary, A. K. (2020). An Empirical Study on Students’ Satisfaction from Mawlana Bhashani Science & Technology University, Bangladesh. *Review of Economics and Development Studies*, 6(2), 363-379.
- Alom, S., Patwary, A. K., & Khan, M. M. H. (2019). Factors affecting the turnover intention of Bangladeshi migrants in the United Arab Emirates: An empirical study on the hotel industry. *International Journal of Innovation, Creativity and Change*, 8(3), 344-360.
- Badaru, K. A., and E. O. Adu. “University Students’ Media Use and Political Participation in South Africa | South African Journal of Higher Education.” *University Students’ Media Use and Political Participation in South Africa | South African Journal of Higher Education*, 2 Apr. 2020, [www.journals.ac.za/index.php/sajhe/article/view/3382](http://www.journals.ac.za/index.php/sajhe/article/view/3382).
- Dibetle, Monako. “Student Politics Is Dead.” *The Mail & Guardian*, 14 June 2007, [mg.co.za/article/2007-06-14-student-politics-is-dead](http://mg.co.za/article/2007-06-14-student-politics-is-dead).
- Fengmin, Z., Baijun, W., Jiangtao, B., Li, L., & Patwary, A. K. (2022). Investigating revisit intention of medical tourists in China through nutritional knowledge, perceived medical quality, and trust in the physiologist: A recommendation on health tourism policy measures. *Frontiers in Public Health*, 10, 893497.
- Hazbar, A. M. H., Alem Mohammed, A., & Karim, A. K. A. (2019). An Empirical Study of Factors Influencing hotel customers' online booking Intention. *مجلة العلوم التربوية و الدراسات الإنسانية*, (5), 1-17.
- Li, L., Ragavan, N. A., Patwary, A. K., & Baijun, W. (2022). Measuring patients' satisfaction toward health tourism in Malaysia through hospital environment, nutritional advice, and perceived value: A study on Chinese exchange students. *Frontiers in public health*, 10, 893439.
- Li, L., Wu, B., & Patwary, A. K. (2022). How marine tourism promote financial development in sustainable economy: new evidences from South Asia and implications to future tourism students. *Environmental Science and Pollution Research*, 29, 1155-1172.
- Li, L., Wu, B., & Patwary, A. K. (2022). The psychosocial factors affecting chinese Outbound Exchange and mobility students’ academic performance during COVID-19. *Frontiers in psychology*, 13, 872516.
- Meor Shakri, Meor Harman. “Undi 18 Bukan Main-main.” *Utusan Malaysia*, 7 Jan. 2023, [www.utusan.com.my/commentary/undi-18-bukan-main-main](http://www.utusan.com.my/commentary/undi-18-bukan-main-main)

- Patwary, A. K., Roy, B., Hoque, R., & Khandakar, M. S. A. (2019). Process of developing a community based tourism and identifying its economic and social impacts: An Empirical study on Cox's Bazar, Bangladesh. *Pakistan Journal of Humanities and Social Sciences*, 7(1), 1-13.
- Rani, J. Jhansi. "Shodhganga@INFLIBNET: Political Awareness and Political Participation of Women in Guntur District." Shodhganga@INFLIBNET: Political Awareness and Political Participation of Women in Guntur District, 1 Jan. 2001, shodhganga.inflibnet.ac.in/handle/10603/71367.
- Sumethokula, P., Patwary, A. K., Srinuanpanc, B., Srinuanpand, C., Suwandee, P., Thammathikul, A., & Phanong, W. (2020). The potential of new tour repackaging for creative tourism among entrepreneurs in Nakhon Si Thammarat. *International Journal of Innovation, Creativity and Change*, 13(10), 1752-1771.
- Wu, B., Liu, S., Wang, J., Tahir, S., & Patwary, A. K. (2021). Assessing the mechanism of energy efficiency and energy poverty alleviation based on environmental regulation policy measures. *Environmental Science and Pollution Research*, 28, 40858-40870.
- Wu, B., Zhai, B., Mu, H., Peng, X., Wang, C., & Patwary, A. K. (2021). Evaluating an economic application of renewable generated hydrogen: A way forward for green economic performance and policy measures. *Environmental Science and Pollution Research*, 1-15.

# Factors Influencing Green Restaurant Revisit Intention Among Consumers in Malaysia

Nurul Nasuha Ashyak Ahmad, Nur Alia Atirah Che Aznan,  
Zuridayu Madius, Erina Yasmin Mohd Rosli \*Nurul Hafizah Mohd  
Yasin

Faculty of Hospitality, Tourism, and Wellness, Universiti Malaysia Kelantan  
Corresponding email: [Hafizah.my@umk.edu.my](mailto:Hafizah.my@umk.edu.my)

## ABSTRACT

*The analysis revealed that performance green consumerism, perceived value, perceived quality, and product price positively influence consumers' revisit intention in the green restaurant. The findings revealed that perceived value had the biggest effect on diners' inclination to return to green restaurants. Other theories may be used to direct future research into the elements that motivate a green restaurant is environmentally friendly in all food production and sales areas. There needs to be more existing research on the demand for green practices within the food service sector from the consumers' perspectives in Malaysia. Therefore, this study aims to determine the factors influencing consumers' intention to revisit green restaurants. This study employed a correlational cross-sectional survey through purposive sampling to collect information concerning the intention to revisit green restaurants. The proposed model is an extension of UTAUT and was empirically tested using data obtained from an online survey of revisit intention (n=250). 250 data were analyzed using Statistical Package for social science (SPSS) version 28.0. ate patrons to return to green eateries.*

**Keywords: Green Consumerism, Perceived value, Perceived Quality, Product Price, Revisit Intention**

## INTRODUCTION

A green restaurant, known as a sustainable or eco-friendly restaurant, is an establishment that incorporates environmentally friendly practices and principles into its operations and overall ethos. The term "green" in this context refers to the focus on reducing the environmental impact of the restaurant's activities, promoting sustainability, and supporting the well-being of the planet. The main objective of green restaurant is to examine the factors that influence green restaurant to revisit intention among consumers in Malaysia.

Looking at the Malaysian restaurant industry, green practices are still in their early stages, with little consumer interest. This can be seen in the fact that very few restaurants in Malaysia Restaurant's green practices. However, restaurant operators in Malaysia will adopt green practices if there is increased awareness among entrepreneurs and the public, complete government guidance and support, and expert monitoring of green practice operations (Langgat, 2019.)

Therefore, this study aims to investigate the factors influencing green restaurant revisit intention among consumers in Malaysia. The findings of this study helped the researchers to comprehend how customers and green eateries interact. There were five goals for this study:

- 1: To determine the influence between green consumerism and revisit the intention of green restaurants in Malaysia
- 2: To determine the influence between green perceived value and revisit the intention of green restaurants in Malaysia.
- 3: To determine the influence between green perceived quality and revisit the intention of green restaurants in Malaysia.
- 4: To determine the influence between product price and revisit intention of green restaurants in Malaysia.

## **SIGNIFICANCE OF THE STUDY**

### ***Future Research***

The relevance of this study becomes a guide and source for future research on revisiting the intention of green restaurants among consumers in Malaysia. Other researchers can also improve this study and rearrange the old study to be used as a new one and get a better idea about the scope of this study's investigation based on the result that will be obtained.

### ***Policy***

The findings of this research will provide various information on the existing policy of green food to take appropriate action. This study can give ideas to the related agency to implement various related programs such as the implementation of go green program, green procurement implementation seminars, Worldwide Green Energy & Environmentally Sound Products Exhibition & Conference Malaysia (IGEM), and the 3R program's implementation (reduce, reuse, recycle). In daily life, this program can help users get information related to green restaurants in Malaysia.

### ***Consumer***

The findings will directly benefit consumers in Malaysia in enhancing awareness about green restaurants by enhancing their green consumerism, the green perceived value, green perceived quality, and product price, which can enhance revisit intention toward green restaurants in Malaysia.

### ***Restaurant Entrepreneur***

The significance of this study benefits restaurant operators because the government serves as an alternative platform for educating Malaysian consumers about the value of environmentally friendly restaurants for them to support green restaurant operators in Malaysia by enforcing environmental legislation and regulations (Kasim et al., 2015). Consequently, environmental issues may be reduced to aid in environmental sustainability, resulting in a natural environment for the community, and more customers may reconsider Malaysian green restaurants.

## LITERATURE REVIEW

### ***Relationship Between Green Consumerism And Revisit Intention***

*Customers become more worried about the environmental impact of commercial activities that are becoming popular vocal supporters of responsible individual behavior (Warburg et al., 2021). Green consumerism refers to customer awareness of the climate change crisis, as well as consumer initiatives or movements aimed at protecting the surroundings and reducing consumption's negative impact (Rizomyliotis et al., 2021). According to previous literature, many studies have been carried out to look into what influences green restaurant revisit intention among Malaysian consumers (Atzori et al., 2018). Consumers are becoming environmentally conscious even more probable to practise continual consumerism (Kim & Park, 2020). Consumers develop favorable attitudes toward green restaurants because of environmental concerns. Positive attitudes refer to the underlying theory (Perugini et al., 2001), which can lead to consumer revisit intention (Yadav., 2017). Previous research has found that the consumer purchase decisions are influenced by a variety of factors, including perceived effectiveness of eco-friendly behaviour, everyday green consumption habits, environmental knowledge, and a company's green reputation. (Han, 2021). However, little study has been conducted on green consumerism.*

### ***Relationship Between Green Perceived Value And Revisit Intention***

A consumer's overall assessment of the worth of a certain good, service, or market offering is known as perceived value (Patterson., 1997). Green restaurant revisits intent is significantly predicted by consumer perceived value (Teng & Wu, 2019). Based on their environmental sustainability demands, expectations, and aspirations, consumers evaluate the total value of a market product, which are referred to like perceived value of green (Juliana et al., 2020). According to existing research, destination loyalty is predicted by perceived value, and perceived value is derived from product or brand experience (Teng & Wu, 2019). In addition, grasp customer intention requires a grasp of perceived value (Jiang & Hong, 2021). Several studies have been conducted to investigate customers' behavioural intentions in relation to green marketing efforts such as environmental, green innovation, and restaurant green programmes (Nicolau et al., 2020). According to extensive study, perceived worth and characteristic intention are positively correlated that influences prospective purchasing intention by increasing trust in the purchased item, and optimism influences consumers' future intentions (Chen., 2012).

### ***Relationship Between Green Perceived Quality And Revisit Intention***

Consumers' overall assessment of a company's differences or dominance is perceived quality (Alamsyah et al., 2021). Most restaurants base their satisfaction level on perceived quality (Agnihotri & Chaturvedi, 2018). The phrase "customer general assessment of a product's overall environmental quality or superiority" is used to describe products' green perceived quality by Wasaya et al. (2021), and it is a distinguishing feature that frequently influences consumers' opinions of that product's greenness (Alams et al., 2021). The success of the green quality's perception is supported by extensive study. Customers respond positively to it, and it also makes them more likely to make purchases (Wasaya et al., 2021). Customers who are environmentally conscious are more inclined to frequent eateries that are considered as having a high level of green quality (Ahn & Kwon, 2020). In addition, perceived quality is a well-known advertising concept, with research

indicating a positive relationship with customer loyalty. As a result, customer intent to return should be predicted by green perceived quality. It is reasonable to expect a stronger link between green values and revisit intentions when the perceived level of greenness is high.

### ***Relationship Between Product Price And Revisit Intention***

According to Zeithaml (1988), "price is an element that is compromised when it comes to satisfying consumer needs," and the product price is unavoidable in determining the impact of revisit intention. Customers are typically price conscious as a sign of thriftiness, and they form their opinion of a supplier by comparing price differences between products or services (Raji., 2017). Despite differences in consumer experience under different conditions, product price influences consumer attitudes and, as a result, customer revisits intention is prevalent in green restaurants. Product price variations influence customer expectations, evaluation, and decision-making in the green restaurant industry (Bhattacharjee et al., 2018). The fourth hypothesis contends that green restaurant products' prices influence consumers' willingness to return. As a result, to retain and attract customers, the price of goods or services must be reasonably compared to the quality of the goods or services (Han., 2015). Customers who dine at green restaurants are usually aware that they cannot afford to spend more money than they have. As a result, product pricing may influence a customer's purchasing decisions (Polas, Imtiaz, Mahbub, & Khan, 2019). Above all, the type and frequency of price fluctuations increase customer vulnerability in Malaysian green restaurants. This flaw perplexes the customer, influencing his or her decision to purchase the product or service (Tayara & Raju, 2020)

### **Research Hypothesis**

According to the research analysis, independent factors such Green Consumerism, Green perceived value, Green Perceived Quality, and Product Price do affect the consumers to Revisit Intention in Green Restaurants The study's hypotheses were outlined as follows in light of the literature reviewed:

**H<sub>1</sub>** There is a relationship between green consumerism and revisit intention.

**H<sub>2</sub>** There is a relationship between green perceived value and revisit intention.

**H<sub>3</sub>** There is a relationship between perceived quality and revisit intention.

**H<sub>4</sub>** There is a relationship between product price and revisit intention.

### **Research Framework**

Conceptual framework describes the significant factors that influence the revisit intention of a green restaurant in Malaysia using references from the literature review. Figure 1.1 depicts the conceptual framework for this study. Green consumerism, green perceived value, green perceived quality, and product price are the four independent variables. The dependent variable is the intention to revisit green restaurant in Malaysia.

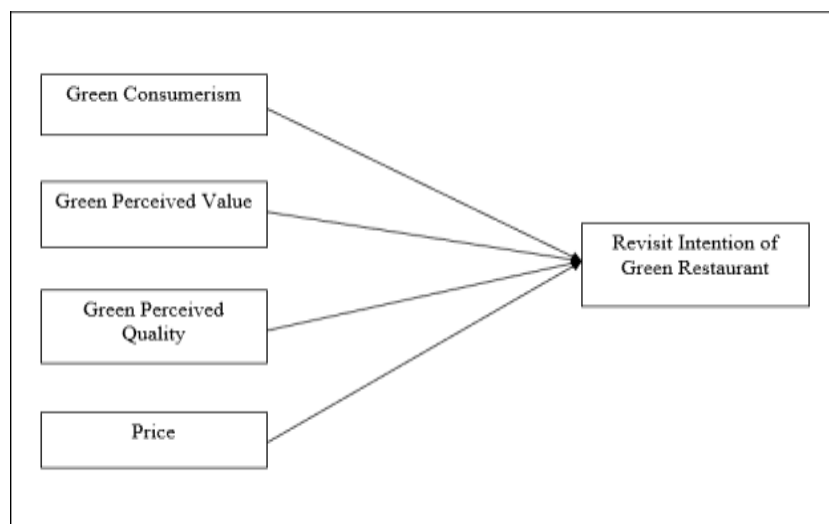

Figure 1.1 Conceptual Framework

## METHODOLOGY

### Research Design

As a result, this study used a correlational research design rather than a causal design. This study uses a cross-sectional survey method to gather information on the Malaysian consumers intend to go to more green restaurants.

### Data Collection

This study conducted by self-administered questionnaire and consisted of a five-point interval scale for respondents to choose. The questionnaire was distributed among 250 Malaysian consumers (18 years and above) who have visited a green restaurant in Malaysia at least once. The questionnaire was collected through online surveys to reach the respondent in Malaysia.

### Sampling

A quantitative researcher tends to use a type of sampling method based on the criterion suitable for the study which is probability sampling or non-probability sampling methods. In probability sampling, each subject has a known chance or non-zero chance of being selected from the population as a subject in the survey. In this study, it was decided to adopt non-probability sampling methods through the purposive sampling method. Purposive sampling was used in this study because the researcher is aware of the specific characteristics of the population of respondents.

### Data Analysis

The data in this study were analyzed using with Statistical Package for Social Sciences (SPSS) version 28.0 to analyze the data for descriptive analysis and correlational analysis. SPSS is computer software to help researchers analyze and transform data into graphs or tables. It helped the researcher to reduce the time it took to calculate the primary data. When many constructs are unobservable, SPSS is a valuable tool in the behavioral and social sciences. SPSS helps researchers determine each concept's one-dimensionality, reliability, and validity. As a result, SPSS was used for data analysis in this study to answer the research questions and objectives.



## FINDINGS

### Respondent Profile

Most respondents are consumers in Malaysia. Most were female (62.4%), and the remaining respondents (37.6%) were male. Regarding their age, the age of the respondents varied between 18 and 25 years; more than half of the respondents (38.8%) were aged between 26 and 35 years, (and 35.6%) of them were aged between 36 and 45 years (20.4%) and lowered the age of this frequency is analysis the respondents aged 46 years above which is (5.2%). As for the respondents' ethnicity, most were Malay (36.8%) compared to Chinese (36.4%), Indian (26.0%), and others (0.8%). The Marital Status of 250 respondents showed that single is more respondents percentage (58.0%) compared to married respondents (42.0%). Regarding the highest education, more than half of the respondents held a degree (52.4%), with (24.4%) being a diploma. Only (0.4%) of respondents were Masters. Most respondents were from SPM (12.8%) and STPM (10.0%). Regarding occupation, the higher occupation respondent who revisits intention in Green Restaurant is employed (44.0%). The second higher revisit intention green restaurant is a student (30.8%) compared to self-employed (22.0%), and fewer respondent is unemployed (0.4%). Lastly, the descriptive analysis revealed that for most of the

respondent's household income, more than half of the respondent's income months were less than RM1000 – RM2000 (46.6%), with (26.8%) being income months from RM2001 – RM3000. The less respondent revisit intention in green restaurant income month more than RM5001, which is (10.4%)

Table 1: Respondent Profile

Demographic Profile		Frequency (N=250)	Percentage (%)
<b>Gender</b>	Male	94	37.6
	Female	156	62.4
<b>Age</b>	18-25 years	97	38.8
	26-35 years	89	35.6
	36-45 years	51	20.4
	46 years above	13	5.2
<b>Race</b>	Malay	92	36.8
	Chinese	91	36.4
	Indian	65	26.0
	Others	2	0.8
<b>Marital Status</b>	Single	145	58.0
	Married	105	42.0
<b>Highest Education</b>	SPM	32	12.8
	STPM	25	10.0
	Diploma	61	24.4

	Degree	131	52.4
	Others	1	.4
<b>Occupation</b>	Student	77	30.8
	Employed	110	44.0
	Self-employed	55	22.0
	Unemployed	8	3.2
<b>Household Income (per month)</b>	< RM1000 – RM2000	104	41.6
	RM2001 – RM3000	67	26.8
	RM4001 – RM5000	43	17.2
	> RM5001	26	10.4
	Others	6	4.0

### Result of Descriptive Analysis

The following criteria based on the mean scores were used to determine the levels of agreement for each variable. A mean score less than 2.49 were categorised as ‘low’, between 2.50 to 3.49 as ‘moderate’ and more than 3.50 as ‘high’.

The result in Table 2 shows descriptive analysis with an independent variable that the item of perceived value has the highest mean score (4.66), (0.51). Meanwhile, the item on green consumerism shows the lowest mean score (4.5864), (0.56878). As for the item of product price, the score means (4.6568), (0.54291). The lowest score means for the independent variable shows perceived quality (4.6304), (0.54665). Meanwhile, the score means dependent variable in item Revisit intention shows (5.8880), (1.10469).

*Table 2: Descriptive Analysis*

Variables	No of Items	Mean Score (M)	Standard Deviation (SD)
<b>Green Consumerism</b>	5	4.59	.56878
<b>Green Perceived quality</b>	5	4.63	.54665
<b>Green Perceived Value</b>	5	4.67	0.51
<b>Product Price</b>	5	4.66	.54291
<b>Revisit Intention</b>	4	5.89	1.10469

### Result Correlation Analysis

One of the essential statistical methods for determining the linear relationship between two numerical variables is the Pearson correlation test. Pearson’s correlation is used to provide a more accurate measure of whether the correlation coefficient is significant. According to Hair (2010), the correlations between the variables were analyzed to examine the relationships between the variable of the model (significant and positive correlations). Correlation (\*\*) means the relationship is at 95% confidence. A significant level is generated when the Sig values are obtained more or less than 0.05. Pearson correlation was used to analyze the data to identify the relationship between two variables in which the

lower scale (or both) is on the scale of the interval. The strength of the relationship is represented by the value of the coefficients of correlation as follows:

Table 3: Show the coefficient range, r

Coefficient range, r	Strength of association
0.91 to 1.0 / - 0.91 to -1.0	Very strong
0.71 to 0.90 / - 0.71 to - 0.90	High
0.51 to 0.70 / - 0.51 to - 0.70	Moderate
0.31 to 0.50 / - 0.31 to - 0.50	Small but define relationship/weak
0.01 to 0.30 / - 0.01 to - 0.30	Slight, almost negligible

Source: Konting, 2000

Table 4 points out a significant link between each independent variable (Green Consumerism, Green Perceived Quality, Green Perceived Value, Product Price) with the dependent variable, revisit intention on green restaurant. Based on the result, there is a relationship between independent and dependent variables. Thus, the following hypotheses are accepted:

Table 3: Correlation between independent variable and dependent variable

		REVISIT INTENTION	GREEN CONSUMERISM	PERCEIVED QUALITY	PERCEIVED VALUE	PRICE PRODUCT
INTENTION	Correlation	1	.637**	.487**	.493**	.510**
	Sig. (2-tailed)		.000	.000	.000	.000
	N	250	250	250	250	250
CONSUMERISM	Correlation	.637**	1	.663**	.722**	.657**
	Sig. (2-tailed)	.000		.000	.000	.000
	N	250	250	250	250	250
QUALITY	Correlation	.487**	.663**	1	.740**	.663**
	Sig. (2-tailed)	.000	.000		.000	.000
	N	250	250	250	250	250
VALUE	Correlation	.493**	.722**	.740**	1	.733**
	Sig. (2-tailed)	.000	.000	.000		.000

	N	250	250	250	250	250
	Correlation	.316	.007	.000	.733	1
PRICE	Sig. (2-tailed)	.000	.000	.000	.000	
		---	---	---	---	---

## DISCUSSION AND RECOMMENDATION

A green restaurant has better chances of getting repeat business that demonstrates a commitment that satisfies their subconscious expectations during their visit. First of all, There is no physical interaction because the study's data was only gathered online and reduces our experience connection. There is a association between green consumerism and revisit intention of green restaurants in Malaysia. This study supported by (Warburg et al, 2021) that customer become more worried about the environmental impact of commercial activities that are becoming popular vocal supporter of responsible individual behaviour. Second attribution accepted. There is a association between green perceived value and the revisit intention of green restaurants in Malaysia. According to (Juliana et al., 2020) Customers' overall evaluation a market offering's received benefit is based on their needs, wants, and expectations with regard to sustainability, which are referred to as green perceived value.

Hence, hypothesis 3 accepted. There is a connection between a green restaurant's will to return and its perceived green qualities in Malaysia. In this study of (Ahn & Kwon, 2020) evidence suggests that ecologically conscientious customers are more likely to visit restaurants that are considered as having a high level of green quality. Next, this study supported by (Bhattacharjee et al., 2018) that Price variations influence customer expectations, evaluation, and decision-making in the green restaurant industry.

In the future, our recommendation could emphasize connection between people in person and online, perhaps producing intriguing outcomes. Second, Participants were asked to answer based on their most recent encounter with green consumption and the cost of the item. Due to the time-lapse, A large portion of the participants struggled to remember the occurrence, and a small number of them could only recall a few details relating to the green practice rather than all of them. This study also employs a cross-sectional research design, with participants responding only once. As a result, the current study suggests expanding the investigation using a long-term research approach, in which the same respondents may be questioned more than once over time.

Additionally, the current study included green restaurants from a variety of cultures and communities, uniformly supporting the idea that patrons choose green restaurants based on their environmental value, quality, and product price. Future research could also concentrate on the divergence of service failure based on consumers experiences in green restaurants in Peninsular Malaysia. In future studies, we may consider increasing the sample size and including other factors influencing green restaurant revisit intention among consumers to improve the advanced model of the research study.

## CONCLUSION

The analysis revealed that performance green consumerism, perceived value, perceived quality, and product price positively influence consumers' revisit intention in the green restaurant. The findings revealed that perceived value had among the most important impact regarding the desire to dine at green restaurants again. It is possible to use additional

hypotheses to direct future research into the characteristics that motivate customers to return to green restaurants.

## REFERENCES

- Agnihotri, D., & Chaturvedi, P. (2018). A study on impact of service scape dimensions on perceived quality of customer with special reference to restaurant services in Kanpur. *International Journal of Management Studies*, 3(7). [https://doi.org/10.18843/ijms/v5i3\(7\)/14](https://doi.org/10.18843/ijms/v5i3(7)/14)
- Ahn, J., & Kwon, J. (2020). Green hotel brands in Malaysia: Perceived value, cost, anticipated emotion, and revisit intention. *Current Issues in Tourism*, 23(12), 1559–1574. <https://doi.org/10.1080/13683500.2019.1646715>
- Ajzen, I. (1991). The theory of planned behaviour. *Organizational Behaviour and Human Decision Processes*, 50(2), 179–211. [https://doi.org/10.1016/0749-5978\(91\)90020-T](https://doi.org/10.1016/0749-5978(91)90020-T)
- Akter, M., Sadekin, M. N., & Patwary, A. K. (2020). An Empirical Study on Students' Satisfaction from Mawlana Bhashani Science & Technology University, Bangladesh. *Review of Economics and Development Studies*, 6(2), 363-379.
- Alamsyah, D., Othman, N., Bakri, M., Udjaja, Y., & Aryanto, R. (2021). Green awareness through environmental knowledge and perceived quality. *Management Science Letters*, 11(1), 271–280. <https://doi.org/10.5267/j.msl.2020.8.006>
- Atzori, R., Shapoval, V., & Murphy, K. S. (2018). Measuring generation Y consumers perceptions of green practices at Starbucks: An IPA analysis. *Journal of Foodservice Business Research*, 21(1), 1–21. <https://doi.org/10.1080/15378020.2016.1229090>
- Chen, Y. S., & Chang, C. H. (2012). Enhance green purchase intentions: The roles of green perceived value, green perceived risk, and greentrust. *Management Decision*, 50(3), 502–520. <https://doi.org/10.1108/00251741211216250>
- Fengmin, Z., Baijun, W., Jiangtao, B., Li, L., & Patwary, A. K. (2022). Investigating revisit intention of medical tourists in China through nutritional knowledge, perceived medical quality, and trust in the physiologist: A recommendation on health tourism policy measures. *Frontiers in Public Health*, 10, 893497.
- Hair, J. F., Risher, J. J., Sarstedt, M., & Ringle, C. M. (2019). When to use and how to report the results of PLS-SEM. *European Business Review*, 31(1), 2–24. <https://doi.org/10.1108/EBR-11-2018-0203>
- Hojnik, J., Ruzzier, M., & Manolova, T. S. (2020). Sustainable development: Predictors of green consumerism in Slovenia. *Corporate Social Responsibility and Environmental Management*, 27(4), 1695–1708. <https://doi.org/10.1002/csr.1917>  
<https://doi.org/10.1080/15256480.2018.1464421>
- Jang, Y. J., Kim, W. G., & Bonn, M. A. (2016). Generation Y consumers selection attributes and behavioral intentions concerning green restaurants. *International Journal of Hospitality Management*, 30(4), 803–811. <https://doi.org/10.1016/j.ijhm.2010.12.012>

- Jiang, Y., & Hong, F. (2021). Examining the relationship between customer-perceived value of night-time tourism and destination attachment among generation Z tourists in China. *Tourism Recreation Research*, 1–14. <https://doi.org/10.1080/02508281.2021.1915621>
- Journal of Contemporary Hospitality Management*, 29(9), 2464–2482. <https://doi.org/10.1108/IJCHM-08-2016-0439>
- Juliana, J., Djakasaputra, A., & Pramono, R. (2020). Green perceived risk, green viral communication, green perceived value against green purchase intention through green satisfaction. *Journal of Industrial Engineering and Management Research*, 1(2), 124–139.
- Kim, D. Y., & Park, S. (2020). Rethinking millennials: How are they shaping the tourism industry? *Asia Pacific Journal of Tourism Research*, 25(1), 1–2. <https://doi.org/10.1080/10941665.2019.1667607>
- Kim, S. H., Lee, K., & Fairhurst, A. (2017). The review of “green” research in hospitality, 2000-2014: Current trends and future research directions. *International Journal of Contemporary Hospitality Management*, 29(1), 226–247. <https://doi.org/10.1108/IJCHM-11->
- Kwok, L., Huang, Y.-K., & Hu, L. (2016). Green attributes of restaurants: What really matters to consumers? *International Journal of Hospitality Management*, 55, 107–117. <https://doi.org/10.1016/j.ijhm.2016.03.002>
- Langgat, J. (2020). Route to Green Restaurant: Malaysian perceptions and attitudes. *International Journal of Business and Social Science*, 11(5), 9–17. <https://doi.org/10.30845/ijbss.v11n5a2>
- Lavuri, R. (2021). Extending the theory of planned behavior: Factors fostering millennials intention to purchase eco-sustainable products in an emerging market. *Journal of Environmental Planning and Management*, 1–23. <https://doi.org/10.1080/09640568.2021.1933925>
- Li, L., Ragavan, N. A., Patwary, A. K., & Baijun, W. (2022). Measuring patients' satisfaction toward health tourism in Malaysia through hospital environment, nutritional advice, and perceived value: A study on Chinese exchange students. *Frontiers in public health*, 10, 893439.
- Li, L., Wu, B., & Patwary, A. K. (2022). How marine tourism promote financial development in sustainable economy: new evidences from South Asia and implications to future tourism students. *Environmental Science and Pollution Research*, 29, 1155-1172.
- Li, L., Wu, B., & Patwary, A. K. (2022). The psychosocial factors affecting chinese Outbound Exchange and mobility students' academic performance during COVID-19. *Frontiers in psychology*, 13, 872516.
- Liao, X., Shen, S. V., & Shi, X. (2020). The effects of behavioral intention on the choice to purchase energy-saving appliances in China: The role of environmental attitude, concern, and perceived psychological benefits in shaping intention. *Energy Efficiency*, 13(1), 33–49. <https://doi.org/10.1007/s12053-019-09828-5>
- Liobikienė, G., Mandravickaitė, J., & Bernatoniene, J. (2016). Theory of planned behavior approach to understand the green purchasing behavior in the EU: A cross-cultural

- study. *Ecological Economics*, 125,38–46.  
<https://doi.org/10.1016/j.ecolecon.2016.02.008>
- Liu, C. R., Chiu, T. H., Wang, Y. C., & Huang, W. S. (2020). Generation Ys revisit intention and price premium for lifestyle hotels: Brand love as the mediator. *International Journal of Hospitality and Tourism Administration*, 21(3), 242–264.
- Mao, Z., & Lyu, J. (2017). Why travelers use Airbnb again? An integrative approach to understanding travelers repurchase intention. *International*
- Mohd Suki, N. (2015). Executive summary of “does religion influence consumers’ green food consumption? some insights from Malaysia.” *Journal of Consumer Marketing*, 32(7). <https://doi.org/10.1108/jcm-11-2015-053>
- Nekmahmud, M., & Fekete-Farkas, M. (2020). Why not green marketing? determinates of consumers’ intention to green purchase decision in a new developing nation. *Sustainability*, 12(19), 7880. <https://doi.org/10.3390/su12197880>
- Nicolau, J. L., Guix, M., Hernandez-Maskivker, G., & Molenkamp, N. (2020). Millennials willingness to pay for green restaurants. *International Journal of Hospitality Management*, 90, 102601. <https://doi.org/10.1016/j.ijhm.2020.102601>
- Park, E. (O., Chae, B. (K., Kwon, J., & Kim, W.-H. (2020). The effects of Green Restaurant attributes on customer satisfaction using the structural topic model on online customer reviews. *Sustainability*, 12(7), 2843. <https://doi.org/10.3390/su12072843>
- Patterson, P. G., & Spreng, R. A. (1997). Modelling the relationship between perceived value, satisfaction and repurchase intentions in a business-to-business, services context: An empirical examination. *International Journal of Service Industry Management*, 8(5), 414–434. <https://doi.org/10.1108/09564239710189835>
- Sumethokula, P., Patwary, A. K., Srinuanpanc, B., Srinuanpand, C., Suwandeey, P., Thammathikul, A., & Phanong, W. (2020). The potential of new tour repackaging for creative tourism among entrepreneurs in Nakhon Si Thammarat. *International Journal of Innovation, Creativity and Change*, 13(10), 1752-1771.
- Wu, B., Liu, S., Wang, J., Tahir, S., & Patwary, A. K. (2021). Assessing the mechanism of energy efficiency and energy poverty alleviation based on environmental regulation policy measures. *Environmental Science and Pollution Research*, 28, 40858-40870.
- Wu, B., Zhai, B., Mu, H., Peng, X., Wang, C., & Patwary, A. K. (2021). Evaluating an economic application of renewable generated hydrogen: A way forward for green economic performance and policy measures. *Environmental Science and Pollution Research*, 1-15.

# **Factor Influencing Online Repurchase Intention Among Cosmetic Consumers In Malaysia**

**Afiq Bin Khairil Anuar, Fatihatul Najjah Binti Mohd Nor, Liyana Sahira Binti Mohd Zuki, Marina Binti Sudarman\*Nurul Hafizah Mohd Yasin**

*Faculty of Hospitality, Tourism and Wellness, Universiti Malaysia Kelantan Corresponding*

*email: [Hafizah.my@umk.edu.my](mailto:Hafizah.my@umk.edu.my)*

## **ABSTRACT**

E-commerce is a growing market, the number of retailers and the growth in online shopping has built up a competitive market. In Malaysia, online repurchasing shows encouraging progress among consumers. The convenience side of online shopping, such as practicality, has strengthened shoppers' intentions to repurchase online. Therefore, this study aims to determine the factors that influence cosmetic consumers' intention to online repurchase the cosmetic products. This study employed a cross-sectional research design by using a non-probability sampling method. The proposed model is an extension UTAUT and was empirically tested using data obtained from an online survey of online cosmetic shoppers (n=256). A total of 256 data were analyzed using the Statistical Package for the Social Sciences (SPSS). The analysis revealed that security, trust, ease of use, privacy concern and product price has a positive influence on the online repurchase intention among cosmetic consumer. The findings revealed that security had the greatest impact on the intentions to online repurchase among cosmetic consumer. Other theories can be applied to guide future studies to discover more factors that influence online cosmetic shopper to repurchase.

**Keyword: Repurchase Intention of Cosmetic Consumer, Security, Trust, Ease of Use (EOU), Privacy Concerns, Product Price.**

## **INTRODUCTION**

Repurchase intention is defined as a "the subjective probability that a consumer or an experienced customer will continue to purchase a product from the same online supplier" (Chiu et al.,2015). Previous studies have defined that price and safety factors are one of the most important aspects in buying products online. This is because the price is one aspect that reflects the quality of the product and influences the image of the product so that customers or experienced users continue to buy products online. Online repurchasing is very useful to customers or consumers as they can shop anytime and anywhere.

Therefore, this study is aimed to assess the factor influencing online repurchase intention among cosmetic consumers In Malaysia. The outcomes of this study were useful for the researchers to understand the relationship between security, privacy concerns, trust, ease of use (EOU), product price, and repurchase intention.

There were five objectives of this research:

To identify the relationship between security and repurchase intention among online cosmetics consumer in Malaysia.

To determine the relationship between trust and repurchase intention among online cosmetics consumer in Malaysia.



To identify the relationship between ease of use and repurchase intention among online cosmetics consumer in Malaysia.

To determine the relationship between privacy concern and repurchase intention among online cosmetics consumer in Malaysia.

To determine the relationship between product price and repurchase intention among online cosmetics consumer in Malaysia.

## **SIGNIFICATION OF THE STUDY**

### ***Health Ministry***

The importance of this study will be able to provide various information to the Ministry of Health to take appropriate action to cosmetic users in Malaysia. This study also gives ideas to the government to implement various related programs such as online cosmetics purchasing programs, cosmetic user implementation seminars, cosmetic product exhibitions and conferences. In daily life, this program can help users to get more in-depth information about the purchasing intentions of cosmetic users in Malaysia.

### ***Consumers***

This researcher can directly benefit consumers in Malaysia to raise awareness about the intention to make online purchases among cosmetic consumers because security, trust, ease of use, privacy concern and product price can give consumers the opportunity to review their intentions towards cosmetic consumers in Malaysia.

## **LITERATURE REVIEW**

### **Repurchase Intention of Cosmetic Consumers**

Repurchase intention can be defined as the judgment made by each consumer regarding repurchase in the same company William & Auchil et al., (2021). The customer has a certain reason to make such a decision because for the customer to choose a service provider and buy each of the same services is one of their previous experiences. This repurchase intention is one of the individual's or customer's judgments about the same company that has met the needs and evaluation of a good and current service situation McDougall & Levesque et al., (2020). Repurchase intention among customers depends on the value obtained in their past transactions when making a purchase for example appropriate performance criteria (product benefits), competition and cost considerations. Kaynak et al., (2021). The intention to repurchase in the future also has a significant relationship with customer satisfaction Durvasula et al., (2018). Overall from this study, customers have intentions to repurchase in the future based on the value they get from previous contacts or from the services provided.

### **Security**

Security is one of the main challenges in e-business, according to Kalakota and Whinston et al., (2015) it is one of "situations, circumstances, or events that have the potential to cause financial difficulties to data or network resources through destruction, exposure, alteration, denial of service, or abuse, waste and fraud. Security is an electronic channel that relies on various elements of online technology including encryption, digital signatures and certificates, according to Klang et al., (2020). E-commerce businesses should be concerned about measures security in a way that inspires customers to buy cosmetics online and gives them confidence that the danger of fraud can be reduced. A study by Hartono et al., (2015) found that websites with a higher level of security can protect their users from financial loss due to security issues. For example, credit card information leaks. Theoretically, many academics have drawn conclusions about the

relationship between customers' propensity to repurchase cosmetics and safety. The researchers concluded that when there is a high level of security, cosmetic customers are more likely to make repeat purchases when they are satisfied with the security offered by e-commerce businesses. Therefore, good safety can influence consumers' propensity to repurchase cosmetics.

### **Trust**

Trust is a person's willingness to be exposed to the actions of another party with the expectation that the other party will act in a manner related to the Trustee, according to (Mayer, Davis, and Schoorman 2015). According to (Morgan and Hunt 2019), a trustee is someone who will act in the interests of the trust and without malicious intent. Trust is one of the important elements that determine a person's commitment to a relationship. Moreover, it claims that trust has a great impact on the commitment of each user. This confidence is essential for business success. Consumers' confidence in the ability of internet companies to act responsibly is greatly influenced

by their level of trust. Many researchers have concluded that one of the initial actions that consumers should take when accessing a website is to confirm its credibility in order to foster the confidence necessary for consumers to continue visiting the site since trust is important and has a great influence on repurchase intentions. . Building a strong reputation should be the main goal for businesses involved in e-commerce because it can win customers' trust and motivate them to make additional purchases.

### **Ease Of Use (EOU)**

EOU has a significant impact on the extent to which technology is accepted. A technology will be chosen over an alternative if it is easy to use. EOU has an indirect effect on attitude intention, but this effect is due to an indirect mediating effect on perceived usefulness, according to the TAM stated in the 2019 study. A significant negative correlation between risk perception and attitude towards online purchases was shown in Van's study Heijden et al., (2015). This implies that as perceived risk increases, customer attitudes toward online shopping will become less favorable. Consumers' willingness to make additional purchases will undoubtedly suffer if using online marketplaces is plagued by major technology issues

### **Privacy Concern**

According to Belanger et al., (2020) "The willingness of users to provide information through the Internet that enables purchases to be made" is one way to determine privacy. Personal information online is usually a problem for privacy. Online businesses can create privacy policies that consider notification, transparency and customer preferences or consent to address privacy concerns. Some privacy concerns, including the need for secure third-party authentication or laws and regulations generated by an efficient e-business infrastructure, can help win consumer trust in online marketplaces. Additionally, many studies have shown that privacy has a significant impact on online purchase intentions to purchase and repurchase. The findings of Klang et.al (2020) reveal that although recent advances in technology and legal means to protect identity and payments have evolved, the impact on electronic transactions has been disappointing. The danger associated with online purchases is that users' personal information may be voluntarily provided or may be stolen and used by third parties to send spam to users. Due to this, user privacy is affected. Although the impact of a privacy breach may not be as severe as the loss of financial data, it results in consumers' distrust of online retailers and affects their intention to repurchase cosmetics.

### **Product Price**

Price is defined as the customer's money exchange in terms of service or product, or the value they receive Kotler and Armstrong et al., (2020). It is important for companies to retain loyal customers who are willing to pay higher prices for their favourite brands and not buy based on lower prices. Wickliffe & Pysarchik et al., (2021) introduced product aspects as characteristics that have an inherent effect on repurchase intentions such as brand and price. these two factors include the main part of the product characteristics. Price is one of the important factors in customer repurchase, thus consumer satisfaction is influenced by the perception of product price. directly it is affected by price fairness indirectly. In another study, lee et al., (2018) examined the effect of consumers' perception of price fairness on their purchase decisions and referred to it as a suitable predictor for consumers' repurchase decisions. (Jehri and Sahaskmontri 2018) also stated good value in exchange for receiving money among the criteria taken into account by consumers. According to Khraim et.,al (2021) product price has a significant effect on brand loyalty which in turn affects customers for repurchase intentions

### **Research Hypothesis**

The literature review highlights that independent variables such as Security, Trust, Ease of Use, Privacy Concern and Product Price influence the repurchase Intention of cosmetic consumer. Based on the literature discussed, the hypothesis of this study is summarized as follows:

**H<sub>1</sub>** There is a positive relationship between security and online repurchase intention.

**H<sub>2</sub>** There is a positive relationship between trust and online repurchase intention

**H<sub>3</sub>** There is a positive relationship between ease of use and online repurchase intention

**H<sub>4</sub>** There is a positive relationship between privacy concerns and online repurchase intention

**H<sub>5</sub>** There is a positive relationship between product price and online repurchase intention

### **Research Framework**

The research framework is illustrated as shown in Figure 1 to investigate the relationship between Security, Trust, Ease of Use, Privacy Concern and Product Price to repurchase Intention of cosmetic consumers. The independent variables are Security, Trust, Ease of Use, Privacy Concern, and Product Price. The dependent variable is Repurchase Intention of Cosmetic Consumer.

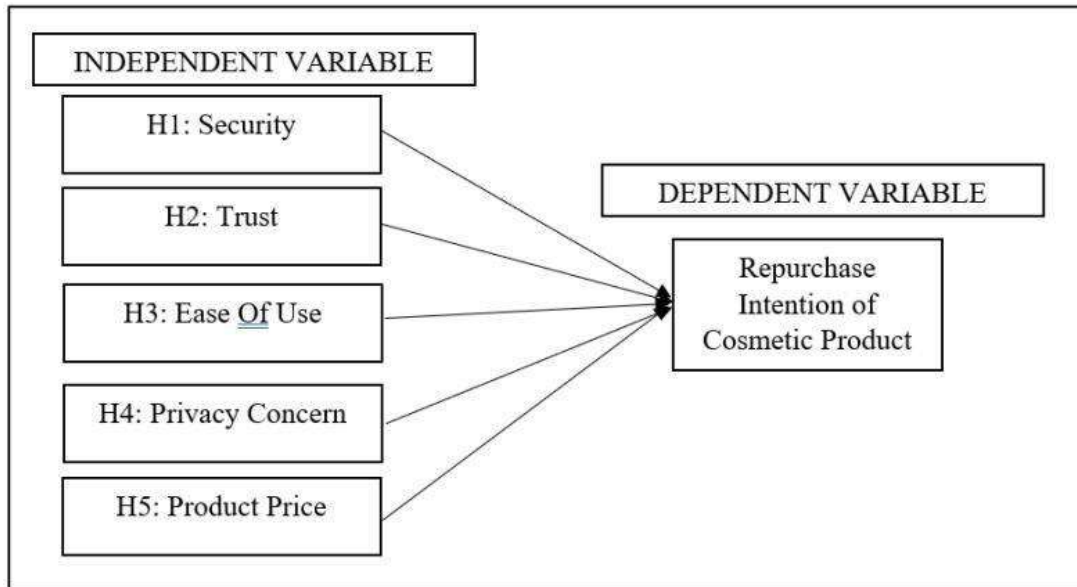

**Figure 1 : Research framework**

## **METHODOLOGY**

### **Research Design**

This research study is about the factors that influence online repurchase intentions among cosmetic consumers in Malaysia. The study design is a cross-sectional study. Cross sectional study research design had been used in this research proposal. The research strategy through survey research has been used for getting information. The researcher has used a questionnaire to identify the level of online repurchase intention among cosmetic consumers in Malaysia.

### **Data Collection**

The data of this study will be collected according to the random sampling method. Data collection will highlight the factors that influence online repurchase intentions among cosmetic consumers, and there are 250 questionnaires that will be given to cosmetic consumers who often make online purchases in Malaysia. It will use a platform through Google forms to make it easier for respondents to answer. Data collection will be processed when the researcher searches for data information through reading and observation to record the data obtained.

### **Sampling**

Purposive sampling is a type of non-likelihood sampling strategy in which experts use their own judgement in selecting persons from the population to participate in their investigations. In general, non-probability sampling techniques are appropriate for studies assessing the theoretical influence based on a conceptual framework.

### **Data Analysis**

This research was the primary data and the data collected through the questionnaire. The data in this study was analysed using the Statistical Package for the Social Sciences (SPSS) version 22.0. SPSS is a computer software to help researchers analyze the data and transform data to the graph or tables. It helped researchers to reduce the Strongly Agree Strongly Disagree time to calculate the primary data. The researcher coded the questionnaire and key into the data file.

After key in, researchers moved to the next procedure. The data analysis collection was categorized by descriptive statistics and multiple regressions.

## FINDINGS

### Results of Frequency Analysis

Most respondents were young adults in Malaysia; the majority were female (61.8%), and the remaining respondents (38.2%) were male. Regarding their age, the age of the respondents varied between 18 until 56 years. More than half of the respondents (63.3%) aged between 18 and 25 years, (18.7%) of them aged from 26 and 35 years, (15.1%) of them are aged from 36 and 45 years old. As for the respondents' ethnicity, most were Malay (56.2%) compared to Chinese (26.3%), Indian (6.8%), and others (4.2%). In terms of education, more than half of the respondents held a degree (57.4%), with (25%) being diploma. Only (1.3%) of respondents were doctoral. Most of the respondents from SPM (12.8%) and master (3.5%). In terms of Residential area, more than half of the respondents held an urban (46.2%), with (21.5%) being suburban. Only (32.4%) of respondents were rural. Lastly, the descriptive analysis revealed that most of the respondents Religion, most were Muslim (51.3%) compared to Buddha (15.7%), Hindu (27.6%), Christian (3.8 %) and others (1.6%).

*Table 1: Frequency Analysis*

	Demographic Profile	Frequency	Percentage (%)
<b>Gender</b>	Male	96	38.2
	Female	155	61.8
<b>Age</b>	18-25 years	159	63.3
	26-35 years	47	18.7
	36-45 years	38	15.1
	46-55 years	5	2.0
	56 years above	2	8
<b>Religion</b>	Malay	141	56.2
	Chinese	66	26.3
	Indian	17	6.8
<b>Status</b>	Married	69	27.5
	Single	182	72.5
	Others		
<b>Highest Education Level</b>	Degree	159	63.3
	Diploma	41	16.3
	Matrikulasi	1	.4
	SPM	15	6.0
	STPM	35	13.9
<b>Employment status</b>	Employed	49	19.5

	Self-Employed	48	19.1
	Student	145	57.8
	Unemployed	9	3.6
<b>Income</b>	Below RM1000	128	50.0
	RM 1001- RM 2000	52	20.3
	RM2001- RM3000	33	12.9
	Above RM4001	43	16.8

## Result of Descriptive Analysis

The mean score and standard deviation of the variable are shown in Table 2. The following criteria are based on the mean scores were used to determine the levels of agreement for each variables. The factors can be considered low if the mean score is form 1.00 to 1.99 and high if the mean score from 2.00 to 4.00. Table 2 shows result of descriptive analysis:

*Table 2: Descriptive Analysis for Each Construct*

Variables	No of Items	Mean Score (M)	Standard Deviation (SD)
Repurchase Intention of Cosmetic Consumers	4	4.8145	1.29052
Security	4	3.5410	.79661
Trust	4	3.6416	.79596
Ease of Use (EOU)	4	3.7402	.88943
Privacy Concern	4	3.7402	.88943
Product Price	4	4.0381	.85363

Table 2 shows the mean and standard deviation of 24 statements under five independent variables and four statements under dependent variables based on a survey involving 256 respondents. The results in table 2 above show that the Security item has the lowest mean score ( $3.5410 \pm .79661$ ). For the Trust variable, it has the lowest mean score ( $3.6416 \pm .79596$ ). Furthermore, the Ease of Use variable showed the highest mean score ( $3.7402 \pm .88943$ ). For the Privacy Concern variable, the mean score is the same as the Ease of Use variable ( $3.7402 \pm .88943$ ) while for Product Price it shows the highest mean score ( $4.0381 \pm .85363$ ). The last one for the dependent variable for the cosmetic consumer showed the highest mean score ( $4.8145 \pm 1.29052$ ).

## Result of Convergent Reliability

*Table 3: Convergent Reliability*

Constructs	Items	Loadings	AVE	CR
<b>Security</b>	SEC 1	0.480	0.355	0.822
	SEC 2	0.596		
	SEC 3	0.611		
	SEC 4	0.679		
<b>Trust</b>	TRUST 1	0.597	0.299	0.776

	TRUST 2	0.614	
	TRUST 3	0.523	
	TRUST 4	0.434	
<b>Ease of Use (EOU)</b>	EOU 1	0.617	0.370 0.844
	EOU 2	0.613	
	EOU 3	0.634	
	EOU 4	0.566	
<b>Privacy Concerns</b>	PC 1	0.602	0.316 0.872
	PC 2	0.587	
	PC 3	0.512	
	PC 4	0.543	
<b>Product Price</b>	PP 1	0.635	0.360 0.875
	PP 2	0.567	
	PP 3	0.618	
	PP 4	0.578	
<b>Repurchase Intention of Cosmetic Consumer</b>	CC 1	0.574	0.336 0.813
	CC 2	0.605	
	CC 3	0.616	
	CC 4	0.519	

The measurement model can be confirmed valid and reliable if the loading is higher than 0.5, the average variance extracted (AVE) is higher than 0.5, and the composite reliability is higher than 0.7, respectively (Hair et al., 2017). Table 4 clearly illustrates that all the requirements to establish convergent validity have been fulfilled; hence, the study concludes that convergent validity was not a problematic issue for the study. The summary of convergent validity for the measurement model was summarized.

### Pearson Correlation Analysis

One of the essential statistical methods for determining the linear relationship between two numerical variables is the Pearson correlation test. Pearson's correlation is used to provide a more accurate measure of whether the correlation coefficient is significant. According to Hair (2010), the correlations between the variables were analysed to examine the relationships between the variable of the model (significant and positive correlations). Correlation (\*\*) means the relationship is at 95% confidence. A significant level is generated when the Sig values are obtained more or less than 0.05. Pearson correlation was used to analyse the data to identify the relationship between two variables in which the lower scale (or both) is on the scale of the interval. The strength of the relationship is represented by the value of the coefficients of correlation as follows:

*Table 4: Show the coefficient range, r*

Coefficient range, r	Strength of association
0.91 to 1.0 / -0.91 to -1.0	Very strong

0.71 to 0.90 / -0.71 to -0.90	High
0.51 to 0.70 / -0.51 to -0.70	Moderate
0.31 to 0.50 / -0.31 to -0.50	Small but define relationship/weak
0.01 to 0.30 / -0.01 to -0.30	Slight, Almost negligible

Source: Konting, 2000

Table 4 points out a significant link between each independent variable (Security, Trust, Ease of Use, Privacy Concerns, and Product Price to repurchase Intention of cosmetic products) with the dependent variable, repurchase intention of cosmetics products. Based on the result, there is a relationship between independent and dependent variables. Thus, the following hypotheses are accepted:

**Table 4.1 : Correlation between independent variable and dependent variable**

	CP	IV1	IV2	IV3	IV4	IV5
Pearson Correlation	1	.729**	.611**	.576**	.482**	.479**
CP Sig. (2-tailed)		.000	.000	.000	.000	.000
N	256	256	256	256	256	256
Pearson Correlation	.729**	1	.725**	.566**	.444**	.502**
IV1 Sig. (2-tailed)	.000		.000	.000	.000	.000
N	256	256	256	256	256	256
Pearson Correlation	.611**	.725**	1	.576**	.462**	.548**
IV2 Sig. (2-tailed)	.000	.000		.000	.000	.000
N	256	256	256	256	256	256
Pearson Correlation	.576**	.566**	.576**	1	.575**	.675**
IV3 Sig. (2-tailed)	.000	.000	.000		.000	.000
N	256	256	256	256	256	256
Pearson Correlation	.482**	.444**	.462**	.575**	1	.622**
IV4 Sig. (2-tailed)	.000	.000	.000	.000		.000
N	256	256	256	256	256	256
Pearson Correlation	.479**	.502**	.548**	.675**	.622**	1
IV5 Sig. (2-tailed)	.000	.000	.000	.000	.000	
N	256	256	256	256	256	256

## DISCUSSION & RECOMMENDATIONS



The findings of this study indicate that a variety of factors influence online repurchase intention among Malaysian cosmetic customers. The first research goal was to determine the association between security and repurchase intention among Malaysian online cosmetics users. According to the findings, there is a relationship between security and online repurchase intention. The aftereffects of this examination are in accordance with research led by Raman and Viswanathan (2011), Belanger (2002), and research by Alwafi (2016), the principal theory can be acknowledged.

The second goal is to examine the relationship between trust and repurchase intention among Malaysian online cosmetics consumers. According to the data, the association between trust and purchasing cosmetics online is quite beneficial. Moreover, trust significantly influenced the purchase intention of consumers' products as well as services (Chang et al., 2014; Rahman et al., 2020). Hence, advertising trust is one of the variables to assess in this study that may influence consumers' purchase intention on local cosmetic brands.

The research purpose was to determine the association between ease of use and repurchase intention among Malaysian online cosmetics consumers. There is a relationship between ease of use and repurchase intention. The results also revealed that perceived ease of use has a significant effect on the respondent's online repurchase intention through social media. The results seem to suggest that the respondents may tend to buy online through social media if the process of using social media in terms of ordering and delivering products or services is simple and easy to understand. (See Siew Sin, Khalil Md Nor, Ameen M Al-Agag1a,2012)

The fourth goal is to examine the association between privacy concerns and repurchase intention among Malaysian online cosmetics users. According to the findings, there is a relationship between privacy concerns and repurchase intention. These findings corroborate the results obtained in studies of Eastlick et al. (2006), Pavlou and Fygenon (2006), Van Slyke et al. (2006), and Venkatesh et al. (2002) in the context of online shopping. The strongest direct effect of privacy concerns is felt on repurchase intention.

In addition to the study's research purpose, researchers sought to evaluate the association between product pricing and repurchase intention among Malaysian online cosmetics users. The findings demonstrated that online shopping characteristics such as price had a relationship with the propensity to purchase cosmetic products online. Based on Bauboniene and Guleviciute, prices affect consumers' shopping online. Sociodemographic results show that consumer shop online more often due to low prices (Bauboniene & Guleviciute, 2015). It was identified that the reason consumers are shopping online is because consumers can compare prices and shop at lower prices. Consumer purchasing decisions are influenced by high or low prices. Purchase decisions are affected by the number of reviews only if the price level is high.

The recommendation is future research should expand the geographic coverage of the study with respect to the population and distribution of the questionnaire. The current study only focused on shoppers who have bought online among cosmetic consumers in Malaysia. Moreover, future research could extend the work of this study by using other study designs, such as an experimental study with an intervention to examine the causal relationships between the predictors and intention. Besides that, future research could use multiple informants to enhance the validity of the research findings as well. Furthermore, it suggested for future study to explore the effect of other psychological capital with respect to personal resources such as optimism and hope as a moderating role in strengthening the positive relationship intention to online repurchase. Finally, future work should examine whether adding other factors related to the

intention to online repurchase the cosmetic product and in turn improve the advanced model of the research framework.

## CONCLUSION

In conclusion, all independent variables such as Security, Trust, Ease of Use, Privacy Concerns and Product Price have a positive correlation with the dependent variable which is Repurchase Intention of Cosmetic Consumer. As a result, the analysis revealed that safety, trust, ease of use, privacy concerns and product price have a positive influence on online repurchase intentions among cosmetic consumers in Malaysia.

## REFERENCES

- Afshan, S. and Sharif, A. (2016), "Acceptance of mobile banking framework in Pakistan", *Telematics and Informatics*, Vol. 33 No. 2, pp. 370-387.
- Agustin, C. and Singh, J. (2020), "Curvilinear effects of consumer loyalty determinants in relational exchanges", *Journal of Marketing Research*, Vol. 42 No. 1, pp. 96-108.
- Akter, M., Sadekin, M. N., & Patwary, A. K. (2020). An Empirical Study on Students' Satisfaction from Mawlana Bhashani Science & Technology University, Bangladesh. *Review of Economics and Development Studies*, 6(2), 363-379.
- Al-Gahtani, S. and King, M. (2019), "Attitudes, satisfaction and usage: factors contributing to each in the acceptance of information technology", *Behaviour & Information Technology*, Vol. 18 No. 4, pp. 277-297.
- Alom, S., Patwary, A. K., & Khan, M. M. H. (2019). Factors affecting the turnover intention of Bangladeshi migrants in the United Arab Emirates: An empirical study on the hotel industry. *International Journal of Innovation, Creativity and Change*, 8(3), 344-360.
- Anderson, J.C. and Gerbing, D.W. (2018), "Structural equation modelling in practice: a review and recommended two-step approach", *Psychological Bulletin*, Vol. 103 No. 3, pp. 411-419.
- Anderson, R.E. and Srinivasan, S.S. (2022), "E-satisfaction and e-loyalty: a contingency framework", *Psychology & Marketing*, Vol. 20 No. 2, pp. 123-138.
- Aren, S., Güzel, M., Kabadayı, E. and Alpkan, L. (2019), "Factors affecting repurchase intention to shop at the same website", *Procedia – Social and Behavioral Sciences*, Vol. 99, pp. 536-544.
- Baptista, G. and Oliveira, T. (2015), "Understanding mobile banking: the unified theory of acceptance and use of technology combined with cultural moderators", *Computers in Human Behavior*, Vol. 50, pp. 418-430.
- Baron, R.M. and Kenny, D.A. (2016), "The moderator–mediator variable distinction in social psychological research: conceptual, strategic, and statistical considerations", *Journal of Personality and Social Psychology*, Vol. 51 No. 6, pp. 1173-1180.
- Bart, Y., Shankar, V., Sultan, F. and Urban, G.L. (2015), "Are the drivers and role of online trust the same for all web sites and consumers? A large-scale exploratory empirical study", *Journal of Marketing*, Vol. 69 No. 4, pp. 133-152.

- Belanger, F., Hiller, J.S. and Smith, W.J. (2022), "Trustworthiness in electronic commerce: the role of privacy, security, and site attributes", *The Journal of Strategic Information Systems*, Vol. 11 No. 3, pp. 245-270.
- Benassi, P. (2019), "TRUST: an online privacy seal program", *Communications of the ACM*, Vol. 42 No. 2, pp. 56-59.
- Bhattacharjee, A. (2021), "Understanding information systems continuance: an expectation confirmation model", *MIS Quarterly*, Vol. 25 No. 3, pp. 351-370.
- Bryman, A. and Bell, E. (2015), *Business Research Methods*, Oxford University Press, Oxford.
- Chellappa, R.K. (2018), "Consumers' trust in electronic commerce transactions: the role of perceived privacy and perceived security", Under Submission.
- Chiu, C.-M., Wang, E.T.G., Fang, Y.-H. and Huang, H.-Y. (2022), "Understanding customers' repeat purchase intentions in B2C e-commerce: the roles of utilitarian value, hedonic value and perceived risk", *Information Systems Journal*, Vol. 24 No. 1, pp. 85-114.
- Chou, S., Chen, C.-W. and Lin, J.-Y. (2015), "Female online shoppers: examining the mediating roles of e-satisfaction and e-trust on e-loyalty development", *Internet Research*, Vol. 25 No. 4, pp. 542-561.
- Churchill, G. (2019), *Marketing Research*, Fryden Press, Orlando.
- Cranor, L.F., Reagle, J. and Ackerman, M.S. (2020), "Beyond concern: understanding net users' attitudes about online privacy", *The Internet Upheaval: Raising Questions, Seeking Answers in Communications Policy*, pp. 47-70.
- Cyr, D. (2018), "Modeling web site design across cultures: relationships to trust, satisfaction, and e-loyalty", *Journal of Management Information Systems*, Vol. 24 No. 4, pp. 47-72.
- Dagger, T.S. and O'Brien, T.K. (2020), "Does experience matter? Differences in relationship benefits, satisfaction, trust, commitment and loyalty for novice and experienced service users", *European Journal of Marketing*, Vol. 44 Nos 9/10, pp. 1528-1552.
- Davis, F.D. (2019), "Perceived usefulness, perceived ease of use, and user acceptance of information technology", *MIS Quarterly*, Vol. 13 No. 3, pp. 319-340.
- Davis, F.D., Bagozzi, R.P. and Warshaw, P.R. (1991), "User acceptance of computer technology: a comparison of two theoretical models", *Management Science*, Vol. 35 No. 8, pp. 982-1003.
- Dayal, S., Landesberg, H. and Zeisser, M. (2019), "How to build trust online", *Marketing Management*, Vol. 8 No. 3, pp. 64-69.
- Esch, F.R., Langner, T., Schmitt, B.H. and Geus, P. (2016), "Are brands forever? How brand knowledge and relationships affect current and future purchases", *Journal of Product & Brand Management*, Vol. 15 No. 2, pp. 98-105.
- Evanschitzky, H., Iyer, G.R., Hesse, J. and Ahlert, D. (2019), "E-satisfaction: a re-examination", *Journal of Retailing*, Vol. 80 No. 3, pp. 239-247.
- Fengmin, Z., Baijun, W., Jiangtao, B., Li, L., & Patwary, A. K. (2022). Investigating revisit intention of medical tourists in China through nutritional knowledge, perceived medical quality, and trust in the physiologist: A recommendation on health tourism policy measures. *Frontiers in Public Health*, 10, 893497.

- Fishbein, M. and Ajzen, I. (2015), *Belief, Attitude, Intention, and Behavior: An Introduction to Theory and Research*. Reading, Addison-Wesley, Boston, MA.
- Flavian, C., Guinaliu, M. and Gurrea, R. (2016), "The role played by perceived usability, satisfaction and consumer trust on website loyalty", *Information & Management*, Vol. 43 No. 1, pp. 1-14.
- Fornell, C. and Larcker, D.F. (2021), "Structural equation models with unobservable variables and measurement error: Algebra and statistics", *Journal of Marketing Research*, Vol. 18 No. 3, pp. 382-388.
- Gefen, D., Karahanna, E. and Straub, D.W. (2020), "Trust and TAM in online shopping: an integrated model", *MIS Quarterly*, Vol. 27 No. 1, pp. 51-90.
- Giovanis, A.N., Tomaras, P. and Zondiros, D. (2021), "Suppliers logistics service quality performance and its effect on retailers' behavioral intentions", *Procedia – Social and Behavioral Sciences*, Vol. 73, pp. 302-309.
- Goodhue, D.L. and Thompson, R.L. (2015), "Task-technology fit and individual performance", *MIS Quarterly*, Vol. 19 No. 2, pp. 213-236.
- Grabner-Kräuter, S. and Kaluscha, E.A. (2020), "Empirical research in on-line trust: a review and critical assessment", *International Journal of Human-Computer Studies*, Vol. 58 No. 6, pp. 783-812.
- Ha, H.Y., Janda, S. and Muthaly, S.K. (2020), "A new understanding of satisfaction model in e-repurchase situation", *European Journal of Marketing*, Vol. 44 Nos 7/8, pp. 997-1016.
- Hair, J.F., Anderson, R.E., Babin, B.J. and Black, W.C. (2020), *Multivariate Data Analysis: A Global Perspective*, Pearson, Upper Saddle River, NJ, Vol. 7.
- Hartono, E., Holsapple, C.W., Kim, K.Y., Na, K.S. and Simpson, J.T. (2019), "Measuring perceived security in B2C electronic commerce website usage: a respecification and validation", *Decision Support Systems*, Vol. 62, pp. 11-21.
- Hassanein, K. and Head, M. (2017), "Manipulating perceived social presence through the web interface and its impact on attitude towards online shopping", *International Journal of Human- Computer Studies*, Vol. 65 No. 8, pp. 689-708.
- Hazbar, A. M. H., Alem Mohammed, A., & Karim, A. K. A. (2019). An Empirical Study of Factors Influencing hotel customers' online booking Intention. *مجلة العلوم التربوية و الدراسات الإنسانية*, (5), 1-17.
- Igbaria, M., Zinatelli, N., Cragg, P. and Cavaye, A.L. (2017), "Personal computing acceptance factors in small firms: a structural equation model", *MIS Quarterly*, Vol. 21 No. 3, pp. 279- 305.
- Ismail, M.A. and Safa, N.S. (2018), "Trust, satisfaction, and loyalty formation in electronic commerce", *Journal of Industrial and Intelligent Information*, Vol. 2 No. 3, pp. 228-232.
- Jarvenpaa, S.L. and Todd, P.A. (2016), "Consumer reactions to electronic shopping on the world wide web", *International Journal of Electronic Commerce*, Vol. 1 No. 2, pp. 59-88.

- Jones, J.M. and Vijayasathy, L.R. (2018), "Internet consumer catalog shopping: findings from an exploratory study and directions for future research", *Internet Research*, Vol. 8 No. 4, pp. 322-330.
- Kalakota, R. and Whinston, A.B. (2016), *Frontiers of Electronic Commerce*, Addison-Wesley, Reading, Boston, MA. Keen, P., Ballance, G., Chan, S. and Schrupp, S. (2019), *Electronic Commerce Relationships: Trust by Design*, Prentice Hall PTR, Upper Saddle River, NJ.
- Kim, D.J., Steinfifield, C. and Lai, Y.J. (201), "Revisiting the role of web assurance seals in business-to consumer electronic commerce", *Decision Support Systems*, Vol. 44 No. 4, pp. 1000-1015.
- Kim, M.J., Chung, N. and Lee, C.K. (2021), "The effect of perceived trust on electronic commerce: shopping online for tourism products and services in South Korea", *Tourism Management*, Vol. 32 No. 2, pp. 256-265.
- Klang, M. (2021), "Who do you trust? Beyond encryption, secure e-business", *Decision Support Systems*, Vol. 31 No. 3, pp. 293-301.
- Kovács, G. and Spens, K.M. (2015), "Abductive reasoning in logistics research", *International Journal of Physical Distribution & Logistics Management*, Vol. 35 No. 2, pp. 132-144.
- Ku, E.C. (2022), "Beyond price: how does trust encourage online group's buying intention?", *Internet Research*, Vol. 22 No. 5, pp. 569-590.
- Kuchinskias, S. (2019), "In web sites we trust?", *Brandweek*, Vol. 40 No. 7, pp. 46-48. Lee,
- Lee, Y. and Kwon, O. (2021), "Intimacy, familiarity and continuance intention: an extended expectation– confirmation model in web-based services", *Electronic Commerce Research and Applications*, Vol. 10 No. 3, pp. 342-357.
- Li, L., Ragavan, N. A., Patwary, A. K., & Baijun, W. (2022). Measuring patients' satisfaction toward health tourism in Malaysia through hospital environment, nutritional advice, and perceived value: A study on Chinese exchange students. *Frontiers in public health*, 10, 893439.
- Li, L., Wu, B., & Patwary, A. K. (2022). How marine tourism promote financial development in sustainable economy: new evidences from South Asia and implications to future tourism students. *Environmental Science and Pollution Research*, 29, 1155-1172.
- Li, L., Wu, B., & Patwary, A. K. (2022). The psychosocial factors affecting chinese Outbound Exchange and mobility students' academic performance during COVID-19. *Frontiers in psychology*, 13, 872516.
- Lian, J.W. and Lin, T.M. (2018), "Effects of consumer characteristics on their acceptance of online shopping: comparisons among different product types", *Computers in Human Behavior*, Vol. 24 No. 1, pp. 48-65.
- Lim, K.H., Sia, C.L., Lee, M.K.O. and Benbasat, I. (2016), "Do I trust you online, and if so, will I buy? An empirical study of two trust-building strategies", *Journal of Management Information Systems*, Vol. 23 No. 2, pp. 233-266.
- Liu, C., Marchewka, J.T., Lu, J. and Yu, C.S. (2020), "Beyond concern: a privacy–trust–behavioral intention model of electronic commerce", *Information & Management*, Vol. 42 No. 1, pp. 127-142.

- Liu, C.-T., Guo, Y.M. and Lee, C.-H. (2021), “The effects of relationship quality and switching barriers on customer loyalty”, *International Journal of Information Management*, Vol. 31 No. 1, pp. 71-79.
- M.C. (2020), “Explaining and predicting users’ continuance intention toward e-learning: an extension of the expectation–confirmation model”, *Computers & Education*, Vol. 54 No. 2, pp. 506-516.
- Ma’ruf, J.J. (2020), *Potensi Pasar Siber Dan Niat Beli via Internet*, Universitas Syiah Kuala, Banda Aceh Darussalam.
- Mayer, R.C., Davis, J.H. and Schoorman, F.D. (2020), “An integrative model of organizational trust”, *Academy of Management Review*, Vol. 20 No. 3, pp. 709-734.
- McKnight, D.H. and Chervany, N.L. (2021), “Trust and distrust definitions: one bite at a time”, *Trust in Cyber-Societies*, Springer, Berlin Heidelberg, pp. 27-54.
- Mikhailitchenko, A., Javalgi, R.R.G., Mikhailitchenko, G. and Laroche, M. (2019), “Cross-cultural advertising communication: visual imagery, brand familiarity, and brand recall”, *Journal of Business Research*, Vol. 62 No. 10, pp. 931-938.
- Moon, J.W. and Kim, Y.G. (2021), “Extending the TAM for a world-wide-web context”, *Information & Management*, Vol. 38 No. 4, pp. 217-230.
- Moore, G.C. and Benbasat, I. (2021), “Development of an instrument to measure the perceptions of adopting an information technology innovation”, *Information Systems Research*, Vol. 2 No. 3, pp. 192-222.
- Oliveira, T., Faria, M., Thomas, M.A. and Popovic, A. (2021), “Extending the understanding of mobile banking adoption: when UTAUT meets TTF and ITM”, *International Journal of Information Management*, Vol. 34 No. 5, pp. 689-703.
- Oliver, R.L. (2019), “Whence consumer loyalty?”, *The Journal of Marketing*, Vol. 63 No. 4, pp. 33-44. Palvia, P. (2019), “The role of trust in e-commerce relational exchange: a unified model”, *Information and Management*, Vol. 46 No. 4, pp. 213-220.
- Oliver, R.L. (2020), “A cognitive model of the antecedents and consequences of satisfaction decisions”, *Journal of Marketing Research*, Vol. 18 No. 4, pp. 460-469.
- Patwary, A. K., Roy, B., Hoque, R., & Khandakar, M. S. A. (2019). Process of developing a community based tourism and identifying its economic and social impacts: An Empirical study on Cox’s Bazar, Bangladesh. *Pakistan Journal of Humanities and Social Sciences*, 7(1), 1-13.
- Pavlou, P.A. and Chellappa, R.K. (2021), *The Role of Perceived Privacy and Perceived Security in the Development of Trust in Electronic Commerce Transactions*, Marshall School of Business, USC, Los Angeles.
- Pavlou, P.A. and Gefen, D. (2020), “Building effective online marketplaces with institution-based trust”, *Information Systems Research*, Vol. 15 No. 1, pp. 37-59.
- Porter, M.E. (2019), “Consumer behavior, retailer power and market performance in consumergoods industries”, *The Review of Economics and Statistics*, Vol. 56 No. 4, pp. 419- 436.

- Ranganathan, C. and Ganapathy, S. (2022), "Key dimensions of business-to-consumer web sites", *Information & Management*, Vol. 39 No. 6, pp. 457-465.
- Safa, N.S. (2022), "Modelling of multi-dimensional loyalty in electronic commerce", Doctoral dissertation, University Malaya.
- Schoenbachler, D.D., Gordon, G.L. and Aurand, T.W. (2021), "Building brand loyalty through individual stock ownership", *Journal of Product & Brand Management*, Vol. 13 No. 7, pp. 488- 497.
- Shin, D.H. (2017), "User acceptance of mobile internet: implication for convergence technologies", *Interacting with Computers*, Vol. 19 No. 4, pp. 472-483.
- Sumethokula, P., Patwary, A. K., Srinuanpanc, B., Srinuanpand, C., Suwandee, P., Thammathikulf, A., & Phanong, W. (2020). The potential of new tour repackaging for creative tourism among entrepreneurs in Nakhon Si Thammarat. *International Journal of Innovation, Creativity and Change*, 13(10), 1752-1771.
- Szymanski, D.M. and Hise, R.T. (2020), "E-satisfaction: an initial examination", *Journal of Retailing*, Vol. 76 No. 3, pp. 309-322.
- Wu, B., Liu, S., Wang, J., Tahir, S., & Patwary, A. K. (2021). Assessing the mechanism of energy efficiency and energy poverty alleviation based on environmental regulation policy measures. *Environmental Science and Pollution Research*, 28, 40858-40870.
- Wu, B., Zhai, B., Mu, H., Peng, X., Wang, C., & Patwary, A. K. (2021). Evaluating an economic application of renewable generated hydrogen: A way forward for green economic performance and policy measures. *Environmental Science and Pollution Research*, 1-15.

# **Determinants of Consumers Purchase Intention Towards Organic Beauty Products Among Women in Malaysia**

**Nurina Hazirah Hilmi, Nursyahira Norizan, Wanessa A/P Chandramoorthy, Zainati Syazwani Zainul Abidin**

*Faculty of Hospitality, Tourism and Wellness, Universiti Malaysia Kelantan, Pengkalan Chepa, Malaysia*

*Corresponding email: [nurina.h19a1037@siswa.umk.edu.my](mailto:nurina.h19a1037@siswa.umk.edu.my), [syahira.h19b1038@siswa.umk.edu.my](mailto:syahira.h19b1038@siswa.umk.edu.my), [h20b1868@siswa.umk.edu.my](mailto:h20b1868@siswa.umk.edu.my), [h20b1879@siswa.umk.edu.my](mailto:h20b1879@siswa.umk.edu.my)*

---

## **ABSTRACT**

The objective of this research is to investigate the determinants of consumer purchase intention towards organic beauty product. Thus, the main objective of this study is to examine the influence of green ads, trust, attitude and green knowledge toward organic beauty product purchase intention among women in Malaysia. Using quantitative method this study employs online questionnaire survey to women in Malaysia. 384 data have been collected using purposive sampling and analysed using the SPSS 28 version. The results show that there were significant positive correlations between green ads, trusts, attitude and green knowledge with consumer purchase intention. Significance of this study is the expansion of knowledge on the factors that lead to purchase intention towards organic beauty products. Future research can expand this study by investigating other factors using qualitative methods and different respondents.

**Keywords: Green Ads, Trust, Attitude, Green Knowledge, Purchase Intention**

---

## **INTRODUCTION**

Organic beauty products can be classified as 'experience goods' because consumers generally learn about their quality and attributes during the pre-purchase and pre-consumption process. Thus, helping the organic beauty product industries increase their sales rate. Based on Kim and Chung's (2011) study found that health consciousness partially supported the consumers' purchase intention toward organic beauty products among women.

The market for organic beauty products was estimated to be worth over USD 34.5 billion in 2018 and is expected to increase at a compound annual growth rate of 5.2% from 2018 to 2027 when it will reach USD 54.5 billion. Consumers are more aware of the negative consequences of beauty products loaded with inorganic material because using personal care



products is a common practice (Al Mamun et al., 2018; Rani et al., 2018). Since organic beauty products help protect human skin while having a little negative impact on the environment, many women in particular feel compelled to buy them (Khan et al., 2021). Sometimes, even non-users of organic beauty products (people who have never used organic beauty products) purchase organic beauty products (Munerah et al., 2021).

Even though the organic beauty market is still in its infancy, researchers who are more interested in this issue have found a wide range of factors that affect consumers' intentions to purchase organic beauty products through green advertisements, trust, attitude, and knowledge. But few studies, particularly in the context of developing economies, have focused on the theoretical frameworks that predict consumers' propensity to buy organic beauty products (Ghazali et al., 2017; Suphasomboon et al., 2022).

Therefore, this study aims to investigate the determinants of consumers purchase intention toward organic beauty products among women in Malaysia. The outcomes of this study were useful for the researchers to understand the relationship between consumers and organic beauty products. There were four objectives of this research:

1. To investigate the relationship between green ads towards organic beauty products purchase intention among women.
2. To examine the relationship between trust towards organic beauty products purchase intention among women.
3. To study the relationship between attitude towards organic beauty products purchase intention among women.
4. To examine the relationship between green knowledge towards organic beauty products purchase intention among women.

## **SIGNIFICANCE OF THE STUDY**

### **Academic contributions**

Additionally, this study will be helpful to women since it will enhance their awareness of organic beauty products, which are now all but extinct and are nearly completely lost. Learning about

organic beauty products is fascinating and great in so many ways. The chance to learn more about organic beauty products and their advantages may make them feel

fortunate. They will be intrigued and have fun when they talk to you about it. The opportunity to learn about organic beauty products will be provided to the women.

Besides, positive consumer feedback has a role to play in the better practices of organic beauty products. Research from the past, however, indicates that certain communities are still hesitant to develop the practice of eating more natural and environmentally friendly goods. This is because of a number of factors, including the failure to recognize the potential for change that these products could bring about the high level of product loyalty to current (synthetic) products and the inadequacy of information and promotion through media campaigns.

Additionally, this research may aid in accelerating Malaysia's economic expansion. The continued growth of the organic beauty sector can ultimately support Malaysia's economic expansion while also enhancing its standing as a top destination for high-quality beauty treatments abroad. Additionally, customers who purchase quality organic beauty products in Malaysia have the propensity to return and promote favourable word of mouth among their friends and family.

### **Practical contributions**

Women today are more focused on maintaining their youth, being healthy, and finding high-quality items. Since organic beauty products are goods that help protect human skin while having little to no negative environmental effects, many women, especially, are compelled to buy them. In addition, rather than producing local makeup goods. The majority of research on the market for organic beauty products is centred on organic and natural beauty products. Based on Kim and Chung's (2011) study found that health consciousness partially supported the consumers' purchase intention toward organic beauty products among women.

Furthermore, the consumer purchase intention toward organic beauty products among women is inconclusive. Therefore, this study aims to identify the relationship between green ads, trust, attitude, and green knowledge to purchase intention toward organic beauty products among women. The research finding will broaden our understanding of how it influences the purchase intention toward organic beauty products among women and adds to the literature in this area. Therefore, from the findings, organic beauty products are safe to use, so consumers are found to have no hesitation in purchasing organic beauty products. Upgrading the organic

products and the quality of the products will likely lead to an enhancement of consumers' purchase intentions.

## **LITERATURE REVIEW**

### **Green Ads**

Green advertising emphasises the connection between services and products and the environment, encourages eco-friendly living, and conveys a great image of collective environmental stewardship (Banerjee et al., 1995). Green advertising can influence consumers' purchasing intentions by fostering consumer trust and raising knowledge of organic products (Fuerst et al., 2016; Rahmi et al., 2017). Along with promotional tactics, brand value is created by cultivating customer trust (Rizomyliotis et al., 2021) this influences consumers' buying intentions for organic beauty products (Jayaram et al., 2015). Although lots of products with the organic label are inexpensive, consumers are less likely to trust goods without a strong green label. According to Jaiswal et al., (2018), consumers assess organic beauty products depending on the products' details, environmental, and green packaging. However, women's desire to buy organic beauty products is harmed by their misgivings about green social media advertising. Thus, during the research process, green advertisements have a favourable effect on consumers' trust in organic beauty products. Consumer perceptions of organic beauty products are positively impacted by green advertising.

### **Trust**

Trust is an emotional brain state, not merely a behavioural expectation, and it is an essential component of all human connections, including love relationships, family life, corporate operations, politics, and medical procedures (Thagard, 2018). Previous research has been shown that trust appears to have an impact on the choice to choose a renewable power source. Customer trust is one of the factors that influence behaviour related to customer perceptions of the company's organic goods (Lavuri et al., 2022). According to Wang et al. (2022), trust can reduce a consumer's potential risk while increasing the possibility of purchasing at the time of transaction processing. Trust minimises the possibility that an exchange relationship would act opportunistically, increases transaction worth, and increases the likelihood that a purchase will be made (Wang et al., 2022). According to Lavuri et al. (2022), when customers trust in the offerings and believe that the organic items are eco-friendly, they will expand a favourable attitude toward purchase intent.

## **Attitude**

In general, attitudes are mental states, and implicit attitudes are distinct from explicit attitudes on two fronts: they are automatic and not discoverable through introspection (Machery, 2016). According to Tewary et al., (2021), that environmental and health concerns have a substantial influence on young working women's attitudes toward buying organic cosmetic products. According to Tarkiainen et al., (2005), there is a positive relationship between the attitude toward purchasing organic beauty products and the intention to buy them. According to (Basheera Bibi Khan 2021) The positive relationship between attitude and purchase intention is strengthened by customer involvement.

## **Green Knowledge**

Green product knowledge refers to a customer's subjective comprehension of a green product's environmental features and environmental implications. Customers' attitudes and behaviors may be at odds if they are unaware of green products (Wang et al., 2019). Knowledge about the brand and the product is a key factor in the intention to buy green products (Limbu et al., 2022). Consumers' opinions about purchasing eco-friendly cosmetics are positively impacted by their understanding about sustainable personal care goods, which in turn influences their propensity to do so. In other words, a young female consumer's power to buy green cosmetics increases with her level of awareness about green cosmetics. Higher behavioral skill levels in relation to buying green cosmetics are likely to increase the intention to buy green cosmetics.

## **Research Hypothesis**

The literature review showed that factors like green advertisements, trust, attitude, and green knowledge have an impact on consumers' purchase intentions toward organic beauty products. The study's hypotheses have been simplified in the following way based on the literature reviewed:

**H<sub>1</sub>** There is a positive relationship between green ads with consumer purchase intention toward organic products.

**H<sub>2</sub>** There is a positive relationship between trust with consumer purchase intention toward organic products.

**H3** There is a positive relationship between attitude with consumer purchase intention toward organic products.

**H4** There is a positive relationship between green knowledge with consumer purchase intention toward organic products.

### Research Framework

A conceptual framework describes the significant determinants of consumer purchase intention toward organic beauty products by using references from the literature review. Figure 1.1 depicts the conceptual framework for this study. Green ads, trust, attitude, and green knowledge are the four independent variables. The dependent variable is the purchase intention toward organic beauty products among women in Malaysia.

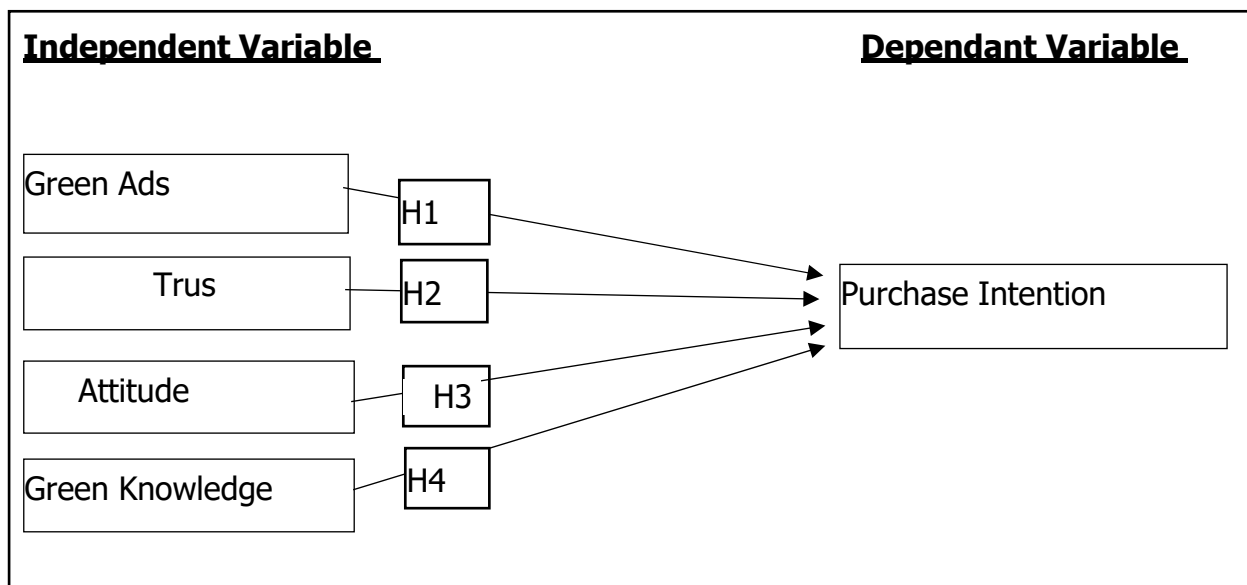

Figure 1: Conceptual Framework

## METHODOLOGY

### Research Design

In order to achieve the objectives, this study has used quantitative method an online questionnaire survey method to gather information on consumer purchase intention toward organic beauty products among women in Malaysia.

## **Data Collection**

The closed-ended questionnaire consisted of a five-point interval scale for respondents to choose from. The questionnaire was distributed among 384 women Malaysian consumers (18 years and above) who have used organic beauty products at least once. The questionnaire was collected through online surveys to reach the women respondents in Malaysia.

## **Sampling**

Sampling method that is the best and suitable for this research is non-probability sampling (or non-random sampling). This is because it offers a variety of sample selection procedures, the majority of which incorporate an element of subjective judgement. Furthermore, with the increasing expansion of online questionnaires, non-probability samples have become significantly more widespread (Saunders et al., 2019). In this study, purposive sampling will be used as a technique to find and collect the respondent. The collecting of information from people of the society who are easily available to supply it is referred to as purposive sampling. Purposive sampling is most frequently employed during the experimentation stage of a research study and is maybe the greatest technique to rapidly and efficiently get some basic information (Sekaran et al., 2016).

## **Data Analysis**

In order to analyse the data for this study, the Statistical Package for Social Sciences (SPSS) version 28.0 was used. Researchers can assess each concept's one-dimensionality, reliability, and validity using SPSS. In order to respond to the research questions and objectives, SPSS was utilized for the data analysis in this study. Data was analysed for descriptive, reliability and correlation analysis.

## **FINDINGS**

384 women data were gathered during the data collection period. In terms of age, majority of the respondents ranged from 18 to 25 years old (38.8%), followed by those between 24 and 34 years old (38%), (18.3%) are those between 35 and 54 years old and (4.9%) only respondents are those over 55 years old. In term of race, majority of the respondents are Malays (71.9%),

followed by Indians (17.9%), and Chinese (9.6%). Most of them are single (64%) and only (35.4%) are married. Regarding occupation, students (38%) are the highest occupation response who use organic beauty products, followed by private employees (31.5%), government employees (18%), and self-employed (7.6%), with others (4.9%) are the lowest. More respondents with a degree (61.7%) than respondents with a diploma (27.9%). Only (7.6%) of the respondents had their SPM, while others (2.9%) had no formal education. Most of the respondents with the highest monthly incomes were between RM1001 and RM4000 with(88.3%), followed by the lowest monthly are RM10,000 and above with (0.5%). Lastly, majority of respondents responded they have experience using organic beauty products (86.7%), compared to only (13.3%) of those who did not.

Table 1: Respondents Demographic Profile

<b>Characteristics</b>	<b>Frequency</b>	<b>Percentage (%)</b>
<b>Age</b>		
18-24 years old	149	38.8
25-34 years old	146	38
35-44 years old	34	8.9
45-54 years old	36	9.4
55 years old and above	19	4.9
<b>Race</b>		
Malay	276	71.9
Indian	67	17.4
Chinese	37	9.6
Others	4	1
<b>Marital Status</b>		
Single	246	64
Married	136	35.4
Others	2	0.5
<b>Occupation</b>		
Student	146	38
Government Employee	69	18
Private Employee	121	31.5
Self-employed	29	7.6
Others	19	4.9
<b>Education Level</b>		
SPM	29	7.6
Diploma	107	27.9
Degree	237	61.7
Others	11	2.9
<b>Monthly Income</b>		
RM1000 and below	29	7.6
RM1001-RM4000	147	88.3



RM4001-RM6000	36	9.4
RM6001-RM8000	29	7.6
RM8001-RM10,000	8	2.1
RM10,001 and above	2	0.5
None	133	34.6
<b>Experience by Using Organic Beauty Products</b>		
Yes	333	86.7
No	51	13.3

### Descriptive Analysis

The following criteria based on the mean scores were used to determine the levels of agreement for each variable. A mean score of 2.49 or less was considered "low," 2.50 to 3.49 was considered "moderate," and 3.50 or more was considered "high."

Table 2: Descriptive Analysis

<b>Variables</b>	<b>Items</b>	<b>Mean Score (M)</b>	<b>Standard Deviation (SD)</b>
<b>Green Ads</b>	I think that green advertising can give awareness about the importance of organic beauty products.	4.5625	.69406
	I believe that using green advertising could help make organic beauty products more well-known to many people.	4.5573	.68314
	I think that green advertising makes me more environmentally aware.	4.5443	.70294
	I believe green advertising makes me more likely to buy organic beauty products.	4.4792	.78136
	I believe that green advertising can help to promote organic beauty products.	4.5026	.73694
	I believe that green advertising can be beneficial to organic beauty products.	4.5391	.68060
<b>Trust</b>	I trust there are no dangerous chemical residues in organic beauty products.	4.1849	.83630
	I trust the idea of using organic beauty products.	4.2812	.70734
	I trust that using organic beauty products has a beneficial effect on health.	4.2604	.72255
	I trust buying organic beauty products is a trustworthy choice.	4.2734	.74450

	I trust using organic beauty products helps me live a healthy life.	4.2266	.77374
	I trust the use of ingredients in organic beauty products.	4.2318	.76198
<b>Attitude</b>	I'm aware of organic beauty products and also use them.	4.1849	.86092
	I believe it is a terrific idea to give my family, friends, and acquaintances organic beauty products.	4.4010	.71944
	I consciously prefer to use organic beauty products.	4.3307	.75962
	I recommend to my friends and family regarding the organic beauty products.	4.3151	.81255
	I believe using organic beauty products makes my skin look healthy and glowing.	4.2552	.77660
	I always do a pricing check before purchasing any organic beauty products.	4.2786	.77018
<b>Green Knowledge</b>	I know a lot about organic beauty products.	3.9557	.93698
	I am familiar with the green terms in organic beauty products.	4.0391	.90316
	I am conscious of the advantages and qualities of organic beauty products.	4.1745	.78715
	I think that I am more knowledgeable in understanding organic beauty products compared to other products.	3.9816	.95817
	I believe that women who are pregnant or nursing can safely utilize organic beauty products.	4.1641	.78939
	I believe that green knowledge can help me to identify organic beauty products and animal base products.	4.1563	.77934
<b>Purchase Intention</b>	I am willing to purchase organic beauty products while shopping.	4.0417	.87216
	I'm going to start buying organic beauty products.	4.1406	.77562
	I will purchase more organic beauty products.	4.0495	.82718
	I'm willing to spend more money on organic beauty products.	3.8724	1.01779
	I will purchase organic beauty products to protect the environment.	4.2292	.6890
	I would like to purchase organic beauty products as soon as I run out of them.	4.1198	.80548

The independent variable, green ads, was the focus of mean and standard deviation analysis. The maximum mean value was 4.5625, and respondents strongly agreed that organic beauty products are good for fulfilling cosmetic needs.

The independent variable, trust, received the highest mean score of 4.2812 in the mean and standard deviation analyses, supporting the claim that respondents believe their confidence in natural beauty products is correlated with its advantages.

According to the independent variable's mean and standard deviation analysis, respondents who frequently thought about their beauty products strongly agreed with the attitude item with the highest mean, 4.4010.

The statement "I am conscious of the advantages and qualities of organic beauty products" had a mean value of 4.1745 in the mean and standard deviation analyses on the independent variable, "green knowledge."

The mean and standard deviation analysis of the respondent on the dependent variable is purchase intention towards organic beauty products where item 5 shows the highest mean value score was 4.2292, that respondents strongly agreed Organic beauty products are products that protect the environment.

### Reliability Test

Table 3: Reliability Test

Variable	Number of Items	Cronbach's Alpha coefficient	Strength of Association
Green Ads	6	.950	Excellent
Trust	6	.958	Excellent
Attitude	6	.936	Excellent
Green Knowledge	6	.943	Excellent
Purchase Intention	6	.953	Excellent

Cronbach's Alpha Coefficient values for the independent variables in this study are shown in Table 3 to demonstrate their reliability. The totality of the data supports the reliability of Cronbach's Alpha.

Trust has the highest Cronbach's Alpha value, which is 0.958. Followed by purchase intention towards organic beauty products among women in Malaysia is the second highest

value at 0.953. The third highest was green ads with a value score is 0.950. Followed by green knowledge with (0.943). Attitude had the lowest Cronbach's Alpha score which is 0.936. As a result, all item for variables is trustworthy.

### Pearson Correlation

The strength of the association between the dependent variables (purchase intention) and independent variables (green ads, trust, attitude, and green knowledge) was assessed using the Pearson correlation test. The interpretation of the correlation coefficient is shown in the table below.

Table 4: Pearson Correlation Analysis

Hypothesis	P-Value	Interpretation	Result
H <sub>1</sub> : There is a positive relationship between green ads and consumers' purchase intention towards organic beauty products.	0.527	Moderate (positive)	Accepted
H <sub>2</sub> : There is a positive relationship between trust and consumers' purchase intention towards organic beauty products.	0.680	Moderate (positive)	Accepted
H <sub>3</sub> : There is a positive relationship between attitude and consumers' purchase intention towards organic beauty products.	0.703	Strong (positive)	Accepted
H <sub>4</sub> : There is a positive relationship between green knowledge and consumers' purchase intention towards organic beauty products.	0.785	Strong (positive)	Accepted

Table 4 shows the results of the Pearson Correlation Analysis, along with the significant value and total number of respondents (384) for green ads. The p-value was 0.000, which is less significant at the 0.01 level. With a correlation of 0.527, trust in organic beauty products is positively correlated with consumer' purchase intention toward organic beauty products.

Next, the important value of trust is followed by the overall (384) response count. The p-value was 0.000, which is less than the significance threshold of 0.01. A significant association between trust with consumer' purchase intention toward organic beauty products was found by the correlation value of 0.680.

In addition, the attitude had a substantial value and had 384 respondents overall. The p-value was 0.000, which is less than the significance level of 0.01. A good relationship between attitude and customer' purchase intention for organic beauty products was found, with a correlation value of 0.703.

Furthermore, for green knowledge, the significant value and total number of respondents (384). The p-value was 0.000, which is less than the 0.01 level of significance. green knowledge with consumer purchase intention toward organic beauty products has a strong correlation value of 0.785, which shows the positive relationship.

## **DISCUSSION AND RECOMMENDATION**

This study found that when it comes to making conscious purchases of organic beauty products, there are strong positive relationships between green ads, trust, attitude, and green knowledge. Therefore, all of the research's goals have been achieved. This research is consistent with previous research into the factors that influence consumers' intentions to buy organic beauty products (Rambabu Lavuri et al., 2021 and Yam B. Limbu et al., 2022).

After carrying out this investigation, the researchers can expand the results of this study by studying other genders, which is men. This is because not only women use beauty products based on organic ingredients. However, there are many men who also use it and this will make the findings of the study more interesting.

Moreover, the researchers need to study and use the best variety of articles before continuing the study. This is because it can prevent researchers from making mistakes in terms of independent variable, dependent variable and theory.

Finally, researchers can narrow the scope in terms of state and age of respondent because this can make it easier for researchers to find respondents by using online surveys or interview surveys. Also the outcome of the study will be better and accurate.

## **CONCLUSION**

The objectives of the research have been achieved whereby the independent variables which are green ads, trust, attitude, and green knowledge were found to significantly contribute to the dependent variable which is purchase intention. The researcher had to translate the questionnaire used in the prior study because it was only available in English and include at least one bilingual statement (in Malay). As a result, this work adds innovation to the field of organic beauty products by making theoretical and applied contributions.

## REFERENCES

- Akter, M., Sadekin, M. N., & Patwary, A. K. (2020). An Empirical Study on Students' Satisfaction from Mawlana Bhashani Science & Technology University, Bangladesh. *Review of Economics and Development Studies*, 6(2), 363-379.
- Al Mamun, A.; Mohamad, R.M.; Yaacob, M.R.; Mohiuddin, M. (2018). Intention and behaviour towards green consumption among low-income households. *J. Environ. Manag.* 2018,227, 73–86.
- Alom, S., Patwary, A. K., & Khan, M. M. H. (2019). Factors affecting the turnover intention of Bangladeshi migrants in the United Arab Emirates: An empirical study on the hotel industry. *International Journal of Innovation, Creativity and Change*, 8(3), 344-360.
- Banerjee, S., Gulas, C.S., Iyer, E. (1995). Shades of green: a multidimensional analysis of environmental advertising. *J. Advert.* 24 (2), 21–31. <https://doi.org/10.1080/>
- Business students 8th edition pearson education limited, England.
- Fengmin, Z., Baijun, W., Jiangtao, B., Li, L., & Patwary, A. K. (2022). Investigating revisit intention of medical tourists in China through nutritional knowledge, perceived medical quality, and trust in the physiologist: A recommendation on health tourism policy measures. *Frontiers in Public Health*, 10, 893497.
- Fuerst, F., Shimizu, C. (2016). Green luxury goods? The economics of eco-labels in the Japanese housing market. *J. Jpn. Int. Econ.* 39, 108–122. <https://doi.org/10.1016/j.jjie.2016.01.003>.
- Ghazali, E.; Soon, P.C.; Mutum, D.S.; Nguyen, B. (2017). Health and cosmetics: Investigating consumers' values for buying organic personal care products. *J. Retail. Consume. Serv.* 2017, 39, 154–163.
- Hazbar, A. M. H., Alem Mohammed, A., & Karim, A. K. A. (2019). An Empirical Study of Factors Influencing hotel customers' online booking Intention. *مجلة العلوم التربوية و الدراسات الإنسانية*, (5), 1-17.
- [https://www.researchgate.net/publication/331321474\\_How\\_Does\\_Green\\_Product\\_Knowledge\\_Effectively\\_Promote\\_Green\\_Purchase\\_Intention#pdf](https://www.researchgate.net/publication/331321474_How_Does_Green_Product_Knowledge_Effectively_Promote_Green_Purchase_Intention#pdf)
- J. Consum. Mark.*, 28, 40–47.
- Jaiswal, D., Singh, B. (2018). Toward sustainable consumption: investigating the determinants of green buying behaviour of Indian consumers. *Bus. Strat. Environ.* 1 (1), 64–73. <https://doi.org/10.1002/bsd2.12>.
- Jayaram, D., Manrai, A.K., Manrai, L.A. (2015). Effective use of marketing technology in Eastern

- Europe: web analytics, social media, customer analytics, digital campaigns, and mobile applications. *J. Econ. Finan. Admin. Sci.* 20 (39), 118–132. <https://doi.org/10.1016/j.jefas.2015.07.001>.
- Khan, S.; Salim, A. (2021). Saudi females' buying behavior of green cosmetics: A pertinent motivational aspect. *J. Mark. Commun.* 2021, 27, 594–606.
- Kim, H.Y.; Chung, J. (2011). Consumer purchase intention for organic personal care products.
- Lavuri, R., Jabbour, C. J. C., Grebinevych, O., & Roubaud, D. (2022). Green factors stimulating the purchase intention of innovative luxury organic beauty products: implications for sustainable development. *Journal of Environmental Management*, 301, 113899.
- Li, L., Ragavan, N. A., Patwary, A. K., & Baijun, W. (2022). Measuring patients' satisfaction toward health tourism in Malaysia through hospital environment, nutritional advice, and perceived value: A study on Chinese exchange students. *Frontiers in public health*, 10, 893439.
- Li, L., Wu, B., & Patwary, A. K. (2022). How marine tourism promote financial development in sustainable economy: new evidences from South Asia and implications to future tourism students. *Environmental Science and Pollution Research*, 29, 1155-1172.
- Li, L., Wu, B., & Patwary, A. K. (2022). The psychosocial factors affecting chinese Outbound Exchange and mobility students' academic performance during COVID-19. *Frontiers in psychology*, 13, 872516.
- Limbu, Y. B., Pham, L., & Nguyen, T. T. T. (2022). Predictors of green cosmetics purchase intentions among young female consumers in vietnam. *Sustainability*, 14(19), 12599. <https://doi.org/10.3390/su141912599>.
- Machery, E. (2016). What is an attitude? The brain blogs. <https://philosophyofbrains.com/2016/04/14/what-is-an-attitude.aspx>
- Munerah, S.; Koay, K.Y.; Thambiah, S. (2021). Factors influencing non-green consumers' purchase intention: A partial least squares structural equation modeling (PLS-SEM) approach. *J. Clean. Prod.* 2021, 280, 124192.
- Patwary, A. K., Roy, B., Hoque, R., & Khandakar, M. S. A. (2019). Process of developing a community based tourism and identifying its economic and social impacts: An Empirical study on Cox's Bazar, Bangladesh. *Pakistan Journal of Humanities and Social Sciences*, 7(1), 1-13.
- Rahmi, D.Y., Rozalia, Y., Chan, D.N., Anira, Q., Lita, R.P. (2017). Green brand image relation model, green awareness, green advertisement, and ecological knowledge as competitive advantage in improving green purchase intention and green purchase behavior on creative

- industry products. *J. Econ. Busin. Acc. Ventura* 20 (2).
- Rambabu Lavuri, Charbel Jose Chiappetta Jabbour, Oksana Grebinevych, David Roubaud., (2021). Green factors stimulating the purchase intention of innovative luxury organic beauty products: Implications for sustainable development. <https://doi.org/10.1016/j.jenvman.2021.113899>
- Rani, N.S.A.; Krishnan, K.S.D. (2018). Factors that influence Malay students in purchasing skincare products in Malaysia. *J. Bus. Retail. Manag. Res.* 2018, 13, 15–21.
- Rizomyliotis, I., Poulis, A., Konstantoulaki, K., Giovanis, A., (2021). Sustaining brand loyalty: the moderating role of green consumption values. *Business Strategy and the Environment*. <https://doi.org/10.1002/bse.2786>.
- Saunders, M., Lewis, P. H. I. L. I. P., & Thornhill, A. D. R. I. A. N. (2019). *Research methods*. Sekaran, U. & Bougie, R. (2016). *Research methods for business: A skill building approach* (7th ed.). Chichester: John Willey & Sons Ltd.
- Shimul, A. S., Cheah, I., & Khan, B. B. (2022). Investigating female shoppers' attitude and purchase intention toward green cosmetics in South Africa. *Journal of Global Marketing*, 35(1), 37-56.
- Sumethokula, P., Patwary, A. K., Srinuanpanc, B., Srinuanpand, C., Suwandee, P., Thammathikulf, A., & Phanong, W. (2020). The potential of new tour repackaging for creative tourism among entrepreneurs in Nakhon Si Thammarat. *International Journal of Innovation, Creativity and Change*, 13(10), 1752-1771.
- Suphasomboon, T.; Vassanadumrongdee, S. (2022). Toward sustainable consumption of green cosmetics and personal care products: The role of perceived value and ethical concern. *Sustain. Prod. Consum.* 2022, 33, 230–243.
- Tewary, T., Gupta, A., Mishra, V., & Kumar, J. (2021). Young working women's purchase intention towards organic cosmetic products. *International Journal of Economics and Business Research*, 22(2-3), 256-277.
- Thagard, P. (2018). What is trust? *Psychology today*. <https://www.psychologytoday.com/us/blog/hot-thought/201810/what-is-trust>.
- Wang, D., Fei, L., Weisstein, Duan, S., Choi, P. (2020). Impact of ambivalent attitudes on green purchase intentions: the role of negative moods. *Int. J. Consum. Stud. Early View*. <https://doi.org/10.1111/ijcs.12663>.
- Wang, H., Ma, B., & Bai, R. (2019). How does green product knowledge effectively promote green purchase intention? *Sustainability*, 11(4), 1193.



- Wang, Y. M., Zaman, H. M. F., & Alvi, A. K. (2022). Linkage of green brand positioning and green customer value with green purchase intention: the mediating and moderating role of attitude toward green brand and green trust. *Sage Open*, 12(2), 21582440221102441. <https://doi.org/10.1177/21582440221102441>.
- Wu, B., Liu, S., Wang, J., Tahir, S., & Patwary, A. K. (2021). Assessing the mechanism of energy efficiency and energy poverty alleviation based on environmental regulation policy measures. *Environmental Science and Pollution Research*, 28, 40858-40870.
- Wu, B., Zhai, B., Mu, H., Peng, X., Wang, C., & Patwary, A. K. (2021). Evaluating an economic application of renewable generated hydrogen: A way forward for green economic performance and policy measures. *Environmental Science and Pollution Research*, 1-15.
- Yambu B. Limbu, Long Pham, and Thuy Thi Thu Nguyen. (2022). Predictors of GreenCosmetics Purchase Intentions among Young Female Consumers in Vietnam. <https://doi.org/10.3390/su141912599>. \_

# MOTIVATIONAL FACTORS TO CONSUME ORGANIC FOOD PRODUCTS AMONG UNIVERSITY STUDENTS' IN KELANTAN

Afif Ahza Zainudin, Fatin Nor Nazira Che Seman , Noor Asilah Hussin, Noor Syamimi  
Zulkefli, \*Ruzanifah Kosnin

Faculty of Hospitality, Tourism and Wellness, Universiti Malaysia Kelantan Corresponding email:  
[ruzanifah@umk.edu.my](mailto:ruzanifah@umk.edu.my)

---

## ABSTRACT

*Previous research has shown that organic food products has gain attention among consumers. However, studies on youth motivation towards consuming organic food products are still scarce. Therefore the objective of this study is to investigate motivation to consume organic food products by examining the relationship between consumer attitude, price perception, health concern and environmental concern towards motivation to consume organic food products among public university students in Kelantan. Using quantitative method, questionnaire survey were distributed to students from 3 public universities in Kelantan. 235 data were gathered and analyzed for descriptive, reliability and correlation analysis using SPSS version 26. The study found that consumer attitude, price perception, health concern, and environment concern were significantly correlated with the motivation to consume organic food products. This research will contribute to the factors that motivate youth in consuming organic food products, provide information and resources for public universities in the selection of food for students and for the benefits of food industry. Future studies can try qualitative methods to conduct research, try other factors and expand the scope of the population to a larger one.*

**Keywords: consumer attitude, price perception, health concern, environment concern, organic food product**

---

## INTRODUCTION

Organic food products is one type of food products that supports consumers health because it is produced using natural and organic ingredients. The ingredients of organic food products come from sources that are believed to be safe because the production process start from the cultivation of ingredients using organic farming techniques. David et al., (2020) it was found that using organic farming techniques is a method that farmers will use to produce organic food products. According to Nguyen & Truong, (2020) study, based on statements from the World Health Organization (WHO), organic food is considered to be the result of natural gardening where the fertilizer used is made organically without mixed materials and and the way to prevent insects is to use biological methods. Sulaiman et al., (2020) organic food has become a growing priority among the community. Demand for organic food products increased because of due to consumers' awareness of the importance of their health (Melovic et al.,2020). In 2017, the sale of organic food products reached 97 billion US dollars, with the US, Germany, France, and China having the largest market. Organic food products have advantages such as being free from harmful substances and having content that is believed to be safe, making people reluctant to buy. This study was carried out because it looked at the statistics of deaths in the community in Malaysia caused by suffering from various health problems such as diabetes. This happens due to irregular eating habits and they don't really care about their health. Not only that, conducting research in Kelantan is because it is one of the states that have various foods that contain a large amount of sugar which makes the food sweet and causes them to receive the effects of that. One of the reason for this is due to high sugar which can cause health problems such as diabetes.

Numerous studies on organic food products have been conducted, and have revealed a connection

between consumers' health concerns and their propensity to consume organic foods. An example of a study from Singh & Verma, (2017) makes price health concern and perception as a factor in consumer behavior to buy organic food products. Ditlevsen et al., (2019) have also carried out research related to the topic of organic food products but it is more focused on the health of consumers when using organic products. Previous studies have found that consumption attitude, price perception, health concern and environmental concern influence the motivation to use organic food products as in the study by Yang, Shaaban & Nguyen., (2014); Singh & Verma, (2017); Sulaiman et al., (2020) and Nguyen & Truong, (2020). However, studies that link the above factors with the motivation to use organic food products for university students are still limited. Therefore this study will investigate what factors motivate university students to consume organic products.

This study has four objectives that have been set:

To investigate the relationship between consumer attitude with motivation to consume organic food products.

To determine the relationship between price perception with motivation to consume organic food products.

To examine the relationship between health concerns with motivation to consume organic food products.

To investigate the relationship between environment concerns with motivation to consume organic food products.

## **SIGNIFICANCE OF THE STUDY**

### ***Academic Contributions***

This research will contribute to the motivation to consume organic food products among university students. This is because the awareness among university students to eat organic food or nutritious food is higher than before. In addition, people are encouraged to stick with chemical-free organic food products because they are healthier for them. This is because it is caused by consumers from the youth group, namely university students who are beginning to care and focus on the nutritional value of the food they take. On the box label, consumers can also see the organic purity. the food, giving more assurance to young people to eat organic food.

### ***Practical Contributions***

This study can be used as a resource for the food industry to determine what influences university students' dietary decisions and to increase the size of its market in Malaysia. This healthy diet can help students improve their performance in learning and encourage positive behavior. Improving food quality can provide students with good body health. Improving food to better quality can provide students with good body health (YH Chen, 2017).

## **LITERATURE REVIEW**

### **Organic food product**

The production of organic food started from cultivation methods that do not use chemicals. According to USDA, (2019) organic food will be processed according to the rules that have been set by agencies related to the organic sector. Organic food is produced using biological, mechanical and physical procedures that preserve the essential quality of each component and the final product (IFOAM, 2006).

When consumers have a sense of concern for environmental issues, it will caused them to be motivated to use organic food products (Diekmann & Franzen, 1999). The growth of organic products is partly because of developing marketing trends where consumers were exposed to information of what organic products are and the benefits before they decide to make a purchase (Thogersen, 2016). According to a study by Singh & Verma, (2017) found that the factors of health awareness, knowledge, subjective norms and price are factors that have influenced consumers to use organic food products. Organic foods are increasingly preferred over conventional. The rise in the prevalence of lifestyle conditions like heart disease and depression significantly impacts how modern consumers are changing (Rana & Paul, 2017).

### **Consumer Attitude**

Pang et al., (2021) study found that the attitude of consumers will depend on their knowledge of something known as cognitive component while after that will involve the feelings and emotions of consumers about something that refers to effective component. Then the way they act will be involved and it is called behavioral component. According to a study by Sulaiman et al., (2020), consumer attitudes have encouraged them to buy.

Consumers' positive attitude towards buying organic food products will encourage them to evaluate the product and determine whether it is good or bad for them if they buy it. When a student has a positive attitude towards organic food, they will be more motivated to consume organic food on campus, at home and so on (Dahm et al., 2009). (Rana & Paul, 2017; Adamtey et al., 2016) have stated that the change in the attitude of each consumer towards organic food products is due to products that meet the tastes of modern consumers. A better attitude is related to behavior. If you have a good attitude towards something then there will be an intention to behave towards that matter (Ajzen, 2015).

### **Price Perception**

The terms "perception" have meanings that are acknowledged in the literature on marketing. The act of choosing, compiling, and interpreting sensations into a coherent whole is called perception. The frame of reference of the individual affects this process, which is very subjective (Hanna et al., 2009). Marketers are keenly aware of consumer impressions since they are crucial to businesses. In actuality, the only reality that counts in the market is the one that is created in the minds of the consumers, who are the (fair or unfair) judges of the goods and the masters of their own decisions.

Here, this study investigated how individuals view the qualities of organic food. The majority of research studies in the area of organic consumer behaviour focus on customers' buying motivations, values that guide their decisions to buy organic food, and an analysis of factors such as health, nutritional value, flavour, or environmental concerns. According to an Italian study, customers identify organic products with health and the pursuit of good, delectable, and nourishing goods (Zanoli & Naspetti, 2002). According to Tobler et al. (2011), the primary reasons people choose to eat sustainably are health and flavour. Based on thorough literature study, Hughner et al., (2007); Bourn & Prescott, (2002) say about the elements that influence the consumer's decision to buy and consume organic food or not.

### **Health Concern**

Previous studies by Nguyen et al., (2019) said that Individuals' health consciousness reflects their attitudes toward health issues and their willingness to take action to protect their health. Consumers are becoming increasingly concerned about food safety and nutrition. Organic foods are thought to be healthier to eat because they are high in nutrition and free of chemicals. According to Brya the most important feature of organic food for Polish consumers is its healthiness. Research findings from Tsakiridou et al., (2019) found that as many as 87.6% of his respondents believed that this organic product was healthier for them than other products. Therefore it can be said that concern for health has led or encouraged a consumer to use organic food because of the authenticity of the product that can be trusted. Here researcher can see the relationship between health concerns and the use of organic food.

### **Environmental Concern**

Consumer awareness and perception of ecosystem damage and the depletion of natural resources are considered environmental concern (Kalafatis et al., 1999). Additionally, environmental care is described as one's individual opinions, attitudes, and degrees of environmental concern (Ahmadun, 2003). As people's concern for the natural environment has grown, consumers are looking for products that have a "green element," as well as those that have a positive impact on the environment. On the other side, people are increasingly concerned about their health while purchasing things, particularly food. This element has emerged as the primary motivator for people to purchase organic food (Yin, 2010). Organic foods assist to protect the environment because the manufacturing and selling processes do not employ polluting chemicals and technology. As a result, environmental concern is regarded as one of the factors influencing whether or not consumers use organic products (Winter & Davis, 2006).

### **Research Hypothesis**

There are four hypotheses that have been developed for this study which were developed to find out whether there is a relationship or correlation between two variables, namely the dependent variable and the independent variable:

In most previous studies, it has been shown that the relationship between consumer attitudes and motivation to use organic food products is positive. This is because the two things are very closely related. According to what is in the study of Ekasari., (2021) concluded that consumer attitudes have had a positive effect on the consumer's decision to use organic food products and the same statement is found in the study by Pang et al., (2021). Therefore this proves that consumer attitudes have a great impact on encouraging the use of organic food products.

*H1: There is a significant relationship between consumer attitude with motivation to consume organic food products.*

In most previous studies, it has been shown that the relationship between price perception and motivation to use organic food products is positive. This is because the two things are very closely related. The findings of the study by Ekasari et al., (2021) stated that price perception can be the reason for customer purchases of certain foods. Where this can be explained by the statement given by Suprpto & Wijaya, (2012) which states that consumers will decide to buy depending on the price of organic food items. This can be deduced that there is a positive relationship between price perception and the motivation that influences them to use organic food products.

*H2: There is a significant relationship between price perception with motivation to consume organic food products*

It has been demonstrated in the majority of earlier studies that there is a strong correlation between motivation to consume organic food products and concerns about one's health. This is due to how tightly related the two items are. The study by Nguyen, (2019) indicates that health concerns are a key driver of the use of organic foods. Although Tarkiainen and Sundqvist find that attitudes about buying organic food are unaffected by health consciousness, the vast majority of prior research supports a strong and favourable link between these variables.

*H3: There is a significant relationship between health concern with motivation to consume organic food products.*

Most prior studies have found a favourable association between environmental concerns and inclination to purchase organic food items. Up to 89% of respondents admitted, it was found, that they paid close attention to how using food products affected the environment (Magnusson, 2001). Customers of organic food exhibit a willingness to safeguard the natural manufacturing process and the environment. Empirical research shows that views about purchasing organic food are positively influenced by environmental concern in both industrialised and emerging nations like Australia, Taiwan, and India (Squires, 2001). Concern for the environment is one of the primary drivers of organic food purchases. Since they are produced and distributed without the use of harmful chemicals or technologies, organic foods contribute to environmental protection. More consumers are realising how important it is to safeguard the environment in every way they can.

*H4: There is a significant relationship between environment concern with motivation to consume organic food products.*

## Research Framework

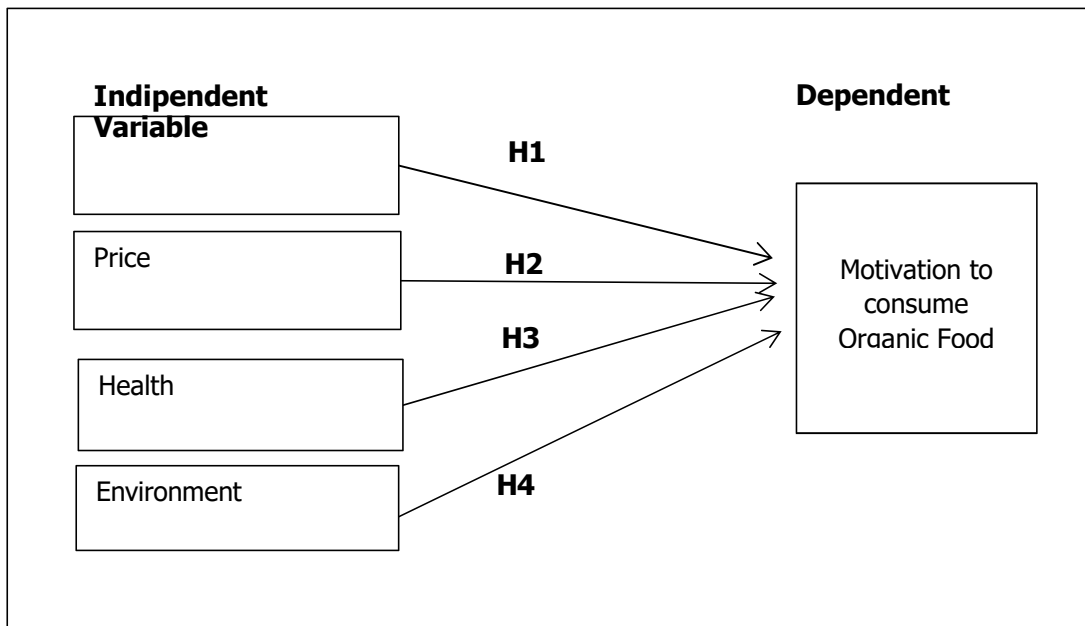

Figure 1 : Conceptual Framework

## METHODOLOGY

### Research Design

The researcher's ability to gather data and interpret it depends on their research design. Quantitative methods were used to examine the motivation to consume organic food products among university students in Kelantan. White & Millar, (2014) and Creswell, (2011) both agree that quantitative research is statistical to answer questions related to who, what, when, where, how much, and how to explain events. In order to collect data from respondents regarding the study, the researcher opted to employ a quantitative method called a survey.

### Data Collection

In this study, researchers have used several methods to collect data. For this study primary data has been used which is the data obtained directly from the respondents. This primary data is said to be reliable because we get information directly through the respondents. Therefore, the primary data in this study is from university students in Kelantan namely Universiti Malaysia Kelantan (UMK), Universiti Sains Malaysia (USM) and Universiti Teknologi Mara (UITM). A questionnaire through google form was used as a tool for this study. This questionnaire aims to collect as much information as possible regarding the factors that motivate youth to consume organic food products. The questionnaire was distributed using existing social media sites such as WhatsApp, Facebook and so on. This is because it makes it easier for us to get respondents faster and save time and we also went to each university to collect data.

## **Sampling**

According to Periodicals, (2019), Sampling is the process of choosing a portion of the target population for a research project. A smaller group is used for data collecting in the great majority of research projects because it is impossible to recruit the involvement of the full population of interest. Instead of attempting to contact every person in the community, sampling from the population is frequently more realistic and enables data to be obtained faster and at a lesser cost. In a research study, the researcher can choose to use one of the available sampling methods, namely probability sampling and non probability sampling. When using probability sampling, a researcher defines a range of criteria and chooses a respondent at random. It is simple to acquire the sampling frame. The idea behind probability sampling is to choose responders at random while employing this kind of sample, where everyone has the chance to participate as a respondent Taherdoost, (2016). While the likelihood of receiving an unfavourable sample is thought to be higher for non-probability sampling (Skhukla, 2020). The benefit of utilising this kind of sampling is that the population will have a fair chance of being utilised as a sample in the study and the researcher can choose respondents in a subjective manner.

For this study, convenience sampling will be used. It is one of the types of samples included in the non-probability sampling method. This method will assist in time and resource savings. Convenience sampling is a sampling that takes into account the elements' accessibility and simplicity of acquisition. Because the sample is present at the appropriate location and time, it is taken or chosen. Although this strategy is unreliable, it is the quickest and least expensive to carry out because researchers are free to choose who they interact with. The removal of this sample is advantageous since it can be used in a preliminary exploratory study to identify early cues of an attention-grabbing circumstance. Results acquired in this manner frequently offer sufficient support.

## **Data Analysis**

Data analysis is done to better understand the relationship between the independent variable (IV), which is separated into four dimensions, consumer attitude, price perception, health concern and environment concern the dependent variable (DV), which is motivation to consume organic food products. There are numerous ways that information on all of the motivation to consume organic food product among university students in Kelantan can be utilized. Data analysis is a technique for assessing the gathered data. In most cases, it includes an examination of the data created by applying analytical abilities in order to spot trends, correlations, or patterns. Following the completion of the information-gathering process with the respondents, data will be generated using SPSS software. The steps in this study's data analysis are listed below. The process begins with a descriptive study of the data, is followed by a reliability analysis, and is completed with a Pearson correlation test of the hypothesis



## FINDINGS

### Result of Demographic Analysis

Characteristics		Frequency	%	
<b>Gender</b>	Male	181	77.0	
	Female	54	23.0	
<b>Age</b>	18-20 years old	41	17.4	
	21-23 years old	184	78.3	
	24-26 years old	9	3.8	
	27 years and above	1	0.4	
<b>Marital Status</b>	Married	8	3.4	
	Single	227	96.6	
<b>Race</b>	Malaysia	216	2.1	
	Indian	8	3.4	
	Chinese	5	91.9	
	Other	6	2.6	
<b>Education Level</b>	Bachelor of Degree	216	91.9	
	Diploma	18	7.7	
	Master Degree	1	0.4	
<b>Institution</b>	University Malaysia Kelantan (UMK)	123	52.3	
	University Teknologi Mara (UITM)	61	26.0	
	University Sains Malaysia (USM)	41	17.4	
	Others	10	4.3	
	Year 1	33	14.0	
	Year 2	34	14.5	
<b>Years of study</b>	Year 3	145	61.7	
	Year 4	23	9.8	
	<b>States</b>	Johor	16	6.8
		Kedah	22	9.4
Kelantan		115	48.9	
Kuala Lumpur		1	0.4	
Melaka		1	0.4	
Negeri Sembilan		3	1.3	
Pahang		18	7.7	
Perak		3	1.3	
Perlis		5	2.1	
Pulau Pinang		9	3.8	
Sabah		3	1.3	
Sarawak		4	1.7	
Selangor		11	4.7	
Terangganu		24	10.2	
		17	4.4	

The respondent profile is summarized in Table 2. For male respondents totaling 54 people makes male respondents get 23.0% while for female respondents totaling 181 people who get 77.0%. The most lagging behind age group is 21 to 23 with 78.3%, followed by 18 to 20 with 17.4%, 24 to 26 with 3.8%, and 27 and above with 0.4%. These age groups are easier to find due to their presence with more researchers. The single group had more respondents than the married group, single group have respondent 227 with 96.6% and married group

have respondent 8 with 3.4% as they were still studying and had more time to answer the questionnaire.

Next, the racial distribution of 384 respondents. ‘Malay’ respondents have the highest percentage where 91.95% with 216 number of respondents, followed by ‘Indians’ with 8 respondent at 3.4%. Then there are other races with 6 people at 2.6% and the least is ‘Chinese’ with 2.1% a total of 5 respondents. The number and percentage for the level of education for the respondents who answered this questionnaire are displayed. Which number from the degree level is the one that gets the highest number, which is (216 respondents) with 91.9%. While the second position is from the diploma level as many as (18 respondents) with 7.7% and the last one is from the master's which is only (1 respondent) with 0.4%. In this study there are four levels of study years involved where according to students who are in year 3 are the most dominant who answered the questionnaire that was distributed with 61.7% of 145 respondents. Next there is 14.5% with 34 respondents from year two. While 14.0% with 33 respondents and the least is from year 4 which is 9.8% with 23 respondents.

For each respondent's home state. The state of Kelantan is ranked highest at 48.9% with 115 respondents while the second highest is Terengganu at 10.2% with 24 respondents while Kedah gets 9.4% with 22 respondents, 2 less than Terengganu respondents. For the state of Pahang, it got 7.7% with 18 respondents. After that, for the state of Johor there is 6.8% for that state with 16 respondents. Selangor has 4.7% with 11 respondents followed by Penang 3.8% which means the total number of respondents is 9 people. Perlis is equivalent to 2.1% with a total of 5 respondents. While for the state of Sembilan, Perak and Sabah share 1.3% with 3 respondents. Likewise, Kuala Lumpur and Melaka have the same percentage of 0.4% with 1 respondent.

### Result of Descriptive Analysis

This study has analysed the mean and standard deviation for section of the questionnaires.

Table 3: Descriptive Statistics

Variable	Items	Mean Score	Standard Deviation
<b>Consumer Attitude</b>	I think buying organic food product is beneficial?	4.02	.889
	I think buying organic food product is a wise choice?	4.23	.814
	Buying organic food product make me feel good?	3.95	.818
	I believe organic food products is very useful to meet the nutritional needs	4.27	.844
	Buying organic food product make me feel pleased.	3.92	.836
<b>Price Perception</b>	I always choose the healthiest option although it is more expensive.	3.79	.968
	I think the price of organic food products is not a barrier to purchasing it.	3.71	1.005
	I think everyone should buy organic food	3.51	1.023

	products, even though they are more expensive.		
	I think the price of the organic food products is in accordance with the benefits.	4.01	.822
	I think the price of organic food product is high.	3.94	.868
<b>Health Concern</b>	I think often about my health.	4.31	.823
	I choose organic food product carefully to ensure good health.	4.18	.830
	I think organic food products have a beneficial effect on my health.	4.19	.746
	I think of myself as a health-conscious consumer.	4.19	.826
	I am concerned about the type and amount of nutrition in the food that I consume daily.	3.86	.936
<b>Environment Concern</b>	The balance of nature is very delicate and can be easily upset.	3.92	.834
	I pay a lot of intention to the environment.	4.20	.801
	I think environmental aspect is very important in my food choice.	4.25	.744
	I believe that organic food is more environmental friendly than conventional food.	4.07	.834
	I think humans must maintain a balance with nature in order to live a healthy life.	4.23	.767
<b>Motivation to Consume Organic Food Product</b>	Organic food products is good for the health.	4.22	.764
	Organic food products does not contain any chemicals.	4.10	.849
	Organic food products have more nutritional value than conventional food.	4.09	.796
	Organic food products consumption will help to protect the environment.	4.13	.814
	I would buy organic food products because of their quality.	4.20	.748

The mean and standard deviation analyses on the independent variable, consumer attitude. The maximum mean value was 4.27, where respondent strongly agreed is they believe organic food product is a very useful to meet the nutritional needs.

The mean and standard deviation analyses on the independent variable, price perception the highest mean score of 4.01, with the statement respondent think the price of the organic food products is in accordance with the benefits.

The mean and standard deviation analyses on the independent variable, health concern, item with the highest mean is 4.31, that strongly agreed by respondent think often about my health.

The mean and standard deviation analyses on the independent variable, environment concern, the highest mean value was 4.25, with statement " I think environmental aspect is very important in my food choice".

The mean and standard deviation analysis of respondent on the dependent variable, is motivation to consume organic food product where the item 1 shows the highest mean value score was 4.22, that respondent strongly agreed Organic food products is good for the health.

### Result of Reliability Test

Table 4: Results of Reliability Test

Variable	Number of items	Cronbach's Alpha coefficient	Strength of Association
Consumer attitude	5	.909	Excellent
Price perception	5	.799	Acceptable
Health concern	5	.858	Good
Environment concern	5	.822	Good
Motivation to consume organic food product	5	.896	Good

Table 4 show the reliability Cronbach's Alpha Coefficient values for the independent variables in this study. The data whole demonstrates the validity of Cronbach's Alpha.

Consumer attitude has the highest Cronbach's Alpha value, which is 0.909. Followed by motivation to consume organic food product among university in Kelantan. The second highest value at 0.896. The third highest was health concern with value score is 0.858. Followed by environment concern (0.822). Price perception had the lowest Cronbach's Alpha score which is 0.813. As a result all item for variables is trustworthy.

### Pearson Correlation

In this study, pearson correlation is intended to be used as a measure of the strength of the relationship between dependent variables (Motivation to Consume Organic Food Product) and independent variables (consumer attitude, price perception, health concern and environment concern). The table below show the interpretation of the correlation coefficient.

Table 5: Pearson Correlation Analysis

Hypothesis	Pearson's correlation	Result (Supported/Not Supported)
H <sub>1</sub> : There is a significant relationship between consumer attitude with motivation to consume organic food product.	$r = 0.620, p < 0.01$	H <sub>1</sub> is supported.
H <sub>2</sub> : There is significant relationship between price perception with motivation to consume organic food product	$r = 0.453, p < 0.01$	H <sub>2</sub> is supported.
H <sub>3</sub> : There is signification relationship between health concern with motivation to consume organic food product	$r = 0.678, p < 0.01$	H <sub>3</sub> is supported
H <sub>4</sub> : There is signification relationship between environment concern with motivation to consume organic food product.	$r = 0.639, p < 0.01$	H <sub>4</sub> is supported

Table 5 show the result of Pearson Correlation Analysis, for consumer attitude, the significant value, and the total number of respondent (235). The p-value was  $0.000 < 0.01$  level of significant. The consumer attitude and motivation to consume organic food product a positive with a correlation value of 0.620.

Next, for the price perception the significant value, and the total number of respondent (235). The p-value was  $0.000 < 0.01$  level of significant. The correlation value of 0.453 revealed positive relationship between price perception and motivation to consume organic food product.

Beside that, for the health concern, the significant value and total of respondent (235). The p-value was  $0.000 < 0.01$  level of significant. The correlation value of 0.678, there was positive between health concern and motivation to consume organic food product.

After that, for the environment concern, the significant value and total number of respondent (235). The p-value was  $0.000 < 0.01$  level of significant. Price perception and motivation to consume organic food have moderate correlation value of 0.639, it shows the positive relationship between environment concern and motivation to consume organic food product.

## **DISCUSSION AND RECOMMENDATION**

This study discovered that there are significant positive correlations between customer attitude, price perception, health concern, and environmental concern when it comes to purchasing organic food products. As a result, all of the research objectives have been met. This study inline with previous studies on motivation to consume organic food products (Rana & Paul, 2017); (Nguyen et al., 2019) & Ekasari et al., (2021).

After conducting this study, the researcher gave some recommendations for future research related to the topic covered in this study. Among the suggestions that future researchers can make is to further expand the target respondents for this study. Which is trying to research the use of organic food products among university students throughout Malaysia. Not only that, change to other populations such as among schools to see if school children already know about this organic food product. Using qualitative method for future research may enhanced the body of knowledge in organic food products by exploring other factors contributing to purchase intention. This is because in this study the quantitative method has already been used, therefore it is not wrong to try to use another available method which is qualitative to do research related to this organic food product.

Another suggestion is to change the other variables. What he needs to see is that there are still more variables that are more significant in this study. It is to ensure more research on these organic food products. In addition, new researchers can also try to make a pilot test first for the selected variable in order to see the results of the selected variable whether it is significant or not. The pilot test also aims to see whether the developed questionnaire is understood by the respondents or not. This is to ensure that the real respondents are not confused by the questions that will be distributed later.

## **CONCLUSION**

The objective of this research is to investigate the factors that contribute towards motivation to consume organic food products among university students. Findings from this quantitative study showed that all independent variables were significantly influencing students' motivation to consume organic food products. Thus this study provides novelty by providing academic and practical contributions in the area of healthy food consumption.

## REFERENCES

- Akter, M., Sadekin, M. N., & Patwary, A. K. (2020). An Empirical Study on Students' Satisfaction from Mawlana Bhashani Science & Technology University, Bangladesh. *Review of Economics and Development Studies*, 6(2), 363-379.
- Alom, S., Patwary, A. K., & Khan, M. M. H. (2019). Factors affecting the turnover intention of Bangladeshi migrants in the United Arab Emirates: An empirical study on the hotel industry. *International Journal of Innovation, Creativity and Change*, 8(3), 344-360.
- Chen, Y.-H. (2017). *Investigating the Motivation Factors of Food Choice During the Transition of High School into College Life among College Students Attending Western Kentucky University*. TopSCHOLAR®. <https://digitalcommons.wku.edu/theses/2032/>
- David, A. (2020). *Consumer Purchasing Process of Organic Food Product: An Empirical Analysis*. Ssrn.com. [https://papers.ssrn.com/sol3/papers.cfm?abstract\\_id=3705817](https://papers.ssrn.com/sol3/papers.cfm?abstract_id=3705817)
- Fengmin, Z., Baijun, W., Jiangtao, B., Li, L., & Patwary, A. K. (2022). Investigating revisit intention of medical tourists in China through nutritional knowledge, perceived medical quality, and trust in the physiologist: A recommendation on health tourism policy measures. *Frontiers in Public Health*, 10, 893497.
- Hazbar, A. M. H., Alem Mohammed, A., & Karim, A. K. A. (2019). An Empirical Study of Factors Influencing hotel customers' online booking Intention. *مجلة العلوم التربوية و الدراسات الإنسانية*, (5), 1-17. <https://doi.org/10.37394/232015.2020.16.76>
- Li, L., Ragavan, N. A., Patwary, A. K., & Baijun, W. (2022). Measuring patients' satisfaction toward health tourism in Malaysia through hospital environment, nutritional advice, and perceived value: A study on Chinese exchange students. *Frontiers in public health*, 10, 893439.
- Li, L., Wu, B., & Patwary, A. K. (2022). How marine tourism promote financial development in sustainable economy: new evidences from South Asia and implications to future tourism students. *Environmental Science and Pollution Research*, 29, 1155-1172.
- Li, L., Wu, B., & Patwary, A. K. (2022). The psychosocial factors affecting chinese Outbound Exchange and mobility students' academic performance during COVID-19. *Frontiers in psychology*, 13, 872516.
- Melovic, B., Cirovic, D., Dudic, B., Vulic, T. B., & Gregus, M. (2020). The Analysis of Marketing Factors Influencing Consumers' Preferences and Acceptance of Organic Food Products—Recommendations for the Optimization of the Offer in a Developing Market. *Foods*, 9(3), 259. <https://doi.org/10.3390/foods9030259>
- NGUYEN, D. T., & TRUONG, D. C. (2021). The impact of psychological and environmental factors on consumers' purchase intention toward organic food: Evidence from Vietnam. *The Journal of Asian Finance, Economics and Business*, 8(1), 915-925.
- Organic Foods: Do Eco-Friendly Attitudes Predict Eco-Friendly Behaviors?* (2023). *Journal of American College Health*. <https://www.tandfonline.com/doi/full/10.1080/07448480903295292?scroll=top&needAccess=true&role=tab>

- Pang, S. M., Tan, B. C., & Lau, T. C. (2021). Antecedents of Consumers' Purchase Intention towards Organic Food: Integration of Theory of Planned Behavior and Protection Motivation Theory. *Sustainability*, 13(9), 5218. <https://doi.org/10.3390/su13095218>
- Patwary, A. K., Roy, B., Hoque, R., & Khandakar, M. S. A. (2019). Process of developing a community based tourism and identifying its economic and social impacts: An Empirical study on Cox's Bazar, Bangladesh. *Pakistan Journal of Humanities and Social Sciences*, 7(1), 1-13.
- Purchase Intention Towards Organic Food Among Undergraduate Students. (2020). *WSEAS TRANSACTIONS on ENVIRONMENT and DEVELOPMENT*, 16.
- Raffaele Zanoli, & Naspetti, S. (2002, September). *Consumer motivations in the purchase of organic food: A means-end approach*. ResearchGate; Emerald. [https://www.researchgate.net/publication/232702309\\_Consumer\\_motivations\\_in\\_the\\_purchase\\_of\\_organic\\_food\\_A\\_means-end\\_approach](https://www.researchgate.net/publication/232702309_Consumer_motivations_in_the_purchase_of_organic_food_A_means-end_approach)
- Rana, J., & Paul, J. (2017). Consumer behavior and purchase intention for organic food: A review and research agenda. *Journal of Retailing and Consumer Services*, 38, 157–165. <https://doi.org/10.1016/j.jretconser.2017.06.004>
- Shukla, S. (2020, June 25). *CONCEPT OF POPULATION AND SAMPLE*. ResearchGate;
- Singh, A., & Verma, P. (2017). Factors influencing Indian consumers' actual buying behaviour towards organic food products. *Journal of Cleaner Production*, 167, 473–481.
- Sumethokula, P., Patwary, A. K., Srinuanpanc, B., Srinuanpand, C., Suwandee, P., Thammathikulf, A., & Phanong, W. (2020). The potential of new tour repackaging for creative tourism among entrepreneurs in Nakhon Si Thammarat. *International Journal of Innovation, Creativity and Change*, 13(10), 1752-1771.
- Taherdoost, H. (2016). Sampling Methods in Research Methodology; How to Choose a Sampling Technique for Research. *SSRN Electronic Journal*, 5(2), 18–27. [https://papers.ssrn.com/sol3/papers.cfm?abstract\\_id=3205035](https://papers.ssrn.com/sol3/papers.cfm?abstract_id=3205035)
- Tobler, C., Vivianne H.M. Visschers, & Siegrist, M. (2011). *Eating green. Consumers' willingness to adopt ecological food consumption behaviors*. 57(3), 674–682. <https://doi.org/10.1016/j.appet.2011.08.010>
- Traditional Food Production and Rural Sustainable Development*. (2023). Google Books. [https://books.google.com.my/books?hl=en&lr=&id=o3N7\\_b0IdIoC&oi=fnd&pg=PA173&ots=ammaceyj-c&sig=x8KbhNIX4cI8qlhXqOYE1MOAJAc&redir\\_esc=y#v=onepage&q&f=false](https://books.google.com.my/books?hl=en&lr=&id=o3N7_b0IdIoC&oi=fnd&pg=PA173&ots=ammaceyj-c&sig=x8KbhNIX4cI8qlhXqOYE1MOAJAc&redir_esc=y#v=onepage&q&f=false)
- unknown. [https://www.researchgate.net/publication/346426707\\_CONCEPT\\_OF\\_POPULATION\\_AND\\_SAMPLE](https://www.researchgate.net/publication/346426707_CONCEPT_OF_POPULATION_AND_SAMPLE)
- Wu, B., Liu, S., Wang, J., Tahir, S., & Patwary, A. K. (2021). Assessing the mechanism of energy efficiency and energy poverty alleviation based on environmental regulation policy measures. *Environmental Science and Pollution Research*, 28, 40858-40870.
- Wu, B., Zhai, B., Mu, H., Peng, X., Wang, C., & Patwary, A. K. (2021). Evaluating an economic application of renewable generated hydrogen: A way forward for green economic performance and policy measures. *Environmental Science and Pollution Research*, 1-15.



# **The Exploring Study Of Postpartum Depression Prevalence Among Women In Kelantan**

**Aimeeliya Binti Mohd Sham, Chan Pei Ling, Muhammad Khuzaimi Bin Zamuri, Nik Nor Shahieda Binti Nik Mood**

**\*Dr. Ahmad Fahme Bin Mohd Ali\***

*Faculty of Hospitality, Tourism and Wellness, Universiti Malaysia Kelantan Corresponding email:*

---

## **ABSTRACT**

*Postpartum depression is a very serious and well-known type of depression, especially among women around the world. This study shows the symptoms that contribute to postpartum depression, the risk of postpartum depression and the impact of postpartum depression. Therefore, this study aims to examine the symptoms that contribute to postpartum depression, the risk of postpartum depression and the impact of postpartum depression. This study has used a quantitative method by using "google form" to examine the questionnaire which is a variable that has been created where all the variables have a significant relationship with postpartum depression. All the data provided in this study will provide assistance to the parties concerned to help reduce this health problem. If the results obtained are positive then Malaysian women agree with the statement.*

**Keywords: Postpartum Depression, Symptoms, Risk, Impact**

---

## INTRODUCTION

According to Debra Fulghum Bruce (2022) postpartum depression is a complicated combination of alterations in behaviour, emotion, and physical health. Postpartum Depression is a type of severe depression that starts four weeks after giving delivery, according to the manual used to identify mental disease (Debra Fulghum Bruce, 2022). Based on the condition's severity and the time between delivery and onset, postpartum depression is diagnosed. Postpartum depression may be related to the biological, social, and psychological changes that take place while having a kid. This phrase can be used to describe the many emotional and physical changes that many new mothers go through. Therefore, this study proposes three research objectives to explain the statement.

To investigate the type of postpartum depression symptom among women

To investigate the risk factors that contribute to postpartum depression among women

To investigate the Impact of depression postpartum among women **Significance of The Study**

This study is important for women as the prevalence of postpartum depression among women is one in seven, and that number only includes those who have received a diagnosis of Postpartum Depression (PPD). It is clear to educate women about postpartum depression and receive depression treatment. Before giving birth, giving women exposure to help identify the signs of postpartum depression and seek treatment without feeling ashamed of their feelings. Not exposing women who suffer from postpartum depression will leave them vulnerable to relapse of mental illness and in some cases suicide. By informing women and their partners about early symptoms and signs, childbirth educators can play an important role in helping women end this silence (Norhayati et al., 2015).

## LITERATURE REVIEW

Postpartum depression- A psychological disorder after childbirth that is at a high level that can affect as much as 13% of mothers who have just given birth.

Symptom- There are studies that show that depression and obesity have a close relationship. The evidence is that the risk of depression increases by 37% due to obesity among women. It is common for women to gain excess weight during pregnancy and after giving birth.

Risk factor- Some of the risk factors for a history of depression, depression during pregnancy, prenatal anxiety, stressful life events, low self-esteem, a lack of social support, and low income are all risk factors for postpartum depression.

Impact - Postpartum depressed mothers commonly experience suicide thoughts, are less emotionally present for their kids, and have babies with looser attachments.

## Research Hypothesis

The hypothesis is also a provisional response to your untested research questions. It's crucial to base your hypothesis on the research goal as well. The independent and dependent variables will be used in the study to help the researcher construct the hypothesis. Therefore, a hypothesis must contain the following four components: a research purpose, an independent variable, and a dependent variable. For this research paper which is titled "Postnatal depression among women".

H1: There is a relationship between the type of postpartum depression and the occurrence symptoms of postpartum depression.

H2: There is a relationship between risk factors and the occurrence of postpartum depression.

H3: There is a relationship between the occurrence of impact and postpartum depression.

### Research Framework

People who looked at the literature came up with a way to look at the relationship between the factors and how they faced the problems. It looks like this in Figure 2.1: symptoms of depression, risk factor, and impact of depression are three of the three independent variables that have been suggested as possible factors. The dependent variable is postnatal depression among women.

#### Independent Variables

#### Dependent Variables

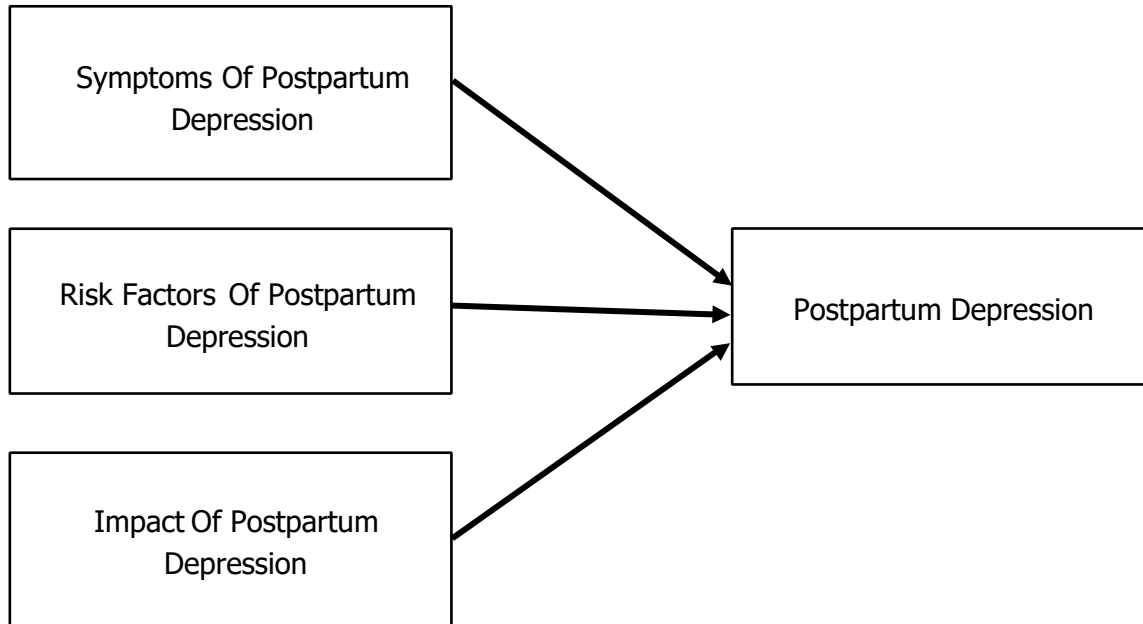

### METHODOLOGY

In this chapter, we will use systematic techniques to achieve the research requirements, scientific and quality methods. In addition, this chapter will also discuss how to carry out this study to obtain information in order to achieve the objectives and goals of the study. With this, all steps or procedures set must achieve the objective of this study by undergoing some necessary methods.

#### Research Design

We will use a quantitative approach as a research design to the study we conducted to examine the perception of postpartum depression among women. The quantitative approach we will use is to provide a questionnaire to the respondents. We selected this quantitative approach in part because it is testable and verifiable. This is because it necessitates thorough study design, which will increase the reliability of the data obtained and reduce the likelihood of disagreements, controversies, and objections (Gigi DeVault, 2020). This technique also has the ability to display the analysis directly. This is so that we can determine which statistical test to perform while gathering quantitative data based on the type of results. Because of this, analysing and presenting the data is simple and less vulnerable to inaccuracy and subjectivity (Gigi Devault, 2020).

## **Data Collection**

### **• Primary data**

Information that is obtained for the first time with the goal of resolving a problem is referred to as primary data. Surveys, tests, questions, focus groups, interviews, and questionnaires are a few examples of primary data sources. Respondents are given questionnaires as the main method of data gathering in this study. The major data source, according to Ajayi (2017), is a questionnaire that asks respondents a series of questions.

### **• Secondary data**

Any material from published sources that has been gathered specifically for the current study topic is referred to as secondary data. Publications like books, journals, articles, websites, and blogs are examples of secondary data sources. To make decisions more understandable, secondary data is employed to fill in the holes in descriptions. Additionally, this study may be used to manage information libraries for pertinent sources in internet sources like Newspaper online and Emerald.

### **• Research instrument**

The instrument that will be utilised to gather the data for this study is a survey questionnaire. Respondents in Kelantan will get the questionnaire, which will then be assessed. There are two sections to the questionnaire: part A, part B, and part C. Part A asks questions about the respondents' sociodemographic characteristics, such as their gender, age, religion, employment, and races. Parts B and C of the questionnaire ask respondents in Kelantan about postpartum depression-related characteristics.

## **Sampling**

Non-probability sampling will be used in this study, and also the researcher uses random sampling. Questionnaire forms will be distributed to respondents at the Kelantan to ask respondents to answer the questionnaire. The researcher will ask if the respondent has known or experienced postpartum depression.

## **Data Analysis**

Data analysis is the intentional application of logical and/or statistical approaches to describe and illustrate, summarise and assess, and analyse data. Data analysis, according to Copper, Schindler, and Sun (2006), is the act of editing and limiting data that is necessary to evaluate the results and answer the research question. In this study, descriptive analysis, correlation analysis, and reliability and validity analysis were used to examine the data collected from questionnaires given to respondents. SPSS software was then used to assess the data.

## **FINDINGS**

This chapter will look at the results and recommendations of the data analysis done on the survey information received from the 384 research participants. The information that was processed to find out how common postpartum depression is among women in Kelantan. In addition, the hypothesis might be tested, and the study's research goal may be satisfied. The data are analysed using SPSS version 26.

## **Demographic Characteristics of Respondents**

### **Age**

There were 384 respondents, who consist of age from 18 to 29 years old is 97 respondents (25.3%). The respondent age from 30 to 39 years old is 171 respondents (44.5%). The respondents age from 40

to 49 years old is 66 respondents (17.2%). While, the respondents age from 50 to 59 years old is 39 respondents (10.2%) and the respondents age from 60 above years old is 11 respondents (2.9%).

### **Race**

This shows that the highest age of respondents is 30 – 39 years old which is 171 respondents (44.5%). Meanwhile, the lowest age of respondents is 60 years old above which is 11 respondents (2.9%). The information shows that the highest frequency is Malay which is 302 respondents (78.6%). The second highest frequency of race is Chinese which is 69 respondents (18.0%). Meanwhile, the lowest frequency of race is Indian which is 11 respondents (2.9%). The second lowest frequency of race is Others which is 2 respondents (5%).

### **Education Status**

The highest education status of respondents is SPM which is 172 respondents (44.8%). The second highest education status of respondents is Bachelor which is 74 respondents (19.3%). Next, the third highest education status of respondents is STPM / Sijil / Diploma / Foundation / Matriculation which is 66 respondents (17.2%). The fourth highest education status of respondents is Primary School which is 20 respondents (5.2%). The lowest education status of respondents is PMR / PT3 which is 19 respondents (4.9%). The second lowest education status of respondents is Master which is 14 respondents (3.6%). Next, the third lowest education status of respondents is who are does not go to school which is 13 respondents (8.2%). Last but not least, the extremely lowest education status is Phd which is 6 respondents (1.6%).

### **Employment Status**

Respondent who are not working has the highest data which is 118 respondents (30.7%). Respondents who work in government sector has 102 respondents (26.6%). Respondents who work in private sector has 69 respondents (18%) while respondents who work in self-employed has 54 respondents (14.1%). The second lowest employment status of respondents is student which is 27 respondents (7%) and the first lowest employment status of respondents is retired which is 14 respondents (3.6%) in 384 respondents.

### **Residential Area**

The total number of respondents for who are at city area was 214 respondents while the number of respondents for who are at rural area was 170 respondents. Out of 384 respondents, 55.7% of total respondents were at city area. Meanwhile, 44.3% were respondents at rural area.

### **Marital Status**

The total number of respondents for mother gave birth after marriage was the highest number of respondent which is 369 respondents (96.1%). Meanwhile, the total number of respondents for mother gave birth before marriage was the lowest number of respondent which is 15 respondents (3.9%).

### **Number of Children**

Respondent who have 1 child in family has 45 respondents (11.7%). Respondents who have 2 child in family has 95 respondents (24.7%). Respondents who have 3 child in family has 133 respondents (34.6%). Respondents who have 4 child in family has 69 respondents (18.0%). Respondents that who have 5 child in family has 15 respondents (3.9%) and 6 child in family has 19 respondents (4.9%).

Lastly, the respondents that who have more than 6 child in family has 8 respondents (2.1%). This can be show that the highest number of children of respondent is 3 child in family which is 133 respondents (34.6%). Meanwhile, the lowest number of children of respondents is more than 6 child in family which is 8 respondents (2.1%).

### **Mental Health Screening**

The group of respondents who get the mental health screening is 22 respondents (5.7%). There were 362 respondents (94.3%) who did not get the mental health screening during pregnancy.

### **Pregnant Status**

The group of respondents who was pregnant is 18 respondents (4.7%). There were 366 respondents (95.3%) who not pregnant.

### **Result of Descriptive Analysis**

Table 4.10: Descriptive Analysis.

<b>Variables</b>	<b>N</b>	<b>Mean</b>	<b>Standard Deviation</b>
Postpartum Depression	384	2.5036	0.92891
Symptoms of Postpartum Depression	384	2.4365	0.89320
Risks Factors of Postpartum Depression	384	2.7240	0.73315
Impact of Postpartum Depression	384	2.6090	0.79701

The value of the respondents, mean and the standard deviation of the dependent variable and independent variables. The highest mean for the variables is Risk Factors of Postpartum Depression which is 2.72. The second highest mean for the variables is Impact of Postpartum Depression which is 2.61. The third ranking for the variables is Postpartum Depression which is 2.50 and the last ranking for the variables is Symptoms of Postpartum Depression which is 2.44.

### **Postpartum Depression (DV)**

The mean, standard deviation and the ranking of the Postpartum Depression (Dependent Variable) in this research paper. The result based on the table above shows that respondent are strongly agreed that “I still can able to laugh and see the funny side of things after giving birth”, this is because it has the highest value of 2.88. Besides, the respondent also agreed with the statement “I will feel fear or panic for no good reason”, it is because the second highest value of this statement is 2.55. The third highest mean of the statement is “I would feel so unhappy that is would cause they to cry for no reason” to a mean score of 2.50. Next, followed by a score of 2.44 is “Thoughts of hurting myself would cross my mind after giving birth” then “I would blame myself for no reason when I had problems”, “I will feel anxious or worried for no good reason after giving birth” and “ I would feel so unhappy that I would

have difficulty sleeping after giving birth” with a score of 2.42. Lastly, the lowest score of the statement is “I felt very sad and miserable after giving birth” which is 2.40. In conclusion, the average mean of the Postpartum Depression (Dependent Variable) is 2.88 the highest score which is this indicates that respondents are strongly agree with this statement.

### **Symptoms of Postpartum Depression (IV1)**

The mean, standard deviation and the ranking of the Symptoms of Postpartum Depression (Independent Variable) in this research paper. The result based on the table above shows that respondent are strongly agreed that “I have trouble falling asleep or sleeping too much”, this is because it has the highest value of 2.84. Besides, the respondent also agreed with the statement “I feel completely overwhelmed, as though I will never be a good mom”, it is because the second highest value of this statement is 2.59. The third highest mean of the statement is “I feel constantly irritated or angry, and have zero patience” to a mean score of 2.42. Next, followed by a score of 2.39 is “I have thoughts of harming myself or baby” then “I feel out of focus and can't concentrate on anything, least of all my newborn” and “I feel alone, despite just having added a baby to my life” with a score of 2.33. Next, followed by a score of 2.31 is “I feel no bond or connection to this new life I helped create” Lastly, the lowest score of the statement is “I feel uncontrollably sad and can't stop crying or shake off feelings of sadness” which is 2.28. In conclusion, the average mean of the Symptoms of Postpartum Depression (Independent Variable) is 2.84 the highest score which is this indicates that respondents are strongly agree with this statement.

### **Risk Factors of Postpartum Depression (IV2)**

In this study work, the mean, standard deviation, and ranking of the Risk of Postpartum Depression (Independent Variable) are presented. According to the table above, respondents strongly agree that "I received support from my family members after giving birth," which has the highest score of 3.09. Furthermore, the respondent agreed with the statement "My lifestyle changed after I gave birth" because it has the second highest value of 2.99. The third highest mean of the statement is “I experienced physical changes after giving birth” to a mean score of 2.96. Next, followed by a score of 2.94 is “I have a history of depression in my family” then “I had problems breastfeeding after giving birth” with a score of 2.80. "I faced high life pressure after giving birth," followed by a score of 2.44, comes next. Finally, the statement with the lowest score is "I experienced a lack of social support after giving birth" and "I always feel worried and sad after giving birth," which has a score of 2.43. In conclusion, the average mean of the Risks of Postpartum Depression (Independent Variable) is 3.09 the highest score which is this indicates that respondents are strongly agree with this statement.

### **Impact of Postpartum Depression (IV3)**

The mean, standard deviation and the ranking of the Impact of Postpartum Depression (Independent Variable) in this research paper. The result based on the table above shows that respondent are strongly agreed that “Anyone can get postpartum depression”, this is because it has the highest value of 3.32. Furthermore, because the second highest value of this item is 3.10, the respondent agreed with the statement "Postpartum depression can have an effect on children." The third highest mean of the statement is “Risk factors are things that make it more likely that I will get illness as compared to someone else” to a mean score of 2.50. Next, followed by a score of 2.47 is “I'm worry that I might hurt myself or others” then “I start a support group for women with perinatal mood and anxiety disorder” and “I don't feel bonded to my baby” with a score of 2.40. "I have taken medication to be treated for postpartum depression," followed by a score of 2.36, comes next. Finally, the statement with the lowest score is "I get postpartum depression much later after the birth of my child," which has a score of 2.33. In conclusion, the average mean of the Impact of Postpartum Depression (Independent Variable) is 3.32 the highest score which is this indicates that respondents are strongly agree with this statement.

### Reliability Analysis

Reliability analysis was used to evaluate the validity of the survey. Cronbach's Alpha analysis was used to test the data to make sure it was reliable and accurate on the inside as well. The size of the Cronbach's Alpha coefficient according to the Rules of Thumb from Hair et al. (2007). The dependent and independent variables performed overall. Before being distributed online to 384 people, the survey was piloted with 30 participants.

Table 4.16: Result of Reliability Coefficient Alpha for the Independent Variables and Dependent Variable.

Variable	Number of Item	Cronbach's Alpha Coefficient	Strength of Association
Postpartum Depression	8	0.909	Excellent
Symptoms	8	0.934	Excellent
Risk Factors	8	0.752	Good
Impact	8	0.706	Good
Overall Variable	32	3.30	Excellent

The total Cronbach's Alpha Coefficient for the survey variables used in the study. The table shows that the total number of variables was 3.30 and that every variable had a value greater than 0.70. The question in this section had a Cronbach's Alpha of 0.909, which is considered to be extremely excellent. For the queries containing the personal variable, the coefficients produced were precise. There were eight surveys used to gauge how postpartum mothers in Kelantan were feeling. The Cronbach's Alpha score for this part, 0.934, is regarded as being quite high. As a result, the coefficient produced for the symptoms questions was precise and appropriate for use in this study. The risk factors that influenced postpartum mothers in Kelantan were also evaluated using eight questionnaires. The question in this area had a very strong Cronbach's Alpha rating of 0.752. The coefficient calculated for the risk factors variable questions was accurate as a consequence. The information regarding the postpartum in Kelantan was gathered using eight questions, and the Cronbach's Alpha value for this section's question was 0.706, which is good. As a result, the coefficient discovered for this inquiry regarding postpartum depression's influence among postpartum women in Kelantan was also reliable.



### Pearson's Correlation Coefficient

Depending on the level of the correlation, Pearson's correlation is used to assess the strength of the relationship between the independent and dependent variables (Piaw, 2006).

Table 4.21: Overall of The Exploring Study Of Postpartum Depression Prevalence Among Women In Kelantan.

		Symptoms of Postpartum Depression	Risk Factor of Postpartum Depression	Impact of Postpartum Depression	Postpartum Depression
<b>Symptoms of Postpartum Depression</b>	Pearson Correlation	1	.634**	.772**	.794**
	Sig. (2tailed)		.000	.000	.000
	<i>N</i>	384	384	384	384
<b>Risk Factor of Postpartum Depression</b>	Pearson Correlation	.634**	1	.685**	.580**
	Sig. (2tailed)	.000		.000	.000
	<i>N</i>	384	384	384	384
<b>Impact of Postpartum Depression</b>	Pearson Correlation	.772**	.685**	1	.696**
	Sig. (2tailed)	.000	.000		.000
	<i>N</i>	384	384	384	384
<b>Postpartum Depression</b>	Pearson Correlation	.794**	.580**	.696**	1
	Sig. (2tailed)	.000	.000	.000	
	<i>N</i>	384	384	384	384

### **H1: There is a relationship between the type of postpartum depression and the occurrence symptoms of postpartum depression.**

With a correlation coefficient value of .794\*\*, postpartum depression symptoms and kind are somewhat positively correlated with one another among women in Kelantan. This demonstrates that postpartum depression symptoms are mildly positive and consistent with the sort of postpartum depression experienced by women in Kelantan. The postpartum depression type's p value for the symptoms is .000, which is less than the very significant level of .001.

### **H2: There is a relationship between risk factors and the occurrence of postpartum depression.**

With a correlation coefficient value of .580\*\*, the association between risk variables and the occurrence of postpartum depression among women in Kelantan is moderately positive. This demonstrates that there is a modestly favourable link between postpartum depression risk factors and the prevalence of the condition among mothers in Kelantan. The risk factor for postpartum depression has a p value of .000, which is lower than the very significant threshold of .001 for postpartum depression.

### **H3: There is a relationship between the occurrence of impact and postpartum depression.**

The relationship between the relationship between the occurrence of impact and postpartum depression among women in Kelantan is moderately positive with a correlation coefficient value is .696\*\*. This shows that the relationship between the occurrence of impact and postpartum depression is positive and moderately in relation to the postpartum depression among women in Kelantan. The p value on the occurrence of impact in postpartum depression is .000 which is less than the very significant level at .001.

### **Overall Of The Exploring Study Of Postpartum Depression Prevalence Among Women In Kelantan.**

The association between postpartum depression, the dependent variable, and symptoms, risk factors, and the impact of postpartum depression among women in Kelantan, the independent variable. With a correlation coefficient of .794\*\*, it can be seen that postpartum depression is positive and moderately related to symptoms of postpartum depression among women in Kelantan. With a correlation value of .580\*\*, postpartum depression is positive and modestly related to postpartum depression risk variables among women in Kelantan. With a correlation coefficient of .696\*\*, postpartum depression is also positively related to the effects of postpartum depression on women in Kelantan. The p value of the postpartum depression, symptoms, risk factor and impact of postpartum depression is .000 which is less than the highly significant level .001.

## **DISCUSSION AND RECOMMENDATION**

### **To Investigate A Relationship Between The Type Of Postpartum Depression And The Occurrence Symptom Of Postpartum Depression.**

The first objective is to investigate the relationship between types of postpartum depression among women. Based on the results obtained, the mean average is 2.44. Most of the respondents with experience of giving birth strongly agree with the statement that indicates having a postpartum

depression system. Women must be educated about postpartum depression and receive treatment for depression before giving birth. Before giving birth, getting to know women will help them identify the signs of postpartum depression and seek treatment instead of feeling ashamed of their feelings.

### **To Investigate A Relationship Between Risk Factors And The Occurrence Postpartum Depression.**

The second objective is to investigate the relationship between risk factors that contribute to postpartum depression among women. Based on the results obtained, the average mean is 2.72. Most respondents strongly agreed with the statement that there are risks that contribute to postpartum depression. Women with postpartum depression are often undiagnosed and may hide their symptoms, leaving them to suffer in silence. By informing women and their partners about the early symptoms and signs of postpartum depression, maternity educators can play an important role in helping women end it, it is impossible to predict whether women will develop postpartum depression after silence (Norhayati et al., 2015).

### **To Investigate A Relationship Between The Occurrence Of Impact And Depression Postpartum.**

The third goal is to look into the connections between postpartum depression in women and its repercussions. Based on the results obtained, the average mean is 2.61. Most of the respondents who experienced childbirth strongly agreed with the statement showing the effects of postpartum depression. When a woman is not treated for postpartum depression, the consequences can cause several marital diseases, susceptibility to mental relapses and relapses, in cases, suicide (Norhayati et al., 2015).

Based on the previous chapter, some empirical The Exploring Study of Postpartum Depression Prevalence Among Women in Kelantan. As a result, some recommendations improving the research for future study to increase the number of respondents based on pregnant women researchers can broaden the study area from one state to another (for example, Malaysia). This will increase the number of respondents, which may improve the results. Even the number of questions in each section can be increased by comparing places researched by demographics elsewhere.

## **CONCLUSION**

In conclusion, the purpose of this study was to examine the associations between postpartum depression symptoms, risk factors, and effects in postpartum women in Kelantan. The studied material is used to create the conceptual framework. The link between the independent and dependent variables was the subject of the investigation. 384 people responded to the online survey, which was carried out. Using SPSS software version 28, descriptive statistics, reliability analysis, and correlation analysis were used to collect and evaluate the data. The reliability study revealed that the total variables were 0.934. The provided finding is therefore reliable and suitable for inclusion in this study.

## **REFERENCES**

[Fadzlina], StraComm USIM. "Kemurungan Dan Panduan Islam Dalam Menghadapinya."Universiti Sains Islam Malaysia, 5 Jan. 2023, [www.usim.edu.my/ms/berita/in-our-words-ms/kemurungan-dan-panduan-islamdalammenghadapinya](http://www.usim.edu.my/ms/berita/in-our-words-ms/kemurungan-dan-panduan-islamdalammenghadapinya)

- “‘Ibu Meroyan’: Fakta Atau Auta? | Pusat Pakar Psikologi Jiwadamai.” ‘Ibu Meroyan’: Fakta Atau Auta? | Pusat Pakar Psikologi Jiwadamai, 22 Jan. 2021, [jiwadamai.com/2021/01/22/ibu-meroyan-fakta-atau-auta](http://jiwadamai.com/2021/01/22/ibu-meroyan-fakta-atau-auta).
- “An Overview of Postpartum Depression.” WebMD, 23 Aug. 2022, [www.webmd.com/depression/postpartum-depression/postpartum-depression](http://www.webmd.com/depression/postpartum-depression/postpartum-depression).
- “Apakah Itu Kemurungan? - Prof Dr Ramli Musa.” Prof Dr Ramli Musa, 27 May 2008, [www.ramlimusa.com/92-2](http://www.ramlimusa.com/92-2).
- “Incidence of Postnatal Depression in Malaysian Women - PubMed.” PubMed, 1 Feb. 1997, [pubmed.ncbi.nlm.nih.gov/9094824](http://pubmed.ncbi.nlm.nih.gov/9094824).
- “Kemurungan Selepas Bersalin Di Kalangan Wanita: Satu Kajian Kes Di Sebuah Institusi Pengajian Tinggi Awam Selatan Semenanjung Malaysia - Malaysian Education Research Repository.” Kemurungan Selepas Bersalin Di Kalangan Wanita: Satu Kajian Kes Di Sebuah Institusi Pengajian Tinggi Awam Selatan Semenanjung Malaysia - Malaysian Education Research Repository, [merr.utm.my/13515](http://merr.utm.my/13515). Accessed 6 Jan. 2023.
- “Population Definition in Statistics and How to Measure It.” Investopedia, 14 July 2022, [www.investopedia.com/terms/p/population.asp](http://www.investopedia.com/terms/p/population.asp).
- “Research Guides: Organizing Academic Research Papers: Types of Research Designs.” Types of Research Designs - Organizing Academic Research Papers – Research Guides at Sacred Heart University, 8 Dec. 2022, [library.sacredheart.edu/c.php?g=29803&p=185902](http://library.sacredheart.edu/c.php?g=29803&p=185902).
- “Sampling and Sampling Methods.” Sampling and Sampling Methods - MedCrave Online, 4 May 2017, [medcraveonline.com/BBIJ/BBIJ-05-00149.pdf](http://medcraveonline.com/BBIJ/BBIJ-05-00149.pdf).
- “Statistik Kemurungan 2021 | Penjagaan Tunggal - Berita | Januari 2023.” Statistik Kemurungan 2021 | Penjagaan Tunggal - Berita | Januari 2023, [ms.covidografia.pt/news/depression-statistics-2021](http://ms.covidografia.pt/news/depression-statistics-2021). Accessed 6 Jan. 2023.
- “Statistik Kemurungan Selepas Bersalin Di Malaysia - Google Search.” Statistik Kemurungan
- “The Effects of Depression on the Body and Physical Health.” The Effects of Depression on the Body and Physical Health, [www.medicalnewstoday.com/articles/322395](http://www.medicalnewstoday.com/articles/322395). Accessed 6 Jan. 2023.
- Akter, M., Sadekin, M. N., & Patwary, A. K. (2020). An Empirical Study on Students’ Satisfaction from Mawlana Bhashani Science & Technology University, Bangladesh. *Review of Economics and Development Studies*, 6(2), 363-379.
- Alom, S., Patwary, A. K., & Khan, M. M. H. (2019). Factors affecting the turnover intention of Bangladeshi migrants in the United Arab Emirates: An empirical study on the hotel industry. *International Journal of Innovation, Creativity and Change*, 8(3), 344-360.
- Aspers, Patrik, and Ugo Corte. “What Is Qualitative in Qualitative Research – Qualitative Sociology.” SpringerLink, 27 Feb. 2019, [link.springer.com/article/10.1007/s11133019-9413-7](http://link.springer.com/article/10.1007/s11133019-9413-7).

- Brown, Geo H. "A Comparison of Sampling Methods." *Journal of Marketing*, vol. 11, no. 4, SAGE Publications, Apr. 1947, pp. 331–37. Crossref, <https://doi.org/10.1177/002224294701100401>.
- DelRosario, Genevieve A., et al. "Postpartum Depression: Symptoms, Diagnosis, and Treatment Approaches." *Journal of the American Academy of Physician Assistants*, vol. 26, no. 2, Ovid Technologies (Wolters Kluwer Health), Feb. 2013, pp. 50–54. Crossref, <https://doi.org/10.1097/01720610-201302000-00009>.
- Encyclopedia of Bioinformatics and Computational Biology, 706–72.
- Fengmin, Z., Baijun, W., Jiangtao, B., Li, L., & Patwary, A. K. (2022). Investigating revisit intention of medical tourists in China through nutritional knowledge, perceived medical quality, and trust in the physiologist: A recommendation on health tourism policy measures. *Frontiers in Public Health*, 10, 893497.
- Franzese, M., Iuliano, A. (2018). Correlation analysis. In:
- Habidin, N., Zubir, A., Fuzi, N., Md Latip, N. A., & M.N.A, A. (2015). Sustainable Performance Measures for Malaysian Automotive Industry.33, 1017-1024. doi:10.5829/idosi.wasj.2015.33.06.257
- Hazbar, A. M. H., alem Mohammed, A., & Karim, A. K. A. (2019). An Empirical Study of Factors Influencing hotel customers' online booking Intention. *مجلة العلوم التربوية و الدراسات الإنسانية*, (5), 1-17.
- Li, L., Ragavan, N. A., Patwary, A. K., & Baijun, W. (2022). Measuring patients' satisfaction toward health tourism in Malaysia through hospital environment, nutritional advice, and perceived value: A study on Chinese exchange students. *Frontiers in public health*, 10, 893439.
- Li, L., Wu, B., & Patwary, A. K. (2022). How marine tourism promote financial development in sustainable economy: new evidences from South Asia and implications to future tourism students. *Environmental Science and Pollution Research*, 29, 1155-1172.
- Li, L., Wu, B., & Patwary, A. K. (2022). The psychosocial factors affecting chinese Outbound Exchange and mobility students' academic performance during COVID-19. *Frontiers in psychology*, 13, 872516.
- Middleton, F. (2020, June 26). Reliability vs validity: what's the difference? Retrieved from <https://www.scribbr.com/methodology/reliability-vsvalidity/#:~:text=Reliability%20and%20validity%20are%20concepts,the%20accuracy>
- Mohd Arifin, Siti Roshaidai, et al. "Postpartum Depression in Malaysian Women: The Association With the Timing of Pregnancy and Sense of Personal Control During Childbirth." *International Journal of Academic Research*, vol. 6, no. 3, Progress IPS, May 2014, pp. 143–49. Crossref, <https://doi.org/10.7813/2075-4124.2014/6-3/b.21>.
- Patwary, A. K., Roy, B., Hoque, R., & Khandakar, M. S. A. (2019). Process of developing a community based tourism and identifying its economic and social impacts: An Empirical

study on Cox's Bazar, Bangladesh. *Pakistan Journal of Humanities and Social Sciences*, 7(1), 1-13.

Ratnasari, D., Nazir, F., Husein Zilullah Toresano, L. O., Pawiro, S., & Soejoko, D. (2016). The correlation between effective renal plasma flow (ERPF) and glomerular filtration rate (GFR) with renal scintigraphy 99m Tc-DTPA study. *Journal of Physics: Conference Series*, 694, 012062. doi:10.1088/1742-6596/694/1/012062

Selepas Bersalin Di Malaysia - Google Search, Sumethokula, P., Patwary, A. K., Srinuanpanc, B., Srinuanpand, C., Suwandee, P., Thammathikulf, A., & Phanong, W. (2020). The potential of new tour repackaging for creative tourism among entrepreneurs in Nakhon Si Thammarat. *International Journal of Innovation, Creativity and Change*, 13(10), 1752-1771.

UiTM di. "Perbezaan Antara Kajian Kuantitatif Dan Kualitatif." Made in UiTM, 9 Oct. 2017, [madeinuitm.com/perbezaan-antara-kajian-kuantitatif-dan-kualitatif](http://madeinuitm.com/perbezaan-antara-kajian-kuantitatif-dan-kualitatif).

WikiHow. (2022). How to Analyse Data Using SPSS: 6 Steps (with Pictures) - wikiHow. [wikiHow. https://www.wikihow.com/Analyse-Data-Using-SPSS](https://www.wikihow.com/Analyse-Data-Using-SPSS)

Wu, B., Liu, S., Wang, J., Tahir, S., & Patwary, A. K. (2021). Assessing the mechanism of energy efficiency and energy poverty alleviation based on environmental regulation policy measures. *Environmental Science and Pollution Research*, 28, 40858-40870.

Wu, B., Zhai, B., Mu, H., Peng, X., Wang, C., & Patwary, A. K. (2021). Evaluating an economic application of renewable generated hydrogen: A way forward for green economic performance and policy measures. *Environmental Science and Pollution Research*, 1-15.

[www.google.com/search?q=statistik+kemurungan+selepas+bersalin+di+malaysia&sxr=ALiCzsZU-](http://www.google.com/search?q=statistik+kemurungan+selepas+bersalin+di+malaysia&sxr=ALiCzsZU-). Accessed 6 Jan. 2023.

Zach. (2022, May 3). *What is Reliability Analysis? (Definition & Example)*. Statology. <https://www.statology.org/reliability-analysis/>

Zikmund, W. G. (2003). *Basic Data Analysis: Descriptive Statistic*. Health Economics Research Method, 1.

Zikmund, W. G. (2003). *Basic Data Analysis: Descriptive. Research Methods (7th ed.)* SouthWestern, Ohio.

# THE EFFECT OF ONLINE GAMING ON MENTAL HEALTH, FINANCE AND ACADEMIC PERFORMANCE AMONG UNIVERSITY STUDENT

*Mohamad Dhoiyaul Mukmin Al-Muiynuddin Bin Berhim, Najah Binti Mohd Yusof and*

*Nor Hazwani Binti Anur*

*Faculty of Hospitality, Tourism and Wellness, Universiti Malaysia Kelantan*

*Corresponding email:*

---

## ABSTRACT

Online gaming refers to the activity of playing video games over the internet either with or against other players. It involves connecting to a server or game platform using a computer or mobile device with an internet connection. Online gaming has grown significantly with the advancement of technology and the popularity of multiplayer games. Online games go beyond entertainment and leisure. It has become an important aspect of modern game culture and has created new avenues for social interaction, communication and collaboration. The purpose of this study is to examine the relationship between online games and mental health, finances and academic performance among university students. The main objective of this study is the effect online gaming on mental health, finance and academic performance among university students. This study has used quantitative methods to achieve the main objective of the study. Researchers have used Google Form to survey the questionnaire which contains 3 parts to 384 respondents. SPSS, or the Statistical Package for Social Science, was used to compile and analyse the data. For better performance and decision-making, SPSS handles the complete statistical analysis process, including planning, data collection, analysis, and reporting. This study examined the impact of online games on university students' mental health, financial situation, and academic achievement using Pearson's coefficient. The study's findings demonstrate the close connection between students' academic performance, financial stability, and mental health. This study examined the impact of online games on university students' mental health, financial situation, and academic achievement using Pearson's coefficient. The results of the study show the strength of the relationship on mental health, finances and academic performance among students.

**Keywords:** Online games among university students, mental health, finance and academic performance

---

## **INTRODUCTION**

Online gaming is an electronic game played over a network of computer and smartphones especially over the internet. Addicting to online gaming are now becoming more serious and worrying especially among students.

## **PROBLEM STATEMENT**

### **Mental Health**

According to Ahmad Farid (2021), the effects of video games had an impact on mental health. For example, A young man murdered a woman purely for the purpose of killing in the real world. All of this can be attributed to the effects of violent video games. Roshlawaty Md. Raieh (2021) has found that those who are addicted to mobile gaming are more likely to face depression, anxiety, and loneliness.

### **Finance**

The phenomenon of playing video games also causes students to become excessively addicted to online games. This demonstrates that they spent a significant amount of time each day with smartphones and laptop computers. Maulana Ramadhan (2021) said that a young man in Mumbai, India, had spent 10 lakh rupees of his mother's bank savings online gaming.

### **Academic Performance**

According to The Inspirasi (2021), students are more likely to spend time playing online games than reviewing learning. Playing video games for hours has affected my performance as a student. Studies show that more time spent playing games on the screen can be linked to lower academic performance



## SIGNIFICANCE OF THE STUDY

### LITERATURE REVIEW

#### Research Framework

#### Independent Variable

#### Dependent Variable

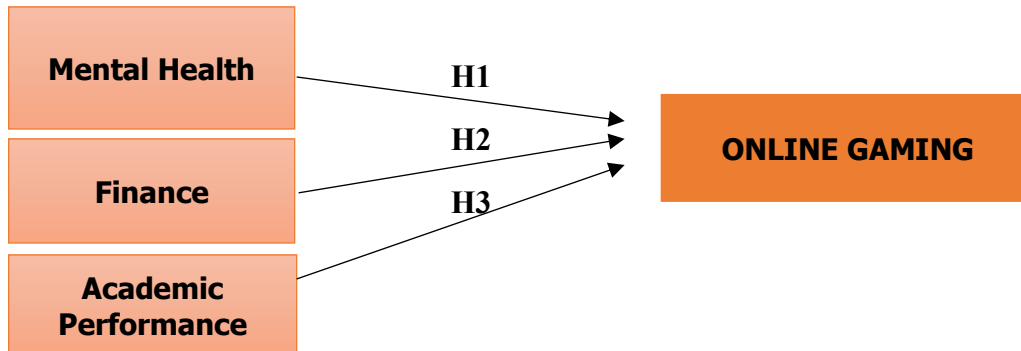

### METHODOLOGY

#### Research Design

For this study, the quantitative methods are selected to study the effect of online gaming on mental health, finance, and education among university students. Quantitative research uses systematic and simple to grasp data collection methods to demonstrate how variables can be assessed through observation and coding, for instance.

#### Population

The term "population" describes the complete group of people, activities, or objects of interest that researchers will be analysing (Kumar, 2011). Local Malaysian students make up the study's population. In this study, IPTA students in Malaysia are the main subjects.

#### Sample Size

In this study, the sample size is 384 respondents that student who playing online gaming.

#### Data Collection

Primary data & secondary data

Survey questionnaire is online survey (Google Form)

## Sampling Method

The probability sampling method is used. The objective when selecting a probability sample design is to save survey time and expense while simultaneously minimising the sampling error of the most crucial survey variables.

## Research Instrument

Online questionnaire is undertaken to save costs and simplify the work of researchers. The created questionnaire has three part that respondents must complete.

In this study we use a likert.

## Data Analysis

Descriptive Analysis

Reliability Test

Pearson Correlation

## FINDINGS

### RESULT

	Hypothesis	Person correlation result	
H1	A positive hypothesis exists between the online gaming with mental health	( $r = .482^{**}$ , $p < .000$ )	Supported
H2	A positive hypothesis exists between the online gaming with finance	( $r = .365^{**}$ , $p < .000$ )	Supported
H3	A positive hypothesis exists between the online gaming with education performance	( $r = .380^{**}$ , $p < .000$ )	Supported

## **DISCUSSION AND RECOMMENDATION**

### **H1 - Relationship between Online Gaming and mental health among university students**

To respond to RQ1, the findings of Hypothesis H1 in Chapter 4 were evaluated. According to H1, there is a considerable connection between online gaming and students' mental health. The results demonstrate a positively significant correlation coefficient value of.482\*\*, while a p-value of.000, which is below the highly significant level of.001, is also present. H1 was therefore approved.

### **H2 - Relationship between online gaming and finance among university students**

In order to address research question 2 (RQ2), the findings of hypothesis H2 in Chapter 4 were reviewed. The results demonstrate a strongly positive connection with a coefficient value of.385\*\*. The p-value for financial online gambling among college students is.000, which is lower than the significant level of.001. As a result, there is a considerable correlation between the impact of online gaming and student finances. H2 was approved as a result.

### **H3 - Relationship between online gaming and academic performance among university students**

The research question 3 (RQ3) from the previous chapter will be in line with the hypothesis (H3) depending on the outcome of the data analysis. Based on the findings, there is a moderately positive association between online gaming and academic achievement among university students, with a correlation coefficient of.380\*\*. According to the findings, academic success among university students is favourable and strongly correlated with travel happiness.

## **RECOMMENDATION**

Using both qualitative and quantitative techniques will improve the effectiveness of this investigation. This is because it can assist researchers in conducting future studies that are more precise and of higher quality.

Distribute survey questionnaires in a more official manner if they are distributed online. In addition, a letter of approval from the university or superiors is required along with the questionnaires in order to perform the study.

Additionally, the researcher might narrow the scope of the target respondent or find a more focused respondent.

Maintain a balanced lifestyle by engaging in a variety of activities beyond gaming to promote a balanced lifestyle. Pursue other hobbies, engage in physical exercise, spend time with friends and family, and participate in academic and extracurricular activities.

## **CONCLUSION**

In conclusion, this study has been carried out to explore the effect of online gaming on mental health, finances, and academic performance among university students. The reviewed literature is used to develop the conceptual framework. The relationship between these independent variables and the dependent variables was the subject of the study. The overall variable for the reliability analysis result is 0.966. Additionally, the outcome is credible and appropriate for this study. The goal of the study is to understand how university students' academic achievement, financial stability, and mental health are related to online gaming. The result of the research objectives, which is the relationship between online gaming and mental health, finances, and academic performance among university students, is accepted.

## REFERENCES

- Admin. (2017). Primary Data Collection Methods | needs survey & types.
- Akter, M., Sadekin, M. N., & Patwary, A. K. (2020). An Empirical Study on Students' Satisfaction from Mawlana Bhashani Science & Technology University, Bangladesh. *Review of Economics and Development Studies*, 6(2), 363-379.
- Alom, S., Patwary, A. K., & Khan, M. M. H. (2019). Factors affecting the turnover intention of Bangladeshi migrants in the United Arab Emirates: An empirical study on the hotel industry. *International Journal of Innovation, Creativity and Change*, 8(3), 344-360.
- Bush, T. (2020). Descriptive Analysis: How-To, Types, Examples. *PESTLE ANALYSIS*.
- Daniel Kane, B. D. (1998). Recognizing ESports as a Sport. *The Sport Journal*.
- Donald R. Cooper and Pamela S. Schindler. (2011). What size sample is needed? In *Business Research Methods* (p. 374). McGraw-Hill/Irwin.
- Facette, F. F. (2023, January 8). JawaPosCom. Retrieved from Secara Tak Sadar, Game Online Jadi Salah Satu Penyebab Kemiskinan: <https://www.jawapos.com/ekonomi/bisnis/06/01/2018/secara-tak-sadar-game-online-jadi-salah-satu-penyebab-kemiskinan/?amp>
- Fengmin, Z., Baijun, W., Jiangtao, B., Li, L., & Patwary, A. K. (2022). Investigating revisit intention of medical tourists in China through nutritional knowledge, perceived medical quality, and trust in the physiologist: A recommendation on health tourism policy measures. *Frontiers in Public Health*, 10, 893497.
- Hazbar, A. M. H., Alem Mohammed, A., & Karim, A. K. A. (2019). An Empirical Study of Factors Influencing hotel customers' online booking Intention. *مجلة العلوم التربوية و الدراسات الإنسانية*, (5), 1-17.
- Hox, J. &. (2005). Data Collection, Primary versus Secondary. 593-599.
- Kuss, D. &. (2012). Online Gaming addiction in adolescence: A literature review of empirical research. *Journal of Behavioural Addiction*, 1, 3-22. 3-22.
- Li, L., Ragavan, N. A., Patwary, A. K., & Baijun, W. (2022). Measuring patients' satisfaction toward health tourism in Malaysia through hospital environment, nutritional advice, and perceived value: A study on Chinese exchange students. *Frontiers in public health*, 10, 893439.
- Li, L., Wu, B., & Patwary, A. K. (2022). How marine tourism promote financial development in sustainable economy: new evidences from South Asia and implications to future tourism students. *Environmental Science and Pollution Research*, 29, 1155-1172.
- Li, L., Wu, B., & Patwary, A. K. (2022). The psychosocial factors affecting chinese Outbound Exchange and mobility students' academic performance during COVID-19. *Frontiers in psychology*, 13, 872516.

- Likert, R. (1932). A technique for the Measurement of Attitudes. *Archives of Psychology*, 140, 55.
- Máté Smohai, R. U. (2017). Online and offline video game use in adolescents: measurement invariance and problem severity. *The American Journal of Drug and Alcohol Abuse*, 43:1, 111-116.
- Mukesh Kumar, S. A. (2012). Scientific Research and Research Process. In S. A. Mukesh Kumar, *Business Research Methods* (p. 100). Business: Oxford Fajar Sdn. Bhd.
- Patwary, A. K., Roy, B., Hoque, R., & Khandakar, M. S. A. (2019). Process of developing a community based tourism and identifying its economic and social impacts: An Empirical study on Cox's Bazar, Bangladesh. *Pakistan Journal of Humanities and Social Sciences*, 7(1), 1-13.
- Qaisar, S. (2021, Desember 16). TeachBead. Retrieved from <https://www.techbead.com/positive-and-negative-effects-of-online-gaming/>
- Sidik, P. D. (2020). Ketagihan Permainan Video (Video Game) Dan Kesehatan Mental Pelajar.
- Sumethokula, P., Patwary, A. K., Srinuanpanc, B., Srinuanpand, C., Suwandee, P., Thammathikul, A., & Phanong, W. (2020). The potential of new tour repackaging for creative tourism among entrepreneurs in Nakhon Si Thammarat. *International Journal of Innovation, Creativity and Change*, 13(10), 1752-1771.
- Team, I. E. (2022, 4 28). 54 Ways To Say "It Was a Pleasure Working With You". Retrieved from <https://www.indeed.com/career-advice/career-development/pleasure-working-with-you>
- TheInspirasi. (2021). Ketagihan Permainan Atas Talian Membawa Padah! Ye, J. (2016, SEPTEMBER 14). Retrieved from <https://www.scmp.com/news/hong-kong/education-community/article/2019271/study-ranks-hong-kong-no-3-asia-english-trailing>:
- Wu, B., Liu, S., Wang, J., Tahir, S., & Patwary, A. K. (2021). Assessing the mechanism of energy efficiency and energy poverty alleviation based on environmental regulation policy measures. *Environmental Science and Pollution Research*, 28, 40858-40870.
- Wu, B., Zhai, B., Mu, H., Peng, X., Wang, C., & Patwary, A. K. (2021). Evaluating an economic application of renewable generated hydrogen: A way forward for green economic performance and policy measures. *Environmental Science and Pollution Research*, 1-15.

# THE FACTORS INFLUENCING NURSES MENTAL HEALTH IN HOSPITAL RAJA PEREMPUAN ZAINAB II (HRPZ II)

**Nur Ain Hakimah Binti Kamal, Nur Ain Solehah Binti Ghazali, Nur Athirah Binti Azman, Mohamad Faizhan Bin Mohd Fauzi, Norsyamlina Binti Che Abdul Rahim\***

*Faculty Hospitality, Tourism and Wellness of University Malaysia Kelantan*

*CORRESPONDING EMAIL: norsyamlina@umk.edu.my*

## **ABSTRACT**

Nursing staff job procedures have been connected to emotions of worry, sadness, psychological discomfort, sleep problems, weariness, and other body ailments, all of which have a significant impact on these healthcare professionals' emotional health. The purpose of this study was to determine the effects of organization, personal problem, stress level, sleep quality, and financial issues on the mental health among nurses in HRPZ II. This was a cross-sectional descriptive study that was conducted among 104 nurses in HRPZ II. Data were obtained using online questionnaire and processed using the SPSS 26.0 software. The results showed that the majority of the respondents were not overburdened by their daily responsibilities and have good mental health. A strong culture that promotes high ethical standards can have a positive impact on employee behavioral.

**KEYWORDS:** Mental Health, Nurses, Quantitative, Workplace, HRPZ II.

## **INTRODUCTION**

The text discusses the factors impacting the mental health of nurses at Hospital Raja Perempuan Zainab (HRPZ) II. It starts with an introduction to the study's historical framework, the requirements for conducting the study, and the problem statement for the chosen topic. The purpose of this study was to determine factors influence the mental health among nurses in HRPZ. Organization, personal problem, stress level, sleep quality, and financial issues are all components of mental health issues.

### **Significance of the Study**

The importance of a study is determined by its influence and contribution to a specific field of study. This study identified a mental health gap among healthcare workers and identified coping skills that can help nurses avoid or treat mental health problems. The results can also aid future study on nurses' mental health prevention.

## LITERATURE REVIEW

Independent variable 1 (organization): An organization's strong culture was once envisioned as a unified collection of views, values, presumptions, and practices shared by the majority of its people. The degree of consistency of beliefs, values, assumptions, and practices was stressed, as well as the prevalence (or quantity) of consistent beliefs, values, assumptions, and practices among organizational members. However, some pointed out potential problems with a strong culture, such as the potential for people to place unreasonable demands on themselves and prevent them from adapting to change. Additionally, addressing work stress and psychosocial risks should be part of safety and health strategies to reduce accidents and injuries at work. Organizational weaknesses also have an impact when there is an extreme workload or conflicting tasks where there is no cooperation between other employees.

Independent variable 2 (personal problem): Direct and indirect patient care are both negatively impacted by insufficient nurse staffing. Nurse morale may deteriorate and care may not be provided in line with set standards if the correct nurse leaves and is replaced by someone unfamiliar with the routine. This may result in working with an inadequate number of nurses or putting in extra hours to cover for absent nurses, both of which can be physically and mentally taxing. Usually, substitute nurses need additional oversight, which can be costly as well as detrimental to productivity and patient care quality. Co-workers may unintentionally feel annoyed about having to take on more work or feel under pressure to put in extra hours.

Independent variable 3 (stress level): Nurses have a variety of responsibilities, including teaching, communicating, and caring. Stress is caused by work-life balance, inadequate work organization, job overload, poor management, personal issues, unsatisfactory working conditions, and poor relationships at work. It has an adverse effect on the individual and has a detrimental impact on the business as a whole. Job discontent is high for nurses.

Independent variable 4 (sleep quality): Nurses with poor mental and physical health are more likely to experience depression than those with good mental and physical health. This is due to their physical and mental frailty, which makes them feel stressed out and promotes depression. To improve the quality of nurses' sleep, it is important to pay attention to the function of cognitive and metacognitive processes. Another study revealed that those who struggle with depression would benefit from exercising.

Independent variable 5 (financial): Nurses are highly trained medical professionals who are often the first response and the last line of defense between life and death. Low pay has contributed to an unhealthy lifestyle and had a significant negative impact on nurses' relationships, connections with co-workers, and general quality of life. Financial problems can leave people feeling angry, ashamed, or afraid, and can also cause tension and disagreements with their closest friends and family. Inaction is necessary for both health and wealth, and is necessary for both social and mental wellbeing.

Dependent variable: Nursing professionals are more likely to experience mental health issues due to high-stress scenarios at work, such as severe workloads, personal issues, financial stress, a



lack of staff, team friction, and witnessing patient suffering and death. This is important because nurses play a significant influence in the 3.6 million patient fatalities and 136 million adverse events that occur each year across the globe. Reassessing and understanding the connection between nurse reported mental health and perceived safety and quality of patient care is urgently required. The prevalence of mental health issues among healthcare professionals, particularly nurses, has increased.

### Study Hypothesis

H1: There is a significant relationship between organizations and mental health among nurses at Hospital Raja Perempuan Zainab II (HRPZ II).

H2: There is a significant relationship between personal problems and mental health among nurses at Hospital Raja Perempuan Zainab II (HRPZ II).

H3: There is a significant relationship between stress level and mental health among nurses at Hospital Raja Perempuan Zainab II (HRPZ II).

H4: There is a significant relationship between sleep quality and mental health among nurses at Hospital Raja Perempuan Zainab II (HRPZ II).

H5: There is a significant relationship between financial and mental health among nurses at Hospital Raja Perempuan Zainab II (HRPZ II).

### Study Framework

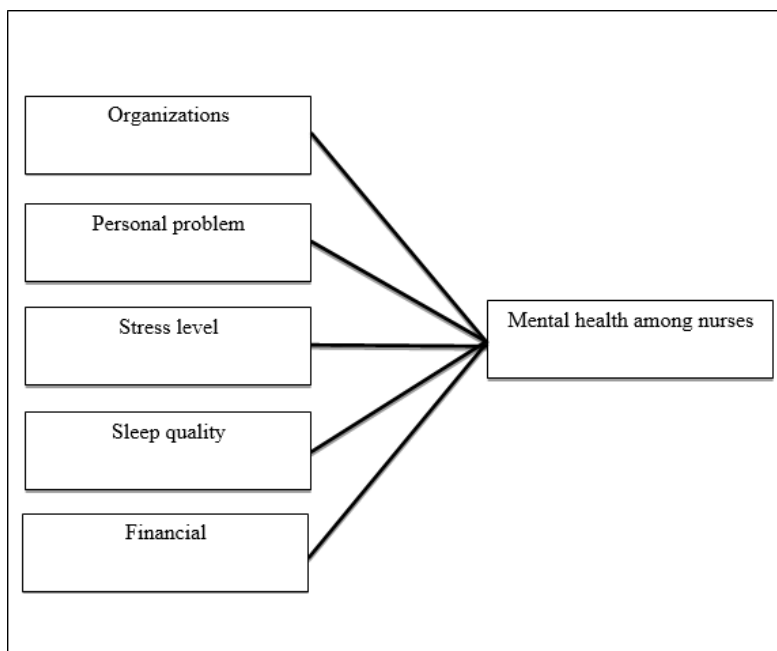

Figures 1.1

## **METHODOLOGY**

### **Study Design**

The design process of a study is to examine and gather information about generalizations in order to address the issue. This study uses quantitative study techniques such as numerical, continuous and differential data. The researchers intend to find data about the personal relationship of nurses with their service as nurses and how it leads to mental health among nurses in HRPZ II hospitals. The main categories of quantitative data are sensing, measuring, counting, quantifying, calculating, estimating and predicting.

### **Data Collection**

The data collection method is the process of collecting information for the targeted variables in an organized method. Data can be divided into main categories which are primary data and secondary data. For this research, primary data will be used, and the data collected through an online survey which is an online questionnaire. The questionnaires will be distributed to share surveys on WhatsApp randomly to the respondents who work at (HRPZ II). In this way, researchers may provide the most direct and simple technique of collecting extensive and in-depth data regarding a certain event. When deciding on the type of questions to employ to collect data, consider study questions, participant characteristics, and the researchers preferred approach.

### **Sampling**

Since there were 104 nurses total at HRPZ II, which is less than 201, the researcher's chose the entire population to serve as the sample for this study. According to Sugiyono (2007: 124), Total sampling is a method of data collection when the total sample size resembles the entire population. In order to fill out the surveys, the entire population served as the representative respondents.

Sampling is the practice of taking a representative sample from a population in order to examine the sample and ascertain its qualities or characteristics before extrapolating those traits to the complete population. There are two different types of sampling techniques. A researcher's uses the sampling method known as probability sampling to choose samples from a larger population using a method based on probability theory. A participant must be picked at random if they are to be carefully investigated as a probability sample. According to the definition given below, non-probability sampling is a sampling strategy in which samples are selected depending on the researcher's judgement rather than by chance. It assumes a more hospitable stance. This sampling technique gives the researcher's knowledge a fundamental framework. It is employed in quantitative study and mostly involves observational approaches.

## Data Analysis

Data analysis is a systematic collection of mathematical, statistical, and logical approaches that can be used to characterize the data context, modularize the data structure, condense the data representation, highlight statistical tendencies, gather useful data, and draw conclusions. By eliminating the extraneous noise that the rest of the data creates, these analytical techniques help us to get the underlying insight from the data. Data analysis is a continuous, iterative process in which data collection and analysis occur continually since data production is a continuous activity. One of the most important aspects of data analysis is data integrity.

This study made use of the Statistical Package for Social Science (SPSS). A group of software applications have been compiled into a single package called SPSS. The study of scientific evidence in social science is the main application of this curriculum. Data analysis, surveys, and marketing strategy may all benefit from this information. Studiers may swiftly comprehend market demand for a product using the statistical data they have obtained and change their strategy.

## FINDINGS

Demographic	Categories	Frequency (n)	Percentage (%)
<b>Gender</b>	Male	39	37.5
	Female	65	62.5
<b>Age</b>	18 – 21 years old	8	7.7
	22 – 25 years old	28	26.9
	26 – 29 years old	33	31.7
	30 years old and above	35	33.7
<b>Marital Status</b>	Single	47	45.2
	Married	57	54.8

Demographic	Categories	Frequency (n)	Percentage (%)
<b>Race</b>	Malay Chinese	80	76.9
	Indian Iban	15	14.4
		8	7.7
		1	1.0
<b>Religion</b>	Muslim Buddha	82	78.8
	Christian	13	12.5
		9	8.7

The table displays the gender distribution of the respondents based on the results from the table. There are 104 responders in all. In this survey, there were more female respondents than male respondents, with 62.5% (n=65) respondents as opposed to 37.5% (n=39).

Table displays the distribution of ages. Four age categories were assigned to the respondents. With 33.7% (n=35) of the total respondents, the group of respondents aged 30 and older had the greatest response rate, followed by the group of respondents aged 26 to 29 who had 31.7% (n=33) of the total respondents. With 26.9% (n=28) respondents, the 22–25 age group is the third-highest group, followed by the 18–21 age group with 7.7% (n=8) respondents.

The marital status of the respondents is shown in the table. The percentage of married nurses is 54.8% (n=57) responders. In the meanwhile, 47 respondents, or 45.2%, reported being single.

The table shows how respondents were distributed by race. Malay respondents made up 76.9% of the survey's total (n=80), while Chinese respondents came in second with 14.4% (n=15). Indians are the third most prevalent group race, with 7.7% (n=8) respondents, followed by Iban with 1.0% (n=1) respondents.

The table also displays the respondent's religion as a percentage. Muslim respondents make up 78.8% of the total (n=82), while Buddhist respondents make up 12.5% (n=13). Last but not least, Christian had the lowest response rate (8.7%; n=9).

## RESULT OF DESCRIPTIVE ANALYSIS

The 104 nurses working at Hospital Raja Perempuan Zainab II who responded to the survey are shown in the table below along with the mean and standard deviation for each variable.

### Organization

Descriptive statistics of Organization

Variables	N	Mean	Standard Deviation
Do you work according to a set schedule?	104	3.41	1.391
You often work overtime in a month.	104	3.50	1.215
There are still nurses doing other people's work.	104	3.69	1.175

The mean and standard deviation statistics of the responses to the organization are displayed in the table. The organizational element "there are still nurses doing other people's work" had the highest mean value, 3.69, and the respondents strongly agreed that it had contributed to the mental health issues of the nursing staff at HRPZ II. The question "do you work according to a set schedule?" had the lowest mean, with a mean value of 3.41, and respondents strongly agreed that this organizational feature has contributed to respondents' mental health issues. The respondents' impartial agreement that "you often work overtime in a month" can affect nurses' mental health was represented by a mean value of 3.50 for the statement. Additionally, the diversity of "Do you work according to a set schedule?" has a greater standard deviation of 1.391. Greater data dispersion is indicated by higher standard deviation values. In light of these criteria, respondents have provided information.

## Personal Problem

Descriptive statistics of Personal Problem

Variables	N	Mean	Standard Deviation
Most nurses will have conflicts with co-workers or family members.	104	3.32	1.264
Living far away from work places a high workload on you.	104	3.89	1.131
A less conducive environment at work will disturb your emotions while working.	104	3.85	1.189

The respondents' mean and standard deviation data for the personal problem are shown in the table. Living far from work throws a severe workload on you, and respondents strongly agreed that this has contributed to mental health issues among nurses. This statement had the highest mean value, which was 3.89. The respondents lukewarmly agreed that personal issues of "most nurses will have conflicts with co-workers or family members" might lead to mental health, while the lowest mean was "most nurses will have conflicts with co-workers or family members" with a mean value of 3.32. Additionally, the phrase "a less conducive environment at work will disturb your emotions while working" had a mean score of 3.85, indicating that respondents are gradually coming to believe that this phrase can cause nurses to encounter mental health issues. Additionally, "most nurses will have conflicts with coworkers or family members" has a greater standard deviation of 1.264. The wider range of the data is indicated by a higher standard deviation number.

## Stress Level

Descriptive statistics of Stress Level

Variables	N	Mean	Standard Deviation
Job stress can affect your physical and psychological health.	104	3.93	1.176
Stress can reduce your organizational productivity and job satisfaction.	104	3.79	1.228
The patient's irrational behaviour can affect your performance.	104	3.63	1.166
Excessive work stress that occurs in the workplace can cause chronic health problems.	104	3.71	1.188
Stress can affect productivity and impact productivity in your workplace.	104	3.88	1.160

The respondents' mean and standard deviation data for their degree of stress are shown in the table. The respondents highly agreed that "job stress can affect your physical and psychological health" has caused the nurses to experience mental health, and this significantly correlated with the statement's highest mean value, which was 3.93. The respondents agreed that the stress level of "the patient's irrational behaviour can affect your performance" can only mildly harm respondents' mental health, while the lowest mean was "the patient's irrational behaviour can affect your performance," with a mean value of 3.63. Additionally, the statement "stress can lower your organizational productivity and job satisfaction" had a greater standard deviation of 1.228. The wider range of the data is indicated by a higher standard deviation number. The higher standard deviation value indicates the greater spread in the data.

## Sleep Quality

Descriptive statistics of Sleep Quality

Variables	N	Mean	Standard Deviation
Less of sleep can affects your quality of life and work productivity.	104	3.87	1.315
Nursing is an occupational that is more prone to insufficient sleep quality.	104	3.81	1.231

The respondents' mean and standard deviation data for sleep quality are shown in the table. The biggest mean score for the statement "Less of sleep can affects your quality of life and work productivity" was 3.87, and the respondents overwhelmingly agreed that poor sleep quality can harm nurses' mental health. Meanwhile, the lowest mean "nursing is an occupational that is more prone to insufficient sleep quality" with a mean value of 3.81, where the respondents agreed that sleep quality of "nursing is an occupational that is more prone to insufficient sleep quality" can led the nurses to experience the mental health. In addition, the larger standard deviation 1.315 was "less sleep can affect your quality of life and work productivity". The wider range of the data is indicated by a higher standard deviation number.

## Financial

Descriptive statistics of Financial

Variables	N	Mean	Standard Deviation
You are satisfied with your current salary.	104	3.09	1.337
Your current salary enough to support you and your family.	104	3.24	1.273
You will change your career as a nurse if the salary earned is not satisfactory.	104	3.33	1.265



The financial survey respondents' mean and standard deviation data are shown in the table. The response "You will change your career as a nurse if the salary earned is not satisfactory" had the highest mean value, 3.33, and the respondents strongly agreed that financial factors were the ones that had the most of an impact on the mental health of the nurses in HRPZ II. The respondents agreed that financial circumstances related to "you are satisfied with your current salary" might affect nurses' mental health, whereas the lowest mean was "you are satisfied with your current salary," with a mean value of 3.09. Additionally, "you are satisfied with your current salary" had a greater standard deviation of 1.337. The wider range of the data is indicated by a higher standard deviation number.

## Mental Health

Descriptive statistics of Mental Health

Variables	N	Mean	Standard Deviation
Mental health issue are common among you.	104	4.41	0.705
Your productivity at work will suffer if you suffer from mental health problems.	104	4.36	0.749
Increased awareness of mental health will impact and help your health	104	4.17	0.830

The respondents' mean and standard deviation data for mental health are shown in the table. The respondents firmly agreed that the mental health of "mental health issue is common among you" lead the mental health among the nurses in HRPZ II. "Mental health issue are common among you" recorded the highest mean value, which was 4.41. The respondents agreed that mental health factors of "increased awareness of mental health will impact and help your health" can cause nurses to experience the mental health, while the lowest mean was "increased awareness of mental health will impact and help your health," with a mean value of 4.17. Additionally, the greater standard deviation, which was 0.830, is "increased awareness of mental health will impact and help your health". The wider range of the data is indicated by a higher standard deviation number.

## Dependent and Independent Descriptive

Dependent and independent variable

Variables	N	Mean	Standard Deviation
Organization	104	3.53	0.943
Personal Problem	104	3.69	1.023
Stress Level	104	3.79	1.022
Sleep Quality	104	3.84	1.171
Financial	104	3.22	1.075
Mental Health	104	4.31	0.614

The independent variables (IV) and dependent variable (DV) mean, standard deviation, and number of respondents are all displayed in the table. The mean score for the independent variables (IV) for sleep quality was 3.84, followed by stress level (3.79), personal issue (3.69), organisation (3.53), and money (3.22). The mental health dependent variable's (DV) mean score is 4.31.

The biggest standard deviation among the independent variables (IV) is for sleep quality, with a value of 1.171, followed by finances (1.075), personal issues (1.023), stress levels (1.022), and organisation (0.943). The mental health of the dependent variable (DV) has a standard deviation of 0.614.

## DISCUSSION AND RECOMMENDATION

### Discussion

#### Research Objective 1 & Research Question 1

Research Objectives (RO)	Research Question (RQ)
To identify the relationship of organizations on mental health among nurses in HRPZ II.	What is the relationship between organizations and mental health among the nurses in HRPZ II?
H1: There is a significant relationship between organizations and mental health among nurses at Hospital Raja Perempuan Zainab II (HRPZ II).	

To respond to research question 1, the findings of hypothesis H1 in the preceding chapter were examined. Additionally, according to H1 (HRPZ II), there is a tenuous link between organisational performance and staff nurses' mental health. With a correlation value of 0.372, the study's results demonstrate that organisation among hospital nurses is beneficial and unrelated to mental health. Additionally, there is no correlation between organisational structure and nurses' mental health at HRPZ II. H1 is therefore rejected.

#### Research Objective 2 & Research Question 2

Research Objectives (RO)	Research Question (RQ)
To determine the relationship of personal problems to mental health among nurses in HRPZ II.	Is there any relationship between personal problems and mental health among nurses in HRPZ II?
H2: There is a significant relationship between personal problems and mental health among nurses at Hospital Raja Perempuan Zainab II (HRPZ II).	

To address research question 2, the conclusion of hypothesis H2 in the preceding chapter was evaluated. In addition, according to H2, there is a connection between individual issues and nurses' mental health at Hospital Raja Perempuan Zainab II (HRPZ II). According to the results, personal issues among nurses at Hospital Raja Perempuan Zainab II (HRPZ II) are beneficial and unrelated to mental health, with a correlation value of 0.310. Additionally, there is no connection between nurses' personal issues and their mental health at Hospital Raja Perempuan Zainab II (HRPZ II). Therefore, H2 rejected.

Research Objective 3 & Research Question 3

Research Objectives (RO)	Research Question (RQ)
To identify the effect of stress level on mental health nurses in HRPZ II.	Does there any effect of stress level on mental health among nurses in HRPZ II
H3: There is a significant relationship between stress level and mental health among nurses at Hospital Raja Perempuan Zainab II (HRPZ II).	

To address research question 3, the outcome of hypothesis H3 in the preceding chapter was evaluated. In addition, H3 reported that stress levels and nurses' mental health at Hospital Raja Perempuan Zainab II are related. The results demonstrate that among nurses in HRPZ II, stress level is positive and unrelated to mental health, with a correlation value of 0.413. Additionally, there is no connection between nurses' mental health and their sleep quality in HRPZ II. Therefore, H3 are not significant and rejected.

Research Objective 4 & Research Question 4

Research Objectives (RO)	Research Question (RQ)
To examine the relationship between quality of sleeping and mental health among nurses in HRPZ II.	Is there any relationship between quality of sleeping and mental health among nurses in HRPZ II?
H4: There is a significant relationship between sleep quality and mental health among nurses at Hospital Raja Perempuan Zainab II (HRPZ II).	

To address research question 4, the conclusion of hypothesis H4 in the preceding chapter was evaluated. Additionally, according to H4, there is a connection between nurses' mental health and the quality of their sleep at Hospital Raja Perempuan Zainab II. With a correlation value of 0.358, the results demonstrate that sleep quality is good and unrelated to mental health among nurses in HRPZ II. Additionally, among nurses in HRPZ II, there is no connection between sleep quality and mental health. Therefore, H4 are not significant and rejected.

## Research Objective 5 & Research Question 5

Research Objectives (RO)	Research Question (RQ)
To identify the effect of financial to mental health among nurses in HRPZ II	What is the relationship between financial and mental health among the nurses in HRPZ II?
H5: There is a significant relationship between financial and mental health among nurses at Hospital Raja Perempuan Zainab II (HRPZ II).	

To address research question 5, the outcome of hypothesis H5 in the preceding chapter was evaluated. In addition, H5 reported that in Hospital Raja Perempuan Zainab II, there is a connection between financial stability and nurses' mental health. According to the results, financial status among nurses in HRPZ II is favorable and unrelated to mental health, with a correlation value of 0.196. Furthermore, among nurses in HRPZ II, there is no connection between financial status and mental health. Therefore, H5 are not significant and rejected.

### Recommendation

Studying the factors influencing nurses' mental health is crucial as it directly impacts their ability to provide quality care and job satisfaction. Future research should focus on job stress, workplace environment, work-life balance, social support systems, technology, and workload. Job stressors, such as high workload, emotional demands, lack of control, organizational culture, and interprofessional conflict, can contribute to nurses' mental health issues, such as fatigue, anxiety, depression, and job satisfaction. Work-life balance should be emphasized, with factors such as flexible schedules, family support, childcare arrangements, and availability of time off affecting nurses' ability to manage stress and maintain a healthy work-life balance. Social support systems, such as peer support programs, mentoring, and counseling services, can also help reduce stress and promote mental well-being.

Technology implementation, such as electronic health records and digital documentation systems, should also be investigated to assess the impact of increased workload, information overload, and blurring of work-life boundaries due to technological advances. These recommendations provide a starting point for future research in understanding the factors influencing nurses' mental health, allowing for the development of evidence-based strategies and interventions to improve the quality of healthcare delivery.

## **CONCLUSION**

This study explores how HRPZ II nurses can operate more effectively. It defines the words "mental health", "organization", "personal problems", "sleep quality", "financial status", and "stress levels". The study questions and objectives relate to mental health as the dependent variable and personal difficulties, sleep quality, finances, and stress levels as the independent variables. The definition of words is discussed last, and a summary of how the researcher's determined the value of the programmed created to increase nurses' awareness of how to deal with mental health difficulties follows.

## REFERENCES

- Akter, M., Sadekin, M. N., & Patwary, A. K. (2020). An Empirical Study on Students' Satisfaction from Mawlana Bhashani Science & Technology University, Bangladesh. *Review of Economics and Development Studies*, 6(2), 363-379.
- Alom, S., Patwary, A. K., & Khan, M. M. H. (2019). Factors affecting the turnover intention of Bangladeshi migrants in the United Arab Emirates: An empirical study on the hotel industry. *International Journal of Innovation, Creativity and Change*, 8(3), 344-360.
- Bitstream. (n.d.). *Bitstream*. Retrieved from Chapter 3 Study methodology: <https://uir.unisa.ac.za/bitstream/handle/10500/1899/03chapter3.pdf>
- Chizuko Takahashi, F. C. (2011). The impact of inpatient suicide on psychiatric nurses and their need for support. *BMC Psychiatry*, No. 38.
- Emilia Zainal Abidin, I. N. (2007). Work-related stress and coping: A Survey on Medical and Surgical nurses in a Malaysian teaching hospital. *Studygate*.
- Farinaz Havaei, X. T. (2021). The Association between Mental Health Symptoms and Quality and Safety of Patient Care before and during COVID-19 among Canadian Nurses. *Healthcare*.
- Fengmin, Z., Baijun, W., Jiangtao, B., Li, L., & Patwary, A. K. (2022). Investigating revisit intention of medical tourists in China through nutritional knowledge, perceived medical quality, and trust in the physiologist: A recommendation on health tourism policy measures. *Frontiers in Public Health*, 10, 893497.
- Fleetwood, D. (2018, 11 13). *Question Pro*. Retrieved from Sampling Methods: Types with Examples: <https://www.questionpro.com/blog/types-of-sampling-for-social-study/>
- Hazbar, A. M. H., Alem Mohammed, A., & Karim, A. K. A. (2019). An Empirical Study of Factors Influencing hotel customers' online booking Intention. *مجلة العلوم التربوية و الدراسات الإنسانية*, (5), 1-17.
- Hill, K. S.-B. (2011). Work Satisfaction, Intent to Stay, Desires of Nurses, and Financial Knowledge Among Bedside and Advanced Practice Nurses. *The Journal Of Nursing Administration*, Vol 41, No 5, pages 211-217.
- International Council of Nurses*. (Adopted in 1995). Retrieved from Mental Health: [https://www.icn.ch/sites/default/files/inline-files/PS\\_A\\_Mental%20Health\\_0.pdf](https://www.icn.ch/sites/default/files/inline-files/PS_A_Mental%20Health_0.pdf)
- Ishtiaq, M. (2019). Creswell, J. W. (2014). *Study Design: Qualitative, Quantitative and Mixed Methods Approaches* (4th ed.). Thousand Oaks, CA: Sage. *Academia*.
- Jablonski, K. (2022). Personal issues impacting the workplace. *International Bar Association. JB Medical* . (2022, 05 11). Retrieved from What Are The Biggest Risks of Mental Health Nursing?: <https://jbmedical.com.au/what-are-the-biggest-risks-of-mental-health-nursing/>
- Jonathan M. Mwanja, T. M. (2017). THE INFLUENCE OF TEACHING AND
- Khatony, A., Zakiei, A., Khazaie, H., Rezaei, M., & Janatolmakan, M. (2020). A Study of Sleep Quality Among Nurses and Its Correlation With Cognitive Factors. *Nursing Administration Quarterly*, Vol 44, No 1, Pages E1-E10.
- Laura Chandler, C. P. (2022). Improving university students' mental health using multi-component and single-component sleep interventions: A systematic review and meta-analysis. *ScienceDirect*, Vol 100, Pages 354-363.
- LEARNING RESOURCES ON . *European Journal of Education Studies*, Vol 3, Issues 11.

- Li, L., Ragavan, N. A., Patwary, A. K., & Baijun, W. (2022). Measuring patients' satisfaction toward health tourism in Malaysia through hospital environment, nutritional advice, and perceived value: A study on Chinese exchange students. *Frontiers in public health*, 10, 893439.
- Li, L., Wu, B., & Patwary, A. K. (2022). How marine tourism promote financial development in sustainable economy: new evidences from South Asia and implications to future tourism students. *Environmental Science and Pollution Research*, 29, 1155-1172.
- Li, L., Wu, B., & Patwary, A. K. (2022). The psychosocial factors affecting chinese Outbound Exchange and mobility students' academic performance during COVID-19. *Frontiers in psychology*, 13, 872516.
- McCombes, S. (2019, 09 19). *Scribbr*. Retrieved from Sampling Methods | Types, Techniques & Examples: <https://www.scribbr.com/methodology/sampling-methods/>
- Miscom, Z. (2022). Jururawat terlalu banyak bekerja, kurang gaji dan tidak dihargai.
- Muhammad Habiburrahman, E. L. (2021). The Impact of Sleep Deprivation on Work Performance towards Night-shift Healthcare Workers: An Evidence-based Case Report. *Acta Medica Philippina The National Health Science Journal*, Vol 55 No 6.
- Pan American Health Organization and WHO. (2007). Retrieved from Mental Health: [https://www.paho.org/en/topics/mental-health#:~:text=The%20World%20Health%20Organization%20\(WHO,to%20his](https://www.paho.org/en/topics/mental-health#:~:text=The%20World%20Health%20Organization%20(WHO,to%20his)
- Parul Sharma, A. D. (2014). Occupational stress among staff nurses: Controlling the risk to health. *Indian Journal of Occupational & Environmental Medicine* , Vol 18, No 2, Pages 52-56.
- Patwary, A. K., Roy, B., Hoque, R., & Khandakar, M. S. A. (2019). Process of developing a community based tourism and identifying its economic and social impacts: An Empirical study on Cox's Bazar, Bangladesh. *Pakistan Journal of Humanities and Social Sciences*, 7(1), 1-13.
- Psychology, A. D. (2022, 09). *American Psychological Association*. Retrieved fromMental health: <https://www.apa.org/topics/mental-health>
- Ramli, A. A. (2018). Stress Among Nurses: A Case Study At Healthcare Centers InMelaka. *European Proceedings*.
- Soomin Ryu, L. F. (2022). The Relationship Between Financial Worries and Psychological Distress Among U.S. Adults. *Nature Public Health Emergency Collection* , 1-18.
- Sumethokula, P., Patwary, A. K., Srinuanpanc, B., Srinuanpand, C., Suwandee, P., Thammathikul, A., & Phanong, W. (2020). The potential of new tour repackaging for creative tourism among entrepreneurs in Nakhon Si Thammarat. *International Journal of Innovation, Creativity and Change*, 13(10), 1752-1771.
- Tarsi, K. (2012). *The Nature Education Knowledge Poject* . Retrieved from Introduction to Population Demographics: <https://www.nature.com/scitable/knowledge/library/introduction-to-population-demographics-83032908/>
- Team, I. E. (2021). 8 Challenges as a Nurse and Tips for Overcoming Them. *Indeed*. Tuovila, A. (2020, 05 28). *Investopedia*. Retrieved from Sampling: What It Is, Different Types, and How Auditors and Marketers Use It: *Universitas Muhammadiyah Malang* . (n.d.). Retrieved from CHAPTER III StudyMethodology.



- Wu, B., Liu, S., Wang, J., Tahir, S., & Patwary, A. K. (2021). Assessing the mechanism of energy efficiency and energy poverty alleviation based on environmental regulation policy measures. *Environmental Science and Pollution Research*, 28, 40858-40870.
- Wu, B., Zhai, B., Mu, H., Peng, X., Wang, C., & Patwary, A. K. (2021). Evaluating an economic application of renewable generated hydrogen: A way forward for green economic performance and policy measures. *Environmental Science and Pollution Research*, 1-15

# FAST FOOD CONSUMPTION AMONG TEENAGERS IN PENKALAN CHEPA

**Azra Malisa Binti Zakri, Farhanah Binti Hilmi, Nur Athirah Binti Hasham Khan,  
Muhammad Hafiz Bin Shamsuha Baharim & \* Hasif Rafidee Bin Hasbollah**

*Faculty of Hospitality, Tourism and Wellness, Universiti Malaysia Kelantan* Corresponding  
email: [rafidee@umk.edu.my](mailto:rafidee@umk.edu.my)

---

## ABSTRACT

Fast food is among the fastest-growing food categories in the world. It currently accounts for nearly half of restaurant sales in developed nations and will continue to grow there and in numerous other industrialized nations over the next few years. The most rapid expansion, however, is occurring in the poor world, where it is dramatically altering the way people consume. People purchase fast food because it is inexpensive, simple to prepare, and extensively advertised. A qualitative study was conducted to identify the factors that influence the consumption of fast food among teenagers in Pengkalan Chepa, Kelantan. The information on the respondents had gathered through 12 interviews via purposive sampling. The study indicated that personal lifestyle including trend, sleep pattern; price quality inference which is service and food quality; as well as promotion like advertising and sales promotion leads to fast-food consumption among teenagers in Pengkalan Chepa, Kota Bharu, Kelantan.

**Keywords: Fast Food, Teenagers, Personal Lifestyle, Price Quality Inference, Promotion**

---

## INTRODUCTION

Fast food is well-known for being popular, convenient for customers, tasty, and inexpensive. Today, fast food is recognized for its accessibility, efficiency, and delectability. Moreover, fast food establishments' marketing generally promotes fast food as healthy, making customers open to persuasion. According to Goyal and Singh (2007), fast food is the food sector with the most rapid growth worldwide. This may be because fast food requires immediate renewals and limited-service renewals for dining and takeout facilities. Fast food is a food that can be served and prepared quickly. Their predilection for fast food over home-cooked meals is primarily attributable to their hectic lifestyles, especially in dual-income households with children (Atkins and Bowler 2001). This was further supported by Farzana Quoquab et al. (2011), who concurred that the customers' limited time because of their long working hours, hectic lifestyle, employment, and family responsibilities. Due to the speedy preparation of meals, which enables customers to eat in a short amount of time, the fast-food industry has become the most popular option in Malaysia.

Consequently, the shifting client preferences have presented the Malaysian food industry with a chance to grow their operations. American fast-food brands such as Domino's Pizza, McDonald's, A&W, Mary Brown Kentucky Fried Chicken (KFC), Burger King, Subway, and Pizza Hut dominate the Malaysian fast-food market, according to Habib et al. (2011). These fast-food franchises have achieved great notoriety throughout the Malaysian Generation. In addition, according to the Malaysian Department of Statistics (2016), Generation Y students make up the greatest fraction of Malaysia's population of 12,67 million. Due to their lifestyle and eating habits, which impact their choices in the fast-food sector, Generation Y students are recognized as the most crucial market category. In addition, Generation Y eats out regularly and buys takeout from fast food restaurants; as a result, they

are always seeking production facilities that meet their needs. Generation Y students were selected as the acceptable target demographic for this inquiry.

## **Significance Of the Study**

### ***The fast-food consumption behaviour***

Food that is made rapidly and in a short period of time is commonly referred to as fast food. People enjoy fried and roasted foods, particularly adolescents. Multiple studies have demonstrated that people prefer fast food for a variety of reasons, including flavour, convenience, social contact, and enjoyment.

### ***Consumption of several dietary categories by adolescent in Malaysia***

Fast-food consumption is a negative eating habit since it increases the risk of diet-related chronic diseases. We were interested in the sociodemographic traits, body mass index (BMI) for age, eating behaviours when away from home, and consumption of the main food categories among Malaysian teens.

### ***Sociodemographic parameters***

Students in universities are among the populations most at risk for nutritional diseases due to their way of life and social environment. This study's objectives include measuring fast food consumption among college students and evaluating variables including socio demographic traits, BMI, and dietary habits that may have an impact.

### ***Increased Adolescent Obesity***

Due to the general hurried lifestyle, consuming fast food has become increasingly widespread today, where it has also become ingrained in metropolitan areas. According to Habib et al., 84 percent of university students in Malaysia eat fast food. Moore et al. (2009) found that individuals with the lowest levels of wealth and educational achievement were more likely to consume fast food than those with the greatest levels.

### ***Frequency of eating***

Three cognitive variables mindfulness disposition, self-efficacy, and nutrition knowledge were evaluated as independent variables, with frequency of dining out serving as the outcome variable. The relationship between cognitive characteristics and eating out frequently was evaluated using multinomial models.

## **LITERATURE REVIEW**

### **Personal Lifestyle**

Making healthy lifestyle choices is known as prudent regardless of age and because of that individuals of all ages sometimes have difficulty choosing the healthy option (Tasdemir et al., 2016). It is also pointed out that older people indicated greater intention particularly to make healthy choices in their current life rather than the younger generation did. Moreover, the individual's perspective on the future has shown to be a vital multidimensional construct affecting daily healthy lifestyle choices especially for teenagers and adults. Therefore, lifestyle modification involving physical activity, diet have been widely disseminated particularly for the treatment and prevention of disease (Deanna M. Minich, 2013).

### Price-Quality Inference

The price and quality of the product or service offered to customers will have a significant impact on the operations of a company. According to Goetsch and Davis (2014), quality encompasses every area of a business and is fundamentally a consumer's emotional experience. Consumers require a sense of satisfaction with their purchases, also known as the customer's perceived value, which is the emotion they should have had when they purchased an item at the best price. Therefore, consumers will take pride in their relationship with a company that has an excellent reputation. In addition, according to Oakland (2000), its use is far larger than assuring product or service quality, as it is a method of supervising corporate processes and ensuring complete consumer happiness at every level, both internally and externally.

### Promotions

The promotions mix (marketing and communications mix) is the exact combination of promotion tactics that the company employs to effectively communicate customer value and cultivate customer relationships. (Kotler et al. 2010). Promotion can be defined as the mode of communication often employed by a marketer in the marketplace. Additionally, promotion can be divided into four unique elements: advertising, public relations, word-of-mouth, and point of sale. Advertising encompasses all paid forms of communication, ranging from television advertisements, radio, and Internet pop-ups to newspapers and billboards. Moreover, public relations are a kind of communication that is not directly paid for, and this includes news releases, conferences, sponsorship, exhibition, events, and seminars. In addition, word-of-mouth is an ostensibly informal communication about a product by ordinary people, satisfied consumers, or those specifically engaged to develop word-of-mouth momentum.

### Research Framework

The Figure 1 below shows the research framework use for this study.

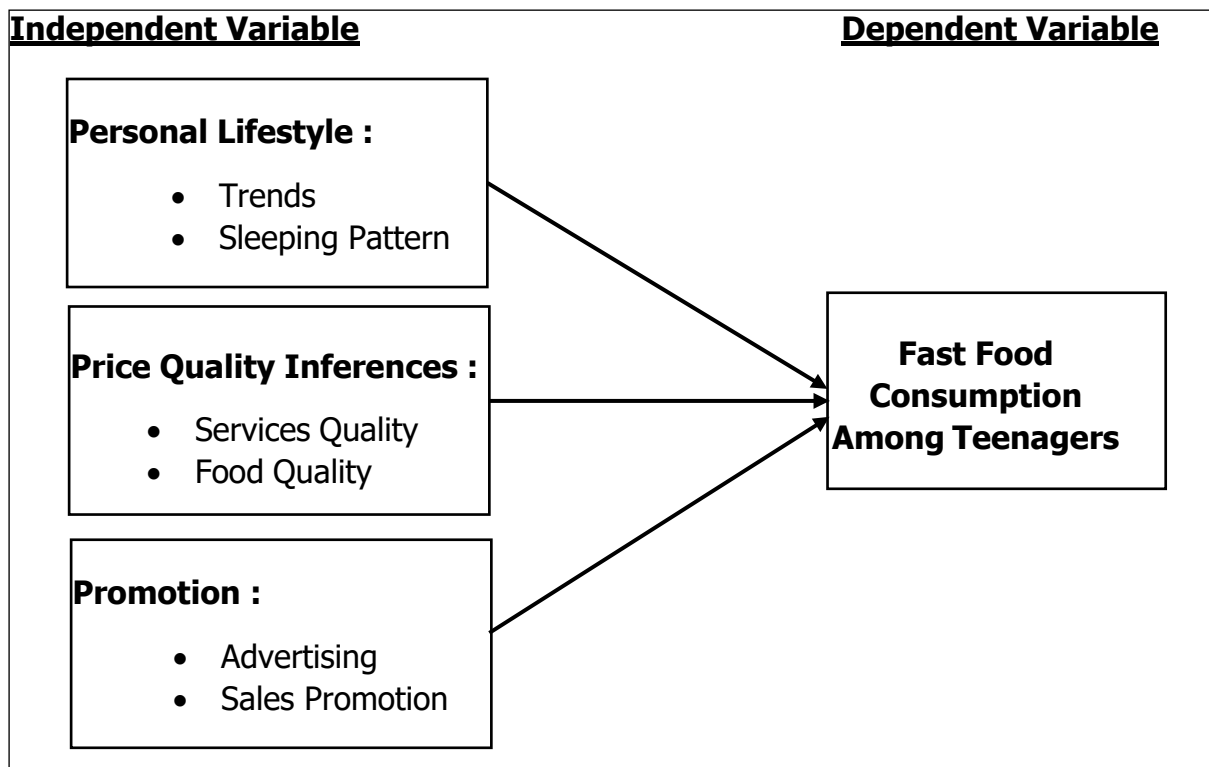

Figure 1: Research Framework

## **METHODOLOGY**

### **Research Design**

This research is using qualitative as a primary tool to collect respondents' data. The research focused on a qualitative analysis process that attempts to explain a social or human question from a range of perspectives.

### **Data Collection**

The interview is a strategy for methodically gathering data or observations. Fact gathering enables you to obtain first-hand knowledge and insights on a research issue whether you are working on a project for the corporate, government, or educational sectors. Although techniques and objectives may vary per industry, the overall approach to data collecting remains much the same (Bhandari, 2020). Interviews are a tried-and-true way of collecting qualitative data and have several benefits over other methods. Male or female voices might be used to conduct an interview. Body language may be seen during interviews, and either a guy or woman should use the proper approach (Rutakumwa et al., 2019).

### **Sampling**

The purposive sampling technique used to identify respondent with fast food consumption among teenagers. This sampling technique has used to achieve the aim objective for this research and to obtain data from the respondent. The teenagers of Pengkalan Chepa that was selected for this study, with 12 respondents.

### **Data Analysis**

Using Content Analysis to analyse the data. Content analysis is one of the most common qualitative research methodologies. The researcher must transcribe the interview and peruse the transcripts multiple times to gain an overview.

## **FINDINGS**

In this study, the researcher chooses purposive sampling which is the type of non – probability sampling technique. Purposive sampling is a means that the researcher used their own decisions about respondents to choose and picks those who best suit the purpose of the study and chooses (12) teenagers from Pengkalan Chepa.

### **Personal Lifestyle**

#### ***Trends***

Trends are something that develops over time. Today is recognized as the moment of a hectic life, and most people move quickly (Dragana M et al., 2020). Based on the interviews that were conducted. Most respondents responded that eating at fast food restaurants is not a trend. The following is a portion of the interview conversation.

“Eating at a fast-food restaurant is not hipster because people consume there.....”  
(Respondent 1)

“Fast food is typically regarded as mainstream and lacking in authenticity, whereas hipster culture tends to value unique, artisanal experiences. ...” (Respondent 2)

“Eating at a fast-food joint is not considered a hipster trend these days. In fact, fast food is a popular and widely accessible option for many people due to its affordability, convenience, and speed. ” (Respondent 3)

“Personally, I do not think eating fast food is a hipster these days. ” (Respondent 4)

“No, eating at a fast-food restaurant is not regarded as a "hipster" activity. Eating at a chain restaurant that sells mass-produced food may not be consistent with hipster culture's values of authenticity. ” (Respondent 7)

“I do think that eating at a fast-food joint is a hipster these days. Nowadays, eating at a fast-food joint is also a trend and today's generation loves to follow the trend. ...” (Respondent 8)

“Eating at a fast-food joint is not typically considered hipster. In fact, hipsters often seek out trendy, artisanal restaurants that offer unique and locally sourced menu options. ...” (Respondent 10)

“Eating at a fast-food joint is not considered hipster these days. In fact, many hipsters tend to avoid fast food chains and opt for more unique and artisanal food experience. ...” (Respondent 11)

Fast food consumption is not hipster or trendy, according to Eight (8) of the twelve (12) respondents. It is not hipster or trendy to dine at this fast-food restaurant. This is because when people arrive at the fast-food restaurant, they are hungry. Not for the fashionable or hipsters. So, this contradicts literature review.

### ***Sleeping pattern***

Another prevalence of fast-food consumption among teenagers is related to sleeping patterns. Sleeping patterns among teenagers have influenced them to increasingly consume fast-food. Hormones like a lack of leptin and an increase in ghrelin levels, which can cause an increase in appetite, may be one of the potential causes of sleep deprivation in combination with the consumption of higher energy meals (Gonnissen HK et al., 2013).

“There were times when I would order fast food from McDonald to eat because I was hungry late at night. ...” (Respondent 1)

“Sleep patterns can influence someone to come to a fast-food joint late at night. People who work night shifts or have other schedules that require them to be awake and active during the night may also be more likely to visit fast-food joints late at night as they may not have access to other food options during their work hours. ...” (Respondent 2)

“Sleep patterns can influence someone to come to a fast-food joint late at night. People who have irregular or disrupted sleep patterns may experience changes in their hunger and cravings, and they may feel hungry late at night when many other food options are not available. ...” (Respondent 3)

“I think it is true that sleep pattern related to someone coming to Fast-Food Joint late at night because someone who stays up may be hungry and they may choose the easiest way which is fast food. ...” (Respondent 4)

“There are still fast-food restaurants that operate more than 24 hours. No wonder if at 12pm there are still customers ordering food there. ...” (Respondent 6)

“Sleep habits can affect a person's decision to go to a fast-food restaurant after midnight. ...” (Respondent 7)

“I think sleep pattern does influence someone to come to fast food joint late at night. ...” (Respondent 8)

“Sleep patterns and fast-food consumption are interrelated. When we stay up late at night, food intake will increase. ...” (Respondent 9)

Nine (9) of the twelve (12) respondents agreed with the sleeping pattern. They feel that teenagers are now sleeping late at night and eating fast food at midnight. These are related to the previous research that teenagers were ordering their fast-food by food service app such as Food panda that known as popular food service application (Adam, 2021).

## **Price Quality Inference**

### ***Service Quality***

One of the prevalence of price – quality inference effects is shown by service quality. Most teenagers are satisfied with the service quality at fast-food joints. From the interviews conducted, most respondents stated that satisfaction with service quality. It is vital since a customer's cumulative experiences might result in either satisfaction or discontentment (K. Hussain, Jing, Junaid, Bukhari, & Shi, 2019) and in addition, previous research (Shurair & Pokharel, 2019) demonstrates that service providers must provide adequate seating and space for clients. Below is part of the conversation involved from interview.

“The service quality is, in my opinion, quite swift and great. I received polite treatment from the company's trained staff...” (Respondent 1)

“Based on my experience, all fast-food service quality at Pengkalan Chepa is good. The service provided is very good, satisfying and the service is fast...” (Respondent 2)

“Fast-food joints are known for providing quick, convenient, and affordable food options to their customers. They usually offer a limited menu of standardized items that can be prepared and served quickly, allowing customers to get in and out of the restaurant within a short period of time...” (Respondent 3)

“The services carried out in the Fast-Food Joint depend on the franchise, some of them are good but some are otherwise. So far, the services that I receive from the Mc Donald totally satisfy me because their staff is very easy to ask anything such as how to redeem the food in the Mc Donald's application...” (Respondent 4)

“Personally, I think they just make a good service just like MCD and KFC. This is because the service quality can vary at fast food joints depending on the specific location and management...” (Respondent 5)

“In my opinion, the quality of service at fast food is very good quality of service because their staff are agile in doing their work...” (Respondent 6)

“Fast food restaurants typically place a high priority on speed and convenience. For me, I would rather place their order while relaxing in their car, they frequently have a drive-through as well as indoor and outdoor seats...” (Respondent 7)

“About the services carried out in the fast-food joint, I could say that it is quite satisfying...” (Respondent 8)

“I think the services carried out in the fast-food joints have improved a lot. A good service will give a positive impression and excellent experience to the customers...” (Respondent 9)

“Fast-food joints offer quick and easy food services that cater to individuals who may not have the time or resources to prepare a meal themselves...” (Respondent 10)

“Generally, fast-food joints are known for providing quick and convenient services to customers. This is particularly appealing for people who are in a hurry and do not have much time to spare for a meal...” (Respondent 11)

“However, in general, it is important that the staff are courteous, efficient and provide quality customer service...” (Respondent 12)

All twelve (12) respondents agreed with the given query, which relates to the relationship between service quality and price quality inference. Many respondents agree that the service quality at Fast Food Joint is satisfactory and sanitary. This supports the literature review's conclusion about price quality, which is service quality.

### ***Food Quality***

Food quality demonstrates the prevalence of price-quality inference effects. Most teenagers are pleased with the food quality at quick food restaurants. The reason being the reasonable price. Most respondents who were interviewed expressed satisfaction with the service quality. According to Jun et al. (2017), customers desired nutritionally sufficient food. It is the responsibility of the service provider to utilize high-quality energy-supplying materials. The following is a transcript of a conversation from the interview.

“In my opinion “Excellent service, good menu, not too extensive. The food is excellent quality all around. They know how to make fries and their omelet sandwiches are the best...” Respondent 1)

“Based on my experience, the food is fast food, it is very satisfying. Besides, the quality of the food is great and worth it for me...” (Respondent 2)

“In general, fast-food franchises strive to maintain a consistent level of quality across all their locations, which is achieved through standardized food preparation methods, quality control measures, and regular training for employees...” (Respondent 3)



“The food at the franchise is nothing to complain about, as for my experiences the food that I ate at fast food restaurant are very good and I always repeat for it...” (Respondent 4)

“In my opinion, the food at the franchise was very good, especially “Nasi Lemak” MCD. Additionally, there are so many choices of food that I can choose there...” (Respondent 5)

“Personally, I think franchise food has a variety that is different from other types of food. I admit franchise food is much tastier than other food...” (Respondent 6)

“Fast food chains are renowned for providing a small selection of options that are quick...” (Respondent 7)

“Honestly, I enjoy the food at the fast-food joint and the food at the franchise is good and variety...” (Respondent 8)

“I think the food at the franchise provides a variety of choices. Different types of menus and first-class services are my top priorities...” (Respondent 9)

“The food quality at a franchise can vary based on the individual location, the menu options, and the preferences of the customers...” (Respondent 10)

“Some customers find the food to be delicious, with generous servings and good value for the price. Others may find the food to be average or below average in terms of quality or taste...” (Respondent 11)

“The quality of the food at Fast-Food Joint can also vary depending on the location and the specific items being ordered...” (Respondents 12)

All twelve (12) respondents agreed with the given query, which relates to the relationship between food quality. Many respondents agree that the food quality at Fast Food Joint is satisfactory and sanitary. This is because the quality of the food provided is satisfactory, the price is low, and it is delicious. This supports the literature review's conclusion about price quality, which is food quality.

## **Promotion**

### ***Advertising***

Each quick food restaurant engages in advertising. With this advertising, they hope to attract consumers to their fast-food restaurants. This interview was conducted by us, and the response to advertising is provided below.

“Because I frequently consume fast food, my peers occasionally invite me to eat nearby. My sister once took me to a McDonald's nearby to sample the new. ” (Respondent 1)

“Fast food joints use various advertising tactics to promote their products and services to potential customers, such as television commercials, online ads, billboards, social media promotions, and more. These advertisements are designed to create brand awareness. ” (Respondent 2)

“In my opinion, advertising can make people come to fast-food joints. Advertising is a powerful tool that can help fast-food joints create brand awareness. ” (Respondent 3)

“The reason why I came to Fast-Food Joint is because of viral. It attracts me to try the new food or new menu that viral on the internet. ” (Respondent 4)

“The reason why I came to Fast-Food Joint is because when I scroll on my social media, it always appears an advertisement such as a new menu ” (Respondent 5)

“I go to fast food because the advertisement or marketing made it look appetizing and fast food is also on my visit ” (Respondent 6)

“It is possible that we came to the fast-food joint for a quick and convenient meal. Fast-food restaurants are known for their speed and accessibility ” (Respondent 10)

“It is possible that they came to Fast-Food Joint because it was nearby and convenient for them. It is also possible that they came for the specific food items offered by Fast-Food Joint that they enjoy. ” (Respondent 11)

“The reasons why someone chooses to visit Fast-Food Joint can be multifaceted. Some people may choose to visit for convenience, particularly if they are short of time and need a quick meal. ” (Respondent 12)

Nine (9) of twelve (12) respondents stated that they visited this quick food restaurant due to the advertisement. People visit quick food restaurants due to advertisements on television and on social media. However, three (3) respondents disagreed; they did not visit the quick food restaurant because of the advertisement. Consequently, most respondents support advertising. This proves that the Literature review is supported by evidence.

### ***Sales Promotion***

Sales promotion is a promotion run by fast food to attract customers. According to Cannon, et al. (2009), sales promotion is defined as promotional efforts that spur curiosity, experimentation, or purchases from end users or other channel participants in addition to advertising, publicity, and personal sales.

“That's correct, I also visited McDonald's because of a promotion. Because I have the McDonald's app installed, I occasionally receive discounts. ” (Respondent 1)

“Yes, sales promotions can inspire individuals to patronize fast-food restaurants. Sales promotions can also be effective in attracting new customers, ” (Respondent 2)

“Yes, sales promotions can make people come to fast-food joints. Sales promotions, such as discounts, coupons, or special deals, can be very effective in attracting..... ” (Respondent 3)

“The sales promotion makes anyone come to the Fast-Food Joint because people can get affordable prices especially for the food they like. .... ” (Respondent 4)

“Sales promotions can be effective in drawing in customers, as they offer discounts or deals that incentivize people to visit..... ” (Respondent 5)

“In my opinion, the sales promotion that is done is also one of the reasons why fast-food restaurants get quite good visitors today. .... ” (Respondent 6)

“Yes, using promotional offers draws people to fast food restaurants. Sales promotions, such as reduced rates, time-limited deals can generate excitement for me. ” (Respondent 7)

“The sales promotion makes people come to the fast-food joint. I think it is because whenever this franchise has a promotion, people are always exposed to it. Nowadays, people always have their phone in their hands. ” (Respondent 8)

“Sale promotion is an excellent marketing strategy to attract customers. For example, a special price on certain meals invites the customers to purchase the products or services. ...” (Respondent 9)

“It is possible that the sales promotion may entice some customers to come to the Fast-Food Joint. This is because customers are often attracted to special offers and discounts, which can make the Fast-Food Joint more appealing than its competitors. ” (Respondent 10)

“It depends on the effectiveness of the sales promotion. If the promotion is appealing enough to the target audience, it has the potential to attract customers to the Fast-Food Joint. However, if the promotion is unclear, uninteresting, or poorly executed, it may not have a significant impact on the number of customers visiting. ” (Respondent 11)

“Sales promotions can be a significant factor in driving customers to Fast-Food Joint. Promotions and discounts may offer a more significant incentive for customers who are price-conscious and may encourage them to visit more frequently. ” (Respondent 12)

All twelve (12) respondents visit fast food restaurants because of the sale. All respondents concurred that this sale promotion drove them to quick food restaurants. Therefore, this sales promotion supports the Literature review, as the interview we conducted prior to conducting the Literature review concurred with the Literature review.

## **DISCUSSION**

There are various thoughts and views that have been collected during the interview of 8 Community in Pengkalan Chepa which specifically teenagers toward fast food consumption among teenagers in Pengkalan Chepa, Kelantan.

### **Trends**

Based on this research, throughout the in-depth interview with the eight respondents, three main objectives have been addressed. The first objective is to explore the fast-food consumption among teenagers in Pengkalan Chepa, Kota Bharu. Based on the findings, it shows many contradictory trends. Most of them contradictory trends. For example, which was quoted by respondents 2.” Fast food is typically regarded as mainstream and lacking in authenticity, whereas hipster culture tends to value unique, artisanal experiences.” This is not supported by the statement fast food consumption among teenagers. Most respondents do not frequent fast food restaurants for the latest trends. They visit the quick food restaurant due to their hunger.

### **Sleeping Pattern**

When the respondent was asked about sleeping pattern, similar answers were given by the respondent. The finding showed that of twelve (12) respondents only (11) respondents have

sleeping patterns of fast-food consumption among teenagers. People with disrupted or irregular sleeping patterns, such as those who stay up late or work night shifts, may experience late-night cravings for food. Fast food joints often remain open late or even 24 hours, making them convenient options for satisfying those cravings. This is supporting literature review because most respondents agreed with sleeping patterns.

### **Service Quality**

The second objective that has been addressed is explore the price quality inference of fast-food consumption among teenagers. The respondent was asked about the service quality that can trigger fast food consumption. This study covered all respondents. All the respondents said the service quality is good and fast. For example, quote from respondents 3. "Fast-food joints are known for providing quick, convenient, and affordable food options to their customers. They usually offer a limited menu of standardized items that can be prepared and served quickly, allowing customers to get in and out of the restaurant within a short period of time..." All respondents supported service quality run by a fast-food joint. This is very important to discuss the service quality carried out by each fast-food joint.

### **Food Quality**

The respondents were asked about the food quality that can be a predictor of fast-food consumption. This study discovered twelve (12) respondents were satisfied with the food quality provided by the fast-food joints. The cuisine at the fast-food restaurant is inexpensive, tasty, and varied. There are fast food restaurants on every continent, making quick food readily available. Quality ingredients, it was evident that this fast-food joint prioritizes the use of quality ingredients. The meats were of a noticeably higher standard compared to what one might expect from fast food. The chicken was tender and juicy, while the beef had a rich and robust flavor. Additionally, the cheese, sauces, and condiments complemented the overall taste profile, providing a satisfying and enjoyable dining experience. For example, quote from respondents 6. "Personally, I think franchise food has a variety that is different from other types of food." Therefore, this has demonstrated support for literature review.

### **Advertising**

The last objective that has been addressed is to explore the promotion of fast-food consumption among teenagers in Pengkalan Chepa, Kota Bharu. This study discovered that of 12 respondents, 3 respondents did not agree with advertising for fast food. Meanwhile 9 respondents agree with going to fast food joints causes advertising. Advertising can be a significant factor in influencing consumer behavior and driving people to visit fast-food joints. Effective advertising campaigns can create awareness, generate interest, and entice individuals to try a particular fast-food restaurant. Advertising can showcase the menu items, highlight promotions or deals, and create a desire for the food being advertised. Aside from that, nine (9) respondents concurred with advertising; therefore, this advertising supports the literature review.

### **Sales Promotion**

Respondents were asked about the sales promotion of Fast food is an important part of my thesis. This study discovered all respondents (12). All respondents understood the sales promotion conducted by the fast-food restaurant. Sales promotions, such as discounts, coupons, limited time offers, or combo deals, are designed to create a sense of urgency and incentivize customers to make a purchase. When a fast-food joint offers an appealing sales promotion, it can capture the attention of potential customers who may be enticed by the perceived value or cost savings. Sales promotions can be effective in attracting both new customers and

encouraging repeat visits from existing customers. The allure of a special deal or discount can motivate individuals to choose a particular fast-food joint over others, especially when they feel they are getting a good deal or saving money. This makes teenagers more interested because it saves them money. Therefore, this Literature review is supported because all respondents agree with the sale promotion.

### **RECOMMENDATION**

Based on the research, most of the respondents disagree and are aware that prevalence of fast-food joints is not a trend. Other than that, there were a few respondents who agree that fast-food joints are a trend. Based on this research, most of the respondents support sleeping patterns because as teenagers they frequently stay up at night and easily feel hungry when studying. Those who feel hungry will order fast food because at late night most restaurants have been closed. It is recommended for teenagers to order fast food at night to help relieve stress while doing homework and studying. It also helps them to keep focused on doing their business.

Besides, based on the interview among all the respondents, the majority states that service quality can be defined as meeting or exceeding customers' expectations regarding delivery of service. They believed it is the major factors that involved service quality which is speed of service, cleanliness, staff friendliness, and overall customer experience

### **CONCLUSION**

This study explored the fast-food consumption among teenagers in Pengkalan Chepa, Kota Bharu, Kelantan. The information on the respondents had gathered through 12 interviews via purposive sampling. The study indicated that personal lifestyle including trend, sleep pattern; price quality inference which is service quality and food quality, as well as promotion like advertising and sales promotion leads to fast-food consumption among teenagers in Pengkalan Chepa, Kota Bharu, Kelantan.

## REFERENCE

- Abraham, S., Martinez, M., Salas, G., & Smith, J. (2018). College student's perception of risk factors related to fast food consumption and their eating habits. *Journal of Nutrition and Human Health*, 02(01).
- Abdullah, N. N., Mohamad Mokhtar, M., Abu Bakar, M. H., & Al-Kubaisy, W. (2017). Fast Food Consumption and Obesity. *Asian Journal of Quality of Life*, 2(6), 11.
- Akter, M., Sadekin, M. N., & Patwary, A. K. (2020). An Empirical Study on Students' Satisfaction from Mawlana Bhashani Science & Technology University, Bangladesh. *Review of Economics and Development Studies*, 6(2), 363-379.
- AlFaris, N., Al-Tamimi, J. Z., Al-Jobair, M. O., & Al-Shwaiyat, N. M. (2015). Trends of fast-food consumption among adolescent and young adult Saudi girls living in Riyadh. *Food & Nutrition Research*.
- Alom, S., Patwary, A. K., & Khan, M. M. H. (2019). Factors affecting the turnover intention of Bangladeshi migrants in the United Arab Emirates: An empirical study on the hotel industry. *International Journal of Innovation, Creativity and Change*, 8(3), 344-360.
- Amir, M. (2021, September 6). *Fast Food Statistics in Malaysia (Pre-Pandemic and Current Times) [2021 ]*. Trusted Malaysia.
- Anitharaj, M. S. (2018). A study on Behaviour of Youngsters towards Fast Food Restaurants, *International Journal of Emerging Research in Management and Technology* Vol. 7, Issue 1, pp1-7.
- Benajiba, N. (2016). Fast food intake among Saudi population: Alarming fact. *American Journal of Food and Nutrition*, 6 (2), 44-48.
- Binkey, S. (2019). Fast-food marketing and children's fast-food consumption: a trigger to children obesity. *Indian Journal of Public Health Research & Development*, 10(7), 173-177.
- Cheong, K. C. Ling, C. Y., Hock, L. K., Ghazali, S. M., Huey, T. C., Ibrahim, M. K. C., ... Yusoff, A. F. (2019). Association between availability of neighborhood fast food outlets and overweight among 5–18-year-old children in peninsular Malaysia: A cross-sectional study. *International Journal of Environmental Research and Public Health*, 16(4), 593.
- Daradkeh, G., Al Muhannadi, A., & Al Hajr, M. (2018). Fast Food vs Healthy Food Intake and Overweight/Obesity Prevalence among Adolescents in the State of Qatar. *Journal of Obesity Treatment and Weight Management*, 1 (1), 2
- Deanna M. Minich, J. S. (2013). "Personalized Lifestyle Medicine: Relevance for Nutrition and Lifestyle Recommendations", *the Scientific World Journal*, vol. 2013, Article ID 129841, 14 pages, 2013.
- Department of Statistics Malaysia. (2019). *Services Producer Price Index Second Quarter of 2019.D.o.S.Malaysia*.
- Dornelles, A. (2019). Impact of multiple food environments on body mass index. *PLOS ONE*, 14 (8), e0219365.
- Economics & Business Solutions Journal Volume 2, Number 2, 2018, 2580-8079 1 STRATEGIC ROLE OF SALES PROMOTION IN INCREASING THE NUMBER OF VERMOX DRUG SALES
- El-Gilany, A. H.-H. (2016). Mısır Mansoura üniversitesi'nde tıp öğrencileri arasında çabuk yemek (Fast food) tüketim ve bilgisi. *TAF Preventive Medicine Bulletin*, 15 (5), 440–445.

- Fengmin, Z., Baijun, W., Jiangtao, B., Li, L., & Patwary, A. K. (2022). Investigating revisit intention of medical tourists in China through nutritional knowledge, perceived medical quality, and trust in the physiologist: A recommendation on health tourism policy measures. *Frontiers in Public Health*, 10, 893497.
- Garza, K. B., Ding, M., Owensby, J. K., & Zizza, C. A. (2016). Impulsivity and fast-food consumption: *a cross-sectional study among working adults*. *Journal of the Academy of the Nutrition and Dietetics*, 116(1), 61-68
- Gonnissen, H. K., Adam, T. C., Hursel, R., Rutters, F., Verhoef, S. P., & Westerterp-Plantenga, M. S. (2013). Sleep duration, sleep quality and body weight: parallel developments. *Physiology & Behavior*, 121, 112-116..
- Hazbar, A. M. H., Alem Mohammed, A., & Karim, A. K. A. (2019). An Empirical Study of Factors Influencing hotel customers' online booking Intention. *مجلة العلوم التربوية و الدراسات الإنسانية*, (5), 1-17.
- Li, L., Ragavan, N. A., Patwary, A. K., & Baijun, W. (2022). Measuring patients' satisfaction toward health tourism in Malaysia through hospital environment, nutritional advice, and perceived value: A study on Chinese exchange students. *Frontiers in public health*, 10, 893439.
- Li, L., Wu, B., & Patwary, A. K. (2022). How marine tourism promote financial development in sustainable economy: new evidences from South Asia and implications to future tourism students. *Environmental Science and Pollution Research*, 29, 1155-1172.
- Li, L., Wu, B., & Patwary, A. K. (2022). The psychosocial factors affecting chinese Outbound Exchange and mobility students' academic performance during COVID-19. *Frontiers in psychology*, 13, 872516.
- Patwary, A. K., Roy, B., Hoque, R., & Khandakar, M. S. A. (2019). Process of developing a community based tourism and identifying its economic and social impacts: An Empirical study on Cox's Bazar, Bangladesh. *Pakistan Journal of Humanities and Social Sciences*, 7(1), 1-13.
- Sumethokula, P., Patwary, A. K., Srinuanpanc, B., Srinuanpand, C., Suwandee, P., Thammathikul, A., & Phanong, W. (2020). The potential of new tour repackaging for creative tourism among entrepreneurs in Nakhon Si Thammarat. *International Journal of Innovation, Creativity and Change*, 13(10), 1752-1771.
- Wu, B., Liu, S., Wang, J., Tahir, S., & Patwary, A. K. (2021). Assessing the mechanism of energy efficiency and energy poverty alleviation based on environmental regulation policy measures. *Environmental Science and Pollution Research*, 28, 40858-40870.
- Wu, B., Zhai, B., Mu, H., Peng, X., Wang, C., & Patwary, A. K. (2021). Evaluating an economic application of renewable generated hydrogen: A way forward for green economic performance and policy measures. *Environmental Science and Pollution Research*, 1-15.

# **CUSTOMER SATISFACTION WITH TRADITIONAL & COMPLEMENTARY MEDICINE AMONG COMMUNITY IN PENGKALAN CHEPA, KELANTAN**

*NOR SYAFIQAH BINTI ROSLAN, NUR EZATUL IRANIE BINTI SHUIB, NUR FAKHIRA IZZATI BINTI FAISAL, NURUL NAJIHAH BINTI MOHD ZAMBRI & PROF. MADYA DR. HASIF RAFIDEE BIN HASBOLLAH*

*Faculty of Hospitality, Tourism and Wellness, Universiti Malaysia Kelantan  
Corresponding email: rafidee@umk.edu.my*

---

## **ABSTRACT**

Society's culture and belief system play an important role in the perception of health, behavior and individual response to illness and treatment methods. Almost all societies in the world combine several methods in the treatment of a disease, especially the use of traditional and alternative treatment methods, as well as modern medicine. The issue of customer satisfaction with Traditional and Complementary Medicine is the most important obstacle to any medicine. A qualitative study was conducted to identify the factors that influence customers toward Traditional and Complementary Medicine in the community of Pengkalan Chepa, Kelantan. In-depth interviews were conducted with 8 respondents. The data obtained were analyzed using the content analysis method. The findings of the study show that the community in Pengkalan Chepa, Kelantan has a problem of satisfaction with this Traditional and Complementary Medicine. The findings of this study also show that the community of Pengkalan Chepa, Kelantan is aware of the importance of traditional and complementary medicine.

**Keywords:** *Traditional and Complementary treatment method, Factors that influence customers towards Traditional and Complementary Medicine Society in Pengkalan Chepa, Kelantan.*

---



## **INTRODUCTION**

Traditional and Complementary Medicine Act 2016 (Act 775) defines traditional and complementary medicine practices as a form of practice related to health aimed at preventing, treating, or managing illness or disease or preserving the physical and mental well-being of individuals. Traditional medicines can be the "mainstay" of healthcare delivery in the "developing" world, particularly in remote or rural areas (WHO 2017). The use of complementary medicine (CM), defined as products and practices outside of the dominant medical paradigm, is popular in many parts of the world and is recognized as a significant public health issue by the World Health Organization. CM is broadly classified into one of two categories, mind-body practices (i.e. yoga, meditation) and natural products (i.e. vitamins, and herbal medicines) (Amie Steel et al., 2018). Traditional, complementary, and alternative medicine practices emphasize the holistic approach and include medicinal plants. Herbal medicines, as well as complementary and alternative medicine, are becoming more popular in industrialized countries for disease prevention and health maintenance (Bodeker et al., 2005).

### **SIGNIFICANCE OF THE STUDY**

#### **Industry**

The importance of this study aims to explain the acceptance of Traditional and Complementary Medicine in the industry. Traditional medicine in Malaysia is unique because it has own history based on the diversity of heritage, culture, language, and race. The traditional and complementary medicine industry will be professionalized with the medical services being ensured to be safe, quality, and accessible to all. Committed to developing the field of traditional and complementary medicine, along with integrating it with the field of modern medicine.

#### **Community**

This research may aid in the delivery of healthcare to people. The use of Traditional and Complementary Medicine (TCM) in the community for illness prevention and treatment has grown in popularity. Along with modern medicine, traditional and complementary medicine may play a significant role in improving the health and quality of life of Malaysians in this nation's healthcare system.

## **Operator Traditional and Complementary Medicine**

Besides that, in this study, Traditional and Complementary Medicine practitioners can also be improved in terms of service quality. This can be seen when every practitioner must be registered, recognized, and controlled to ensure that the services provided are safe. Therefore, the strategy that needs to be carried out to achieve objectives such as promoting traditional medicine training programs and complementing each other between domestic and foreign institutions.

## **LITERATURE REVIEW**

### **Treatment Effects**

Previous studies have shown that there are positive results obtained from traditional and complementary medicine such as acupuncture. The review included thirty studies, 93% of which demonstrated positive treatment effects of acupuncture in improving various aspects of sleep.(Daniel et al., 2017). Traditional Indian Medicine, or Ayurveda, has also contributed to the growing list of valuable compounds. Ancient remedies for nervous system disorders, including memory-related conditions like dementia, have been validated by the findings. Attempts have been made to conduct experimental studies on Ayurvedic medicine in order to better understand its effects on geriatric diseases such as Alzheimer's (M. Tateno et al., 2008). A study shows that the direct effect of cupping suction on the area increases local blood and lymph flow (David et al., 2002). Local increases in blood and lymph flow will help with local myofascial pain (Jafri MS., 2014).

### **Service Quality**

In Malaysia, a national survey revealed that 21.5% of people had used T&CM services in the previous 12 months, and 29.3% had used T&CM services in some capacity over the course of their lifetime. Males in Malaysia reported using T&CM services 19.3% more often than females (23.9%), and the urban population used T&CM services at a higher rate (22.6%) than the rural population (18.2%). Currently, the private sector (primarily sole proprietors) dominates the provision of T&CM services in Malaysia, with the public sector playing a relatively small role. Malaysia reported that in 2014, T&CM services accounted for Ringgit Malaysia (RM) 2084 million in total out-of-pocket health spending (OOP), or 11.0% of all OOP spending at private health facilities. For the majority of T&CM services, the median OOP expenditure per person was less than RM 60.70 (Complementary Therapies in Medicine, 2019).

## Knowledge of Treatment

The term "TCM products" refers to complementary and alternative medicine products, dietary supplements, herbal medicine, health supplement, vitamins, minerals, and natural products. TCM products have grown in popularity across the globe. TCM is thought to be used by hundreds of millions of people in the European Union (EU), with estimates ranging as high as 90% of the population in some countries (E. Ben-Arye et al., 2012).

Some oncology patients, as well as renal and liver transplant recipients, may use TM/CM products to improve the efficacy and side effects of conventional medications or to help improve their overall well-being (Foronczewicz et al., 2011).

## Research Framework

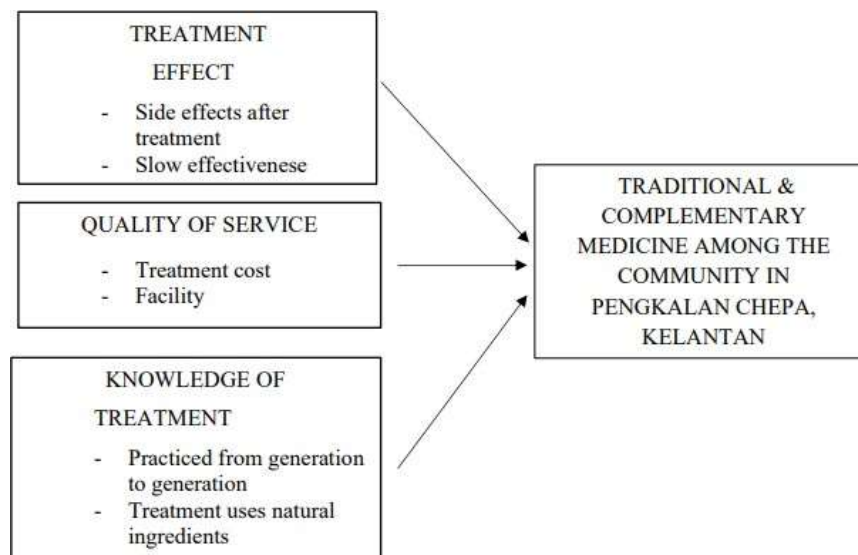

Figure 1 below shows the research framework used for this study.

It is discussed the factors that affect customer satisfaction with Traditional & Complementary Medicine in the community of Kelantan. The impact is due to treatment effects, quality of service, and knowledge of treatment.

## **METHODOLOGY**

### **Research Design**

This study employs qualitative data collection as a primary strategy for collecting respondent data, including the use of multiple data sources such as interviews and observations. The contents or formats of a research proposal vary depending on the needs of the assessment committee and are typically provided by the committee or the university (Devika et al., 2016). It was gathering qualitative data through methods such as interviews and observations, as well as guiding questions that could reveal the quality of a product. The interview questions will be open-ended to allow participants to fully express themselves (Gaudet & Robert, 2018).

The research is critical for linking data collection, analysis, and acquiring results and conclusions to determine the research's main objectives (Riley et al., 2015).

### **Data Collection**

The interview is a method of collecting observations or measurements in a methodical manner. Interviews are a tried-and-true method of gathering qualitative data, with many advantages over other types of data collecting.

An interview can be conducted in either male or female voices, via a smartphone with a dependable cloud or hosted PBX system, or via video call. Because the interviewer can see body language, in man or woman method is appropriate.

In this study, the interview method was used for this research by obtaining respondents. We conducted face-to-face interviews to obtain information on customer satisfaction with Traditional & Complimentary Medicine in the community of Pengkalan Chepa, Kelantan.

### **Sampling**

The researcher wants to identify customer satisfaction about Traditional & Complementary Medicine among the community at Pengkalan Chepa, Kelantan and only the study subjects who have used traditional & complementary medical services are selected as respondents.

Objective techniques are used to identify people who are dissatisfied with Traditional and Complementary Medicine.

Multiple embedded are used to determine customer satisfaction using TCM services among residents of Pengkalan Chepa. All respondents consist of 6-12 respondents from Pengkalan Chepa who have received TCM treatment.

## **Data Analysis**

The data analysis process is the manner of gathering, analyzing, manipulating, and modeling facts to extract usable information, draw conclusions, and useful resource decision-making. All the interview transcripts from the respondents will appropriately be analyzed to seize the experience of the complete data.

In addition, the data analysis process included thematic analysis. Thematic analysis refers to analysis that usually involves qualitative analysis methods that include reading through data sets (such as transcripts from interviews) and identifying patterns of meaning across the data, especially to obtain themes. The thematic analysis began by searching for data coding based on the objective of the study explores the treatment effects, quality of the service and the knowledge of treatments among the community in Pengkalan Chepa, Kelantan.

## **FINDINGS**

In this study, the researcher chooses purposive sampling which is a type of non – probability sampling technique. Purposive sampling is a means that the researcher used their own decisions about respondents to choose and picks those who best suit the purpose of the study and chooses 8 teenagers from Pengkalan Chepa.

### **Treatments Effect**

#### ***i. Side Effects After Treatments***

One of the prevalences of TCM treatment effects is shown by side effects after treatment. Most spa clients have no side effects while some spa clients have side effects. From the interviews conducted, most respondents stated that they did not have such severe side effects. Below are part of the conversation involved from the interview.

“After receiving this treatment, I did not experience any harmful side effects and my body felt lighter ..” (Respondent 1)

“I have had no side effects after receiving this treatment.” (Respondent 2)

“After doing this chiropractic treatment, I feel relieved and not tired anymore. I have not experienced any side effects.” (Respondent 3)

“I did not experience harmful side effects after doing this cupping treatment ..” (Respondent 4)

“After receiving this cupping treatment, I did not experience any harmful side effects ..” (Respondent 7)

Five (5) out of eight (8) respondents mentioned that they have no side effect after treatments towards Traditional & Complimentary Medicine (TCM). Generally, traditional and complementary medicine appears as a safe treatment and doesn't have a side effect. Most people feel relaxed and release their tension after treatment. However, some people shouldn't have the treatments of traditional and complementary medicine such as digestive issues.

### *ii. Slow Effectiveness*

Another prevalence of Traditional & Complimentary Medicine (TCM) is related to slow effectiveness. The effectiveness of TCM may depend on several factors, including the type and severity of the condition being treated, the individual's overall health, and the specific TCM treatments being used (Lipton et al., 2017). Below are part of the conversation involved in the interview.

“After receiving this treatment, my body is less painful and no longer has inflammation. Its effectiveness takes a relatively short time to heal.” (Respondent 2)

“My body feels better than before the treatment. Shoulders and neck feel comfortable and no longer tense. The whole body feels lighter and more comfortable ..” (Respondent 3)

“After this treatment, my body feels lighter and more energetic.” (Respondent 4)

“I have done this treatment more than three times. This is because it makes my body feel lighter and more comfortable ..” (Respondent 5)

“For me, this treatment is effective for my body because after doing this treatment, my body feels lighter and fitter..” (Respondent 6)

“After doing this treatment, my body feels relieved and lighter. It has a positive effect on my body.” (Respondent 7)

“After performing this treatment, my body feels effectiveness relieved and comfortable. The moaning I experienced is gone..” (Respondent 8)

Seven (7) out of eight (8) respondents mentioned that Traditional & Complimentary Medicine (TCM) have effectiveness on their body. Traditional and Complementary Medicine (TCM) treatments often involve the use of natural remedies and therapies to help the body heal itself. While TCM treatments can be effective for many people, they may not work as quickly as conventional Western medicine.

## **Service Quality**

### ***i. Treatment Cost***

The cost of Traditional and Complementary Medicine (TCM) treatment can vary widely depending on the type of treatment, the practitioner, and the location. There are many respondents who agree that the cost of the treatment provided at the spa is very worthwhile and the price is reasonable. Below are part of the conversation involved from the interview.

“ The service here is very worth the price offered .. ” (Respondent 1)

“ For me, the service provided is worth the price offered. I am very satisfied with the service and hospitality provided ..” (Respondent 2)

“The price offered is reasonable with the service provided. I have had treatment here twice ..” (Respondent 3)

“ For me the price offered is reasonable. It's not expensive and it's standard for me ..” (Respondent 4)

“ I am satisfied with the cupping treatment here because it is effective for my body. ” (Respondent 5)

“ The price offered is also quite cheap and reasonable ..” (Respondent 6)

“The price of this treatment for me is reasonable with the service provided .. ” (Respondent 7)

“ The price of body massage treatment here is reasonable. It is not expensive for me .. ” (Respondent 8)

All eight (8) respondents agreed with the given question which are treatment cost of the TCM is affordable. In general, TCM treatments tend to be cheaper than conventional Western medical treatments, although this may not always be the case.

## *ii. Facility*

One of the customer satisfaction towards Traditional & Complimentary Medicine (TCM) is shown by the facility provided by the Spa. A spa should be in a good location, comfortable and at the same time not cause any damage or danger to health or be close to a place of worship. Below are part of the conversation involved from the interview.

“The equipment provided is very sufficient with good treatment for me and my baby.” (Respondent 1)

“The equipment provided in this spa is quite good. The rooms and massage beds provided are very comfortable ..” (Respondent 2)

“The rooms provided are also comfortable. The treatment equipment is also complete and safe to use ...” (Respondent 3)

“The equipment provided is also complete and the treatment place is also comfortable and clean.” (Respondent 4)

“The tools used are also safe and clean. The rooms and beds provided are also very comfortable and the environment is clean and tidy.” (Respondent 5)

“The treatment rooms and beds provided are also comfortable and clean.” (Respondent 6)

“Equipment for treatment is well prepared. The treatment room and bed are comfortable.” (Respondent 7)

“The treatment room and beds provided are also comfortable. The room is not very spacious but it is quite comfortable ..” (Respondent 8)

All of the eight (8) respondents are very satisfied with all the facilities provided by the spa. The Spa area must also have sufficient lighting to carry out a service and have an adequate ventilation system for the comfort of customers who come to get services.



## **Knowledge of treatment**

### ***i. Practiced from generation to generation***

Practiced from generation to generation is one of the big predictors of Traditional & Complimentary Medicine (TCM). Traditional and Complementary Medicine (TCM) encompasses a range of healing practices that have been passed down from generation to generation in many cultures around the world. Below are part of the conversation involved from the interview.

“I found out about the services here through my sister who used to get treatment here..”

(Respondent 1)

“I found out about the treatment and services here through my son. My daughter used to get treatment here ..” (Respondent 3)

“I found out about the treatment and services here through my son. My daughter used to get treatment here. My daughter has a painful and crooked spine ..” (Respondent 4)

“I found out about the cupping treatment here through my neighbor..”

(Respondent 7)

Four (4) out of eight (8) respondents still practice this TCM from generation to generation. Traditional & Complimentary Medicine is a type of medicine or treatment inherited from our ancestors and inherited from one generation to another. This TCM is specific to the Malays and is more typical based on certain areas. It also different from the medicine practiced today because this type of medicine was used at the time specifically with the purpose of health care and suitable for a certain community.

### ***ii. Treatment uses natural ingredients***

The treatment uses natural ingredients that have also been identified on Traditional & Complimentary Medicine. One of the key principles of Traditional and Complementary Medicine (TCM) is the use of natural ingredients to promote healing and balance in the body. Below are part of the conversation involved in the interview.

“The spa uses completely natural ingredients in its treatments such as herbal oils for massage. This spa also uses their own products which are traditional herbs for various internal problems produced 100% from organic herbs ..” (Respondent 1)

“This spa makes full use of natural ingredients in this treatment by using herbal oils”  
(Respondent 2)

“This spa also uses completely natural ingredients in the treatment by using herbal oils produced from trees.” (Respondent 3)

“In this treatment, the spa not only uses cupping tools, it also uses organic ingredients such as olive oil.” (Respondent 4)

“In addition to using cupping tools, this treatment also uses an organic material which is the original *but-but* oil (HPA Oil).” (Respondent 5)

“In this treatment, the spa uses only herbal oils for massage. No other drugs and no needles or other tools. It's just a sequence.” (Respondent 6)

“This cupping treatment uses cupping tools such as knives, needles, cups and several other tools. This treatment also uses organic ingredients such as olive oil.”  
(Respondent 7)

“For the massage performed by this spa, only traditional massages and herbal oils and the spa's own products are used. The ingredients used for massage oil are only natural ingredients..” (Respondent 8)

All of eight (8) respondents said that the treatment used natural ingredients. Many TCM treatments utilize herbs, plants, and other natural substances to create remedies and therapies that are believed to have medicinal properties. Some common natural ingredients used in TCM treatments include herbal remedies, cupping, massage therapy and acupuncture.

## **DISCUSSION**

There are various thoughts and views that have been collected during the interview of 8 Community in Pengkalan Chepa which specifically teenagers toward fast food consumption among teenagers in Pengkalan Chepa, Kelantan.

### **Side Effects After Treatments**

Based on this research, throughout the in-depth interview with eight respondents, three main objectives have been addressed. The first objective is the effect of the treatment. Based on the findings, it shows the side effects after treatment in most respondents. Most of them have no side effects after treatment. For example, which was quoted by respondent 1, "After receiving this treatment, I did not experience any harmful side effects and my body felt lighter and I was able to exercise a lot after the massage." This is supported by the statement Traditional & Complementary Medicine appears as a safe treatment and doesn't have side effects. Most people feel relaxed and release their tension after treatment. (Tabish, S. A. (2008).

### **Effectiveness**

When the respondents were asked about the effectiveness, similar answers were given by the respondents. The finding showed that of eight (8) participants have effective treatment of TCM. Traditional & Complementary Medicine (TCM) treatments often involve the use of natural remedies and therapies to help the body heal itself. While TCM treatments can be effective for many people, they may not work as quickly as conventional Western medicine. The effectiveness of TCM may depend on several factors, including the type and severity of the condition being treated, the individual's overall health, and the specific TCM treatments being used. Some TCM treatments, such as acupuncture or massage therapy, may provide immediate relief for certain symptoms, while others, such as herbal remedies, may take longer to take effect. It's important to note that TCM treatments often take a more holistic approach to treating health conditions, meaning that they may focus on treating the underlying causes of the condition rather than just treating the symptoms.

### **Treatment Cost**

The second objective that has been addressed is the service quality of Traditional & Complimentary Medicine. The respondents were asked about the treatment cost that can trigger TCM. This study covered 8 respondents, all of the respondents said that TCM is affordable price with treatment. The cost of Traditional and Complementary Medicine (TCM) treatment can vary widely depending on the type of treatment, the practitioner, and the location. In

general, TCM treatments tend to be less expensive than conventional Western medicine treatments, although this may not always be the case. If you're interested in exploring TCM treatment options, it's a good idea to research practitioners in your area, compare costs and services, and check with your health insurance provider or employer to see if TCM treatments are covered.

### **Facility**

The respondents were asked about the facility that can be a predictor of Traditional & Complimentary Medicine. This study discovered eight respondents and all the respondents were satisfied with all facilities provided by the spa. A spa should be in a good location, comfortable and at the same time not cause any damage or danger to health or be close to a place of worship. If the Spa in question operates in the same building where other businesses operate, the Spa area must be marked and labeled clearly (clearly specified) and each area must meet the service standards that have been set. Areas for massage services must not be hidden or obscured. All areas inside and outside the Spa should always be clean and tidy. In addition, the Spa area must also have sufficient lighting to carry out a service and have an adequate ventilation system for the comfort of customers who come to get services. The spa supervisor must provide a clinical waste management system that complies with established standards, ie any waste contaminated with blood or body fluids must be disposed of in a biohazard plastic bag.

### **Practices from Generation to Generation**

The last objective that has been addressed is the knowledge of the treatment that affects customer satisfaction of Traditional & Complimentary Medicine. This study discovered from 8 respondents, 4 respondents have practices from generation to generation of Traditional & Complementary Medicine (TCM). Traditional and Complementary Medicine (TCM) encompasses a range of healing practices that have been passed down from generation to generation in many cultures around the world. These practices often involve the use of natural remedies and therapies to promote healing and balance in the body. In many cases, TCM practices have been developed over hundreds or even thousands of years, with knowledge and techniques passed down through families and communities. For example, traditional Chinese medicine, one of the most well-known forms of TCM, has been practiced for over 2,500 years and has evolved over time to incorporate new knowledge and techniques. Other forms of TCM, such as Ayurvedic medicine from India or traditional healing practices from Africa, have

similarly been passed down through generations and may have different techniques and remedies specific to their cultural traditions. The transmission of knowledge and practices in TCM often involves an apprenticeship model, where a master practitioner passes on their knowledge and techniques to a younger apprentice.

### **Treatments Use Natural Ingredients**

Respondents were asked about the treatments use natural ingredients of Traditional & Complementary Medicine (TCM) is an important part of my thesis. This study discovered from 8 respondents,8 respondents understood the ingredients used by the therapist is very safe to use. One of the key principles of Traditional and Complementary Medicine (TCM) is the use of natural ingredients to promote healing and balance in the body. Many TCM treatments utilize herbs, plants, and other natural substances to create remedies and therapies that are believed to have medicinal properties. Some common natural ingredients used in TCM treatments include herbal remedies, acupuncture, massage therapy and cupping therapy. It's important to note that while natural ingredients used in TCM treatments may be effective for certain health conditions, they can also have side effects and may interact with other medications or health conditions. It's important to always discuss any TCM treatments with a qualified practitioner and to disclose any other medications or health conditions you may have.

### **RECOMMENDATION**

This study makes a few recommendations based on the findings. It is related to the government's action plans. International awareness-raising actions can help national and local initiatives by giving direction and information resources that can be customized to improve the effectiveness of local campaigns. Information campaigns are an important aspect of creating awareness. Target audiences such as the general public, health experts, social workers, and potential users should be identified before initiating a campaign.

Furthermore, the Ministry of Tourism, Arts, and Culture (MOTAC) must oversee skilled TCM treatments in Malaysia in terms of practitioner credentials and certificates to ensure that the treatments done are safe and effective for consumers who come for treatment. This is critical in order to give successful TCM treatment to clients

In addition, TCM treatment practitioners can integrate into hospitals to increase customer happiness and the quality of TCM treatment services since it helps to know more about the precautions in managing clients according to the processes to treat them.

## CONCLUSION

This study aims to examine customer satisfaction with Traditional Complimentary and Medicine (TCM) treatment in Pengkalan Chepa, Kelantan. This research found customer satisfaction in terms of treatment effectiveness, quality of service and customer knowledge of the treatment performed. Data was collected face-to-face using semi-structured interviews among five TCM spas in Pengkalan Chepa Kelantan. This uses purposive sampling and snowball sampling in five TCM spas. Purposive sampling is a spa located in Pengkalan Chepa and the snowball is a customer who seeks treatment at the spa to meet. The data collected from the interviews were analyzed using Thematic Analysis which started familiarizing the data, general start code, finding a theme, reviewing themes, defining and naming themes and generating reports.

## REFERENCES

- Akter, M., Sadekin, M. N., & Patwary, A. K. (2020). An Empirical Study on Students' Satisfaction from Mawlana Bhashani Science & Technology University, Bangladesh. *Review of Economics and Development Studies*, 6(2), 363-379.
- Alisara Arirachakaran, Amnat Sukthuyat, Thaworn Sisayanarane, Sorawut Laoratanavoraphong, Wichan Kanchanatawan & Jatupon Kongtharvonskul. (2016) Platelet-rich plasma versus autologous blood versus steroid injection in lateral epicondylitis: a systematic review and network meta-analysis. *J Orthopaed Traumatol* 17. 101–112.
- Alom, S., Patwary, A. K., & Khan, M. M. H. (2019). Factors affecting the turnover intention of Bangladeshi migrants in the United Arab Emirates: An empirical study on the hotel industry. *International Journal of Innovation, Creativity and Change*, 8(3), 344-360.
- Berretta M., Della Pepa C., Tralongo P., Fulvi A., Martellotta F., Lleshi A., Nasti G., Fisichella R., Romano C., De Divitiis C., Taibi R., Fiorica F., Di Francia R., et al. (2017). Use of Complementary and Alternative Medicine (CAM) in cancer patients: An Italian multicenter survey. 24401-24414.
- D.T. Felson et al. (2000). Osteoarthritis: new insights. Part 1: the disease and its risk factors. *Ann. Intern Med.* <https://doi.org/10.7326/0003-4819-133-8-200010170-00016>

- David D. Cunningham, Timothy P. Henning, Eric B. Shain, Douglas F. Young, Jurgen Hannig, Eric Barua, and Raphael C. (2002). Blood extraction from lancet wounds using vacuum combined with skin stretching.. 92(3).
- Eileen M. Welna, Ronald S. Hadsall. (2003). Pharmacists' Personal Use Professional Practice Behaviors and Perceptions Regarding Herbal and Other Natural Products. *Journal of the American Pharmacists Association*. 43(5). 602-611.
- Ekor, M. (2014). The growing use of herbal medicines: issues relating to adverse reactions and challenges in monitoring safety. *Frontiers in Pharmacology*, 4. <https://doi.org/10.3389/fphar.2013.00177>
- Eran Ben-Arye, Adriaan Visser. (2012). The role of health care communication in the development of complementary and integrative medicine. *Patient Education and Counseling*. 89(3). 363-367.
- Fengmin, Z., Baijun, W., Jiangtao, B., Li, L., & Patwary, A. K. (2022). Investigating revisit intention of medical tourists in China through nutritional knowledge, perceived medical quality, and trust in the physiologist: A recommendation on health tourism policy measures. *Frontiers in Public Health*, 10, 893497.
- Foronczewicz, K. Mucha, J. Gryszkiewicz, M. Florczak, M. Mulka, A. Chmura, J. Szmidt, W. Patkowski, L. Pączek. (2011), Dietary Supplements and Herbal Preparations in Renal and Liver Transplant Recipients. *Transplantation Proceedings*. 43(8). 2935-2937.
- Foroogh Namjooyan, Rahil Ghanavati, Nastaran Majdinasab, Shiva Jokari & Mohammad Janbozorgi. Uses of Complementary and Alternative Medicine in Multiple Sclerosis. *Journal of Traditional and Complementary Medicine*. 2014; Vo1. 4. (3).145 152
- Hazbar, A. M. H., Alem Mohammed, A., & Karim, A. K. A. (2019). An Empirical Study of Factors Influencing hotel customers' online booking Intention. *مجلة العلوم التربوية و الدراسات الإنسانية*, (5), 1-17.
- Jafri MS. (2014). Mechanisms of Myofascial Pain. *Int Sch Res Notices*. 523924. <https://doi.org/10.1155/2014/523924>
- Jan, H. A., Jan, S., Bussmann, R. W., Wali, S., Sisto, F., & Ahmad, L. (2020). Complementary and alternative medicine research, prospects and limitations in Pakistan: A literature review. *Acta Ecologica Sinica*, 40(6), 451–463.
- Kim et al., (2017) Quality of medical service, patient satisfaction and loyalty with a focus on interpersonal-based medical service encounters and treatment effectiveness: a cross-sectional multicenter study of complementary and alternative medicine (CAM) hospitals - *BMC Complementary Medicine and Therapies*. BioMed Central. <https://bmccomplementmedtherapies.biomedcentral.com/articles/10.1186/s12906-017-1691-6>
- Li, L., Ragavan, N. A., Patwary, A. K., & Baijun, W. (2022). Measuring patients' satisfaction toward health tourism in Malaysia through hospital environment, nutritional advice, and perceived value: A study on Chinese exchange students. *Frontiers in public health*, 10, 893439.
- Li, L., Wu, B., & Patwary, A. K. (2022). How marine tourism promote financial development in sustainable economy: new evidences from South Asia and implications to future tourism students. *Environmental Science and Pollution Research*, 29, 1155-1172.
- Li, L., Wu, B., & Patwary, A. K. (2022). The psychosocial factors affecting chinese Outbound Exchange and mobility students' academic performance during COVID-19. *Frontiers in psychology*, 13, 872516.
- Mitchell, M., Williams, J., Hobbs, E., & Pollard, K. (2006). The use of complementary therapies

in maternity services: A survey. *British Journal of Midwifery*, 14(10), 576– 582.

- Patwary, A. K., Roy, B., Hoque, R., & Khandakar, M. S. A. (2019). Process of developing a community based tourism and identifying its economic and social impacts: An Empirical study on Cox's Bazar, Bangladesh. *Pakistan Journal of Humanities and Social Sciences*, 7(1), 1-13.
- Steel, A., McIntyre, E., Harnett, J. et al. (2018). Complementary medicine use in the Australian population: Results of a nationally-representative cross-sectional survey. *Sci Rep* 8, 17325.
- Stein, D. J. (2017). Massage Acupuncture, Moxibustion, and Other Forms of Complementary and Alternative Medicine in Inflammatory Bowel Disease. *Gastroenterology Clinics of North America*, 46(4), 875–880.
- Sumethokula, P., Patwary, A. K., Srinuanpanc, B., Srinuanpand, C., Suwandee, P., Thammathikulf, A., & Phanong, W. (2020). The potential of new tour repackaging for creative tourism among entrepreneurs in Nakhon Si Thammarat. *International Journal of Innovation, Creativity and Change*, 13(10), 1752-1771.
- T E Towheed, L Maxwell, M G Judd, M Catton, M C Hochberg, G Wells. (2006). Acetaminophen for osteoarthritis. *Cochrane Database Syst. Rev.* <https://doi.org/10.1002/14651858.CD004257.pub2>
- Takeda, H. Itoh, H. Tamano, M. Yuzurihara, and N. Oku. (2008). Suppressive effect of Yokukansan on the excessive release of glutamate and aspartate in the hippocampus of zinc-deficient rats. *Nutritional Neuroscience*. vol. 11. no. 1. 41–46.
- Traditional and Complementary Medicine Blueprint: 2018-2027 (Health Care)  
Traditional and Complementary Medicine Division, Ministry of Health Malaysia (2017).
- Wu, B., Liu, S., Wang, J., Tahir, S., & Patwary, A. K. (2021). Assessing the mechanism of energy efficiency and energy poverty alleviation based on environmental regulation policy measures. *Environmental Science and Pollution Research*, 28, 40858-40870.
- Wu, B., Zhai, B., Mu, H., Peng, X., Wang, C., & Patwary, A. K. (2021). Evaluating an economic application of renewable generated hydrogen: A way forward for green economic performance and policy measures. *Environmental Science and Pollution Research*, 1-15.



# UNHEALTHY LIFESTYLE AMONG YOUTH IN KEDAH AND JOHOR

NORAINA NAJIWA BINTI ASFULRIZAL

NORAMIRA HANUM BINTI MOHD NASIR

NUR FARISHA ELYANA BINTI MOHAMAD ASRI

NUR HASNA ZAHIRAH BINTI MOHD ZAKI

---

## ABSTRACT

The present study aimed to assess the association between smoking, short and insufficient sleep, lack of exercise and unhealthy lifestyle among young in Kedah and Johor. A web-based survey was given at Kedah and Johor, with 384 youth responding. The findings support the study's hypotheses that smoking, short and insufficient sleep and lack of exercise substantially impact the unhealthy lifestyle of youth in Kedah and Johor. Therefore, future research should confirm these findings using larger sample size and moderating variables.

**Keywords:** Unhealthy Lifestyle, Smoking, Short and Insufficient Sleep, Lack Of exercise, Youth in Kedah, and Johor

---

## INTRODUCTION

The research being conducted seeks to investigate the factors that contribute to an unhealthy lifestyle among Kedah and Johor's youth. There is evidence that risk factors are responsible for most noncommunicable diseases, which account for one-third of total mortality. Psychosomatic health problems (PHP) are more prevalent among youth who engage in hazardous lifestyle behaviours. The primary predictors of psychosomatic health complaints are hazardous behaviours, inactivity, obesity, poor body image, low self-esteem, a negative perception of health, a diminished sense of coherence, problematic internet use, online gaming for escape purposes, and perceived psychosocial stress. According to the World Health Organisation (WHO), a hazardous lifestyle is characterised by physical inactivity, smoking, a sedentary lifestyle, and alcohol consumption.

In Malaysia, the most prevalent unhealthy lifestyle factor was a lack of regular exercise (33.1%), followed by smoking (6.5%) and excessive alcohol consumption (6.1%). Smoking was associated with a slight increase in the incidence of atrial fibrillation, whereas excessive alcohol consumption did not result in a statistically significant increase. With a prevalence of 23.1% in Malaysia, smoking is the most significant factor of a harmful lifestyle. An unhealthy lifestyle is associated with inactivity, smoking, alcohol consumption, heart disease, obesity, high blood pressure, elevated cholesterol, and type 2 diabetes. Sleep is a risk factor as well.

There were some objectives of this research:

- i. To determine the factors of smoking related to unhealthy lifestyles among youth in Kedah and Johor.
- ii. To examine relationship between short sleep and lifestyles among youth in Kedah and Johor.
- iii. To investigate the relationship between lack of exercise associated with unhealthy lifestyles among youth in Johor and Kedah.

## **SIGNIFICANCE OF THE STUDY**

This study contributes to body knowledge by providing a full understanding of the reasons for unhealthy lifestyle among young in Kedah and Johor by its elaborative literature analysis and empirical data. Second, it improves the researcher's ability to gain a deeper understanding of the factor of unhealthy lifestyles among youth in Kedah and Johor. Unhealthy eating habits are one of the health concerns that can lead to chronic illnesses and death in a person's later years. Aside from the foregoing, the empirical findings of the study will serve as guidelines for Malaysian policymakers in the health and wellness sector. Finally, this study provides guidance for future research in the field of unhealthy lifestyles.

## **LITERATURE REVIEW**

### **UNHEALTHY LIFESTYLE**

A bad lifestyle, on the other hand, could transform a robust individual into a patient. It is a lifestyle characterized by health-damaging behaviors such as skipping breakfast or eating too much or too quickly, drinking too much, or spending too much time in front of the television, smoking, not exercising, eating unhealthy foods, and failing to maintain a healthy weight. In addition, you

are perpetually exposed to thousands of chemicals at work, at home, in the air, and in the food you eat. More than ever, you consume processed and hurried foods. You regularly abuse your body with unnecessary medications (Johnsen, N., 2018).

Cluster headache is among the most excruciating medical conditions known to man. Extreme episodes of unilateral periorbital pain are accompanied by agitation and autonomic symptoms of the head. Observational studies have revealed that cluster headache sufferers have poor lifestyle factors. The most frequently reported problems are excessive smoking and harmful alcohol consumption (Steinberg, 2018). Due to the close association between cluster headaches and smoking, it has been suggested that smoking may play a role in cluster headache onset. In contrast, it has been argued that patients with cluster migraines have psychological characteristics that make them more prone to making poor lifestyle decisions. Men with cluster headache were found to consume more illegal substances, such as cannabis and cocaine, than controls, whereas women showed no difference (Fourier, 2018).

## **SMOKING**

People recognize that, from their own perspective, many people do not embrace a healthy lifestyle due to attitude components of personal, social, and family history, according to Majabadi et al. (2016). This is due to the high number of people who do not live a healthy lifestyle in their daily lives because of external environmental variables that affect them rather than their internal demands and desire to live a healthy lifestyle. As a result of health concerns and ailments, most people adopt harmful lifestyle patterns. For example, 38.7% of smokers who attempted to quit smoking in the previous 12 months, as well as 26.6% of smokers who suffered serious illness in 2018, are concerned about their future health.

## **SHORT AND INSUFFICIENT SLEEP**

Sleep patterns, such as regenerative and undisturbed sleep, sleep onset latency, or how long it takes the person to fall asleep, the number of awakenings during the night, or how many times the person wakes up during the night, and fatigue during daytime concentration, all reflect a person's sleep quality. Insufficient sleep-in youth were identified as a serious health risk in a joint resolution sponsored by the American Medical Association and the American Academy of Sleep Medicine in 2010. Furthermore, one of the objectives for Sleep Health, a new topic in Healthy People 2023, is to reduce adolescent sleep loss: "SH-3: Increase the proportion of students in grades 9–12 who get enough sleep" (defined as  $\geq 8$  hours). Inadequate sleep has been associated with a variety of unfavorable consequences in adolescent health, including physical and mental

health, as well as academic success. Inadequate sleep duration is linked to various cardiometabolic risk factors in children and youth, including dyslipidemia, glucose homeostasis, and high blood pressure, according to Owens J (2014)

## **LACK OF EXERCISE**

Morning, evening, and night activities are encouraged, whereas afternoon sports are discouraged, according to the National Sports Institution (2016). Morning exercise can create a sense of freshness, burn excess fat, enhance energy, and deliver continual calorie burning. Exercising in the morning can burn 420 calories of energy, with an additional 190 calories expended even if you do not move again that morning. This will increase your energy and fitness level, allowing you to participate in a variety of activities later on. If you are unable to exercise first thing in the morning, The National Sports Institution recommends that you exercise in the evenings and at night. Evening and evening sports can aid in the reduction of brain stress and the improvement of physical fitness. One of the reasons Malaysians are at danger of metabolic syndrome, according to Dr Lim Kien Chien, Clinical Cardiologist at the National Heart Institute, is a lack of exercise and bad eating habits.

## **Research Hypothesis**

In this study, there were four hypotheses related to identify unhealthy lifestyle among youth Kedah and Johor.

H1: There is significant relationship between impact of smoking related to media social and unhealthy lifestyle among youth in Kedah and Johor.

H2: There is significant relationship between short sleeps factor can give negative impact and unhealthy lifestyle among youth in Kedah and Johor.

H3: There is significant relationship between lack of exercise associated to unhealthy lifestyle among youth in Kedah and Johor.

## **Research Framework**

A research framework was developed to investigate the relationship between factor and unhealthy lifestyle among youth in Kedah and Johor. The dependent variable is an unhealthy lifestyle among Kedah and Johor youngsters. The proposed independent variable consists of three factors: smoking, short sleeps, and lack of exercise.

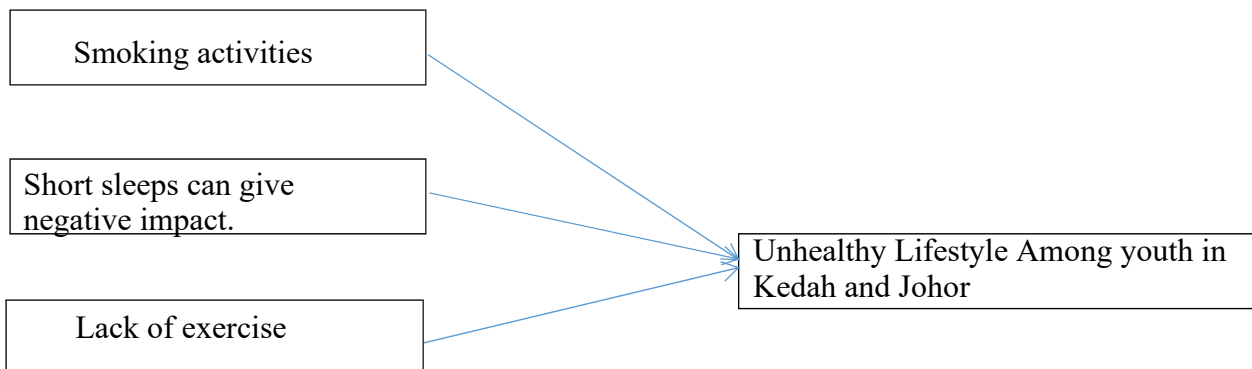

Figure 1: Research Framework of Unhealthy Lifestyle Among Youth in Kedah and Johor.

## **METHODOLOGY**

### **Research Design**

In this research, a quantitative approach was used. As study design, descriptive research design was utilised.

### **Data Collection**

The data collection method was an online questionnaire. 384 adolescents in the Malaysian states of Kedah and Johor were administered a questionnaire via a Google form. The questionnaire is divided into five sections: socio-demographic, unhealthy lifestyle, smoking, brief and insufficient sleep, and lack of exercise.

### **Sampling**

In this research, a sampling method based on convenience was used. Convenience sampling is a non-probability method for selecting study participants.

### **Data Analysis**

For data analysis in this investigation, reliability tests, descriptive analysis, and Pearson Correlation were performed. Using Pearson Correlation, the coefficient relationship between variables was determined. During data analysis, the most recent version of the Software Package for Social Science (SPSS), Statistic 26, was utilised.

## **FINDINGS**

### **I. DESCRIPTIVE**

The socio-demographic of respondents were shown in the Table 1.1. The average gender frequency of respondents is female was 57%. The average by occupational frequency of respondents is students was 77.6%. Majority of respondents that we get were age around 22-24 with 70.3%, meanwhile for the educational level youth with degree is 77.6% and the youth come from Kedah with 38.5%.

Table 1.1: Socio-demographic characteristics of respondents

Socio-demographic characteristic	Frequency (n)	Percentage (%)
Gender		
Female	219	57
Male	165	43
Occupational		
Student	19	77.6
Working	298	17.4
Not working	67	4.9
State		
Johor	147	38.3
Kedah	148	38.5
Others	89	23.2
Level Education		
Degree	294	76.6
Master/ PHD	14	3.6
SPM	37	9.6
Diploma/STPM/STAM/ Foundation	39	10.2
Age		
18-21	73	19.0
22-24	270	70.3
25-28	41	10.7

This research examined the relationship between smoking, short and insufficient sleep, and lack of exercise to unhealthy lifestyle among youth in Kedah and Johor. The questionnaire consisted of 29 questions and 348 respondents answered through Google Form. The results showed that the unhealthy lifestyle correlation was 0.477, suggesting a significant positive impact between unhealthy lifestyle to smoking on social media among youth in Kedah and Johor. Studies found that people who saw social media containing tobacco content were more likely to report using tobacco and more likely to use it in the future. Short sleeps factor had a negative impact on unhealthy lifestyle among youth in Kedah and Johor, with a correlation of 0.510 suggesting a positive significant impacts.

Adequate and required sleep is 8 hours each day. Sleep duration and quality are essential for physical and mental health. Lack of exercise is associated with an unhealthy lifestyle among youth in Kedah and Johor, with a positive significant impact. Being physically active can improve brain health, manage weight, reduce risk of disease, strengthen bones and muscles, and improve ability to do everyday activities.

Table 1.2: The relationship between smoking, short and insufficient sleeps, and lack of exercise with unhealthy lifestyle among youth

<b>Impact unhealthy lifestyle</b>	<b>P-value</b>	<b>(95% CI) (Lower)</b>	<b>(95% CI) (Upper)</b>
Smoking	0.477	0.467	3.447
Short and insufficient sleeps	0.510	0.634	3.914
Lack of exercise	0.316	0.629	4.047

## **DISCUSSION AND RECOMMENDATION**

This topic is very interesting to study. There are some recommendations for prospective researchers so that they can better comprehend the relevant research field. First, the respondent type can be altered to be open to all groups and the entirety of Malaysia. This can assist us in determining the relationship between adolescent knowledge, awareness, and attitudes regarding the effects of unhealthy lifestyles. These studies found that there is a greater consensus that people are aware that smoking is harmful. Researchers analysed



29 previously published studies and found that those who saw tobacco-related content on social media were more than twice as likely to report using tobacco and more likely to use it in the future compared to those who never saw it. It is essential to ensure that social media marketing has a significant impact on consumer behaviour and awareness, especially when attempting to combat a habit such as smoking. Social media marketing plays a significant role for residents and societies when a campaign with effective content is directed to transform consumer behaviour and encourage it to adopt new behaviours.

Furthermore, these studies have revealed that participants are aware that 8 hours of sleep per day is the minimum necessary for quality rest. Length and quality of sleep are essential for physical and mental health. For cancer patients, adequate sleep duration of 7-8 hours is required for physical strength, diurnal vitality, and immune enhancement. The quality of sleep, which refers to the duration and efficiency of slumber, is another crucial factor. Numerous pharmacological and non-pharmacological therapy options are available for enhancing the quantity and character of sleep.

In addition, there was a significant correlation between dearth of exercise and an unhealthy lifestyle among Kedah and Johor youth. Clearly, daily exercise is required to increase our stamina and defend our health from disease. Being physically active can improve mental health, aid in weight management, reduce disease risk, strengthen bones and muscles, and enhance your ability to perform daily tasks. Some health benefits accrue to adults who sit less and engage in any quantity of moderate-to-vigorous physical activity.

## **CONCLUSION**

The aim of this study was to determine the impact that influenced unhealthy lifestyle among youth in Kedah and Johor. In this study unhealthy lifestyle was influenced by lack of exercise youth among Kedah and Johor. The results shows there was association between unhealthy lifestyle and lack of exercise. In conclusion, the finding of this study proven that there was association between lack of exercise and unhealthy lifestyle among youth Kedah and Johor.

## REFERENCES

- Akter, M., Sadekin, M. N., & Patwary, A. K. (2020). An Empirical Study on Students' Satisfaction from Mawlana Bhashani Science & Technology University, Bangladesh. *Review of Economics and Development Studies*, 6(2), 363-379.
- Alom, S., Patwary, A. K., & Khan, M. M. H. (2019). Factors affecting the turnover intention of Bangladeshi migrants in the United Arab Emirates: An empirical study on the hotel industry. *International Journal of Innovation, Creativity and Change*, 8(3), 344-360.
- Baceviciene, M., Jankauskiene, R., & Emeljanovas, A. (2019). Self-perception of physical activity and fitness is related to lower psychosomatic health symptoms in youth with unhealthy lifestyles. *BMC Public Health*, 19(1). <https://doi.org/10.1186/s12889-019-7311->
- Djermani, F., Sulaiman, Y., & Shahril Ismail, M. Y. (2021). The Effect of Product and Promotion on Consumption Patterns with Mediation Effect of Healthy Lifestyle. *WSEAS TRANSACTIONS on ENVIRONMENT and DEVELOPMENT*, 17, 520-532. <https://doi.org/10.37394/232015.2021.17.50>
- Fengmin, Z., Baijun, W., Jiangtao, B., Li, L., & Patwary, A. K. (2022). Investigating revisit intention of medical tourists in China through nutritional knowledge, perceived medical quality, and trust in the physiologist: A recommendation on health tourism policy measures. *Frontiers in Public Health*, 10, 893497.
- Hazbar, A. M. H., Alem Mohammed, A., & Karim, A. K. A. (2019). An Empirical Study of Factors Influencing hotel customers' online booking Intention. *مجلة العلوم التربوية و الدراسات الإنسانية*, (5), 1-17.
- HealthDay. (2022). Social Media Has Big Impact on People Taking Up Smoking, Vaping. *US News & World Report*; *U.S. News & World Report*. <https://www.usnews.com/news/health-news/articles/2022-07-13/social-media-has-big-impact-on-people-taking-up-smoking-vaping#:~:text=By%20analyzing%209%20previously%20published,those%20who%20never%20viewed%20it>
- Kanerva, N., Pietiläinen, O., Lallukka, T., Rahkonen, O., & Lahti, J. (2017). Unhealthy lifestyle and sleep problems as risk factors for increased direct employers' cost of short-term sickness absence. *Scandinavian Journal of Work, Environment & Health*. <https://doi.org/10.5271/sjweh.3695>
- Kokubun, K., Pineda, J. C. D., & Yamakawa, Y. (2021). Unhealthy lifestyles and brain condition: Examining the relations of BMI, living alone, alcohol intake, short sleep, smoking, and lack of exercise with gray matter volume. *PLOS ONE*, 16(7), e0255285. <https://doi.org/10.1371/journal.pone.0255285>
- Li, L., Ragavan, N. A., Patwary, A. K., & Baijun, W. (2022). Measuring patients' satisfaction toward health tourism in Malaysia through hospital environment, nutritional advice, and perceived value: A study on Chinese exchange students. *Frontiers in public health*, 10, 893439.
- Li, L., Wu, B., & Patwary, A. K. (2022). How marine tourism promote financial development in sustainable economy: new evidences from South Asia and implications to future tourism students. *Environmental Science and Pollution Research*, 29, 1155-1172.

- Li, L., Wu, B., & Patwary, A. K. (2022). The psychosocial factors affecting chinese Outbound Exchange and mobility students' academic performance during COVID-19. *Frontiers in psychology*, 13, 872516.
- Low, Y. (2021). Sleep Deprivation and Its Associated Factors Among Undergraduate Students in Malaysia - Rika Naito, Wah Yun Low, Choo Wan Yuen, 2021. *Asia Pacific Journal of Public Health*. <https://journals.sagepub.com/doi/full/10.1177/10105395211019930>
- Mamun, A. A., Hayat, N., & Zainol, N. R. B. (2020). Healthy Eating Determinants: A Study among Malaysian Young Adults. *Foods*, 9(8), 974. <https://doi.org/10.3390/foods9080974>
- Ortiz, C., López-Cuadrado, T., Rodríguez-Blázquez, C., Pastor-Barriuso, R., & Galán, I. (2022). Clustering of unhealthy lifestyle behaviors, self-rated health and disability. *Preventive Medicine*, 155, 106911. <https://doi.org/10.1016/j.ypmed.2021.106911>
- Patwary, A. K., Roy, B., Hoque, R., & Khandakar, M. S. A. (2019). Process of developing a community based tourism and identifying its economic and social impacts: An Empirical study on Cox's Bazar, Bangladesh. *Pakistan Journal of Humanities and Social Sciences*, 7(1), 1-13.
- Sumethokula, P., Patwary, A. K., Srinuanpanc, B., Srinuanpand, C., Suwandee, P., Thammathikulf, A., & Phanong, W. (2020). The potential of new tour repackaging for creative tourism among entrepreneurs in Nakhon Si Thammarat. *International Journal of Innovation, Creativity and Change*, 13(10), 1752-1771.
- Tambalis, K. D., Panagiotakos, D. B., Psarra, G., & Sidossis, L. S. (2018). Insufficient Sleep Duration Is Associated With Dietary Habits, Screen Time, and Obesity in Children. *Journal of Clinical Sleep Medicine*, 14(10), 1689–1696. <https://doi.org/10.5664/jcsm.7374>
- Tan, S. T., Tan, C. X., & Tan, S. S. (2022). Changes in Dietary Intake Patterns and Weight Status during the COVID-19 Lockdown: A Cross-Sectional Study Focusing on Young Adults in Malaysia. *Nutrients*, 14(2), 280. <https://doi.org/10.3390/nu14020280>
- Wu, B., Liu, S., Wang, J., Tahir, S., & Patwary, A. K. (2021). Assessing the mechanism of energy efficiency and energy poverty alleviation based on environmental regulation policy measures. *Environmental Science and Pollution Research*, 28, 40858-40870.
- Wu, B., Zhai, B., Mu, H., Peng, X., Wang, C., & Patwary, A. K. (2021). Evaluating an economic application of renewable generated hydrogen: A way forward for green economic performance and policy measures. *Environmental Science and Pollution Research*, 1-15.

# **The Factors That Influence Sleep Quality Among Students Universiti Malaysia Kelantan (UMK), City Campus**

**Kogila A/P Murugan, Nur Fatiehah Natasya Syamsul, Che Muhammad Danial Che  
Ibrahim, Nur Rindiani Munaya Nazran & \*Dr. Normaizatul Akma Saidi**

*Faculty of Hospitality, Tourism and Wellness, Universiti Malaysia Kelantan Corresponding  
email: [akma.s@umk.edu.my](mailto:akma.s@umk.edu.my)*

---

## **ABSTRACT**

**Purpose:** To review the factors that influence sleep quality among students Universiti Malaysia KELANTAN (UMK), City Campus.

**Method:** A cross-sectional study was conducted among FHPK students at Universiti Malaysia Kelantan, City Campus. The sociodemographic data were obtained from a simple random sampling that take 365 of random students, age range from 18 to 30 years and above, including both genders. All participants completed six sections of questionnaires. A questionnaire was evaluated to identify the quality of sleep among students at Universiti Malaysia Kelantan, City Campus. Analyses were conducted with Statistical Package Social Sciences (SPSS) version 26.

**Result:** There are many studies that have been identified to be classified according to the investigated factors of sleep quality. Physical factors and lifestyle are healthy factors that improve sleep quality, while mental health and social factors reduce sleep quality.

**Conclusion:** University students are exposed to different risk factors for sleep quality. When designing interventions to improve sleep quality among university students, each of these factors needs to be addressed.

**Keywords:** Quality Sleep, Lifestyle, Mental Health, Social, and Physical Factors

---

## **INTRODUCTION**

According to research, sleep is a crucial mental state for preserving vitality and regaining physiological function. The quality of sleep has a significant influence on health and is regarded as a major public health issue. (Ruiz-Zaldibar et al., 2022). According to (Nelson et al., 2022), there are five factors that influence sleep quality which are sleep disruption, actual sleep, or how long it takes for someone to go from being awake to falling asleep, sleep duration in 24 hours, and waking after sleep onset, or how long it takes for someone to become fully awake. This proportion of total sleep time to total time in bed is known as sleep efficiency.

A good night's sleep is a good measure of one's overall health, including both mental and physical well-being. However, studies have shown a link between inadequate sleep quality, as indicated by a bad subjective sense of sleep, sleep start timings, shorter sleep, and difficulties balancing sleep and daily activities, and psychiatric disorders like stress, panic, and cognitive challenges, as well as decreased physical health, premature aging, and lower productivity at work (Chandler et al., 2022).

There were four objectives of this research:

1. To identify the relationship between lifestyle and sleep quality among students at Universiti Malaysia Kelantan, City Campus.
2. To analyze the relationship between mental health and sleep quality among students at Universiti Malaysia Kelantan, City Campus
3. To analyze the relationship between social factors and sleep quality among students at Universiti Malaysia Kelantan, City Campus
4. To identify the relationship between physical factors and sleep quality among students at Universiti Malaysia Kelantan, City Campus

### **Significance Of the Study**

The purpose of this study is to shed new light on this evidence through an investigation of the relationship between lifestyle, mental health, social factors, physical factors, and quality of sleep among university students. The health authorities will also play an appropriate role as

this study has opened the minds and opportunities for the food industry as well as the public to do detailed research based on the factors available to serve as a guide in the study.

## **LITERATURE REVIEW**

### **Sleep Quality**

According to Nelson, Davis, and Cobbert (2021), a person's satisfaction with each aspect of their sleep experience determines the quality of their sleep. The four elements of restful sleep are sleep efficiency, sleep latency, sleep length, and awakening after sleep begins. Sleep quality and outcomes for both physical and mental health are strongly correlated. Due to both biological and social factors, a person's sleep quality changes over the course of their life.

This sleep latency represents the amount of time it takes you to fall asleep. If you fall asleep in 30 minutes or less when you go to sleep, your sleep is probably of high quality. Sleep latency, sometimes referred to as sleep onset latency, is the length of time it takes for someone to fall asleep after turning out the lights. A healthy person typically needs between 10 and 20 minutes to fall asleep. Sleep latency below eight minutes is quite brief, even though every person's sleep pattern is different (Pacheco, 2022).

### **Lifestyle**

One of the key elements affecting students' sleep quality is lifestyle. According to the WHO, lifestyle factors account for 60% of the variables affecting a person's health and quality of life. This is because smoking and alcohol drinking, participating in physical activities, unhealthy eating habits and excessive media habits affect the sleep quality of students every day. Excessive media use habits are also related to unhealthy lifestyles. Young people's addiction to social media is a significant problem that has had devastating outcomes. While regularly using a smartphone and monitoring social media is acceptable, excessive use reduces efficiency (Simplilearn, 2022).

### **Mental Health**

Mental health is one potential element that might have an impact on the quality of sleep that University of Malaysia Kelantan (UMK), City Campus students get. According to WHO Director-General Dr. Tedros Adhanom Ghebreyesus, the 13th General Programme of Work (GPW13), which covers 2019–2023, has designated mental health for immediate implementation. Acting now will help communities and individuals achieve the highest degree of health, which is only possible when people's rights are upheld, their mental health and well-

being are guaranteed, and their mental health is given the attention it deserves. This is so that everyone can have the best possible mental health and well-being (WHO Special Initiative for Mental Health, 2022). According to a recent survey by The American College Health Association, 36% of all students are mentally weary in 2019, despite the fact that 36% of Americans attend institutions. For instance, a study conducted by Jizan University in Saudi Arabia on medical students revealed that stress was common (71.9%), with women reporting higher levels of stress than men (64%), on average.

### **Social Factor**

Social factors are one of the possible variables that might affect the quantity of sleep among students at Universiti Malaysia Kelantan (UMK), City Campus. Social determinants of health include factors including socioeconomic status, education, access to healthcare, and physical and occupational conditions. Social issues that are associated to health must be addressed if health is to improve and persisting inequities in health and healthcare are to be reduced (Artiga & Hinton, 2018).

### **Physical Factor**

Physical factors are one of the key elements that affect how well students at Universiti Malaysia Kelantan's City Campus sleep. Pain is defined as an unpleasant feeling, such as one that throbs, aches, or pinches. Pain can lower the quality of your sleep by making it harder for you to fall asleep or causing you to wake up in the middle of the night. The most common causes of suffering include arthritis, backaches, and neck pain. If you experience pain that keeps you from falling asleep, invest in a mattress with the highest level of support so that your spine maintains a healthy alignment. Proper spine alignment is one of the best ways to prevent pain from arising or escalating. Joint discomfort is a prevalent symptom of arthritis. In light of this, a mattress with pressure-relieving materials like memory foam ought to be advantageous for them (Zwarenstejn, 2022).

### **Research Hypothesis**

There were four hypotheses in this study that tried to identify the factors influencing students at Universiti Malaysia Kelantan's City Campus's quality of sleep.

Hypothesis 1: There is a significant relationship between lifestyle that influence sleep quality among student in Universiti Malaysia Kelantan, City Campus.

Hypothesis 2: There is a significant relationship between mental health influencing sleep quality among students at Universiti Malaysia Kelantan, City Campus.

Hypothesis 3: There is a significant relationship between social factors that influence sleep quality among university students at Universiti Malaysia Kelantan, City Campus.

Hypothesis 4: There is a significant relationship between physical factors that influencesleep quality among university students at Universiti Malaysia Kelantan, City Campus.

### Research Framework

To explore the relationship between lifestyle, mental health, social factors, and physical factors towards sleep quality among students at Universiti Malaysia Kelantan, City Campus, a research framework has been provided. The independent variables are lifestyle, mental health, social factors, and physical factors. The dependent variable is sleeping quality among student universities in Universiti Malaysia Kelantan, City Campus.

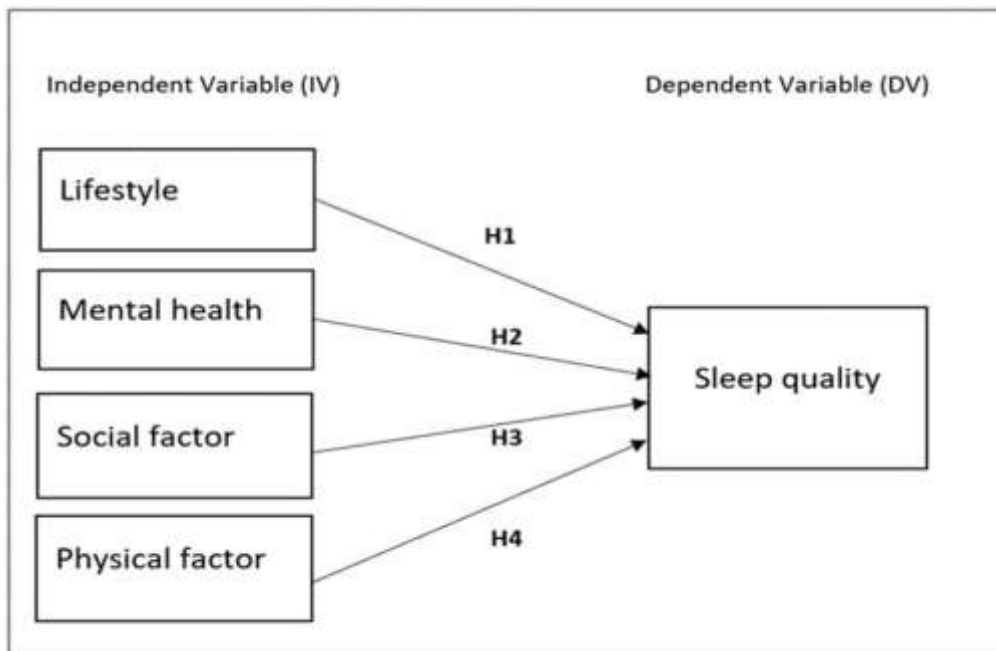

Figure 1: Conceptual Framework

## METHODOLOGY

### Research Design

In this research, a quantitative methodology was used. The data collection method used was cross-sectional research.

### Data Collection

An online questionnaire was used to gather the data. All FHPK students at Universiti Malaysia Kelantan, City Campus, were given the questionnaire that was distributed on Google



Forms as a platform for collecting data. The questionnaire consisted of six sections which are demographic profile, lifestyle, mental health, social factors, physical factors, and sleep quality for parts A, B, C, D, E, and F respectively.

### **Sampling**

In this research, a simple random sampling methodology was chosen. Simple random sampling uses probability sampling to choose the study's respondents as its sampling unit. The sample size for this study was calculated using an equation from Krejcie & Morgan (1970) to get a valid and trustworthy sample. According to Krejcie & Morgan (1970), researchers selected 365 randomly chosen students from the Faculty of Hospitality, Tourism and Wellness (FHPK) at Universiti Malaysia Kelantan, City Campus as the proper sample size for this study.

### **Data Analysis**

In order to analyse the data, this study uses three distinct types of data: descriptive statistics, reliability tests, and Pearson correlation tests. The most recent software programme, Statistical Package Social Sciences (SPSS) version 26 was used to analyse the data in order to determine the link between the independent variables and dependent variables.

## FINDINGS

### Demographic Analysis

Table 1: Demographic Profile

Demographic	Categories	Frequency	Percentage
Gender	Male	212	58.1
	Female	153	41.9
Race	Malay	283	77.5
	Chinese	58	15.9
	Indian	22	6.0
	Others	2	0.5
Age	18-21 years old	120	32.9
	22- 25 years old	242	66.3
	26-29 years old	3	0.8
	30 years and above	0	0
Marital Status	Single	363	99.5
	Married	2	0.5
Religion	Muslim	297	81.4
	Buddha	44	12.1
	Hindu	22	6.0
	Others	2	0.5
Education Level	Diploma	19	5.2
	Degree	344	94.2
	Master	0	0
	Others	2	0.5
Year of Education	1 <sup>st</sup> year	132	36.2
	2 <sup>nd</sup> year	40	11.0
	3 <sup>rd</sup> year	74	20.3
	4 <sup>th</sup> year	119	32.6

Out of 365 respondents, table 1 shows the respondent's profile. Majority of the respondents were male and female where males were 58.1% and females at 41.9% overall. Meanwhile, in terms of race, most of the Malay. 77.5% and followed by China as much 15.9%. Next is India as much as 6.0% and others as much 0.5%. in terms of the respondents by age, for 18-21 years old by 32.9% and for 22-25 years old 66.3% while for 26-29 years old by 0.8% and for 30 years and above was 0%. Next is the respondent to marital status. For those with single status it is 99.5% and for those who marry it is 0.5%. For Religion, the Malay were 81.4% and for Buddha at 12.1% and followed by Hindu at 6.0% and for others at 0.5%. in terms of respondents by educational level, out of 365 respondents. Diploma at 5.2% and for degrees by 94.2% while for bachelor Master by 0% and for others by 0.5%. For Year OF Education was selected from year 1 to year 4, for year 1 by 36.2 percent and for the second year by 11.0% while for year 3 20.3% of respondents answered and for year 4 by 32.6 percent of respondents. This statistic nearly represents the actual demographic tabulation awareness of the Factors That Influence Sleep Quality Among Students University Malaysia Kelantan (UMK), City Campus

### **Descriptive Analysis**

Variable	Items	Mean Score	Standard Deviation
Lifestyle	Is smoking regularly affect the duration of sleep?	3.95	0.923
	Does using media such as phones, laptops, tabs for long hours effect the satisfaction of sleep every day?	3.95	1.000
	Are you involved in extracurricular activities regularly?	3.04	0.863
	Are you craving for high calorie food regularly?	3.80	0.973
	Are you experiencing drastic changes in body weight in the past 1 year?	3.60	1.145
Mental Health	Do you feel the anxiety regularly?	3.18	0.961
	Are you having headaches more regularly?	3.11	0.899
	How often you had experience panic attacks during sleep time?	2.74	0.990
	Do you experience anger more regularly	3.13	0.902
	Does feeling sad make you sleep late?	3.24	0.989

Social Factors	Is that you overthink your studies which make you feel awake for long hours?	3.87	0.949
	Are you going late to class regularly?	2.61	1.098
	Are financial issues of the family make you have poor sleep quality every day?	3.38	1.006
	Is that financial strain includes difficulty covering daily expenses leading to poor quality of sleep?	3.43	1.021
	Is that your interpersonal interaction such as aggressive behaviour affect sleep quality?	2.94	0.939
Physical Factors	Do you often suffer from back pain, and it affects your sleep pattern?	3.75	1.013
	Are you consuming sleep medication regularly to get enough sleep every day?	2.44	1.148
	Are you having any chronic illnesses which disturb your sleeping routine?	2.60	1.043

	Are you having musculoskeletal pain more regularly?	2.86	1.052
	Do you have any neuropathic disease that disturbs your sleep?	2.57	1.086
Sleep Quality	Are you always excessively sleepy during the day?	3.12	1.052
	My sleep quality is good every day.	3.54	0.956
	My amount of sleep is sufficient	3.53	1.042
	My sleep was restless.	2.98	0.984
	I had difficulty falling asleep	3.21	1.071

Results of the descriptive analysis are shown in Table 2. The result aimed to assess the frequency, mean, and standard deviation of various items used to measure various aspects of sleep quality. The Lifestyle items had a mean range of 3.04 to 3.95, with a standard deviation of 0.863 to 1.145. The highest mean values were observed for items L1 and L2 on the questions 'Is smoking regularly affect the duration of sleep?' and 'Does using media such as phones, laptops, tabs for long hours affect the satisfaction of sleep every day?'. The lowest mean was found for items L3 on the questions 'Are you involved in extracurricular activities regularly?'. The Mental Health items had a mean range of 2.74 to 3.24, with a standard deviation of 0.899 to 0.989. The highest mean value was for item MH5, which asked if feeling sad makes you sleep late. Out of 322 respondents, 165 strongly agreed and agreed on item MH5. The lowest mean value was for items MH3 on the question 'How often you had experience panic attacks during sleep time?'. The Social Factors items had a mean range of 2.61 to 3.87, with a standard deviation of 0.949 to 1.098. The highest mean value was for item SF1 on the question 'Is that you overthink your studies which make you feel awake for long hours?', followed by PF1 on the question 'Do you often suffer from back pain, and it affects your sleep pattern?' and PF2 on the question 'Are you consuming sleep medication regularly to get enough sleep every day?'. The Sleep Quality items had a mean range of 2.98 to 3.54, with the highest mean for item SQ2 on the statement 'My sleep quality is good every day'. The lowest mean was for item SQ4 on the statement 'My sleep was restless', with 29.3% of respondents strongly disagreeing and disagreeing on item SQ4. Overall, the study provided valuable insights into the factors affecting sleep quality and overall sleep quality.

### Reliability Analysis

Table 3: Reliability Analysis

Variable	Number of items	Cronbach's Alpha Coefficient
Lifestyle	5	0.633
Mental Health	5	0.821
Social Factors	5	0.668
Physical Factors	5	0.751
Sleep Quality	5	0.296

Table 3 shows the results of the reliability test. High internal consistency for all questionnaires used for this study had been demonstrated (Cronbach's  $\alpha$  ranging from 0.296 to 0.821 alpha coefficients). Reliability analysis which ranged by lifestyle, mental health, social factors, physical factors, and quality sleep (0.633, 0.821, 0.668, 0.751 and 0.296). In measuring the variables that influence lifestyle, mental health, social factors and physical factors, the result of Cronbach's Alpha has shown that the coefficient obtained from the Likert- Scale is reliable. But for variables that influence quality sleep has shown that it is not reliable for this study.

### Pearson Correlation Analysis

Table 4: Results of Pearson Correlation Analysis

Pearson Correlation	Sleep Quality	Lifestyle	Mental Health	Social Factor	Physical Factor
Sig (2-tailed)		.000	.000	.000	
Sleep Quality	1				
Lifestyle	0.315	1			
Mental Health	0.450	0.292	1		
Social Factor	0.483	0.471	0.615	1	
Physical Factor	0.531	0.140	0.559	0.487	1

\*\* Correlation is significant at the 0.01 level (2- tailed)



Table 4 shows the objective of this analysis is to study the relationship between lifestyle, mental health, social factors, physical factors, and sleep quality among students at FHPK University Malaysia Kelantan is low positive, with a Pearson Correlation value of 0.315. This indicates a low positive correlation between lifestyle and sleep quality, with a statistically significant effect at a 0.000% level. Mental health has a low positive correlation of 0.450, with a 0.0000% level of effect. Social factors have a low positive correlation of 0.483, with a 0.0000% level of effect. Physical factors have a low positive correlation of 0.531, with a 0.0000% level of effect. Overall, the relationship between lifestyle, mental health, social factors, physical factors, and mental health at FHPK University Malaysia Kelantan is not strong, suggesting that more research is needed to better understand the factors influencing sleep quality and overall well-being among students.

## **DISCUSSION AND RECOMMENDATION**

Studying this topic is quite interesting. For students in the future to have a better understanding of linked subject fields, they offer some recommendations for those who will follow them. This advice and suggestions may help future research by other academics.

First, the respondents' categorization could be changed to exclude people from a certain region near Kota Bharu, Kelantan. The questionnaire that was previously sent garnered 365 responses. This can help us understand how sleep quality, mental health, social factors, physical factors, and lifestyle factors are related.

The scope of the questionnaire may also be widened, and it might not simply be limited to the students in Kota Bharu, Kelantan. The results of the questionnaire will be more detailed and precise if this is done.

Second, future studies should give questionnaires more time to circulate so that researchers may find people who are better suited and equipped to respond. For instance, with a sample size of 365 respondents, it is difficult to finish data collecting in a short amount of time. Afterward, researchers may clarify the questions or the goal of the study to respondents if they have any difficulties comprehending. To prevent responders from just giving the questions and answers, this is crucial. The researchers may need to offer additional clarity and explication to obtain more accurate and trustworthy data.

The last piece of guidance for potential researchers is to become familiar with analysis tools like SPSS, which is what we do. SPSS (a statistical tool for the social sciences) was used to analyze the replies, or as we might refer to them, the specifics of the respondents' input. Because there are no recommendations for the most effective methods of data analysis, learning how to utilize SPSS requires a lot of study. The assessment assumes a significant role after the data have been summarized and analyzed. The analytical system that will be utilized for future researchers' study should be properly reviewed and understood.

## CONCLUSION

The purpose of this study is to identify the factors affecting students at University Malaysia Kelantan's (UMK) City's sleep quality. We used the IV and DV methodologies in this study, where IV stands for lifestyle, mental health, social component, and physical element. The findings imply a connection between the issues students have with their sleep and those problems. The results of this study demonstrate that a variety of factors influence students at the University Malaysia Kelantan (UMK) city campus's ability to get a good night's sleep.

## REFERENCES

- Akter, M., Sadekin, M. N., & Patwary, A. K. (2020). An Empirical Study on Students' Satisfaction from Mawlana Bhashani Science & Technology University, Bangladesh. *Review of Economics and Development Studies*, 6(2), 363-379.
- Alom, S., Patwary, A. K., & Khan, M. M. H. (2019). Factors affecting the turnover intention of Bangladeshi migrants in the United Arab Emirates: An empirical study on the hotel industry. *International Journal of Innovation, Creativity and Change*, 8(3), 344-360.
- Chandler, L., Patel, C., Lovecka, L., Gardani, M., Walasek, L., Ellis, J., Meyer, C., Johnson, S., & Tang, N. K. Y. (2022b). Improving university students' mental health using multi-component and single-component sleep interventions: A systematic review and meta-analysis. *Sleep Medicine*. <https://doi.org/10.1016/j.sleep.2022.09.003>
- Fengmin, Z., Baijun, W., Jiangtao, B., Li, L., & Patwary, A. K. (2022). Investigating revisit intention of medical tourists in China through nutritional knowledge, perceived medical quality, and trust in the physiologist: A recommendation on health tourism policy measures. *Frontiers in Public Health*, 10, 893497.
- Hazbar, A. M. H., Alem Mohammed, A., & Karim, A. K. A. (2019). An Empirical Study of Factors Influencing hotel customers' online booking Intention. *مجلة العلوم التربوية و الدراسات الإنسانية*, (5), 1-17.
- Li, L., Ragavan, N. A., Patwary, A. K., & Baijun, W. (2022). Measuring patients' satisfaction toward health tourism in Malaysia through hospital environment, nutritional advice, and perceived value: A study on Chinese exchange students. *Frontiers in public health*, 10, 893439.

- Li, L., Wu, B., & Patwary, A. K. (2022). How marine tourism promote financial development in sustainable economy: new evidences from South Asia and implications to future tourism students. *Environmental Science and Pollution Research*, 29, 1155-1172.
- Li, L., Wu, B., & Patwary, A. K. (2022). The psychosocial factors affecting chinese Outbound Exchange and mobility students' academic performance during COVID-19. *Frontiers in psychology*, 13, 872516.
- Nelson, K. L., Davis, J. E., & Corbett, C. F. (2021). Sleep quality: An evolutionary concept analysis. *Nursing Forum*, 57(1). <https://doi.org/10.1111/nuf.12659>
- Onen, S. H., Onen, F., Courpron, P., & Dubray, C. (2005). How Pain and Analgesics Disturb Sleep. *The Clinical Journal of Pain*, 21(5), 422–431. <https://doi.org/10.1097/01.ajp.0000129757.31856.f7>
- Organization, W. H. (2019b). The WHO special initiative for mental health (2019-2023): universal health coverage for mental health. *Apps.who.int*. <https://apps.who.int/iris/handle/10665/310981>
- Pacheco, D. (2021b, August 26). *How Sleep Latency Impacts the Quality of Your Sleep*. Sleep Foundation. <https://www.sleepfoundation.org/how-sleep-works/sleep-latency>
- Patwary, A. K., Roy, B., Hoque, R., & Khandakar, M. S. A. (2019). Process of developing a community based tourism and identifying its economic and social impacts: An Empirical study on Cox's Bazar, Bangladesh. *Pakistan Journal of Humanities and Social Sciences*, 7(1), 1-13.
- Poulsen, A. H., Raaschou-Nielsen, O., Peña, A., Hahmann, A. N., Nordsborg, R. B., Ketznel, M., Brandt, J., & Sørensen, M. (2019). Impact of Long-Term Exposure to Wind Turbine Noise on Redemption of Sleep Medication and Antidepressants: A Nationwide Cohort Study. *Environmental Health Perspectives*, 127(3), 037005. <https://doi.org/10.1289/ehp3909>
- Sumethokula, P., Patwary, A. K., Srinuanpanc, B., Srinuanpand, C., Suwandee, P., Thammathikulf, A., & Phanong, W. (2020). The potential of new tour repackaging for creative tourism among entrepreneurs in Nakhon Si Thammarat. *International Journal of Innovation, Creativity and Change*, 13(10), 1752-1771.
- World Health Organization. (2022, June 16). *World mental health report: Transforming mental health for all*. [Www.who.int. https://www.who.int/publications/i/item/9789240049338](https://www.who.int/publications/i/item/9789240049338)
- World Health Organization. (2022, June 16). *World mental health report: Transforming mental health for all*. [Www.who.int. https://www.who.int/publications/i/item/9789240049338](https://www.who.int/publications/i/item/9789240049338)
- Wu, B., Liu, S., Wang, J., Tahir, S., & Patwary, A. K. (2021). Assessing the mechanism of energy efficiency and energy poverty alleviation based on environmental regulation policy measures. *Environmental Science and Pollution Research*, 28, 40858-40870.
- Wu, B., Zhai, B., Mu, H., Peng, X., Wang, C., & Patwary, A. K. (2021). Evaluating an economic application of renewable generated hydrogen: A way forward for green economic performance and policy measures. *Environmental Science and Pollution Research*, 1-15.

## **MENTAL HEALTH AMONG STUDENTS OF THE UNIVERSITI MALAYSIA KELANTAN, KAMPUS KOTA**

Mastura Binti Mohd Razali , Nur Fatin Afini Binti Md Fua'ad , Nur Sharmimi Eliya Binti Anuar,  
Nur Syuhaila Binti Mohd Salleh & Dr. Maizatul Akma Binti Saidi  
Faculty Of Hospitality, Tourism And Wellness, University Malaysia Kelantan  
Corresponding Email: [akma.s@umk.edu.my](mailto:akma.s@umk.edu.my)

### **ABSTRACT**

Learning may be hampered by students' mental health. It is critical that we understand how to effectively serve this demographic given the rising number of complaints of mental health issues among university students so that they can learn and achieve. Given the plethora of evidence demonstrating how mental illness can impede academic achievement and degree persistence, this is very significant. There are numerous types of help that can be offered in the classroom, incorporated into current practises and learning opportunities for all children worldwide, to better serve this rising group. This article discusses the connection between learning and mental health, along with practical implications and future research objectives.

**Keywords: Mental health, psychosocial, moral support, academic performance**

### **INTRODUCTION**

When someone can work well, contribute to society, manage stress well, and has confidence in their own abilities, they are in a state of good mental health. The World Health Organisation (WHO) defines health as a condition that includes one's physical, mental, and social well-being and extends beyond simply being free from disease. To function normally, people must all have adequate mental health. There are numerous categories for dividing up mental health problems like anxiety, depression, and eating disorders.

University students are a group that is more susceptible to mental disease, claims Nsereko ND. (2018). Although the prevalence of mental health issues among students is not a recent development, students may suffer if the matter is ignored (Abdul Rahid, 2021). In terms of academic, environmental, social, and psychological adjustment in a new environment, continuing studies is challenging for students, according to Yikealo (2018), and this will impair psychosocial wellbeing and student learning results.

According to the Royal Malaysian Police, there were 1708 suicide cases in Malaysia between January 2019 and May 2021. 872 of those incidents involved minors between the ages of 15 and 18. This demonstrates that children and teenagers made up up to 51% of all suicide cases in Malaysia at the time

The Mental Health research from 2019 shows that among the 5.5 million youth in this country, at least one in ten (or 10 percent) have had suicidal thoughts. In addition, 1 in 5 adolescents experience depression, and 1 in 10 teenagers experience stress. This situation is quite concerning because it demonstrates the seriousness of the mental health issues that young people and teenagers are experiencing.

## **SIGNIFICANCE OF THE STUDY**

The University of Malaysia Kelantan (UMK) Kota Campus's FHPK students' mental health factors are addressed in this study. By illuminating the connection between moral support, psychosocial behaviour, academic performance, and mental health among students, this study contributes to the body of knowledge. This research will act as a manual for policy makers in Malaysia's health and wellness sector on how to manage issues relating efficiently and effectively to mental health.

## **LITERATURE REVIEW**

### **Mental health**

A dynamic internal balance that enables people to use their skills in keeping with society's broader goals is the concept of mental health. Basic cognitive and social skills, the ability to recognise, express, and control one's own emotions as well as empathise with others, flexibility and the ability to deal with unfavourable life events and fulfil social roles, as well as a harmonious connection between body and mind, are all significant aspects of mental health that, to varying degrees, contribute to the state of internal equilibrium.

### **Moral support**

A person's life depends on moral support, particularly from family, friends, and even intimate acquaintances. This is since for us to continue to be excited about pursuing or attaining what we desire in life, as human beings, we need the support and encouragement of others. They require moral support as a student to maintain motivation and get good achievements in their studies. All parties must take student mental health concerns seriously since strong social support can shield pupils from mental health challenges.

### **Psychosocial**

According to Foubert and Grainger (2006), this psychosocial development has encompassed components of behaviour and individual attitudes from a person's personal, interpersonal, physical, and psychological dimensions. A person's attitude and mindset can also be impacted by the changes in our environment. A learner will be negatively impacted by this. Extreme pressure that results from this emotional disturbance's impacts can also lead to psychological issues in a person. University students typically experience an upsurge in mental health problems, which affects their stage of life.

### **Academic performance**

Since academic issues now divert students' attention from performance, academic performance among university students at UMK Campus Kota happens. Because it is challenging to find the drive to study and because of these issues, academic performance is primarily a problem for pupils. However, poor academic achievement can impact a person's physiological health, impairing their personality, abilities, and social skills. These papers talk about the relationship between academic success and mental health.

## Research Hypothesis

The research's concept is based on study variables such moral support, psychosocial functioning, and academic performance that influence the mental health of students at UMK.

H1: There is a relationship between moral support with mental health among students UMK Kampus Kota.

H2: There is a relationship between psychosocial with mental health among students UMK Kampus Kota.

H3: There is a relationship between academic performance with mental health among students UMK Kampus Kota.

## Research Framework

For the purpose of examining the relationships between academic success, psychological well-being and moral support and mental health among UMK campus Kota students, a research framework has been illustrated. Academic performance, psychological support, and moral support are the independent factors. The dependent variables are the students at the UMK campus in Kota's mental health.

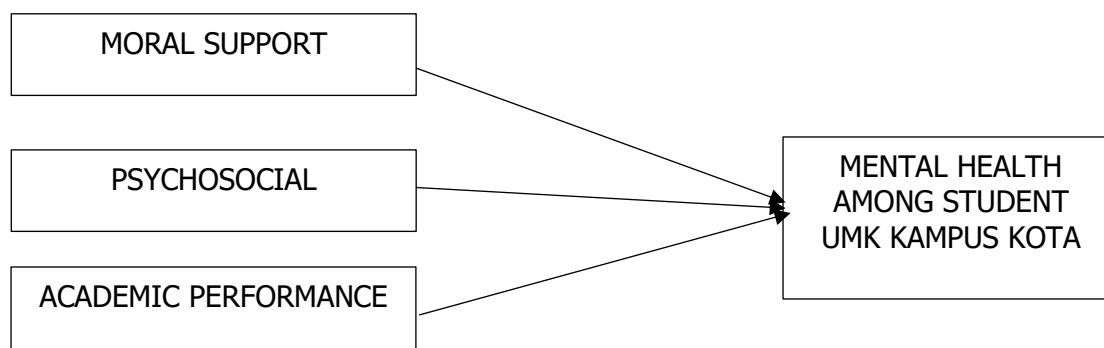

Figure 1: research framework of Mental Health Among UMK Campus Kota Student

## METHODOLOGY

### Research Design

This study employed a cross-sectional study design and a quantitative methodology.

### Data Collection

The process of gathering information for the specified variables in a systematic fashion is known as the data collection method. Primary data will be used in this study, and data will be gathered using an online survey that will be given to University Malaysia Kelantan students who have been chosen at random. Six components, including a socio-demographic portion, section A, section B, section C, section D, and finally open questions, make up the questionnaire.

## Sampling

The sample method used for this investigation was simple random sampling, a type of probability sampling. Using simple random selection, the researcher chooses participants from a population at random. Everyone in the population has the same chance of being chosen. Then, data is collected from as many members of this subset that was randomly selected as is practical. The researchers computed the sampling in order to obtain a valid and trustworthy sample for this experiment using the Krejcie & Morgan Table.

## Data Analysis

Reliability analysis, descriptive analysis, Pearson Correlation analysis, hypothesis testing, and summary are all covered in this chapter. At FHPK students in UMK Kampus Kota, 179 respondents received a total of 22 questionnaires. Prior to administering the actual test questionnaire, a pilot test was carried out using SPSS to analyse the results.

## FINDINGS

Socio-demographic characteristic	Frequency (n)	Percentage(%)
Gender:		
Male	53	29.6%
Female	126	70.4%
Age:		
5.21 years old	55	30.7%
22- 24 years old	114	63.7%
25-27 years old	7	3.9%
29-30 years old	3	1.7%
Race:		
Chinese	9	5%
Indian	10	5.6%
Malay	158	88.3%
Others	2	1.1%
Course:		

SAH	29	16.2%
SAP	72	40.2%
SAS/SAW	78	43.6%

TOTAL (respondents)	179	100%
---------------------	-----	------

The reliability test for accuracy and repeatability was conducted with 179 random participants. The coefficient is good and excellent, with Moral support having 0.685, Psychosocial 0.785, Academic Performance 0.646 and Mental Health 0.635. When the score is more than or equal to 0.5, the survey may be administered according to the rule of thumb.

An essential analysis used to gauge the strength of the linear relationship between the independent variables (IV) and the dependent variable (DV) is the Pearson correlation coefficient analysis. With  $r = 0.347$ ,  $p < 0.01$ , the findings revealed a substantial correlation between moral support and mental health. Mental and psychosocial well-being, with  $r = 0.290$ ,  $p < 0.01$ . Additionally, there is a strong association ( $r = 0.296$ ,  $p < 0.01$  strongly positive) between academic ability and mental health.

## DISCUSSION AND RECOMMENDATION

The research had shown that the variables which are mental health (dependent variable) and moral support, psychosocial and academic performance (independent variable) were correlated with the dependent variable and have low negative correlation relationship. For the future research regarding this topic is highly recommended to adopt a mix method approach which is the combination of quantitative and qualitative methods rather than the qualitative method alone to collect data from respondents. This combination method will enhance the depth and width of the research information.

The future research also suggested increasing the number of the sample size to a wider population across Malaysia to ensure the generalisation of the research findings. This is because the chosen population was among Universiti Malaysia Kelantan's students in City Campus with a total of 328 students from every course. In addition, the future research can be conducted using the students from other Malaysian Universities too. It would be great research if the target student is someone who has been diagnosed with a mental health issue and does an interview face to face that can provide more truthful information in this research.

## CONCLUSION

The results of the survey responses in the questionnaire were analysed using a variety of methods, such as descriptive and inferential analysis. The results from the preceding chapter and the information from the questionnaire were next assessed using the statistical programme SPSS. For this investigation, H1, H2, and H3 are all viable possibilities. We also provided limitations and suggestions for this study that we believe will be beneficial for future research. It is therefore believed that the information supplied in this study will be valuable for future research.



## REFERENCES

- Akter, M., Sadekin, M. N., & Patwary, A. K. (2020). An Empirical Study on Students' Satisfaction from Mawlana Bhashani Science & Technology University, Bangladesh. *Review of Economics and Development Studies*, 6(2), 363-379.
- Alom, S., Patwary, A. K., & Khan, M. M. H. (2019). Factors affecting the turnover intention of Bangladeshi migrants in the United Arab Emirates: An empirical study on the hotel industry. *International Journal of Innovation, Creativity and Change*, 8(3), 344-360.
- Fengmin, Z., Baijun, W., Jiangtao, B., Li, L., & Patwary, A. K. (2022). Investigating revisit intention of medical tourists in China through nutritional knowledge, perceived medical quality, and trust in the physiologist: A recommendation on health tourism policy measures. *Frontiers in Public Health*, 10, 893497.
- Hazbar, A. M. H., Alem Mohammed, A., & Karim, A. K. A. (2019). An Empirical Study of Factors Influencing hotel customers' online booking Intention. *مجلة العلوم التربوية و الدراسات الإنسانية*, 5(5), 1-17.
- Li, L., Ragavan, N. A., Patwary, A. K., & Baijun, W. (2022). Measuring patients' satisfaction toward health tourism in Malaysia through hospital environment, nutritional advice, and perceived value: A study on Chinese exchange students. *Frontiers in public health*, 10, 893439.
- Li, L., Wu, B., & Patwary, A. K. (2022). How marine tourism promote financial development in sustainable economy: new evidences from South Asia and implications to future tourism students. *Environmental Science and Pollution Research*, 29, 1155-1172.
- Li, L., Wu, B., & Patwary, A. K. (2022). The psychosocial factors affecting chinese Outbound Exchange and mobility students' academic performance during COVID-19. *Frontiers in psychology*, 13, 872516.
- Patwary, A. K., Roy, B., Hoque, R., & Khandakar, M. S. A. (2019). Process of developing a community based tourism and identifying its economic and social impacts: An Empirical study on Cox's Bazar, Bangladesh. *Pakistan Journal of Humanities and Social Sciences*, 7(1), 1-13.
- Sumethokula, P., Patwary, A. K., Srinuanpanc, B., Srinuanpand, C., Suwandee, P., Thammathikul, A., & Phanong, W. (2020). The potential of new tour repackaging for creative tourism among entrepreneurs in Nakhon Si Thammarat. *International Journal of Innovation, Creativity and Change*, 13(10), 1752-1771.
- Taherdoost, H. (2016). Validity and Reliability of the Research Instrument; How to Test the Validation of a Questionnaire/Survey in a Research. *SSRN Electronic Journal*, 5(3). <https://doi.org/10.2139/ssrn.3205040>
- Theunissen, M.-J., Jansen, M., & van Gestel, A. (2011). Are mental health and binge drinking associated in Dutch adolescents? Cross-sectional public health study. *BMC Research Notes*, 4(100). <https://doi.org/10.1186/1756-0500-4-100>.
- Wu, B., Liu, S., Wang, J., Tahir, S., & Patwary, A. K. (2021). Assessing the mechanism of energy efficiency and energy poverty alleviation based on environmental regulation policy measures. *Environmental Science and Pollution Research*, 28, 40858-40870.

- Wu, B., Zhai, B., Mu, H., Peng, X., Wang, C., & Patwary, A. K. (2021). Evaluating an economic application of renewable generated hydrogen: A way forward for green economic performance and policy measures. *Environmental Science and Pollution Research*, 1-15.
- Zivin, K., Eisenberg, D., Gollust, S. E., & Golberstein, E. (2009). Persistence of mental health problems and needs in a college student population. *Journal of Affective Disorders*, 117, 180–185. <https://doi.org/10.1016/j.jad.2009.01.001>.

# The Factor That Influence the Daily Diet among Wellness Student in Universiti Malaysia Kelantan, Kampus Kota

Fazlin Anita binti Ahmad, Nur Fatin binti Azranuddin, Nur Shayhira Binti Shamsuddin, Nur Umirah binti Saffian & \*Encik Mohd Hafzal bin Abdul Halim

*Faculty of Hospitality, Tourism and Wellness, Universiti Malaysia Kelantan*

*Corresponding email: [hafzal@umk.edu.my](mailto:hafzal@umk.edu.my)*

---

## ABSTRACT

*Daily diet is a way to reduce the obesity problem that is happening now. Those who practice a daily diet should take their food according to the correct portion. A balanced diet can be referred to through the food pyramid. For example, bread, meat, milk and so on. This study took about 2 months, from November 2022 until January 2023. This study was conducted to identify factors that influence daily diet among Wellness students at the Universiti Malaysia Kelantan, Kampus Kota. A pilot study conducted on Wellness students totaling 124 people as a respondent at Universiti Malaysia Kelantan, Kampus Kota. This data was collected through the distribution of survey forms which showed a good response rate. The results of this study were done to give awareness to students, especially Wellness students, about the factors that affect their daily nutrition. The results of this study can also be used as a reference to health centers or nutritionists.*

**Keywords:** Daily Diet, Individual Factors, Social Factors, Environment Factors

---

## INTRODUCTION

Studying at a higher level after finishing high school leads to changes for teenagers. Now, the personality attitude of a person's increasing workload causes students to be stressed and have to face various changes. In particular, migration occurs to families for those who study outside the area. With the occurrence of separation from the family, the students do not choose food to eat and eat whatever is served. This change occurs so that the attitude among teenagers who practice physical activity and food consumption in healthy eating habits can prevent obesity from occurring. Although, there are some habits that exist in a person that are associated with a person's attitude to face the possibility of change.

The body will receive the nutrients it needs to operate properly from a balanced diet (Krans, 2020). These young adults are at a critical juncture in their development and maintenance of numerous behaviours that affect their health. A study center that has a variety of newly learned patterns to replace the old or existing ones (Suliga, 2020).

Many factors, such as personal ones such as a unable to control himself or too busy), social ones such as peer pressure or parental oversight, local such as easy to find or application and cost to particular products, larger ones such as advertising, can have an impact on how university students eat (Velex-Toral et al., 2020). Social factors can also be related to university students such as living alone (Bárbara et al, 2020) gender, academic performance satisfaction (Whatnall et al., 2019), information adequacy (El Hajj et al., 2021) as well as anxiety and depression (Wattick et al., 2018).

There is a dietary pattern used which is the use of a type of primary Hepatocellular Carcinoma (HCC) and hepatitis B virus and hepatitis C virus infection. The eating pattern is reversed and based

on vegetables. It is also associated with a high Hepatocellular Carcinoma (HCC) which is 0.66, 95% CI 0.46 - 0.94) compared to tertiles. There are potential findings as to the role of diet to control HCC and clinical management.

There were three objective of this research:

1. To investigate the relationship between individual factors and daily diet among Wellness students in Universiti Malaysia Kelantan, Kampus Kota.
2. To investigate the relationship between social culture factors and daily diet among Wellness students in Universiti Malaysia Kelantan, Kampus Kota.
3. To investigate the relationship between environment factors and daily diet among Wellness students in Universiti Malaysia Kelantan, Kampus Kota.

## **SIGNIFICANT OF STUDY**

### **Help researchers.**

In the research, it helps the researchers to understand how to manage a diet properly. The researchers have found out the issues and reveal in more detail the influencing factors daily diet among Wellness students and to reduce the factor that influences the daily diet among Wellness students in Universiti Malaysia Kelantan Kampus Kota. Lecturers should play a role of providing information about the benefits of practicing a proper daily diet.

### **Help the Ministry of Health Malaysia.**

In addition, it can help the Ministry of Health Malaysia to provide exposure to students about the benefits of practicing a daily diet. With that, various methods that researchers will do to students, especially wellness students at Universiti Malaysia Kelantan at Kampus Kota, are to hold campaigns or lectures. Therefore, it will facilitate the work of the Ministry of Health Malaysia due to the existence of studies that provide benefits.

### **Help the Universiti Malaysia Kelantan Kampus Kota counseling unit.**

Some of the wellness students who want to practice the right daily diet will meet face to face to get suggestions or views from them. With that, the researcher will conduct an online interview with the wellness student to reveal details related to the daily diet. Therefore, the researcher can help the counseling to solve this problem.

### **Parent's responsibility.**

Parents should take responsibility in attracting children's interest in nutrition. Parents should set an example for their children so that they are more influenced by their parents' nutritional practices from birth to adulthood. Through this study, it is hoped that students will gain knowledge about healthy eating practices so that their health and personal development are perfect. This study also aims to make parents aware of the importance of good nutritional practices in their children's learning.

## **LITERATURE REVIEW**

### **Individual Factor**

Individual factors are the main cause of a student's eating habits. The attitude of students who are skilled in cooking either heavy or light food makes it difficult for students to practice a balanced diet. In addition, some students who have problems or have stress can also result in students taking excessive food without following the time (Kabir et al., 2018). Although adopting good lifestyle habits is important for people at all stages of life, youth is the most important time. Behavioral development in adulthood is important and can be linked to various chronic disease risks that are increasing.

Most teenagers like university students are good at making decisions in choosing food and also the preparation of eating interesting food causes them to feel challenged. The behavior and attitude of students vary according to where they live, student conditions and so on. and not only that, factors such as complete facilities, free time, social networks and social media that are becoming more and more prevalent with viral foods that cause students to be influenced. Therefore, responsible superiors such as administrators need to provide advice or information to students to reduce the problem of obesity. In addition, social media that displays healthy food preparation menus should be encouraged to increase discipline in students and be wise to control themselves and be wise to manage time properly. University life may encourage students to relax and overeat low-quality food (Ramón et al., 2021).

### **Social Culture Factor**

Food habits are impacted by socio-cultural background, religious beliefs and conventions, and personal preference in general. However, there may be some more reasons for teenagers and youth to embrace fast food culture. As a result, the current investigation was done with the aims in mind. To investigate the eating patterns of teenagers and young people in relation to fast food intake. To investigate the sociocultural, demographic, and other features of fast food customers. To evaluate the nutritional characteristics of fast food consumers (Lolokote, 2017).

Food selection is a process where students think, taste, and eat the food before buying it. Therefore, there are various negative effects on their health and well-being even up to the global level. The purpose of this qualitative investigation is to study the opinions of the residents of Tehran and their life experiences related to the psychological, social and cultural variables of food choices (Haghighian, 2017).

Sociocultural variables, which include ethnicity and religion such as age, gender, and education are mediated by individuals' attitudes and beliefs, contribute to food selection and eating practises, influencing purchasing behaviours. There are several studies on variables related to food choices that have shown the main effect of socio-cultural determinants in choosing various cuisines around the world. (Islam, 2019).

### **Environment Culture**

Existing environmental elements have influenced students' daily diets, particularly food selection, food pricing, and the conditions of establishments that sell food, as well as transportation gaps. Climate change disrupts food supplies, raises food prices, and ultimately limits some people' access to nutrient-dense and nutritious meals (Willett, 2019).

Furthermore, the location of a restaurant or cafe is important to students. The lack of access to transportation also has an impact on students' daily nutrition. This is because if the restaurant is a long distance away, they may hire Grabcar, which has a hefty delivery cost. Most students will be hesitant and lethargic to travel to locations that are too far away (Irwan, 2017). Kiara (2017) deduced

from the present phenomenon how adaptable or diverse today's youth's food preferences are. As a result, a restaurant or cafe must grasp the desires or expectations of visiting consumers in order for restaurants or cafes that target youth to match the demand of the target market.

Students frequently claimed that food cost was a major factor in deciding their dietary intake (Sogari, 2018). Most students skipped breakfast in favor of lunch to save money (Fazal, 2019). Pocket money is only provided in small amounts by families because the majority of students in public colleges are from the lower middle socioeconomic class in order to help them get on with their lives. Thus, their expenses are reduced so that not having breakfast is a strategy to continue survival (Kabir et al., 2018).

### Daily diet

Changes in daily diet in environmental factors have an unfavorable impact on diet quality and eating habits, which can raise rates of overweight and obesity as well as metabolic risk factors in people of all ages (Hwalla et al., 2017). Intervention from psychology to support a healthy diet is part of the definition of that diet which reduces the problem of obesity as well as chronic diseases (De Ridder et al., 2017). Operationally, several factors that affect a person's daily diet, namely individual factors, social factors or environmental factors that are measured by Food Frequency Questionnaire (FFQ).

### Research Hypotheses

**Hypothesis 1:** There is a significant relationship between individual factors and daily diet among Wellness students in Universiti Malaysia Kelantan.

**Hypothesis 2:** There is a significant relationship between social culture factors and daily diet among Wellness students in Universiti Malaysia Kelantan.

**Hypothesis 3:** There is a significant relationship between environment factors and daily diet among Wellness students in Universiti Malaysia Kelantan.

### Research Framework

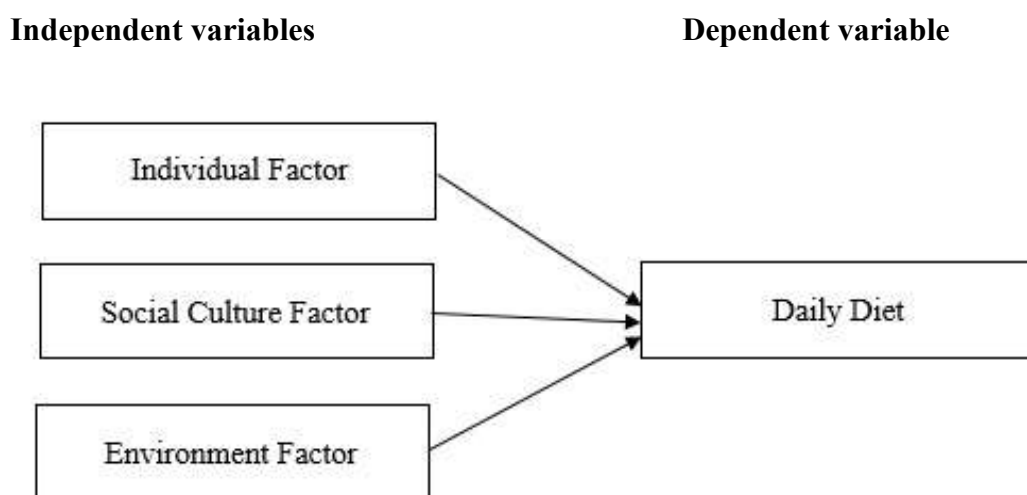

Figure 1: Conceptual Framework

The conceptual framework that has independent variables and dependent variables. In the conceptual framework, independent variables which are individual factors, socio-cultural factors and environmental factors are influenced by dependent variables which are daily diet.

## **METHODOLOGY**

### **Research Design**

The research design serves the purpose of ensuring that the data collected allows researchers to effectively address the current challenges of the study. In this research, quantitative methods are being used as the primary tool for gathering data from the respondents. This approach takes advantage of the numerical data collected through the survey. The information obtained will assist the analyst in understanding the relationship between independent and dependent variables within the framework of this investigation. The research is categorized as descriptive research, and a questionnaire will be utilized to gather data from a total of 248 respondents who are Wellness students from the Faculty of Hospitality, Tourism, and Wellness at Universiti Malaysia Kelantan, Kampus Kota.

### **Data Collection**

Data collection is the process of collecting, measuring and interpreting accurate research-related information using accepted, established methods. A survey which is Google Form is used as the main research instrument. The questionnaire was administered online, allowing respondents to respond quickly. It will give convenience to the respondents and bring them to answer the questionnaire without any strain and also be suitable to give honest and accurate information. The researchers choose Google form because it makes it easier to distribute the questionnaire more quickly when the researcher shares the Google form link with the questions on it to the respondents. A total of 248 respondents were given the same set of questionnaires to obtain information about dietary practices and their responses to matters related to nutrition. The demographic profile, dependent variable, and three independent variables are included in the three sections of the questionnaire. This questionnaire is distributed specifically to Wellness students in University Malaysia Kelantan, Kampus Kota.

In addition, this questionnaire contains a nominal scale which is for Part A which focuses on the demographic profile of the respondents. This research used a Likert scale for Part B which is the dependent variable, and Part C consists of three independent variables for this study. The questionnaire is divided into three different parts. In section A, the questions are about respondents' racial and gender identity, as well as their age, education level, religion and marital status. In section B, the dependent variable which is the daily diet question. In section C, there are 3 factors in this part. The first independent variable, which is an individual factor, is shown in section C (i). The social cultural factor, the second independent variable in the questionnaire section C (ii). The third independent factor, the environment factor, is presented in section C (iii). The questionnaire consists of several items scored on Likert scale like 1 for strongly disagree, 2 for disagree, 3 for not at all, 4 for agree and 5 for strongly agree.

### **Sampling**

This study used convenience sampling for this study. A non-high probability sampling method called convenience sampling involves choosing the units that be a part of the sample. This is said to

be so because it is the easiest method for researchers to do which can also be due to geographical location, availability at a certain time and so on. This sampling is convincing and makes it easier for researchers to get respondents. The selected respondents are Wellness students at Universiti Malaysia Kelantan at the Kampus Kota which has 700 people as respondents. In addition, the researcher chose well-being students because they are more vulnerable in relation to health and also have in-depth knowledge about health compared to other people.

## Data Analysis

Data analysis is the process of collecting and analyzing data to find out what it means. It is also the technique used by researchers to break down and interpret data to derive insights, offer suggestions, and support decision making. The information collected by the researchers was processed and used in the study. There are various sources that have been used to gather all the data. SPSS or also known as The Statistical Package for Social Science will be used to analyse the data that researchers collect in this study. Therefore, researchers from a variety of fields utilise the IBM SPSS Version 25 software for quantitative analysis of complex data. These statistical tools can be used in processing statistical data and it also can be used to provide the answer for the purpose of this study.

Descriptive analysis also known as descriptive statistics. Data are attempted to be explained or summarised with descriptive analysis. It makes data utilisation simpler, which can facilitate action by analysts and aid in the weeding out of useless data. Frequency, central tendency, dispersion or variation, and position are the four components of descriptive analysis. Depending on what researchers are trying to find, descriptive analysis can be done in a variety of ways, but often entails gathering, cleaning, and then analysing data.

This researcher also used reliability analysis to determine how well a measuring approach to gather data for this study. A study's measurement process has to be trustworthy before the findings can be regarded as valid. Consistency, or the extent to which survey questions are asking respondents the same kinds of questions repeatedly, is what reliability is all about. In this study, the reliability scale and internal consistency are measured using Cronbach's Alpha.

Not only that, researchers also used Pearson's correlation coefficient to determine the relationship between two continuous variables. This statistic uses the concept of covariance, which is recognized as the best technique for studying the relationship between variables. It shows how many links exist between two variables, as well as the direction of the relationship. It is used to assess the strength of a link between two numerical variables (at least interval scale). Correlation strength can be determined within positive (+) and negative (-).

## FINDINGS

### Demographic Analysis

Table 1: Demographic Analysis

CHARACTERISTIC	FREQUENCY (n)	PERCENTAGE (%)
<b>1. Gender</b>		
Male	61	24.6
Female	187	75.4



<b>2. Age</b>		
18-21 years	26	10.48
22-25 years	207	83.47
26-29 years	15	6.05
<hr/>		
<b>3. Marital Status</b>		
Single	227	91.53
Married	21	8.47
<hr/>		
<b>4. Race</b>		
Malay	221	89.11
Chinese	12	4.84
Indian	12	4.84
Other	3	1.21
<hr/>		
<b>5. Religion</b>		
Muslim	222	89.52
Buddha	20	8.06
Christian	5	2.02
Other	1	0.20
<hr/>		
<b>6. Educational Level</b>		
Degree	240	96.77
Diploma	8	3.23
<hr/>		

Table above shows the result of frequency and percentage analysis of respondents. The research focuses on Wellness students in Universiti Malaysia Kelantan, Kampus Kota. Respondents in this study consisted of Wellness students Year 1 to Year 4. A total of 187 female respondents (75.40%) and 61 male respondents (26.60%) participated in the study that focuses on Wellness students. Based on the age of respondents that were shown 26 respondents (10.48%) between 18-21 years old, 207 respondents of 22-25 years old (83.47%) and 15 respondents (6.05%) of 26-29 years old. When it comes to respondents' marital status, the majority of the respondents are single 227 (91.53%) and 21 (8.47%) of the respondents are married. For the respondent's background of races, the total of Malay are 221 (89.11%). The total of Chinese and Indian are 12 (4.84%) and the other races, Iban, are 3 of the respondents (1.21%). Based on the analysis of the religion, the total of the Muslim respondents are 222 (89.52%), 20 respondents (8.06%) of Buddha, 5 respondents of Christian (2.02%) and the other religion of respondents are Hindu only 1 (0.40%). Lastly, the respondents of educational level. The level of Degree is 240 (96.77%) and the Diploma is 8 of respondents (3.23%).

## Descriptive Analysis

Table 2: Descriptive Analysis

Variable	Items	Mean Score	Standard Deviation
Daily Diet	I have a lack of nutrition knowledge.	3.40	1.331
	I skip meals.	3.34	1.322
	I eat too much food late at night.	3.30	1.371
	There is a lack of healthy food options on campus.	3.69	1.192
	I eat too much junk food.	3.44	1.245
	I have no time to eat healthy.	3.13	1.320
	I usually choose my favourite food rather than nutritious one.	3.59	1.247
	I will try to take the food for health, even though it is not familiar with me.	3.66	1.176
	I think that I do not need to change as far as I am satisfied with present diet.	3.46	1.216
	I enjoy the food that are known to be good for health.	3.83	1.105
Individual Factor	I practice a low-salt diet.	3.94	1.024
	I like to eat vegetables.	4.04	1.037
	I often exercise in the evening	3.64	1.186
	I don't eat fast food.	3.73	1.139
	I make fruits as my side food.	4.06	0.861
	I always carry out health checks.	3.64	1.141
	I always take supplements.	3.81	1.124
	I always practice a healthy lifestyle.	3.97	0.899
	I always eat foods that are high in sugar.	3.56	1.242
	I often drink carbonated drinks.	3.28	1.397
Social Culture Factor	I usually eat food that is trendy.	3.77	1.173
	I eat certain foods because other people such as family, friends also eat it.	3.87	0.962

	Eating the way I do gives me a sense of satisfaction.	3.99	0.992
	I like to try new foods which I am not accustomed eat.	3.79	1.090
	I choose the foods I eat because it fits the reason.	4.13	0.900
	It is important to me that the food I eat is similar to the food I ate when I was a child.	3.69	1.055
	I eat certain foods because I am expected to eat them.	3.74	1.080
	My eating habits are superior to others.	3.61	1.147
	Unhealthy eating is a source of stress in relationships with people.	3.89	1.047
	I will think about healthy food when engaging in activities with the Malaysian Ministry of Health together with the local community on how to manage a healthy diet.	4.07	0.960
Environment Factor	When I cook, I have in mind the quantities to avoid food waste.	4.73	0.819
	My schedule is overloaded. I look for food I can quickly buy, make and swallow.	4.01	0.856
	It is important to me that the food I eat is prepared/packed in an environmental friendly way.	4.10	0.898
	It is important to me that the food I eat comes from my own country.	3.95	0.968
	I do not care about the country of origin when I consume or buy the food.	3.71	1.137
	I choose food that have been produced in countries where human right are not violated.	4.17	0.837
	I prefer to eat food that has been produced in a way that animal's rights have been respected.	4.13	0.888
	I choose the food that has certification from the government.	4.33	0.776
	I more prefer food that can be bought in shops close to where I live.	4.02	0.918
	I usually cook my own food.	4.18	0.825

The table above shows that the daily diet respondent 10 (I enjoy food known to be good for health) had the highest mean score which is (M = 3.83, SD = 1.105). Meanwhile, respondent daily diet item 6 (I don't have time to eat healthy) had the lowest mean score which is (M = 3.13, SD = 1.320). For individual factor 5 (I make fruits as my side food) had the highest mean score which is (M = 4.06, SD = 0.861). Whereas, respondent individual factor 10 (I often drink carbonated drinks) had the lowest mean score which is (M = 3.28, SD = 1.397). The results reveal that the respondent for social culture factor 5 (I choose the food I eat because it fits the reason) had the highest mean score which is (M = 4.13, SD = 0.900). While respondents of social culture factor 8 (My eating habits are higher than others) had the lowest mean score which is (M = 3.61, SD = 1.147).

## Reliability Analysis

Table 3: Reliability Analysis

Variable	Number of Items	Cronbach's Alpha
Daily Diet	10	0.925
Individual Factors	10	0.903
Social Culture Factors	10	0.906
Environment Factors	10	0.857

Table 3 shows the reliability dependent variable of daily diet is the highest value which is 0.925. For the independent variable of individual factors with 10 questions is 0.903 the Cronbach's Alpha value. The second independent variable is social factors and the value is 0.906 with 10 questions. The third of the independent variables is environmental factors and the value is 0.857 with 10 questions.

## Pearson Correlation Analysis

Table 4: Pearson Correlation Analysis

Pearson Correlation				
	Daily Diet	Individual Factors	Social Culture Factors	Environment Factors

<b>Daily Diet</b>	Pearson Correlation	1	.004	.218**	-.034
	Sig. (2-tailed)		.950	.001	.599
	N	248	248	248	248
<hr/>					
<b>Individual Factor</b>	Pearson Correlation	.004	1	.518**	.517**
	Sig. (2-tailed)	.950		.000	.000
	N	248	248	248	248
<hr/>					
<b>Social Culture Factor</b>	Pearson Correlation	.218**	.518**	1	.646**
	Sig. (2-tailed)	.001	.000		.000
	N	248	248	248	248
<hr/>					
<b>Environment Factor</b>	Pearson Correlation	-.034	.517**	.646**	1
	Sig. (2-tailed)	.599	.000	.000	
	N	248	248	248	248

## **HYPOTHESIS 1: DAILY DIET AND INDIVIDUAL FACTOR**

H1: There is a relationship between daily diet and individual factor.

The significant value for each individual factor is over 0.05 based on the results, while the p value is below 0.05. The alternative hypothesis is disproved and the null hypothesis is accepted. It reveals that there is no causal connection between individual factor and daily diet among Wellness students at Kampus Kota, Universiti Malaysia Kelantan. The individual factor and daily diet only have a very weak link, as seen by the Pearson correlation value of 0.004 for this relationship. H1 was therefore rejected.

## **HYPOTHESIS 2: DAILY DIET AND SOCIAL CULTURE FACTOR**

H2: There is a relationship between daily diet and social culture factor.

For p-value is greater than 0.05, whereas the social culture factor' significant value is less than 0.05. The alternative hypothesis is also accepted, despite the null hypothesis being rejected. The daily diet of Wellness students at Universiti Malaysia Kelantan, Kampus Kota, is significantly influenced by social cultural aspects. A weak link exists between social culture and daily diet as shown by the Pearson correlation value of 0.218. H2 was therefore accepted.

## **HYPOTHESIS 3: DAILY DIET AND ENVIRONMENT FACTOR.**

H3: There is a relationship between daily diet and environment factor.

The results show the significant level of the the p-value is lower than 0.05, and values for each individual factor are more than 0.05. The alternative hypothesis is disproved and the null hypothesis is accepted. This table demonstrates that no significant between environmental factors and daily diet. It proved that is no correlation between environmental influences and daily diet, according to the Pearson correlation coefficient of -0.034. H3 was therefore rejected.

## **DISCUSSION AND RECOMMENDATION**

The purpose of discussion is to explain the relationship between daily diet, individuals, social culture factors, and environment factors among Wellness students at the Universiti Malaysia Kelantan, Kampus Kota. Data analysis shows a significant relationship between daily diet and social and cultural characteristics. There is no correlative validation between individuals and environments of daily diet. But previous studies have shown a relationship between daily diet and individual, social culture and environmental variables. Next, Pearson correlation values show the individual factors which are very weak and environment factors have no correlation ( $0.218 > 0.004 > -0.034$ ).

## **RECOMMENDATION**

There are many recommendations for the next research. The first suggestion is that in order to get the best results, the target audience should be expanded to include Fakulti Keusahawanan dan Perniagaan (FKP). This is due to the fact that the students should be better knowledgeable about diet, nutrition, and contemporary nutritional issues that may be relevant to their research. In order to get better outcomes from their future studies, it can also be helpful. The researcher can utilize a variety of survey methods to respond to the questionnaire, which is the second piece of advice. To receive the quickest answer from the respondents, for instance, the researcher can employ a telephone survey or a personal interview that takes place face to face. The respondents will find it simple to ask the specified questions during personal interviews and telephone surveys, and both methods also allow for the provision of additional explanation if necessary. Additionally, it can broaden respondents' understanding and make them aware of the need for a healthy diet. The results will be more precise and useful if several survey methodologies are used. Finally, the questionnaire can be created in multiple languages, such as Mandarin and Tamil. Only English and Malay were used as the languages for the majority of the questionnaire. The respondents from different races can utilize their own languages to comprehend the questionnaire effectively and to make it easier for them to respond. As a result, the outcome will be more dependable and efficient.

## **CONCLUSION**

In conclusion, this study examines the variables affecting daily eating among Wellness students at Kampus Kota, Universiti Malaysia Kelantan. Independent variables are created from personal, social, cultural, and environmental aspects. The daily diet is the dependent variable that is impacted by this variable. The association between the dependent variable and the three independent variables is one significant and two not significant. According to the results of recapitulation, the social component is the weakest, followed by a very weak individual factor and uncorrelated environmental elements ( $0.218 > 0.004 > -0.034$ ). Additionally, it demonstrates that the three independent variables' p values are 0.950 for the individual factor, 0.001 for the social culture element, and 0.599 for the environment factor. The results are stronger and more reliable thanks to the numerous study publications in this part. In this study, H2 was accepted whereas H1 and H3 were denied. It was discovered that Wellness students at Universiti Malaysia Kelantan Kampus Kota had difficulty comprehending the surveys and showing interest in them. The target audience should be

expanded, additional survey methods should be used and more languages should be used. According to the research proposal, this will produce a very valuable study that will be very helpful in the future.

## REFERENCES

- Aceijas, C., Waldhäusl, S., Lambert, N., Cassar, S., & Bello-Corassa, R. (2017). Determinants of health-related lifestyles among university students. *Perspectives in public health*, 137(4), 227-236
- Ahmad, N. S. S., Sulaiman, N., & Sabri, M. F. (2022). Psychosocial Factors as Mediator to Food Security Status and Academic Performance among University Students. *International journal of environmental research and public health*, 19(9), 5535.
- Akter, M., Sadekin, M. N., & Patwary, A. K. (2020). An Empirical Study on Students' Satisfaction from Mawlana Bhashani Science & Technology University, Bangladesh. *Review of Economics and Development Studies*, 6(2), 363-379.
- Alom, S., Patwary, A. K., & Khan, M. M. H. (2019). Factors affecting the turnover intention of Bangladeshi migrants in the United Arab Emirates: An empirical study on the hotel industry. *International Journal of Innovation, Creativity and Change*, 8(3), 344-360.
- Antonopoulou, M., Mantzorou, M., Serdari, A., Bonotis, K., Vasios, G., Pavlidou, E., Trifonos, C., Vadikolias, K., Petridis, D., & Giaginis, C. (2020). Evaluating Mediterranean diet adherence in university student populations: Does this dietary pattern affect students' academic performance and mental health?. *The International journal of health planning and management*, 35(1), 5–21.
- Bakdash, J. Z., & Marusich, L. R. (2017). Repeated measures correlation. *Frontiers in psychology*, 8, 456.
- Błaszczyk-Bębenek, E., Piórecka, B., Płonka, M., Chmiel, I., Jagielski, P., Tuleja, K., & Schlegel-Zawadzka, M. (2019). Risk factors and prevalence of abdominal obesity among upper-secondary students. *International Journal of Environmental Research and Public Health*, 16(10), 1750.
- Boukrim, M., Obtel, M., Lahlou, L., & Razine, R. (2021). University students' perceptions and factors contributing to obesity and overweight in Southern of Morocco. *African health sciences*, 21(2), 942–950.
- Buyuktuncer, Z., Ayaz, A., Dedebayraktar, D., Inan-Eroglu, E., Ellahi, B., & Besler, H. T. (2018). Promoting a healthy diet in young adults: the role of nutrition labelling. *Nutrients*, 10(10), 1335.
- Cena, H., & Calder, P. C. (2020). Defining a Healthy Diet: Evidence for The Role of Contemporary Dietary Patterns in Health and Disease. *Nutrients*, 12(2), 334.
- Chen, C., Chaudhary, A., & Mathys, A. (2019). Dietary Change Scenarios and Implications for Environmental, Nutrition, Human Health and Economic Dimensions of Food Sustainability. *Nutrients*, 11(4), 856.
- Cockerham, W. C. (2021). *The Social Causes of Health and Disease*. In *Google Books*. John Wiley & Sons.
- De Ridder, D., Kroese, F., Evers, C., Adriaanse, M., & Gillebaart, M. (2017). Healthy diet: Health impact, prevalence, correlates, and interventions. *Psychology & health*, 32(8), 907-941.
- Fazal, R., & Kazimi, A. B. (2019). Dietary Behavior Of University Going Female Adolescents In Pakistan: Issues, Challenges And Strategies For General Health And Academic Performance. *Pakistan Journal of Gender Studies*, 18(1), 97-112.
- Feng, Y., You, H., Zhang, Z., Ji, R., & Gao, Y. (2019). Hypergraph neural networks. In *Proceedings of the AAAI conference on artificial intelligence* 33(1), 3558-3565.

- Fengmin, Z., Baijun, W., Jiangtao, B., Li, L., & Patwary, A. K. (2022). Investigating revisit intention of medical tourists in China through nutritional knowledge, perceived medical quality, and trust in the physiologist: A recommendation on health tourism policy measures. *Frontiers in Public Health*, 10, 893497.
- Fonseca, X., Lukosch, S., & Brazier, F. (2018). Social cohesion revisited: a new definition and how to characterise it. *Innovation: The European Journal of Social Science Research*, 32(2), 1–23.
- García Rodríguez, M., Romero Saldaña, M., Alcaide Leyva, J. M., Moreno Rojas, R., & Molina Recio, G. (2019). Design and validation of a food frequency questionnaire (FFQ) for the nutritional evaluation of food intake in the Peruvian Amazon. *Journal of Health, Population and Nutrition*, 38(1).
- Haghighian Roudsari, A., Vedadhir, A., Amiri, P., Kalantari, N., Omidvar, N., Eini-Zinab, H., & Hani Sadati, S. M. (2017). Psycho-Socio-Cultural Determinants of Food Choice: A Qualitative Study on Adults in Social and Cultural Context of Iran. *Iranian journal of psychiatry*, 12(4), 241–250.
- Harrison, S., Couture, P., & Lamarche, B. (2020). Diet Quality, Saturated Fat and Metabolic Syndrome. *Nutrients*, 12(11), 3232.
- Hashim, M. S., Obaideen, A. A., Jahrami, H. A., Radwan, H., Hamad, H. J., Owais, A. A., Alardah, L. G., Qiblawi, S., Al-Yateem, N., & Faris, M. A. E. (2019). Premenstrual Syndrome Is Associated with Dietary and Lifestyle Behaviors among University Students: A Cross-Sectional Study from Sharjah, UAE. *Nutrients*, 11(8), 1939.
- Hazbar, A. M. H., Alem Mohammed, A., & Karim, A. K. A. (2019). An Empirical Study of Factors Influencing hotel customers' online booking Intention. *مجلة العلوم التربوية و الدراسات الإنسانية*, (5), 1-17.
- Higgs, S., & Ruddock, H. (2020). Social influences on eating. *Handbook of eating and drinking: Interdisciplinary perspectives*, 277-291.
- Huang, C. L., Yang, S. C., & Chiang, C. H. (2020) The Associations between Individual Factors, eHealth Literacy, and Health Behaviors among College Students. *International Journal of Environmental and Public Health*, 17(6) 2108.
- Hwalla, N., Al Dhaheri, A. S., Radwan, H., Alfawaz, H. A., Fouda, M. A., Al-Daghri, N. M., & Blumberg, J. B. (2017). The prevalence of micronutrient deficiencies and inadequacies in the Middle East and approaches to interventions. *Nutrients*, 9(3), 229.
- Kabir, A., Miah, S., & Islam, A. (2018). Factors influencing eating behaviour and dietary intake among resident students in a public university in Bangladesh: A qualitative study. *PloS one*, 13(6).
- Karunanayake, D., Jayasooriya, M. W. D. S. M., & Vimukthi, N. D. U. (2020) Psychological Impact on the Eating Behaviours of University Students. *South Asian Journal of Social Studies and Economics*, 8(4), 132-141
- Kobayashi, E., Sato, Y., Umegaki, K., & Chiba, T. (2017). The prevalence of dietary supplement use among college students: A nationwide survey in Japan. *Nutrients*, 9(11), 1250.
- Li, L., Ragavan, N. A., Patwary, A. K., & Baijun, W. (2022). Measuring patients' satisfaction toward health tourism in Malaysia through hospital environment, nutritional advice, and perceived value: A study on Chinese exchange students. *Frontiers in public health*, 10, 893439.
- Li, L., Wu, B., & Patwary, A. K. (2022). How marine tourism promote financial development in sustainable economy: new evidences from South Asia and implications to future tourism students. *Environmental Science and Pollution Research*, 29, 1155-1172.



- Li, L., Wu, B., & Patwary, A. K. (2022). The psychosocial factors affecting chinese Outbound Exchange and mobility students' academic performance during COVID-19. *Frontiers in psychology*, 13, 872516.
- Lolokote, S., Hidru, T. H., & Li, X. (2017). Do socio-cultural factors influence college students' self-rated health status and health-promoting lifestyles? A cross-sectional multicenter study in Dalian, China. *BMC public health*, 17(1), 478.
- López-Gil, J. F., & Tárraga-López, P. J. (2022). Research on Diet and Human Health. *International journal of environmental research and public health*, 19(11),
- Luo, Y. F., Yang, S. C., Chiang, C. H., & Lu, C. M. (2018). Development and validation of a food literacy self-report inventory and investigation of the relationships between food literacy and dietary behaviour among college students. *Taiwan J. Public Health*, 37, 407-419.
- Melini, V., & Melini, F. (2019). Gluten-Free Diet: Gaps and Needs for a Healthier Diet. *Nutrients*, 11(1), 170.
- Mitchell, S. J., Bernier, M., Mattison, J. A., Aon, M. A., Kaiser, T. A., Anson, R. M., Ikeno, Y., Anderson, R. M., Ingram, D. K., & de Cabo, R. (2019). Daily Fasting Improves Health and Survival in Male Mice Independent of Diet Composition and Calories. *Cell Metabolism*, 29(1), 221-228.
- Moussa, I., Day, R. S., Li, R., Du, X. L., Kaseb, A. O., Jalal, P. K., Daniel-MacDougall, C., et al. (2021). Dietary Patterns and Hepatocellular Carcinoma Risk among US Adults. *Nutrients*, 13(6), 2011.
- Murphy, N., Moreno, V., Hughes, D. J., Vodicka, L., Vodicka, P., Aglago, E. K., Gunter, M. J., & Jenab, M. (2019). Lifestyle and dietary environmental factors in colorectal cancer susceptibility. *Molecular aspects of medicine*, 69, 2–9.
- Nankabirwa, R. (2017). Factors Affecting Dietary Patterns Among Students At International Health Sciences University. *Doctoral dissertation, International Health Sciences University*.
- Olatona, F.A., Onabanjo, O.O., Ugbaja, R.N. et al. (2018). Dietary habits and metabolic risk factors for non-communicable diseases in a university undergraduate population. *J Health Popul Nutr* 37, 21.
- Patwary, A. K., Roy, B., Hoque, R., & Khandakar, M. S. A. (2019). Process of developing a community based tourism and identifying its economic and social impacts: An Empirical study on Cox's Bazar, Bangladesh. *Pakistan Journal of Humanities and Social Sciences*, 7(1), 1-13.
- Ramón-Arbués, E., Granada-López, J.-M., Martínez-Abadía, B., Echániz-Serrano, E., Antón-Solanas, I., & Jerue, B. A. (2021). Factors Related to Diet Quality: A Cross-Sectional Study of 1055 University Students. *Nutrients*, 13(10), 3512.
- Rodrigues, P. R. M., Luiz, R. R., Monteiro, L. S., Ferreira, M. G., Gonçalves-Silva, R. M. V., & Pereira, R. A. (2017). Adolescents' unhealthy eating habits are associated with meal skipping. *Nutrition*, 42, 114-120.
- Saghafi-Asl, M., Aliasgharzadeh, S., & Asghari-Jafarabadi, M. (2020) Factors influencing weight anagement behavior among college students: An application of the Health Belief Model. *PLOS ONE*, 16(5): c0252258
- Sayuti, Y.A., Albattat, A., Nazrin, N. S., & Silahudeen, T.N.A.T. (2020) Food safety knowledge, attitude and practices among management and science university students, Shah Alam. *Management Science Letters*, 10(4), 929-936.
- Schuh, M., & Bush, M. L. (2021). Defining Disparities in Cochlear Implantation through the Social Determinants of Health. *Seminars in Hearing*, 42(04), 321–330.
- Sievert, K., Lawrence, M., Naika, A., & Baker, P. (2019). Processed foods and nutrition transition in the Pacific: Regional trends, patterns and food system drivers. *Nutrients*, 11(6), 1328.
- Sogari, G., Velez-Argumedo, C., Gómez, M., & Mora, C. (2018). College Students and Eating Habits: A Study Using An Ecological Model for Healthy Behavior. *Nutrients*, 10(12), 1823.

- Stok F.M., Renner B., Clarys P., Deliens T.(2018). Understanding Eating Behavior during the Transition from Adolescence to Young Adulthood: A Literature. *Nutrients.*;10:667.
- Sugiharni, G. A. D., Setiasih, N. W., Mahendra, I., Ardana, I., & Divayana, D. G. H. (2018). Development of alkin model instruments as evaluation tools of blended learning implementation in discrete mathematics course on STIKOM Bali. *Journal of Theoretical and Applied Information Technology*, 96(17), 5803-5818.
- Sumethokula, P., Patwary, A. K., Srinuanpanc, B., Srinuanpand, C., Suwandeee, P., Thammathikulf, A., & Phanong, W. (2020). The potential of new tour repackaging for creative tourism among entrepreneurs in Nakhon Si Thammarat. *International Journal of Innovation, Creativity and Change*, 13(10), 1752-1771.
- Trigueros, R., Padilla, A. M., Aguilar-Parra, J. M., Rocamora, P., Morales-Gázquez, M. J., & López-Liria, R. (2020). The Influence of Emotional Intelligence on Resilience, Test Anxiety, Academic Stress and the Mediterranean Diet. A Study with University Students. *International Journal of Environmental Research and Public Health*, 17(6), 2071.
- Vélez-Toral, M.; Rodríguez-Reinado, C.; Ramallo-Espinosa, A.; Andrés-Villas, M. (2020). “It’s Important but, on What Level?”: Healthy Cooking Meanings and Barriers to Healthy Eating among University Students. *Nutrients*, 12, 2309.
- Willett, W., Rockström, J., Loken, B., Springmann, M., Lang, T., Vermeulen, S., & Murray, C. J. (2019). Food in the Anthropocene: the EAT–Lancet Commission on healthy diets from sustainable food systems. *The Lancet*, 393(10170), 447-492.
- Wu, B., Liu, S., Wang, J., Tahir, S., & Patwary, A. K. (2021). Assessing the mechanism of energy efficiency and energy poverty alleviation based on environmental regulation policy measures. *Environmental Science and Pollution Research*, 28, 40858-40870.
- Wu, B., Zhai, B., Mu, H., Peng, X., Wang, C., & Patwary, A. K. (2021). Evaluating an economic application of renewable generated hydrogen: A way forward for green economic performance and policy measures. *Environmental Science and Pollution Research*, 1-15.
- Yan, Z., & Harrington, A. (2019) Factors that predict weight gain among first-year college students. *Health Education Journal*, 17(10) 94-103
- Zhi-Meng Lim, Qiu-Ting Chie, Lai-Kuan Teh (2020), Influence of dopamine receptor gene on eating behaviour and obesity in Malaysia, *Meta Gene*, 25

# Weight Management of Obesity Among Student In Universiti Malaysia Kelantan

Mazfiqqa Binti Ramli, Nor Adzim Hafifi Bin Jainuddin, Siti Nur Athirah Binti Nazari, Zaidatul Afiqah Binti Zamri & \* Mohd Hafzal Bin Abdul Halim

Faculty of Hospitality, Tourism and Wellness, Universiti Malaysia Kelantan Corresponding email:

[hafzal@umk.edu.my](mailto:hafzal@umk.edu.my)

## ABSTRACT

*Obesity has been one of the issues that keeps growing concern in Malaysia. This research with the highest prevalent of obesity in Malaysia, the researcher wishes to look at how students at Universiti Malaysia Kelantan (UMK) may manage their weight through exercise. The research objectives of this study are to investigate the relationship between unhealthy lifestyle, environment factors and control over behaviour on obesity in Universiti Malaysia Kelantan (UMK). The study was conducted using a quantitative research approach which is through online questionnaire to collect the data. There were 120 respondents participated in this study. The study proven that there is significant relationship between unhealthy lifestyle, environment, control over behaviour and obesity among students in Universiti Malaysia Kelantan (UMK). Throughout the whole research, there are a few attentions and discussion about the limitation should be emphasized in this study. The implication of this study were lacking of current studies on related subject and there were some respondents who did not give full cooperation in the data collection process which makes it difficult for the researcher to continue the study in a short period of time.*

**Keywords: Obesity, Unhealthy Lifestyle, Environment, Control Over Behaviour**

## INTRODUCTION

Obesity has been one of the issues that keeps growing concern in Malaysia. 17.4% of respondents report eating fast food at least once a week. But the majority of them claimed to eat fast food at least once a month. Moreover, it was shown that younger age groups, Malay people, and childless people were more significantly likely to consume fast food weekly. Compared to other ethnic groups, Malay people eat fast food more frequently. Most of the participants were overweight. Only 13.8% of obese people said they ate fast food weekly, and only 50.8% said they did so monthly. There is little correlation between fast food consumption frequency and obesity. Fast food eating on a regular basis is really concerning. Increased usage is significantly influenced by accessibility (Abdullah et al.,2017).

Other findings showed that It is important to prevent obesity and all students should strengthen positive behavioral habits, increase awareness, and promote workable prevention methods. For preventing overweight and obesity is to raise public awareness. Strong school- based policies,

successful curricula, and knowledgeable mentors in spreading healthy eating and physical activity programmes in schools. Similar significance was noted in recent studies, which claimed that school-based intervention strategies led to behavioral change in terms of an increase in dietary intake of nutritious foods and a decrease in consumption of unhealthy foods among the younger generation (Tong et al., 2022). Therefore, the main focus of this study is to find out Weight Management Of Obesity Among Student In Universiti Malaysia Kelantan (UMK).

There were three objectives of this research:

1. To investigate the relationship between unhealthy lifestyle and obesity of students in Universiti Malaysia Kelantan (UMK).
2. To investigate the relationship between environment factors and obesity of students in Universiti Malaysia Kelantan (UMK).
3. To investigate the relationship between the control over behavior and obesity students in Universiti Malaysia Kelantan (UMK).

## **SIGNIFICANCE OF THE STUDY**

### ***University Students***

This study is made available to students at all institutions so they may conduct a detailed analysis of obesity weight management and learn how to regulate their behaviour while consuming foods that might contribute to obesity. The advantages of this study might encourage obese persons to maintain a healthy diet and weight. Improvements in risk variables that can be brought about by nutrition, exercise, and behavior management can be included.

### ***Pusat Kesihatan Universiti (PKU)***

The significance of the study conduct by this research is expected to make it a guideline to get sort of data about students who are in obesity class. By data and targeted students, Pusat Kesihatan Universiti (PKU) can create a medical check-up event to be aware of obesity in students. This event can create health awareness among students and staff of Universiti Malaysia Kelantan (UMK). Lecture could be an important role to play in attracting more students and becoming a more healthy person. This could be one of steps to create a healthy community in Malaysia.

### ***Guidance and Counseling To Create A University Program***

From the study, they can create a healthy program at the university. This is because this program can attract students to know their health level and can create a healthy community in the future. This program can make students sensitive and aware of situations where any unhealthy activities can affect their learning and lifestyle. Guidance and counseling play a role in advising students to always be healthy.

### ***Institut Jantung Negara (IJN)***

From the research Institut Jantung Negara can play the role of guiding the community by using this research to create an event related to obesity. This data from the research could be used to find the fact that could affect the human body. Programs that involve the community can give health

warnings about obesity that could affect the human body. This way can create more health to the community by providing the event and advice to the community.

## LITERATURE REVIEW

### *Unhealthy Lifestyle*

It's completely obvious that university students live unhealthy lifestyles. Poor diet, excessive drinking, smoking, and insufficient sleep are all contributors to this. Therefore, given their hectic schedules, many students' health may ultimately suffer from a diet that lacks diversity and nutritious value, which is not ideal. (Griffin, 2016).

In connection with this, smoking is another bad habit that has an impact on kids. Students who only smoke when they go out on dates or socialize are known as "social smokers." The hazards of smoking do not go away even if you just smoke sometimes and "socially." Each cigarette raises the chance of developing lung, heart, and cancer problems, which together take up to six million lives annually. Even if they are only doing it "socially," Students must stop smoking since it is one of the biggest causes of mortality in the country. This is a likely scenario given that several countries throughout the world are supporting tobacco bans and beginning to oppose multinational cigarette companies (Chan, 2016).

### *Environment*

Social media is an environment that could have an impact on obesity. These days, social media, television shows, and smartphone applications heavily influence our eating habits and decision-making processes. Among the evidence, taking pictures of food for Instagram before eating, standing in long queues to buy the hot food or drink online, even filming their dinner live. This is usually driven by the desire to get "likes" and comments, which is a sense of enjoyment from the virtual world's attention. Sometimes trying new foods with friends is not wrong, but we need to be careful to what extent our food intake is influenced by social media and how not to be deceived (Yap, 2019).

Next, the pressure of environment also will face by students is mainly in terms of time and no breaks enough to cause them to choose to reduce stress by having fun and practicing unhealthy eating. The students will be extremely busy especially during exam week, because of that they will not maintain a good eating schedule, instead they will replace it with smoking and fast food. Some students do not eat during the day because they are busy with their assignments and they will fill the empty stomach with a late dinner, which is less than two hours before bedtime. In addition, there are also among students, especially male students who like to hang out in stalls or restaurants late at night.

### *Control Over Behaviour*

The core components of weight-control therapy for overweight and obese patients are behavioral modifications with an emphasis on dietary and physical activity improvements. At least temporarily, behavioral changes can aid in weight loss and improve their health. This list of behavioural treatments for managing student obesity is provided. A structured approach to changing lifestyle behaviours that may affect behaviour includes disciplines like exercise, food, and others. Goal-setting, stimulus control, stress factor legislation, ego, reorganisation of thought, stress management, figuring out solutions, and support systems are elements of behaviour modification.

More efficient and durable weight management can be accomplished by exercise, dietary modifications, and behavioural therapy. (Olateju et al., 2021). According to Radzi (2019), tension-producing situations not just the lack of social confidence and poor behavioral control among university students, but also elements like inadequate or disturbed sleep that can lead to obesity.

## ***Obesity***

One in five young people suffer from obesity, a complex chronic condition. Numerous pediatric treatment interventions concentrate on attempts to modify behaviour or lead healthier lifestyles, but they are constrained by their intensity and rendered ineffective by their inability to address the social circumstances of obesity. The study's main goal was to examine the existing treatment methods for obese patients by pediatric primary care providers (Johnson et al., 2022). Obesity that is chronic or non-communicable is now largely acknowledged as a disease. Recent research is shedding new light on the pathophysiology of unwelcome weight gain, the mechanisms by which obesity persists in the face of reasonable attempts to alter lifestyle choices, and the detrimental impact of both central and widespread obesity on health (Purnell, 2018). Males in the lowest income group (31.5%) and highest income bracket (32.6%) had the same frequency of obesity, whereas obesity rates of women dropped with rising income (from 45.2% to 29.7%) (Hales et al., 2017).

## **Research Hypothesis**

Literature review shows that independent variables such as unhealthy lifestyle, environment, and control over behaviour that influence weight management of obesity among student in Universiti Malaysia Kelantan. Therefore, the study proposes to examine the level of factors among these variables. Based on the literature discussed, the hypothesis of this study is summarized as follows:

**H1** There is a significant relationship between unhealthy lifestyle and obesity among student Universiti Malaysia Kelantan.

**H2** There is a significant relationship between environment and obesity among student Universiti Malaysia Kelantan.

**H3** There is a significant relationship between control over behaviour and obesity among student Universiti Malaysia Kelantan.

## **Research Framework**

The figure 1 below shows the research framework use for this study.

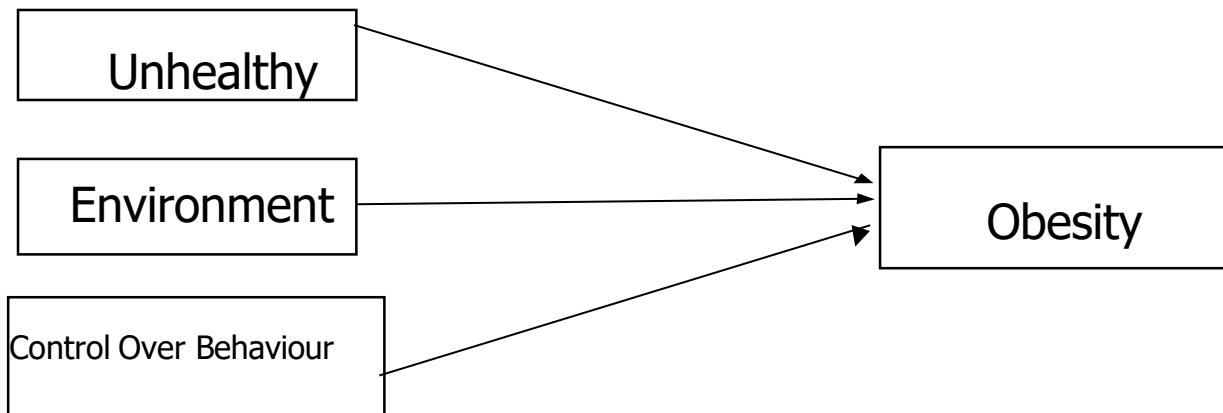

Figure 1: Research Framework

## **METHODOLOGY**

### **Research Design**

This research design is a framework that has been created to find the overall answers to the research questions conducted. The approach of this study is to use quantitative methods. A quantitative research approach has been used for weight management of obesity among student in Universiti Malaysia Kelantan. The quantitative approach means that it prioritises quantity. This is because this research will involve numbers, numerical or statistical data. The quantitative approach is structured, has clear scheduling, and focuses on results.



## **Data Collection**

Researchers collect primary data directly from primary sources such as survey like used a questionnaire through the Google form. The questionnaire is applied to collect the information regarding that lead to the factors that affecting weight management of obesity among student in Universiti Malaysia Kelantan. The questionnaire was distributed using an online platform to all students at Universiti Malaysia Kelantan. The questionnaire was distributed through online and social media like WhatsApp and collected data among the student.

## Sampling

The researchers use non-probability convenient sampling that include of factor related to Weight Management of Obesity among 120 respondent students in University Malaysia Kelantan from the population of 11 965 students. The researchers preferred to use this non- probability convenient sampling compared to probability samples which utilize mathematical procedures. In addition, this sampling technique is easy to do and does not use any cost required for this research. Respondents from the questionnaire were students in Universiti Malaysia Kelantan were selected for this survey. Respondents were selected to answer this questionnaire and all data were collected based on their answers.

## Data Analysis

Data analysis is a core element of the data analysis and Business Intelligence (BI) and is the method of gaining insights that guide business decisions making. A tool that is used in analyzing the data is a tool for Statistical Package Social Science (SPSS) version 29 programmed operation software. (SPSS) data, including such valid percentage and cumulative percentage, will be processed into statistics. To analyze the data, researchers have chosen easy descriptive analysis. The objective is to achieve a range of respondents correlated with different values of a single variable and to express these numbers in percentages. This technique is used by researchers because it is about interpreting and analyzing.

## FINDINGS

### Result of Frequency Analysis

Table 1 shows the result of frequency analysis of respondents.

Table 1: Frequency Analysis

Demographic characteristics	Frequency	Percentage (%)
<b>Gender</b>		
Male	60	50.0
Female	60	50.0
<b>Years of study</b>		
Year 1	15	12.5
Year 2	35	29.2
Year 3	64	53.3
Year 4	6	5.0
<b>Campus</b>		

Campus Bachok	38	31.7
Campus Jeli	20	16.7
Campus Kota	62	51.7
<hr/>		
<b>Age</b>		
18 – 21 years old	26	21.7
22 – 24 years old	87	72.5
25 and above	7	5.8
<hr/>		
<b>Race</b>		
Chinese	34	28.3
Indian	27	22.5
Malay	59	49.2
<hr/>		
<b>Religion</b>		
Buddha	25	20.8
Christian	11	9.2
Hindu	26	21.7
Muslim	58	48.3
<hr/>		
<b>Education Level</b>		
Degree	117	97.5
STPM/ Diploma	3	2.5
<hr/>		

Table 1 shows the result of frequency analysis of respondents. The research focus on student in Universiti Malaysia Kelantan. The result shows that the respondents were same on both which is 60 respondent (50%) for each genders. Next, majority of respondent come from year 3 which is 64 respondents which is (53.3%) while year 1 is 15 respondents with (12.5%), year 2 students with 35 respondents with (29.2%) and year 4 students with 6 respondents (5%). Next, the respondents mostly same from *Kampus Kota* which is 62 respondents which is (51.7%) while *Kampus Bachok* is 38 respondents which is (31.7%) and lastly *Kampus Jeli* is 20 respondents which is (16.7%). In addition, the ages of this result shows that from the ages 18 to 21 years old have 26 respondents which is (21.7%), 22 to 24 years old have 87 respondents which is (72.5%) and lastly 25 years old

have 7 respondents which are (7.8%). Next. The race of this result shows that mostly Malay have the highest which is 59 respondents which is (49.2%), Chinese is 34 respondents which is (28.3%) and lastly Indian which is 27 respondents with (22.5%). Next, the religion is show that muslim had the highest respons which is 58 respondents which is (48.3%) followed by Christian which is 11 respondents with (9.2%), Buddha with 25 respondents which is (20.8%) and lastly Hindu with 26 respondents with (48.3%). Lastly we have for educational level which is from degree there is 117 respondents which is (97.5%) and STPM/ Diploma with 3 respondents which is (2.5%).

### Result of Descriptive Analysis

Table 2 shows the result of descriptive analysis of variable.

Table 2: Descriptive Analysis

Variable	Items	Mean Score	Standard Deviation
<b>Obesity</b>	Do you believe your eating habits are the cause of your obesity condition?	4.66	0.572
	Is your physical health affected by obesity?	4.83	0.417
	Have your social life been limited because of obesity?	4.60	0.691
	Are you depressed because you are obese?	4.70	0.495
	Do you believe obesity has triggered depression?	4.66	0.615
	Do you believe that you can lose weight?	4.59	0.692
	Do you believe exercise will help you lose weight?	4.58	0.657
	Do you believe that eating too often is the cause of Obesity?	4.71	0.640
	I feel fun when I do exercise.	4.29	0.873
<b>Unhealthy Lifestyle</b>	I feel tired when I exercise regularly.	4.53	0.756
	I smoke cigarettes every day.	3.97	1.275
	I drink alcohol every day.	3.64	1.295
	I often eat fast food when I'm bored.	4.53	0.829
	I often eat foods high in sugar.	4.57	0.817

	I don't practice eating according to the food pyramid.	4.48	0.840
	I exercise less than 30 minutes a week.	4.50	0.879
<b>Environment</b>	I often eat excessively at night because I am tired and hungry when I get home.	4.52	0.733
	I often spend my free time playing video games, surfing the internet and watching television all day.	4.52	0.733
	I feel stress every day.	4.46	0.955
	I often go out gardening or walking in the park every evening.	4.08	0.161
	I exercise less than 30 minutes a day even on holidays.	4.38	0.989
	I regularly participate in doing household chores such as cooking, laundry and cleaning the home area.	4.19	0.955
	I often take 3 types of side dishes such as chicken, meat and eggs at the same time.	4.58	0.740
	I often eat rice in a day.	4.73	0.546
<b>Control Over behavior</b>	I always eat late at night when I come home tired.	4.52	0.778
	I always feel hungry even after eating.	4.45	0.915
	I don't see the benefit of doing exercise in my daily routine	4.38	1.046
	I have other work that must be completed instead of exercising.	4.53	0.756
	I feel not confident with myself every time doing an exercise in public.	4.63	0.607
	I feel fun when I do exercise everyday.	4.31	0.968
	I feel tired when do not doing my exercise regularly.	4.34	0.948
	I enjoy doing my exercising.	4.29	0.902

Table 2 was represented the descriptive analysis of variable. Based on dependent variable of this study, obesity descriptive analysis, the highest mean score is 4.83 it is "Is your physical

health affected by obesity” with standard deviation is (0.417) in our 52 research. Other than that, for the questions “Do you believe exercise will help you lose weight” has 4.58 the lowest mean score with (0.657) at standard deviation. Next, for the first independent variable, unhealthy lifestyle, questions number 6 " I often eat foods high in sugar” were showed the highest mean score, it is 4.57 with standard deviation is (0.817) in our research. In addition, for lowest of the mean score, which is “I drink alcohol everyday” which is 3.64 with standard deviation (1.295). Besides, for the second independent variable which is environment, the results of the highest mean score stated that question number 7, “I often take 3 types of side dishes such as chicken, meat and eggs at the same time.” With mean 4.58 SD= 0.740) while the results of the lowest mean score was stated that question number 4, “I often go out gardening or walking in the park every evening.” With (M= 4.08, SD= 1.161). Lastly, for the third independent variable which is control over behavior, the question number 4 with the greatest average score was "I have other work that must be completed instead of exercising." (Mean 4.53 SD= 0.756), while the question with the lowest average score was "I enjoy doing my exercising." (Mean 4.29 SD= 0.902).

### **Result of Reliability Analysis**

Table 3 shows the result of reliability analysis based on dependent variable and independent variable.

Table 3: Reliability Analysis

<b>Variable</b>	<b>Number of Items</b>	<b>Cronbach’s Alpha</b>
<b>Obesity</b>	8	0.743
<b>Unhealthy Lifestyle</b>	8	0.894
<b>Environment</b>	8	0.908
<b>Control Over Behavior</b>	8	0.902

Table 3 showed the results of the reliability analysis based on the dependent variable and each independent variable. The dependent variable which is obesity with 8 questions has Cronbach’s Alpha value of 0.743 which is good and acceptable. For the first independent variable, unhealthy lifestyle with 8 questions shows Cronbach’s Alpha value of 0.894 which is good, reliable and acceptable. The second independent variable, environment which contains 8 questions shows the Cronbach’s Alpha value of 0.908 which has very good internal consistency. The third independent variable, control over behavior with 8 questions in the questionnaire provided has Cronbach’s Alpha value of 0.902 which is reliable and very good.

## Result of Pearson Correlation Analysis

Table 4 shows the result of Pearson correlation analysis based on the hypothesis.

Table 4: Pearson Correlation Analysis

Hypothesis	P-Value	Result (Supported/ Not Supported)
<b>H1</b> - There is a significant relationship between unhealthy lifestyle and obesity among student Universiti Malaysia Kelantan.	0.001	H1 is supported
<b>H2</b> - There is a significant relationship between environment and obesity among student Universiti Malaysia Kelantan.	0.001	H2 is supported
<b>H3</b> - There is a significant relationship between control over behaviour and obesity among student Universiti Malaysia Kelantan.	0.001	H3 is supported

Table 4 shows the result of Pearson correlation analysis based on the hypothesis. According to the results, the significant p-value of H1 is 0.001 which is below 0.05 and the p-value is under

0.05. Thus, the study can reject the null hypothesis. Pearson Correlation value of 0.497 stipulates the strength of the relationship between unhealthy lifestyle and obesity is moderate and the result is supported. Next, the significant p-value of H2 is 0.001 which is below 0.05 and the p-value is under 0.05. Thus, the study can reject the null hypothesis. Pearson correlation value of 0.560 stipulates the strength of the relationship between environment and obesity is strong and the result is supported. Lastly, the significant p-value of H3 is 0.001 which is below

0.05 and the p-value is under 0.05. Thus, the study can reject the null hypothesis. Pearson Correlation value of 0.55 stipulates the strength of relationship between control over behavior and obesity is moderate and the results also is supported.

## DISCUSSION AND RECOMMENDATION

Discussions are aimed at solving questions and addressing hypotheses as mentioned in the first chapter of this study. In general, the study has extensively researched weight management of obesity among student in Universiti Malaysia Kelantan. The data collection of this purpose study is about how environment, control over factors and unhealthy lifestyle could bring obesity to an issue among students of Universiti Malaysia Kelantan. The data collection is using non probability convenience sampling.

The unhealthy lifestyle is the term where people are not following the guideline of being healthy by government or any sources. The student of student at Universiti Malaysia Kelantan. Just keep to unhealthy ways like eating junk foods, smoking and also less exercise. Unhealthy lifestyle can be measured using a food frequency questionnaire K:10. This questionnaire can be used to find the answer in this research. The environmental fact that causes obesity is by their surroundings. This is because of the location, curious nature, and also mindset. The strategic business location of a certain place that can allow people easily access it also can make obesity among students in Universiti Malaysia Kelantan.

Next, the curious nature of trying something new also could lead to obesity when trying almost all foods that attract people's appetite. Other than that, the mindset also could be one of the reasons why students in Universiti Malaysia Kelantan are having obesity problems. Next, the control over behavior is also one of the factors that cause obesity among students in Universiti Malaysia Kelantan. The behavior is more on physical inactivity, unproductive sport and also unhealthy diet. All these reasons could lead to obesity.

Several suggestions have been made to enhance our research for next studies. Future study on how to effectively control obesity among responders might be beneficial to other researchers. In order to attract attention throughout the whole study process, from conception to dispersal, we first considered to have a target for a long time period as researchers in order to demonstrate an extraordinary finding at the onclusion of study. Next, because of the limited time available, it is proposed that future researchers broaden the unit's scope in order to generate their studies with a bigger target audience from only one particular course of students at Universiti Malaysia Kelantan (UMK). Future researchers intend to use other independent variables to affect how important weight management is to our continued existence in society. The surroundings significantly contributes to promoting weight management and simplifying daily movement plans. This would be an appropriate proposal given the importance of the independent variables. Lastly, future researchers shouldn't depend just on surveys for gathering

results. Face-to-face interviews will be employed in the future to get direct information from respondents. As a result, it was possible to contribute to the study with data than was more precise, reliable, and valuable.



## CONCLUSION

In conclusion, the study has been accomplished to discover the factors that affecting weight management of obesity among student in Universiti Malaysia Kelantan. Three independent variables, namely unhealthy lifestyle, environment and control over behaviour have been chosen to examine their relationships with the dependent variable, which is obesity. A total of 120 respondents from the age of 18 years old and 25 years above were selected from students in Universiti Malaysia Kelantan. Overall, based on Pearson's correlation analysis, environment factors have the strongest correlation compared to another factors which is followed by control over behaviour factors and the least unhealthy lifestyle factors.

## REFERENCES

- Abdullah, N.-F., Teo, P. S., & Foo, L. H. (2016). Ethnic Differences in the Food Intake Patterns and Its Associated Factors of Adolescents in Kelantan, Malaysia. *Nutrients*, 8(9), 551.
- Akter, M., Sadekin, M. N., & Patwary, A. K. (2020). An Empirical Study on Students' Satisfaction from Mawlana Bhashani Science & Technology University, Bangladesh. *Review of Economics and Development Studies*, 6(2), 363-379.
- Alom, S., Patwary, A. K., & Khan, M. M. H. (2019). Factors affecting the turnover intention of Bangladeshi migrants in the United Arab Emirates: An empirical study on the hotel industry. *International Journal of Innovation, Creativity and Change*, 8(3), 344-360.
- Fengmin, Z., Baijun, W., Jiangtao, B., Li, L., & Patwary, A. K. (2022). Investigating revisit intention of medical tourists in China through nutritional knowledge, perceived medical quality, and trust in the physiologist: A recommendation on health tourism policy measures. *Frontiers in Public Health*, 10, 893497.
- Hazbar, A. M. H., Alem Mohammed, A., & Karim, A. K. A. (2019). An Empirical Study of Factors Influencing hotel customers' online booking Intention. *مجلة العلوم التربوية و الدراسات الإنسانية*, 5(5), 1-17.
- Hu, L., Huang, X., You, C., Li, J., Hong, K., Li, P., Wu, Y., Wu, Q., Wang, Z., & Gao, R.
- I. S. (2019). Underweight, overweight, and obesity as independent risk factors for hospitalization in adults and children from influenza and other respiratory viruses. *Influenza and other respiratory viruses*, 13(1), 3-9.
- Julia Tong, T., Mohammadnezhad, M., Salem Alqahtani, N., & Salusalu, M. (2022). Perception of students on factors contributing to overweight and obesity among high school students in Kiribati: A qualitative study. *PloS one*, 17(1), e0260900.
- Kwok, S., Adam, S., Ho, J. H., Iqbal, Z., Turkington, P., Razvi, S., Le Roux, C. W., Soran, H., & Syed, A. A. (2020). Obesity: A critical risk factor in the COVID-19 pandemic. *Clinical Obesity*, 10(6), e12403
- Li, L., Ragavan, N. A., Patwary, A. K., & Baijun, W. (2022). Measuring patients' satisfaction toward health tourism in Malaysia through hospital environment,

- nutritional advice, and perceived value: A study on Chinese exchange students. *Frontiers in public health*, 10, 893439.
- Li, L., Wu, B., & Patwary, A. K. (2022). How marine tourism promote financial development in sustainable economy: new evidences from South Asia and implications to future tourism students. *Environmental Science and Pollution Research*, 29, 1155-1172.
- Li, L., Wu, B., & Patwary, A. K. (2022). The psychosocial factors affecting chinese Outbound Exchange and mobility students' academic performance during COVID-19. *Frontiers in psychology*, 13, 872516.
- Moser, J. A. S., Galindo-Fraga, A., Ortiz-Hernández, A. A., Gu, W., Hunsberger, S., Galán-Herrera, J. F., Guerrero, M. L., Ruiz-Palacios, G. M., Beigel, J. H., & Group, L. R.
- Patwary, A. K., Roy, B., Hoque, R., & Khandakar, M. S. A. (2019). Process of developing a community based tourism and identifying its economic and social impacts: An Empirical study on Cox's Bazar, Bangladesh. *Pakistan Journal of Humanities and Social Sciences*, 7(1), 1-13.
- Schwartz, M. W., Seeley, R. J., Zeltser, L. M., Drewnowski, A., Ravussin, E., Redman, L. M., & Leibel, R. L. (2017). Obesity Pathogenesis: An Endocrine Society Scientific Statement. *Endocrine Reviews*, 38(4), 267- 296.
- Sumethokula, P., Patwary, A. K., Srinuanpanc, B., Srinuanpand, C., Suwandee, P., Thammathikulf, A., & Phanong, W. (2020). The potential of new tour repackaging for creative tourism among entrepreneurs in Nakhon Si Thammarat. *International Journal of Innovation, Creativity and Change*, 13(10), 1752-1771.
- Wan Mohamed Radzi, C. W. J., Salarzadeh Jenatabadi, H., Alanzi, A. R. A., Mokhtar, M. I., Mamat, M. Z., & Abdullah, N. A. (2019). Analysis of Obesity among Malaysian University Students: A Combination Study with the Application of Bayesian Structural Equation Modelling and Pearson Correlation. *International Journal of Environmental Research and Public Health*, 16(3), 492.
- Wu, B., Liu, S., Wang, J., Tahir, S., & Patwary, A. K. (2021). Assessing the mechanism of energy efficiency and energy poverty alleviation based on environmental regulation policy measures. *Environmental Science and Pollution Research*, 28, 40858-40870.
- Wu, B., Zhai, B., Mu, H., Peng, X., Wang, C., & Patwary, A. K. (2021). Evaluating an economic application of renewable generated hydrogen: A way forward for green economic performance and policy measures. *Environmental Science and Pollution Research*, 1-15.

# **Factors Affecting Stress Among First-Year Students Fakulti Hospitaliti, Pelancongan & Kesejahteraan (FHPK) At Universiti Malaysia Kelantan.**

**Norhapija Binti Timhar, Norsyafiqah Binti Mohd Ali, Thinosha A/P V.Krishan, Wan Nur Amy Suraya Binti Wan Muhammad Zaki \*Mohd Hafzal Bin Abdul Halim**

*Faculty of Hospitality, Tourism and Wellness, Universiti Malaysia Kelantan  
Corresponding email: [hafzal@umk.edu.my](mailto:hafzal@umk.edu.my)*

---

## **ABSTRACT**

*Stress is a mental strain for actual people dealing with the environmental and societal factors that influence so many disorders. Young age is an important stage since young individuals are undergoing many changes at this age. Consequently, it's important to understand the causes of stress, which mainly include the following: academic, family issues, and peer pressure. Sometimes such stress can result in behavior, physical, and psychological problems. In addition, to ensure the contributing stress of each student is guaranteed the person must carry out a research method which is the factors that affect stress among first-year students of Fakulti Hospitaliti, Pelancongan dan Kesejahteraan (FHPK) at Universiti Malaysia Kelantan. This research is also done qualitatively. This method is crucial in determining what kind of observation should be used to obtain information on factors that affect stress among first-year students of Fakulti Hospitaliti, Pelancongan dan Kesejahteraan. The purpose of the research methodology is to data collection, processing, and analysis in an organized and effective manner to finish a study.*

**Keywords: Academic, Family Issues, Peer Pressure, Stress**

---

## **INTRODUCTION**

Elizabeth (2020) defines stress as any type of shift that results in tension in the body, mind, or emotions. Stress also refers to anything that stimulates the body to react with inquiry or reaction. Nevertheless, students who pursue higher education in Malaysia face a lot of responsibility and pressure since they must undergo the process of adapting to a new social and educational environment (Malarvili & Dhanapal, 2018). Therefore, if the issue persists, it can eventually result in stress-related illnesses like depression, anxiety, insomnia, loneliness, interpersonal and intrapersonal disputes, and other mental health issues.

Next, students who experience too much stress face physical problems such as sweating for no reason, headaches, fatigue, stomach aches, and difficulty or lack of sleep (Felman, 2020). Hence, these students also mentioned that they felt they needed to put their assessment on wait to participate in social, physical, and restorative activities that could promote their well-being and healthy self-growth. The students' inability to maintain a balance had a negative impact on their concentration towards their academic pursuits. Therefore, the primary goal of this study is to investigate the factors that affect stress levels in first-year students enrolled in the Faculty of Hospitality, Tourism, and Wellness (FHPK) at Universiti Malaysia Kelantan. There were three objectives of this research:

1. To investigate the relationship between academic factors with the stress faced among first-year students of Fakulti Hospitaliti, Pelancongan and Kesejahteraan (FHPK) at Universiti Malaysia Kelantan.
2. To investigate the relationship between family issue factors with the stress faced among first-year students of Fakulti Hospitaliti, Pelancongan and Kesejahteraan (FHPK) at Universiti Malaysia Kelantan.
3. To investigate the relationship between peer pressure factors with the stress faced among first-year students of Fakulti Hospitaliti, Pelancongan and Kesejahteraan (FHPK) at Universiti Malaysia Kelantan.

## **SIGNIFICANCE OF THE STUDY**

### ***Malaysian Ministry of Higher Education (MOHE)***

The Malaysian Ministry of Higher Education (MOHE) can identify the stress factors faced by students who have just entered University. Therefore, the MOHE must seriously consider the stressors that Malaysian Higher Education Institutions' students face, and it must develop thoughtful initiatives, like awareness campaigns. This is crucial to reduce the signs of stress in first-year university students.

### ***Faculty at Universiti Malaysia Kelantan***

This study also helps the faculty at each campus of Universiti Malaysia Kelantan to find out that academic factors, family problems, and peer pressure affect the stress faced by first-year students who live in residential colleges.

### ***Counseling Department***

This study can help the counseling department to identify students who experience stress during their stay at the residential college at Universiti Malaysia Kelantan. Hence, the counseling department should conduct awareness campaigns periodically by providing counseling services for those who experience stress during their studies at Universiti Malaysia Kelantan.

### ***Family Institutions***

Family is the closest person to every university student (Stacy, 2020). As such, family institutions play an important role in providing moral support for children so that they can overcome stress problems throughout their studies at the university level.

## **LITERATURE REVIEW**

### ***Stress***

First-year university students frequently experience stress. According to Garrett et al. (2017), female undergraduate students are more stressed than their male peers, and several academic majors such as engineering and medicine are also linked to higher stress levels. Stress can have a variety of severe effects on undergraduate students, including inadequate academic performance, health issues, increased depression,

increased alcohol, drug, and use of stimulants, a low sense of value, and suicide thoughts.

Besides that, students who experience too much stress face physical problems such as sweating for no reason, headaches, fatigue, stomach aches, and difficulty or lack of sleep (Felman, 2020). Hence, these students also mentioned that they felt they needed to put their assessment on wait to participate in social, physical, and restorative activities that could promote their well-being and healthy self-growth. This lack of balance affected their ability to focus on their studies. Furthermore, undergraduate students experience higher rates of depression, anxiety, and stress, as reported by Choon et al. in 2015. This can be linked to various factors such as the immense volume of material they need to grasp within limited time frames, unexpected alterations in their study routines, concerns about their performance and the possibility of failure in exams, and the lack of allocated time for clinical postings..

### *Academic*

In a study conducted by Johari and Ahmad (2019), it was found that stress among college students primarily arises from academic factors, which serve as the main contributors. There are also a number of other elements, including social and physical aspects. Similarly, Irshad et al. (2015) stated that students often experience pressure related to their workload, relationships with friends, family, and professors. This pressure stems from the need to consistently produce good results and complete assignments punctually without any shortcomings. In addition, a study in South Africa found that to overcome academic pressure is to use prohibited substances that students tend to use (Olufunke, 2017). Nevertheless, the use of alcohol also often happens to some students because it is a way for students to reduce stress when studying (Metzger et al., 2017). Students frequently employ this technique because they believe it will help them cope with the pressure of studying, especially those with high levels of stress who may experience low energy, loss of appetite, headaches, insomnia, or digestive issues because of the academic pressure they are under (Malarvili & Dhanapal, 2018).

According to Mofatteh (2021) studied the effects of excessive academic pressure on mental health, including depression, anxiety, and suicide ideation. Apart from that, the educational system may also play a role in increasing stress levels. Overcrowding in lecture halls, insufficient resources and facilities, long hours, and rote learning expectations are some of the sources of stress in the educational system (Deb et al., 2015). This is because these causes are one of the things that students often experience, especially first-year students who have not yet been able to adapt to the system, thus having a big impact on the students. Academic pressure consequently becomes one of the factors that university students, particularly first-year students who must adjust to new circumstances, encounter when they are stressed.

### *Family Issues*

The term "stress" is frequently used to describe situations that make students feel anxious and frustrated because they are beyond the capacity for effective coping. According to Spinelli et al. (2020), there is strong evidence that family issues have an impact on stress levels. Researchers discovered that most stressed-out students came from families that have divorced. Parental separation can occur for a number of reasons, including poor communication and financial difficulties. When these issues arise, the marriage becomes stressed and separated, which has a significant effect on their children. Apart from that, according to Pedersen (2022), since it is generally recognized that both levels of stress may negatively impact children's well-being, researchers

looked at both individual parents' stress and dyadic perceptions of stress. However, (Haimi & Lerner 2016) found that 19 family conflict occurrences may exacerbate parents' psychological issues, including stress on an individual and dyadic level, with a negative impact on children's emotional and behavioral health as a result.

In addition, researchers look at the difficulties that students confront when they have family members who abuse alcohol and or drugs. Ólafsdóttir et al., (2018) proved that there is a direct link between family relationship addiction and disturbance, as well as important psycho-social and physical repercussions on family members like depression, anxiety, and stress. The emotional, physical, and social needs of the children may be neglected as a result of the depression of a parent who cohabits with a partner who uses drugs or alcohol, which heightens family conflict and anxiety. Besides that, the sadness of the parent who shares a home with a partner who has a substance use disorder (SUD) may result in the emotional, physical, and social neglect of the family's children, which increases anxiety and tension in the household. However, according to Lassonde (2022), children who observe parental conflict, illness, and financial difficulty as the source of the subpar living conditions the family must endure generally have a traumatic family experience with adverse psycho social impacts.

### ***Peer Pressure***

According to Khanagha et al. (2021), Peer pressure is the process by which a social group exerts influence over an individual. Peer pressure is a social dynamic that people have encountered, and it is a result of the daily interactions that students have with other people. Students experience peer pressure to fit in with the group of peers they hang out with (Dhull & Beniwal, 2017). However, there are situations when students' peers are the cause of their stress. They might exert pressure on them to do things they don't want to, such as shoplifting, smoking cigarettes or alcohol, impersonating someone else while driving, and more. Hence, students may be teased by a peer to imitate their actions. Furthermore, sometimes peers would not even speak to the students. Instead, they may pressure them by labeling them as outcasts or ignoring them. This behavior also caused stress among the students. Glass (2020) stated that when someone ignores someone, they experience a variety of conflicting feelings. They might experience a variety of emotions at once, including sadness, loneliness, guilt, and anger. Naturally, such an emotional crisis might hurt their mental health. It also can cause emotional trauma to first-year students and leads to stress.

### **Research Hypothesis**

The literature review highlighted independent variables like academic, family issues, and peer pressure affecting stress among first-year students of Fakulti Hospitaliti, Pelancongan & Kesejahteraan (FHPK) at Universiti Malaysia Kelantan. Based on the literature discussed, the hypotheses of this study were summarized in the following manner:

**H<sub>1</sub>** There is a significant relationship between academic factors with the stress faced among first-year students of Fakulti Hospitaliti, Pelancongan & Kesejahteraan (FHPK) at Universiti Malaysia Kelantan.

**H<sub>2</sub>** There is a significant relationship between family issue factors with the stress faced among first-year students of Fakulti Hospitaliti, Pelancongan & Kesejahteraan (FHPK) at Universiti Malaysia Kelantan.

**H<sub>3</sub>** There is a significant relationship between peer pressure factors with the stress faced among first-year students of Fakulti Hospitaliti, Pelancongan & Kesejahteraan (FHPK) at Universiti Malaysia Kelantan.

### Research Framework

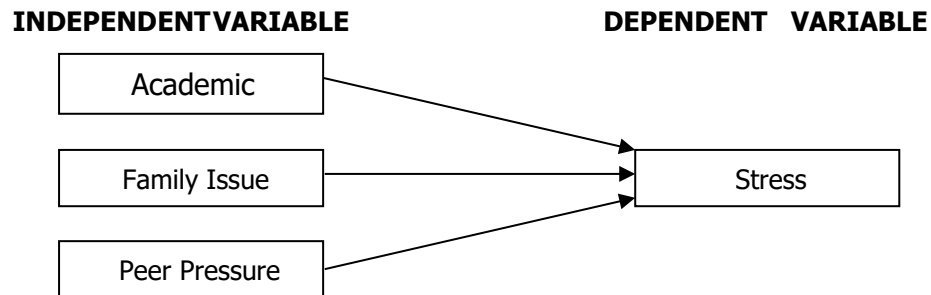

Figure 1 Research Framework

Figure 1 displays the study's research framework, emphasizing the independent variable (IV) and dependent variable (DV). The study focuses on first-year students at Universiti Malaysia Kelantan's Fakulti Hospitaliti, Pelancongan & Kesejahteraan (FHPK), and investigates the elements that influence stress. Academic factors, familial issues, and peer pressure are the three key independent variables. The stress experienced by FHPK first-year students is the dependent variable. The graph depicts the association between these variables and the pupils' stress levels. It emphasizes the relationship between the independent variable and the dependent variable, providing insights into the interplay between the factors that influence stress levels in first-year students from the FHPK group at Universiti Malaysia Kelantan.

## METHODOLOGY

### Research Design

This study used a quantitative research approach to collect significant data. Since quantitative surveys use closed-ended questions, the results can easily be turned into numbers, statistics, graphs, and charts (Thakur 2021).

### Data Collection

In this study, the primary approach for gathering data is through the use of a questionnaire. The researcher opted to utilize Google Forms as the platform for distributing the questionnaire due to its convenience and efficiency in reaching a larger number of participants in a shorter period. Specifically, the questionnaire was targeted at first-year students of FHPK at Universiti Malaysia Kelantan. The aim of the questionnaire was to gain insights into the stress experiences encountered by these students.

### Sampling

The researchers used non-probability sampling techniques, which means that instead of selecting samples randomly, the researcher chose samples based on their own judgment and assessment. Additionally, convenience sampling was also a component of the non-probability sampling strategy that the researchers employed for this study.

Therefore, convenience sampling is the practice of selecting 260 respondents from the population among first-year students of FHPK Universiti Malaysia Kelantan only. This is because the samples are convenient for the researchers.

## Data Analysis

This study utilizes descriptive statistics to analyze the data and understand its fundamental characteristics. Gupta et al. (2019) state that descriptive statistics offer simple explanations of the sample and measurements. However, in this study, the researchers also employ Pearson's Correlation, which examines the relationship between independent and dependent variables. Additionally, Cronbach's alpha is used to assess the accuracy of the questionnaire findings and the quality of the output. Both dependent and independent variables are investigated using Cronbach's alpha coefficient. The data analysis was conducted using Statistical Package for Social Science (SPSS) version 26.0.

## FINDINGS

### Demographic Analysis

Table 1 Demographic Analysis

Demographic Profile	Frequency	Percentage (%)
<b>Gender</b>		
Male	98	37.7
Female	162	62.3
<b>Age</b>		
18 – 21 years old	205	78.8
22 – 24 years old	49	18.8
25 years old and above	6	2.3
<b>Marital Status</b>		
Single	253	97.3
Married	7	2.7
<b>Ethnicity</b>		
Malay	154	59.2
Chinese	38	14.6
Indian	55	21.2
Other	13	5.0
<b>Course</b>		
SAH	69	26.5
SAP	95	36.5
SAS	96	36.9
<b>Stress Level</b>		
Never	32	12.3
Seldom	120	46.2
Frequent	88	33.8
Very Often	20	7.7

Table 1 indicates the frequency of demographic analysis, with 162 female respondents (62.3%) outnumbering male respondents (98 with 37.7%). In terms of age, 18 - 21 year old accounted for 205 respondents, accounting for 78.8% of the total. 49 respondents (18.8%) represented respondents who were between the ages of 22 to 24. Furthermore, respondents aged 25 and up reported 6 people (2.3%). According on the statistics on respondents' marital status, the majority of single respondents (97.3%) and 7 married respondents (2.7%) answered this questionnaire. Next, the majority of Malays responded to this survey, with a total of 154 people (59.2%), followed by



Indians 55 people (21.2%). Meanwhile, the Chinese showed 38 respondents answering this survey with 14.6% of and other races as many as 13 respondents (5.0%). For respondent data from the costs found in the FHPK shows a total of 69 respondents from the Ijazah Sarjana Muda (Hospitaliti) Dengan Kepujian (SAH) course shows 69 respondents (26.5%), the Ijazah Sarjana Muda Pelancongan) Dengan Kepujian (SAP) course shows 95 respondents (36.5%) and lastly from the Ijazah Sarjana Muda (Kesejahteraan) Dengan Kepujian (SAS) course showed a total of 96 respondents with 376.9%. The number of first-year students who reported experiencing stress ranged from 32 respondents (12.3%) to 120 respondents (46.2%), from 88 respondents (33.8%) to 20 respondents (7.7%), and from never to 120 to often to often.

## Descriptive Analysis

Table 2 Descriptive Analysis.

Variables	Items	Mean Score (M)	Standard Deviation (SD)
<b>Stress</b>	I find it hard to keep calm.	3.17	1.279
	I tend to overreact to a situation.	2.94	1.197
	I think I am too nervous.	3.02	1.195
	I get restless easily.	3.12	1.235
	I find it hard to relax.	2.97	1.225
	I cannot accept anything that stops me from continuing what I'm doing.	2.99	1.149
	I am easily offended.	3.14	1.147
	I feel loaded down with responsibility.	3.18	1.171
	I'm easily feel discouraged.	3.16	1.133
	I have not enough time for myself.	3.14	1.197
<b>Academic</b>	I have a financial problem because of the expenses of the university	3.36	1.255
	I find it difficult to juggle time between study and social activity.	3.04	1.100
	I feel nervous about delivering the class presentation.	3.47	1.144
	I feel stressed as the submission deadline neared.	3.33	1.121
	I feel stressed to sit for the examination.	3.27	1.107
	I find it difficult to juggle time between study and society involvement.	3.15	1.088
	I lost interest in courses.	2.95	1.145
	I feel burdened by academic workloads.	3.24	1.144
	I feel stressed dealing with a difficult subject.	3.41	1.110
	I feel difficult in managing my academic problem.	3.20	1.086
<b>Family Issue</b>	My families are not supportive.	1.84	1.106
	I had trouble with my siblings.	1.97	1.074
	My parents frequently argue at home.	1.84	1.048
	My parents regularly make comparisons to other people.	2.08	1.098
	I have been arguing more with my parents.	1.94	1.078
	My family and I have financial difficulties.	2.30	1.193
	My parents expecting too much of me.	2.52	1.284
	I feel so bad if I don't measure up to my parent's expectations.	2.94	1.439
	I am treated like a helpless person by my family.	1.92	1.055
I never had the freedom to choose in my life because my parents always made decisions for me.	1.96	1.039	
<b>Peer Pressure</b>	I have friends that influence how I think.	3.45	1.292
	I make decisions based on peer pressure.	3.09	1.350
	I follow what my peers are telling me to do.	2.98	1.300
	I experience stress because my peers avoid me.	3.17	1.321
	I miss home because of my peer's pressure.	3.12	1.336

My friends pressure me to act in a harmful way.	2.92	1.428
I am stressed out because one of my friends convinced me to skip class.	2.81	1.375
I act differently when I am with my friends than when I'm at home.	3.22	1.318
I am stressed out because my friend talks behind me and betrays me.	3.22	1.343
I am anxious because I let a friend to steal my work, and I'm concerned that my lecturer will find out.	3.22	1.312

Table 2 presents a descriptive analysis of the stress variable. It reveals that the item "I have friends that influence how I think" received the highest mean score (M=3.18, SD=1.171), indicating a significant impact on stress levels. Conversely, the item "I tend to overreact to a situation" received the lowest mean score (M=2.94, SD=1.197), suggesting a relatively lower influence on stress. Regarding the independent variable of academic factors, the item "I feel stressed dealing with a difficult subject" obtained the highest mean score (M=3.41, SD=1.110), indicating a substantial impact on stress related to academics. On the other hand, the item "I lost interest in courses" received the lowest mean score (M=2.95, SD=1.145), suggesting a relatively lesser impact on academic stress. For family issues, the item "I feel so bad if I don't measure up to my parent's expectations" received the highest mean score (M=2.94, SD=1.439), indicating a significant impact on stress related to family expectations. However, the items "My families are not supportive" (M=1.84, SD=1.106) and "My parents frequently argue at home" (M=1.84, SD=1.048) received the lowest mean scores, indicating a relatively lower impact on stress within the family context. Lastly, in terms of peer pressure, the item "I have friends that influence how I think" obtained the highest mean score (M=3.45, SD=1.292), suggesting a strong influence on stress levels. On the other hand, the statement "I feel stressed because a friend persuaded me to miss class" had the lowest average rating (M=2.81, SD=1.375), suggesting that it had a relatively minor effect on stress resulting from peer influence.

## Reliability Analysis

Table 3 Reliability Analysis

Variables	Cronbach's Alpha	No. of Items
Academic	.920	10
Family issues	.903	10
Peer pressure	.954	10
Stress	.922	10

Table 3 showed the results of the reliability analysis based on the independent variable and dependent variable which include academic (0.920), family issues (0.903), peer pressure (0.954), and stress (0.922). According to Cronbach's Alpha coefficient scale, all these variables show excellent coefficient and the questionnaire were reliable to use.

## Pearson Correlation Analysis

Table 4 Pearson Correlation Analysis

Hypothesis	P-Value	Result (Supported/ Not Supported)
H <sub>1</sub> There is a significant relationship between academic factors with the stress faced among first-year students of Fakulti Hospitaliti, Pelancongan & Kesejahteraan (FHPK) at Universiti Malaysia Kelantan.	0.000	H <sub>1</sub> is supported

<b>H<sub>2</sub></b> There is a significant relationship between family issue factors with the stress faced among first-year students of Fakulti Hospitaliti, Pelancongan & Kesejahteraan (FHPK) at Universiti Malaysia Kelantan.	0.013	H2 is supported
<b>H<sub>3</sub></b> There is a significant relationship between peer pressure factors with the stress faced among first-year students of Fakulti Hospitaliti, Pelancongan & Kesejahteraan (FHPK) at Universiti Malaysia Kelantan.	0.000	H3 is supported

Table 4 presents the results of a Pearson correlation analysis conducted to test specific hypotheses. The findings demonstrate the statistical significance of the hypotheses under investigation. Hypothesis 1 (H1) yielded a significant value of less than 0.05. When the p-value falls below this threshold, researchers accept the alternative hypothesis in favor of the null hypothesis. In this case, the p-value being less than 0.05 suggests a significant association, and therefore, the alternative hypothesis is supported. Similarly, Hypothesis 2 (H2) produced a significant value of 0.013, which is also below the 0.05 threshold. Consequently, researchers reject the null hypothesis and accept the alternative hypothesis, indicating a meaningful relationship between the variables. Furthermore, Hypothesis 3 (H3) exhibited a significant value of less than 0.05, indicating a highly significant association. With the p-value being less than 0.05, researchers accept the alternative hypothesis and reject the null hypothesis, suggesting a strong relationship between the variables. Ultimately, since all the hypotheses yielded p-values below 0.05, they are considered supported. The significance level of 0.05 is commonly used as a threshold in statistical analyses to determine the strength of evidence against the null hypothesis.

## DISCUSSION AND RECOMMENDATION

The discussion is to investigate the link between academic, family issues, and peer pressure elements and stress among first-year students at Fakulti Hospitaliti, Pelancongan, and Kesejahteraan (FHPK) at Universiti Malaysia Kelantan. The study's key findings reveal that academic, family issues and peer pressure had a significant association with stress in this study. Subsequently, previous research showed a significant relationship between academic, family, and peer pressure with stress.

The recommendation is to distribute the questionnaire physically or face to face to collect data. This is because it is simpler to persuade responders to spend the time to complete the questionnaire. Furthermore, respondents cannot give inaccurate information throughout the inquiry, such as gender, age, or race. In online and mobile surveys, the provision of incentives can lead to people falsifying their responses. This is because individuals might provide incorrect demographic information in order to complete the questionnaire quickly and receive the incentive.

Next the questions asked must use a language or reduce questions that are easier to understand. This is because the researcher has examined that there is a small number of respondents who do not understand the questions presented and choose not to answer. The questions that need to be submitted for future studies must be brief and related to a specific study. Third, reduce the number of respondents for the target population. This is because the researcher took a long time to find respondents due to the relatively large number. The target population should be changed from the entire first-year students to the student population for each course, for example, a study of first-year students from a wellness course. This helps researchers obtain and analyze data easily.

## **CONCLUSION**

First-year students in the Fakulti Hospitaliti, Pelancongan & Kesejahteraan (FHPK) at Universiti Malaysia Kelantan often face challenges related to stress, which can have adverse effects on their well-being. However, these individuals can potentially overcome this issue by employing effective coping techniques. Stress is a common problem experienced by university students on a daily basis, stemming from various factors such as academic pressure, peer pressure, and family issues. The stressors associated with academic performance, maintaining peer relationships, and dealing with family problems can all contribute to the overall stress levels. It is crucial to address stress promptly, as untreated stress may escalate into more severe mental conditions like depression or anxiety disorders.

## REFERENCES

- Felman, A. (2020, March 12). *Why stress happens and how to manage it*. Medicalnewstoday.com; Medical News Today.
- Akter, M., Sadekin, M. N., & Patwary, A. K. (2020). An Empirical Study on Students' Satisfaction from Mawlana Bhashani Science & Technology University, Bangladesh. *Review of Economics and Development Studies*, 6(2), 363-379.
- Alom, S., Patwary, A. K., & Khan, M. M. H. (2019). Factors affecting the turnover intention of Bangladeshi migrants in the United Arab Emirates: An empirical study on the hotel industry. *International Journal of Innovation, Creativity and Change*, 8(3), 344-360.
- Deb, S., Esben Strodl, & Sun, J. (2015). *Academic Stress, Parental Pressure, Anxiety and Mental Health among Indian High School Students*. ResearchGate; unknown.
- Elizabeth. (2020). *Defining biological stress and stress responses based on principles of physics*. 333(6), 350–358.
- Fengmin, Z., Baijun, W., Jiangtao, B., Li, L., & Patwary, A. K. (2022). Investigating revisit intention of medical tourists in China through nutritional knowledge, perceived medical quality, and trust in the physiologist: A recommendation on health tourism policy measures. *Frontiers in Public Health*, 10, 893497.
- Garett, R., Liu, S., & Young, S. D. (2017, March 31). *A Longitudinal Analysis of Stress Among Incoming College Freshman*. ResearchGate; Taylor & Francis (Routledge).
- Glass, L. J. (2020, February 25). *Why The Silent Treatment Is Damaging | #1 Emotional Intimacy Coaching*. Pivot.
- Gupta, A., Mishra, P., Pandey, C., Singh, U., Sahu, C., & Keshri, A. (2019). Descriptive statistics and normality tests for statistical data. *Annals of Cardiac Anaesthesia*, 22(1), 67.
- Haimi, M., & Lerner, A. (2016). The impact of parental separation and divorce on the health status of children, and the ways to improve it. *Journal of Clinical & Medical Genomics*, 4(1).
- Hazbar, A. M. H., Alem Mohammed, A., & Karim, A. K. A. (2019). An Empirical Study of Factors Influencing hotel customers' online booking Intention. *مجلة العلوم التربوية و الدراسات الإنسانية*, (5), 1-17.
- Johari, M. A., & Ahmad, S. (2019). Persepsi tekanan akademik dan kesejahteraan diri di dalam kalangan pelajar universiti di Serdang, Selangor. *EDUCATUM Journal of Social Sciences*, 5(1), 24–36.
- Lassonde, K. (2022, February 15). *Student research report: Coping mechanisms for stressed-out college students*. Communicating Psychological Science.
- Li, L., Ragavan, N. A., Patwary, A. K., & Baijun, W. (2022). Measuring patients' satisfaction toward health tourism in Malaysia through hospital environment, nutritional advice, and perceived value: A study on Chinese exchange students. *Frontiers in public health*, 10, 893439.
- Li, L., Wu, B., & Patwary, A. K. (2022). How marine tourism promote financial development in sustainable economy: new evidences from South Asia and implications to future tourism students. *Environmental Science and Pollution Research*, 29, 1155-1172.
- Li, L., Wu, B., & Patwary, A. K. (2022). The psychosocial factors affecting chinese Outbound Exchange and mobility students' academic performance during COVID-19. *Frontiers in psychology*, 13, 872516.

- Mofatteh, M. (2021). Risk factors associated with stress, anxiety, and depression among university undergraduate students. *AIMS Public Health*, 8(1), 36–65.
- Ólafsdóttir, J., Hrafnadóttir, S., & Orjasniemi, T. (2018). Depression, anxiety, and stress from substance-use disorder among family members in Iceland. *Nordic Studies on Alcohol and Drugs*, 35(3), 165–178.
- Olufunke, B. R. (2017). Academic stress and drug abuse as factors inhibiting psychological well-being among undergraduates: It's counselling implications. *European Scientific Journal, ESJ*, 13(8), 60.
- Patwary, A. K., Roy, B., Hoque, R., & Khandakar, M. S. A. (2019). Process of developing a community based tourism and identifying its economic and social impacts: An Empirical study on Cox's Bazar, Bangladesh. *Pakistan Journal of Humanities and Social Sciences*, 7(1), 1-13.
- Pedersen, T. (2022, July 13). *How Does Stress Affect Child Development?* Psych Central; Psych Central.
- Ramachandiran Malarvili, & Saroja Dhanapal. (2018, September). *Academic stress among university students: A quantitative study of generation Y and Z's perception*. ResearchGate; unknown.
- Stacy Lee Kong. (2020, October 8). *University students remain closely tied to their parents—emotionally and otherwise - Macleans.ca*. Macleans.ca.
- Sumethokula, P., Patwary, A. K., Srinuanpanc, B., Srinuanpand, C., Suwandee, P., Thammathikulf, A., & Phanong, W. (2020). The potential of new tour repackaging for creative tourism among entrepreneurs in Nakhon Si Thammarat. *International Journal of Innovation, Creativity and Change*, 13(10), 1752-1771.
- Wu, B., Liu, S., Wang, J., Tahir, S., & Patwary, A. K. (2021). Assessing the mechanism of energy efficiency and energy poverty alleviation based on environmental regulation policy measures. *Environmental Science and Pollution Research*, 28, 40858-40870.
- Wu, B., Zhai, B., Mu, H., Peng, X., Wang, C., & Patwary, A. K. (2021). Evaluating an economic application of renewable generated hydrogen: A way forward for green economic performance and policy measures. *Environmental Science and Pollution Research*, 1-15.

# **Factors Influencing Fast-Food Consumption Among Students at Universiti Malaysia Kelantan, City Campus**

**Nur Amiera Adila binti Mohd Rozaman, Nur Amisya Farhah binti Muhamad  
Hatta, Nur Hani Balqis binti Mohd Rafi, Widad binti Muhammad Suffian &  
\*Nursalihah Binti Ahmad Raston**

*Faculty of Hospitality, Tourism and Wellness, Universiti Malaysia Kelantan  
Corresponding email: [nursalihah.ar@umk.edu.my](mailto:nursalihah.ar@umk.edu.my)*

---

## **ABSTRACT**

The study aims to identify the factors that affect fast food consumption among students at the Universiti Malaysia Kelantan, City Campus. The primary goal of the researcher in this study is to identify the characteristics that influence fast food consumption among students at Universiti Malaysia Kelantan, City Campus, which is becoming more prevalent over time. Therefore, the study aims to investigate the factors that affect fast food consumption among students at Universiti Malaysia Kelantan, City Campus. There are four research objectives discussed. To examine the effect of time management, financial factors, knowledge about fast food impacts and physical activities on fast-food consumption among students in Universiti Malaysia Kelantan, City Campus. The study was conducted using a quantitative research approach which is through online questionnaire to collect the data. There were 364 respondents participated in the study which had been conducted through social media like WhatsApp and it focused on the all three faculties in City Campus.

**Keywords: Fast Food, Time, Financial, Knowledge, Physical**

---

## **INTRODUCTION**

Fast food is characterized as hot, easily prepared, or already cooked food, such as hamburgers, served in restaurants within a short time (Dictionary C. Fast Food, 2020). The world has adopted the fast-food culture thanks in part to the fast-food sector. Fast food establishments and vendors have expanded in industrialized and developing countries despite rising awareness of the negative health impacts of a diet rich in fat, salt, and sugar. Even though the adverse health effects of a diet high in fat, salt, and sugar are becoming more widely known, the number of fast-food restaurants and dealers has increased in both developed and developing countries. Due to rapid economic development, urbanization, and the influence of Western cultures, Malaysians' lifestyles have undergone tremendous change during the past three decades. The 1980s witnessed the first observable shifts in food patterns as a result of Malaysia's rapid economic expansion and changes in employment tendencies (Noor MI, 2002). As a result, the fast-food business saw significant expansion in the 1990s (Soon JM and Tee ES, 2014). According to the Department of Statistics Malaysia, there were 1621 fast food restaurants in Malaysia in 2010 and 2597 in 2015 (Department of Statistics Malaysia, 2017).

Teenagers who consume unhealthy diets, such as those high in energy-dense foods and low in fruits and milk, are more likely to frequently eat fast food (Sebastian RS and Enns CW, et al., 2009). Since dietary habits formed during adolescence may last throughout adulthood, poor eating habits in adolescents can result in excessive weight gain and raise the risk of obesity. According to previous research from other nations, fast food consumption is more common among younger people, households with higher incomes, adults with higher body mass index (BMI), and men (Mohr P and Wilson C,

et al., 2007). Between 2004 and 2009, the proportion of Chinese adolescents aged 13 to 17 who reported eating fast food rose quickly from 17.9 to 26.3% (Xue H and Wu Y, et al., 2016). Investigating fast food consumption patterns among teenagers in Malaysia would therefore be intriguing. Therefore, the main focus of this study is to find out the factors that affect fast-food consumption among students in Universiti Malaysia Kelantan (UMK), City Campus. There were three objectives of this research:

1. To examine the influence of time management on fast food consumption among students in Universiti Malaysia Kelantan, City Campus.
2. To examine the influence of financial factors on fast food consumption among students in Universiti Malaysia Kelantan, City Campus.
3. To examine the influence of knowledge about fast food impacts on fast-food consumption among students in Universiti Malaysia Kelantan, City Campus.
4. To examine the influence of physical activities on fast food consumption among students in Universiti Malaysia Kelantan, City Campus.

## **SIGNIFICANCE OF THE STUDY**

Following the topic chosen, researchers have looked into the relationships between independent and dependent variables, such as time management, financial factors, knowledge about fast food impacts, and physical activity. A fast-food consumption solution would benefit many people, including future researchers, students at Universiti Malaysia Kelantan, City Campus and others.

## **LITERATURE REVIEW**

### **Time Management**

Fast food consumption has a history of having negative consequences on dietary intake and overall health. Fast food is most frequently consumed by those in their twenties, probably because these meals are convenient, quick, and reasonably priced (Seo HS et al.,2011). In a Pusan study by Lee, 40.5% of high school students and 38.5% of primary school students reported eating fast food once or twice per month, which is greater than the percentage seen in people in their forties or fifties (Lee JS.,2007). Fast-food consumption among students is a result of poor time management. According to Bipasha and Goon's 2014 research, 54% of students at a private university in Bangladesh skipped breakfast due to time constraints and commitments to classes, as well as the variety of food available at a fast-food restaurant. Due to time restrictions, many students had switched from eating home-cooked or healthy meals to fast food to fit everything into their busy schedules. As a result, when they are hungry, they eat fast food to satisfy their need. To simplify, living as a student is not easy. For example, due to the tight schedule of lectures and assignments, students choose to eat on the go rather than eat clean, simply choosing for fast-food because it is more convenient and can save more time (De AP et al.,2015).

The way our brains are wired causes some people to be frequently labelled as lazy, according to researchers who have shown that inactivity is a natural tendency of the brain. Even though we all possess this mentality of laziness, only the individual may



decide whether or not they are lazy. Most college students who enjoy fast food do so because of laziness and a desire to save time. Fast food is everything quick, tasty, handy, and trendy. People, primarily students, become addicted to fast food due to clever snack advertising and the appeal of convenience and taste. Potato wafers and Cheetos are food that does not require cooking or heating. Not only that, but people also enjoy eating pizza and hamburgers while watching TV or doing their homework because it saves them a tremendous amount of stress and time when they are short of time. The only thing left to do is wait for these meals to be made and delivered to their door while still hot and ready to eat (Bhaskar et al.,2012). As a result, efficient time management is essential in everyday life because it allows people to do more in less time and feel calmer and less stressed over time.

### **Financial Factors**

Customers' perceptions of the pricing and quality of a product or service will significantly impact a company's bottom line. Customer-perceived value is the expectation that a customer can purchase with confidence. It is the emotion purchasers should have had after purchasing something of high value. As a result, customers will be proud to associate with a company with a quality image. Furthermore, it has a broader scope of applicability than ensuring product or service quality. It's also a means to keep track of corporate procedures and ensure that customer satisfaction is always excellent, both internally and externally. It is to provide the highest level of client happiness.

Fast-food restaurants have chosen to focus on providing high-quality products at low prices. They believe that excellent quality comes from the best fresh ingredients, and excellent quality comes from the best ingredients. Additionally, fast-food chains collaborate closely with the Malaysian government to assemble specialists from across the globe in order to identify the most successful and modern programmes and policies to guarantee that food safety requirements are not compromised. Additionally, the fast-food restaurant offers reasonably priced, excellent lunch and supper sets, which is quite popular with Malaysian customers, especially teens who place a high value on getting the best deal.

### **Knowledge about Fast Food Impacts**

A well-known microbiologist named Dr. Michael F. Jacobson invented "Junk Food" in 1972 to describe unhealthy or un-nutritious food. Junk food must contain various ingredients, some of which can be unhealthy. For instance, Monosodium glutamate (MSG), a flavour enhancer frequently added to processed meats, canned vegetables, soups, and Chinese food, causes hypothyroidism, headaches, nausea, weakness, difficulty breathing, drowsiness, and rapid heartbeat.

Fast-food restaurants and other stores are regular destinations for teenagers after school. Allowing a youngster to study information about junk food is the best way to convince them to eat healthier foods. Children can learn much about junk food from websites, schools, magazines, and other sources. Parents that provide their kids access to such information encourage their kids to adopt healthier eating practices by raising awareness of the issue.

### **Physical Activities**

Living on the marcapada involves many responsibilities that must be fulfilled and take up a person's time, making simple tasks like eating and drinking increasingly challenging. Since eating fast food regularly makes it easier for us to engage in daily physical activities, we neglect to take nutrition seriously since we are too busy chasing our objectives or life ambitions. The health benefits of exercise cannot be overstated. White-collar occupations and modern life's amenities make us more sedentary, which is terrible for our health.

Additionally, physical activity covers any bodily motions that require energy in daily life, such as brisk walking, jogging, and running. A person will reportedly feel better after engaging in physical activity because endorphin, the happy hormone, and the stress hormone will be created more, increasing both the body's function and social activity since physical activity is typically more enjoyable when done in groups or pairs. Burgers and instant noodles are examples of fast food that have been processed and contain many chemicals that can improve nutrition and extend the shelf life of the item. The key factor contributing to the drawbacks of eating fast food frequently is the food's composition.

Consuming fast food affects physical activity, such as can reduce a person's productivity. For example, university students who often eat instant noodles to save on daily expenses will face a recession in their daily activities due to a lack of energy and nutrients. The students should give priority to themselves so that they have good skills and are convincing. Therefore, a balanced and healthy diet can guarantee the effectiveness of students in class and also the ability to do physical activities in healthy conditions. Furthermore, food delivery applications that are growing today also make our people even lazier if viewed from a negative angle. The bottom line is that technological convenience and economic turmoil must be faced wisely to gain positive and profitable benefits.

### **Fast-food Consumption**

According to research, college is a crucial time for students to change their eating habits unhealthily. University students are also more likely to have a lousy diet intake (Von Ah D and Ebert S, et al. 2004). Students who first enroll in college frequently experience the strains of shifting academic burdens, attempting to adapt to their new environment, building networks, and taking on unexpected obligations. University students today have more flexibility and control over their lives than ever before, which can lead to poor nutritional decisions like a regular fast-food diet (Ngamvitroj A and Park N et al., 2004).

The fast-food culture among students may cause a demographic shift away from traditional foods and home-cooked meals. These nutritional transition patterns in the population are linked to a decline in diet quality and the loss of cultural traditions and family customs (Zaghloul S and Al-Hooti SN et al., 2013).

The reasons college students eat at fast-food outlets have not been the subject of much research. Advertising and media, lack of parental supervision, taste preferences, self-control, time constraints, and the physical environment - such as availability and accessibility, costs, and decent menu options - can all have an impact on food choices. Including options in fast-food orders could improve the quality of their diet since some menu selections in fast-food places offer fruits and vegetables (Tom Deliens and Clarys P, et al., 2014).

The term "fast food" was used to describe meals that are prepared rapidly, offer takeaway options, have little to no wait staff, and demand payment before being delivered (Block J and Scribner R, et al., 2004).

### Research Hypothesis

The literature analysis showed that factors influencing fast-food consumption among students in Universiti Malaysia Kelantan, City Campus, include time management, financial factors, knowledge about fast food impacts, and physical activity. As a result, the study intended to look at the relative importance of these variables. The study's hypotheses were outlined as follows:

**H<sub>1</sub>:** There is a significant influence of time management on fast-food consumption among students at Universiti Malaysia Kelantan, City Campus.

**H<sub>2</sub>:** There is a significant influence of financial factors on fast-food consumption among students at Universiti Malaysia Kelantan, City Campus.

**H<sub>3</sub>:** There is a significant influence of knowledge about fast-food impacts on fast-food consumption among students at Universiti Malaysia Kelantan, City Campus.

**H<sub>4</sub>:** There is a significant influence of physical activities on fast-food consumption among students at Universiti Malaysia Kelantan, City Campus.

### Research Framework

The Figure 1 below shows the research framework use for this study:

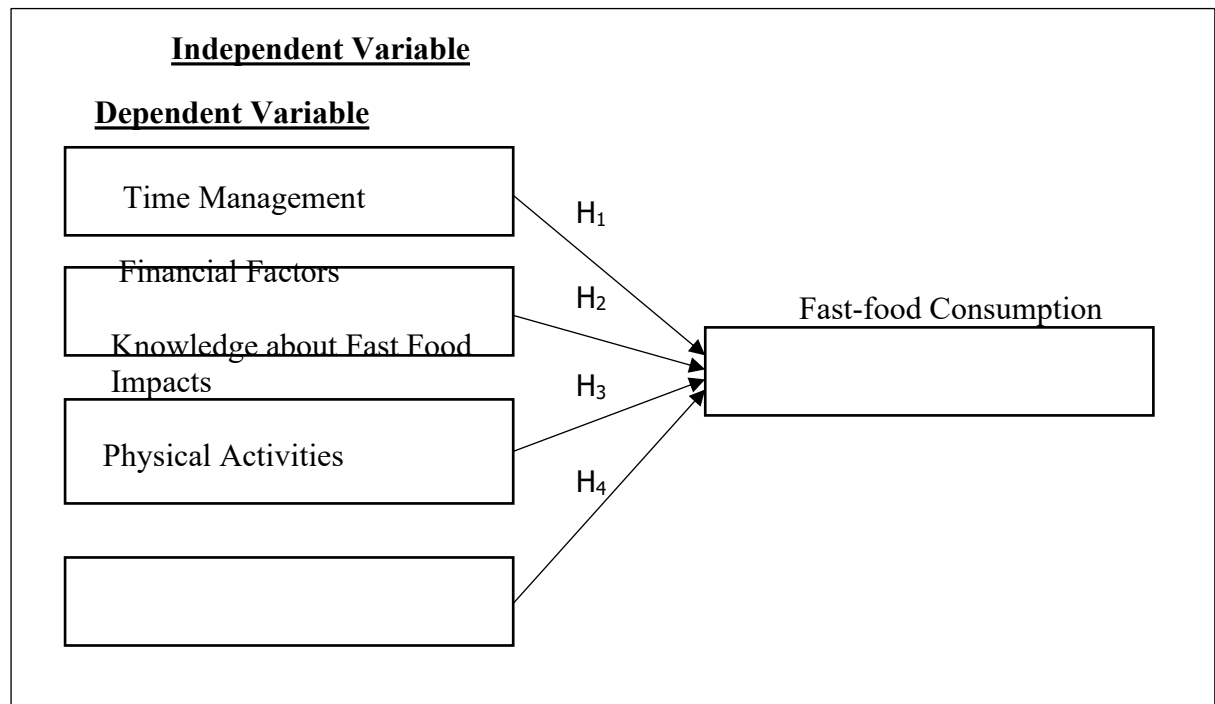

## **METHODOLOGY**

### **Research Design**

The goal and intent of research design are to make sure that the data obtained enables researchers to solve the study challenge at hand correctly. An interpretative methodology known as research design can be regarded as the best approach for the investigation. The questionnaires utilized in this study's examination structure follow a quantitative methodology, and all of the information collected from respondents will be used as the study's primary data. Through this examination framework, which includes setting up and organizing a research strategy, the material acquired will assist an analyst in understanding the relationship between independent and dependent variables. The quantitative data acquired by the survey is used in this assessment technique. The survey includes age, gender, study profile, ethnicity, year of study, and other factors. The four components of the questionnaires—A, B, C, and D—are related to demographic variables, dependent variables, and independent variables. 364 students from Universiti Malaysia Kelantan, City Campus will be among the approximately 364 respondents whose responses will be chosen for this study.

### **Data Collection**

One form of data gathering approach is primary data, which is collected expressly for the design aspect. It is the raw data gathered during the study procedure. It's also a secure data collection system because researchers know where the information came from and was compiled by researchers. To contain data for this study, researchers engaged the questionnaire approach. Questionnaires were chosen because, compared to other methods, they can provide quicker responses from a more significant number of respondents, providing more accurate and reliable results for the entire research project. The questionnaire was administered online, allowing respondents to respond quickly. It will give convenience to the respondents and bring them to answer the questionnaire without any strain and also be suitable to give honest and accurate information.

A quick and inexpensive method to obtain information from moving sources is to use secondary data, often known as data analysis. This type of data analysis is much more cost-effective in conducting research projects. It is also a wise approach to initiate research using secondary data to help design research projects. Journals from academic handbooks and databases like Google Scholar were used as secondary data in this study.

### **Sampling**

Researchers will use probability sampling in this study. Since each respondent has an equal chance of being chosen, researchers will utilize simple random sampling to choose several respondents from each population. Students from the Universiti Malaysia Kelantan, City Campus, were chosen as respondents. The total number of respondents is 364 students who were chosen to answer the questions to help researchers collect data regarding the research topic being researched. The reason why researchers chose students in Universiti Malaysia Kelantan, City Campus as respondents is that they are also individuals who are closely related to the consumption of fast food throughout being a student.

## Data Analysis

The key information used in the research effort is described in this section. Additionally, this section makes an effort to discuss the research hypotheses and address the objectives of the study. This chapter includes tables, pies, and charts that display the data evaluation, statistical analysis findings, and all of the research study's conclusions. The reliability test, Pearson Correlation, and descriptive statistics are the main analyses used in this research study.

The data from the questionnaire was structured, edited, categorized, and coded by the researcher using computer tools such as the Statistical Package for the Social Sciences (SPSS). This tool aids researchers in quickly calculating information and inspires quantitative investigations that are faster and less demanding. Using a variety of statistical techniques, this study assesses descriptive analysis, reliability analysis, and Pearson's correlation coefficient. Researchers can make use of data sources to evaluate the logical conclusions reached by this computer programme.

To examine the variables and explain the respondents' biographical information, descriptive analysis was performed. The importance of the link between the variables in the study was determined using reliability statistics, while Pearson's Correlation Coefficient was used to evaluate the independent variable and analyze the data (Bewick et al., 2003).

## FINDINGS

Results of Frequency Analysis.

Table 1 shows the result of frequency analysis of respondents.

Table 1: Frequency Analysis

No	Socio-Demographic Characteristics	Frequency (n)	Percentage (%)
1	Gender	364	100
	Male	74	20.3
	Female	290	79.7
2	Age	364	100
	18 years	3	8
	20 years	7	1.9
	21 years	19	5.2
	22 years	86	23.6
	23 years	218	59.9

	24 years	21	5.8
	25 years	4	1.1
	26 years	2	0.5
	33 years	2	0.5
	37 years	1	0.3
	39 years	1	0.3
<b>3</b>	Race	364	100
	Malay	324	89
	Chinese	15	4.1
	Indian	19	5.2
	Iban	2	0.5
	Bajau	1	0.3
	Sabah	3	0.8
<b>4</b>	Religion	364	100
	Islam	330	90.7
	Christian	5	1.4
	Buddha	10	2.7
	Hindu	19	5.2
<b>5</b>	Education Level	364	100
	Sijil Pelajaran Malaysia	6	1.6
	Diploma	21	5.8
	Ijazah Sarjana Muda	337	92.6
<b>6</b>	Year of Study	364	100
	Year 1	20	5.5
	Year 2	48	13.2
	Year 3	276	75.8
	Year 4	20	5.5
<b>7</b>	Faculty	364	100
	FHPK	264	72.5

FKP	71	19.5
FPV	29	8

Table above shows the result of frequency analysis of respondents. The research focuses on students in Universiti Malaysia Kelantan, City Campus and most of the respondents were female which is 290 respondents (79.7%) while the male are 74 respondents (20.3%).

On the other hand, majority of the respondents were from age 23 years which is 218 respondents (59.9%), followed by age 22 years which is 86 respondents (23.6%), 24 years as many as 21 respondents (5.2%) then, 21 years which is 19 respondents (5.2%), 20 years as many as seven respondents (1.9%), 25 years which is four respondents (1.1%), 18 years as many as three respondents (8%), 26 and 33 years both two respondents (0.5%) and lastly 37 and 39 years both one respondent (0.3%).

Furthermore, most of the respondents are Malay which is 324 respondents (89%) followed by Indian as many as 19 respondents (5.2%) and Chinese 15 respondents (4.1%). Bumiputera Sabah race consists three respondents (0.8%), Iban have two respondents (0.5%) and one respondent from Bajau race (0.3%). For religion, most of the respondents are Islam which are 330 respondents (90.7%) then, Hindu as many as 19 respondents (5.2%) followed by Buddha which is 10 respondents (2.7%) and lastly Christian consists five respondents (1.4%).

Last but not least, majority of the respondent have education level in Ijazah Sarjana Muda 337 respondents (92.6%), 21 respondents have Diploma (5.8%) and six respondents have education level in Sijil Pelajaran Malaysia (1.6%). For year of study, majority of the respondents are from Year 3 students which are 264 respondents (72.5%) followed by Year 2 as many as 48 respondents (13.2%), then respondents from Year 1 and Year 4 both consists 20 respondents (5.5%). Finally, respondents from FHPK faculty have the most respondents which are 264 respondents (72.5%) followed by FKP which is 71 respondents (19.5%) and FPV consist 29 respondents (8%).

## Result of Descriptive Analysis

Table 2 shows the result of descriptive analysis of variable.

Table 2: Descriptive Analysis

Variable	Items	Mean Score	Standard Deviation
<b>Fast-food Consumption</b>	Fast food tastes good.	4.22	0.792
	I get good value for money when I buy a fast food 'packaged meal deal'	3.72	0.867
	I feel satisfied after eating fast food.	3.87	0.977
	I am able to treat/reward myself with fast food.	3.74	0.913
	Eating fast food frequently saves my time.	3.54	1.045
	Eating fast food frequently is good for my health	2.02	1.056
	Eating fast food frequently encourages an inactive lifestyle.	4.41	0.862

	Eating fast food frequently is very convenient for me.	3.41	1.018
<b>Time Management</b>	I am too busy to eat healthy food.	2.78	1.150
	I am too rushed in the morning to eat a healthy breakfast.	3.18	1.178
	I don't have time to think about eating healthy.	2.66	1.137
	Eating healthy meals just takes too much time.	2.62	1.085
	It is hard to find time to sit down and eat a meal.	2.76	1.228
	I tend to 'eat and run'.	2.13	1.143
	Regular meals are important to me.	3.82	0.842
	I eat meals at about the same time every day.	2.90	0.995
<b>Financial Factors</b>	I feel fast food is cheaper than regular meals.	3.39	1.051
	The last fast-food meal I had was worth the price.	3.57	0.886
	My purchasing habit ever been influenced by promotions of fast-food chains on social media.	3.72	0.932
	I always use discount coupons to buy fast food.	3.38	1.109
	I think it is convenient to buy a meal in fast food restaurant.	3.54	0.936
	I prefer fast food over any other meal.	2.92	1.090
	I often consume fast food on a weekly basis.	2.64	1.210
	On average, I think more money is spent on regular meals than fast food per week.	3.51	1.087
<b>Knowledge about Fast Food Impacts</b>	I think fast food is not good for health.	4.46	0.814
	I think fast food can provide all vital nutrients	2.31	1.060
	I think fast food has a lot of salt.	4.12	0.756
	I think fast food has a lot of fat.	4.07	0.759
	I think that consuming fast food will make me fat.	4.10	0.893
	For me, eating fast food frequently is likely to result in weight gain.	4.29	0.900
	I believe that consuming fast food too often can lead to obesity.	4.35	0.844
	I think fast food has a lot of calories.	4.39	0.793
<b>Physical Factors</b>	Consuming fast food causes physical activity to be impaired.	3.92	0.872
	I do exercise three times a week.	3.27	0.976
	Physical activity can reduce chronic diseases.	4.27	0.669
	I work out and exercise to keep myself healthy	4.26	0.839
	Eating fast food can reduce my ability to do physical activity.	3.66	0.909
	I realize that physical activity is important in everyday life.	4.48	0.694
	Eating fast food can harm your health.	4.26	0.715
	Physical activity can control us from consuming fast food.	3.93	0.817



### Result of Reliability Test

Table 3 shows the result of reliability analysis based on dependent variable and independent variable.

Table 3: Reliability Test

Variable	Number of Items	Cronbach's Alpha
Fast-food Consumption	8	0.827
Time Management	8	0.762
Financial Factors	8	0.903
Knowledge about Fast Food Impacts	8	0.758
Physical Activities	8	0.609

### Results of Pearson Correlation Analysis

Table 4 shows the result of Pearson Correlation Analysis based on the hypothesis

Table 4: Pearson Correlation Analysis

Predictors	Pearson Correlation	P-Value
Time Management	.662**	.000
Financial Factors	.694**	.000
Knowledge about Fast Food Impacts	.151**	.004
Physical Activities	.089	.089

Table 4 shows the result of Pearson Correlation Analysis in order to see the relationship of each predictor with fast-food consumption. According to the results, the null hypothesis is rejected and the alternative hypothesis is accepted for time management, financial factors and knowledge about fast food impacts while for physical activities, the null hypothesis is accepted and the alternative hypothesis is rejected. The Pearson Correlation indicates strong relationship between the fast-food consumption with time management and financial factors. Meanwhile, The Pearson Correlation indicates very weak relationship between the fast-food consumption with knowledge about fast food impacts and physical activities.

Table 5: Multiple Linear Regression Analysis

R	R Square	ANOVA	
		F	P-Value
0.765	0.585	126.299	0.000

In multiple linear regression analysis, the interpretation based on R-square and result of ANOVA. All predictors variable explained 58.5% of the total variation in fast-food consumption. Based on result of ANOVA, the study indicates that the model is significant since F value (126.299) is associated with a p-value of  $0.000 < 0.05$  and its obtain that the model fit the data well.

Table 6: Hypothesis Testing

Hypothesis	Coefficients	P-Value	Result (Supported/ Not Supported)
<b>H<sub>1</sub>: There is a significant influence of time management on fast-food consumption among students at Universiti Malaysia Kelantan, City Campus.</b>	0.315	0.000	H <sub>1</sub> is supported
<b>H<sub>2</sub>: There is a significant influence of financial factors on fast-food consumption among students at Universiti Malaysia Kelantan, City Campus.</b>	0.403	0.000	H <sub>2</sub> is supported
<b>H<sub>3</sub>: There is a significant influence of knowledge about fast-food impacts on fast-food consumption among students at Universiti Malaysia Kelantan, City Campus.</b>	0.080	0.101	H <sub>3</sub> is not supported
<b>H<sub>4</sub>: There is a significant influence of physical activities on fast-food consumption among students at Universiti Malaysia Kelantan, City Campus.</b>	0.074	0.161	H <sub>4</sub> is not supported

Based on multiple regression analysis by using enter method, the study obtained that the significant influencing factors on fast-food consumption are time management (p-value < 0.05) and financial factors (p-value < 0.05). While, there is no significant influence of knowledge about fast-food and physical activities on eating habits among students since p-value > 0.05.

## DISCUSSION AND RECOMMENDATION

In hypothesis testing, probability values, also known as p-values, are used to indicate whether an alternative hypothesis is accepted or rejected. If the p value is equal to or less than the significance level or alpha value ( $\alpha$ ), the alternative hypothesis is accepted and the test is significant. Because each hypothesis has been investigated at 95%, the null hypothesis will be rejected if the p-value is equal to or less than 0.05. In other words, there is a significant relationship between variable and non-variable variables. If the p value is greater than 0.05, the alternative hypothesis is rejected. The test was not significant because there was no discernible difference between the transformed and untransformed variables.

The purpose of the discussion is to clarify the relationship between fast food consumption and time management, financial factors, food knowledge, and physical activity among students at Universiti Malaysia Kelantan, City Campus. The data show that there is a significant relationship between the independent variables of time management, financial factors, food knowledge, physical activity, and the dependent variable of fast-food consumption. The previous study also found a significant relationship between fast food consumption and time management, financial factors, food knowledge, and physical activity.

According to the Pearson correlation value, the financial factor has a stronger correlation than time management, food knowledge, and physical activity, while physical activity has the weakest correlation, as shown by a correlation of (0.903>0.762>0.758>0.609).

The researcher will suggest some recommendations that will help for future research. This is to ensure future research gets better results and quality research. First and foremost is to expand the target demographic in future studies to include wellness students in year two and four. This would help provide the best results. This is due to the fact that the students are already educated on nutrition, knowledge about fast-food impacts, and the effect of physical activities on fast-food consumption. Future studies may benefit from it in order to get more effective results.

Furthermore, the researchers respond to the questionnaires using a range of survey approaches. For instance, the researchers can employ telephone surveys and in-person personal interviews to get the fastest response from the respondents. If the respondents have any difficulties comprehending the study, they will find it easy to ask questions and get prompt responses via personal interviews and telephone surveys. If various surveying techniques are applied, the results will also be more accurate and valuable.

Last but not least, multilingual questionnaires that cover languages like Mandarin and Tamil should also be used in future studies. This is due to the fact that the questionnaire's primary languages were simply English and Malay. The questionnaire's multilingual capacity may make it simpler to understand and less stressful to respond for respondents with different ethnic and linguistic origins. As a result, the outcomes will be more reliable and effective. The use of different languages is therefore highly beneficial for providing accurate answers to the inquiry.

By following these recommendations, future research on fast-food consumption among students can provide a more comprehensive understanding of the factors that influence this behaviour. This information can then be used to develop more effective interventions to help students make healthier food choices.

## **CONCLUSION**

The research is about factors that affect fast-food consumption among students in Universiti Malaysia Kelantan, City Campus. Time management, financial factors, knowledge about fast food impacts and physical activities are independent variables. These variables influence the dependent variable which is fast-food consumption. There was a significant relationship between the three independent variables and the dependent variable.

This research was limited due to lack of interest in the questionnaire, lack of understanding and also having problems gaining access to FKP and FPV students at Universiti Malaysia Kelantan, City Campus. The proposed study, which includes expanding the target population, using more survey methods and using multiple languages, will be useful in future research.

## **REFERENCES**

- Abraham, Samuel & Martinez, Manuel & Salas, Gabriela & Smith, Jessica. (2018). College students' perception of risk factors related to fast food consumption and their eating habits. *Journal of Nutrition and Human Health*. 02. 10.35841/nutrition-human-health.2.1.18-21.

- Akter, M., Sadekin, M. N., & Patwary, A. K. (2020). An Empirical Study on Students' Satisfaction from Mawlana Bhashani Science & Technology University, Bangladesh. *Review of Economics and Development Studies*, 6(2), 363-379.
- Al Mahmud, S. R. (2020). The effectiveness of Facebook advertisements on purchase intention of customers in Malaysia. *South Asian Journal of Social Sciences and Humanities*, 1(1), 97-104.
- Alkazemi, D., & Shaban, L. (2019). Trends in fast-food consumption among Kuwaiti youth. *International Journal of Preventive Medicine*, 10(1), 44. [https://doi.org/10.4103/ijpvm.ijpvm\\_480\\_18](https://doi.org/10.4103/ijpvm.ijpvm_480_18)
- Alom, S., Patwary, A. K., & Khan, M. M. H. (2019). Factors affecting the turnover intention of Bangladeshi migrants in the United Arab Emirates: An empirical study on the hotel industry. *International Journal of Innovation, Creativity and Change*, 8(3), 344-360.
- Ashakiran, D. R., & Deepthi, R. (2012). Fast foods and their impact on health. *Journal of Krishna Institute of Medical Sciences University*, 1(2), 7-15.
- Bipasha, M. S., & Goon, S. (2014). Fast food preferences and food habits among students of private universities in Bangladesh. *South East Asia Journal of Public Health*, 3(1), 61–64. <https://doi.org/10.3329/seajph.v3i1.17713>
- Didarloo, A., Khalili, S., Aghapour, A. A., Moghaddam-Tabrizi, F., & Mousavi, S. M. (2022). Determining intention, fast food consumption and their related factors among university students by using a behavior change theory. *BMC public health*, 22(1), 314. <https://doi.org/10.1186/s12889-022-12696-x>
- Dingman, D. A., Schulz, M. R., Wyrick, D. L., Bibeau, D. L., & Gupta, S. N. (2014). Factors related to the number of fast food meals obtained by college meal plan students. *Journal of American college health: J of ACH*, 62(8), 562–569. <https://doi.org/10.1080/07448481.2014.945456>
- Dowarah, L. J. (2020, August 25). *Fast Food Consumption Behaviour among College Students- A Case Study in Tinsukia*. <https://www.foodandnutritionjournal.org/volume8number2/fast-food-consumption-behaviour-among-college-students-a-case-study-in-tinsukia/>
- Fengmin, Z., Baijun, W., Jiangtao, B., Li, L., & Patwary, A. K. (2022). Investigating revisit intention of medical tourists in China through nutritional knowledge, perceived medical quality, and trust in the physiologist: A recommendation on health tourism policy measures. *Frontiers in Public Health*, 10, 893497.
- Hazbar, A. M. H., Alem Mohammed, A., & Karim, A. K. A. (2019). An Empirical Study of Factors Influencing hotel customers' online booking Intention. *مجلة العلوم التربوية و الدراسات الإنسانية*, (5), 1-17.
- Imtiyaz, S. (n.d.). *KAJIAN: TAHAP PENGETAHUAN MENGENAI KESAN PENGAMBILAN MAKANAN*. [prezi.com. https://prezi.com/r5j0efccsc8x/kajian-tahap-pengetahuan-mengenai-kesan-pengambilan-makanan/?frame=888a6ff894e2f7331ed44ba6390f052e0fe9a0f5](https://prezi.com/r5j0efccsc8x/kajian-tahap-pengetahuan-mengenai-kesan-pengambilan-makanan/?frame=888a6ff894e2f7331ed44ba6390f052e0fe9a0f5)
- Just a moment. (n.d.-f). [https://www.researchgate.net/publication/289556509\\_Factors\\_Influencing\\_Fast-Food\\_Consumption\\_Among\\_Adolescents\\_in\\_Tehran\\_A\\_Qualitative\\_Study](https://www.researchgate.net/publication/289556509_Factors_Influencing_Fast-Food_Consumption_Among_Adolescents_in_Tehran_A_Qualitative_Study)
- Lee, J. S. (2007). A comparative study on fast food consumption patterns classified by age in Busan. *Korean journal of community nutrition*, 12(5), 534-544.

- Li, L., Ragavan, N. A., Patwary, A. K., & Baijun, W. (2022). Measuring patients' satisfaction toward health tourism in Malaysia through hospital environment, nutritional advice, and perceived value: A study on Chinese exchange students. *Frontiers in public health*, 10, 893439.
- Li, L., Wu, B., & Patwary, A. K. (2022). How marine tourism promote financial development in sustainable economy: new evidences from South Asia and implications to future tourism students. *Environmental Science and Pollution Research*, 29, 1155-1172.
- Li, L., Wu, B., & Patwary, A. K. (2022). The psychosocial factors affecting chinese Outbound Exchange and mobility students' academic performance during COVID-19. *Frontiers in psychology*, 13, 872516.
- NCBI - WWW Error Blocked Diagnostic. (n.d.). <https://www.ncbi.nlm.nih.gov/pmc/articles/PMC6196377/>
- Patwary, A. K., Roy, B., Hoque, R., & Khandakar, M. S. A. (2019). Process of developing a community based tourism and identifying its economic and social impacts: An Empirical study on Cox's Bazar, Bangladesh. *Pakistan Journal of Humanities and Social Sciences*, 7(1), 1-13.
- Quoquab, F., & Dardak, R. Abu. (2011, January). *Consumers' preference and consumption towards fast food: Evidence from Malaysia*. ResearchGate. [https://www.researchgate.net/publication/277076342\\_Consumers'\\_preference\\_and\\_consumption\\_towards\\_fast\\_food\\_Evidence\\_from\\_Malaysia](https://www.researchgate.net/publication/277076342_Consumers'_preference_and_consumption_towards_fast_food_Evidence_from_Malaysia)
- Seo, H. S., Lee, S. K., & Nam, S. (2011). Factors influencing fast food consumption behaviors of middle-school students in Seoul: an application of theory of planned behaviors. *Nutrition research and practice*, 5(2), 169-178.
- Simy, S., Susan, S., Thomas, S., Umarani, & Shetty, A. (n.d.). *Adolescents' knowledge regarding the effects of fast food on health*. Adolescents' Knowledge Regarding the Effects of fast food on Health. Retrieved March 2016, from [https://www.researchgate.net/publication/308154628\\_Adolescents'\\_Knowledge\\_Regarding\\_the\\_Effects\\_of\\_fast\\_food\\_on\\_Health](https://www.researchgate.net/publication/308154628_Adolescents'_Knowledge_Regarding_the_Effects_of_fast_food_on_Health)
- Sumethokula, P., Patwary, A. K., Srinuanpanc, B., Srinuanpand, C., Suwandee, P., Thammathikulf, A., & Phanong, W. (2020). The potential of new tour repackaging for creative tourism among entrepreneurs in Nakhon Si Thammarat. *International Journal of Innovation, Creativity and Change*, 13(10), 1752-1771.
- Wu, B., Liu, S., Wang, J., Tahir, S., & Patwary, A. K. (2021). Assessing the mechanism of energy efficiency and energy poverty alleviation based on environmental regulation policy measures. *Environmental Science and Pollution Research*, 28, 40858-40870.
- Wu, B., Zhai, B., Mu, H., Peng, X., Wang, C., & Patwary, A. K. (2021). Evaluating an economic application of renewable generated hydrogen: A way forward for green economic performance and policy measures. *Environmental Science and Pollution Research*, 1-15.

# Factors Influencing Eating Habits among Wellness Students at Universiti Malaysia Kelantan

*Anis Farhana Binti Mohd Sa'auzi, Fasha Nur Athilah Binti Che Hussin,  
Nurliyana Binti Anuar, Muhammad Idham Bin Abdul Jalil & \*Nursalihah Binti  
Ahmad Raston*

*Faculty of Hospitality, Tourism and Wellness, University Malaysia Kelantan  
Corresponding email: [nursalihah.ar@umk.edu.my](mailto:nursalihah.ar@umk.edu.my)*

---

## ABSTRACT

Nowadays a person's eating habits are influenced by a number of specific factors. It can happen either in positive or negative and problems occur if eating habits are not taken care of properly and bring harm to an individual. The study aims to investigate the factors that influence the eating habits among third year of Wellness students at Universiti Malaysia Kelantan (UMK). A total of 123 respondents from third year Wellness students were surveyed based on a quantitative research design using questionnaire. The study performs the Pearson correlation analysis to see the relationships among variables and modeled the Multiple Linear Regression (MLR) to test the hypothesis in order to find the factors that influence the eating habits. The study found that physical factor ( $r = 0.472$ ), psychological factor ( $r = 0.567$ ) and food consumption trend ( $r = 0.624$ ) have moderate positive significant relationship with eating habits since all the p-value is less than 0.05. However, results of MLR obtain that only two variables were significant influences on eating habits which are psychological ( $p\text{-value} < 0.05$ ) and food consumption trend ( $p\text{-value} < 0.05$ ). While, there is no significant influence of physical factors on eating habits among third year Wellness students at UMK ( $p\text{-value} > 0.05$ ). Factor that most influence eating habits is food consumption trend ( $B = 0.338$ ). The implication of the study is to make the community aware of the importance of maintaining healthy eating habits and to adopt healthy eating habits regardless of the circumstances. Healthy eating habits can prevent chronic diseases.

**Keywords: Eating Habits, Physical Factors, Psychological Factors, Food Consumption Trends.**

---

## INTRODUCTION

Eating habits have become a concern, especially among the community, especially for university students. As a university student, there is no denying that each student has their own eating habits. However, it is very important for them to adopt proper eating habits as prescribed in the nutritional guidelines. According to the Malaysian Dietary Guidelines 2020, it is important to adopt a healthy diet to ensure the body consumes sufficient protein, fat, and carbohydrates as well as all essential vitamins and minerals. The combination of all food groups in the Malaysian Pyramid 2020 can ensure that students get the necessary nutrients based on the creation of the food pyramid. Eating habits that not only affect the physical, mental and emotional but are also decisive for the future. Healthy eating habits are the selection of balanced food and aim to maintain health. A healthy or balanced diet has sufficient nutrient content such as carbohydrates, proteins, fats, vitamins, and salt. Lack of those nutrition will lead to malnutrition. Therefore, it is important for today's society to wisely choose healthy food because there are various benefits obtained when practicing it.

However, there are also irregular eating habits. According to Dr. Christy C. Tangney, a clinical nutritionist at Rush University Medical Center, studies have shown that even individuals who do not eat breakfast and consume only a few calories that

day are more likely to have a higher body mass index or BMI. Students' eating habits are also caused by their psychology (Ganasegeran et al. Nutrition Journal, 2012). Among the respondents, almost 48.5% of students eat because they feel lonely, 62.1% feel out of control when talking about food, 53.8% eat so much that it hurts stomach, 53% of students will eat because they feel uncomfortable or anxious, 59.1% will eat when they are bored and 80.3% will eat because they feel happy. Previous studies have shown that stress behavior can affect an individual's eating habits (Torres S & Nowson C, 2007; Adam T, & Epel E, 2007). Usually, people who are in a stressed society group will be more inclined to eat more as a way for them to overcome the stress (Gower B, Hand CE & Crooks ZK, 2008).

Eating habits are defined as "habitual behavior related to an individual's eating habits, choice of food eaten, preparation of food, and amount eaten". In addition, eating habits is an important aspect of life because it can affect long-term health outcomes due to unhealthy eating habits such as eating foods that lack nutrients, skipping meals and lack of nutrition. Everyone has different eating habits and it depends on themselves whether they have healthy or unhealthy eating habits. There are many factors that cause people's eating habits. The consumption of unhealthy food does not only occur among children, but it also occurs among teenagers and the elderly. The use of unhealthy food has a great impact on health, especially for people who smoke. Among the effects of eating unhealthy food are obesity, diabetes, and kidney disease. If the body is not healthy, all the activities to be done cannot be done well, for example, movement will be slow. Therefore, this study shows the factors influencing eating habits among third year Wellness students at Universiti Malaysia Kelantan. There were three objectives of this research:

1. To investigate the influence of physical factors on eating habits among third year Wellness students at Universiti Malaysia Kelantan
2. To investigate the influence of psychological factors on eating habits among third year Wellness students at Universiti Malaysia Kelantan
3. To examine the influence of food consumption trends factors on eating habits among third year Wellness students at Universiti Malaysia Kelantan

### **Significance of the Study**

#### ***University Students***

The study will help university students know and understand about healthy and balanced food selection. In addition, it will be a reference for students to know more about the factors that cause eating habits, and it will be a new experience or knowledge in daily life. The results of this study hope to identify the factors that influence eating habits among third year Wellness students at Universiti Malaysia Kelantan. In addition, eating snacks late at night and eating unhealthy food is also one of the factors that influence eating habits among Wellness students. By consuming unhealthy food, it will affect all student activities because it has a profound effect on a person's body such as losing focus while studying, quickly falling asleep and so on. Thus, this study can help students to prevent chronic diseases caused by students eating habits.

### **LITERATURE REVIEW**

#### **Physical Factors**

Physical factors can affect an individual's eating habits. This is because everyone has their own eating habits. According to (Kabir A, Miah S & Islam A, 2018) there is a relationship between an individual's physical factors and their eating habits. This physical factor includes cooking skills for an individual, taste of food, food taboo, state of mind, past food habits, knowledge about food and so on. The results of the study

show that all the physical factors have a relationship with the eating habits of an individual.

However, the eating habits taken by an individual depend on themselves whether they want to choose healthy food or unhealthy food. Taste, texture, appearance, familiarity, smell, whether the food goes with other foods and how the food is prepared as important in influencing their food choice decisions (Amanda Fitzgerald, Caroline Heary, Elizabeth Nixon & Colette Kelly, 2010). Not just that, although they have knowledge about healthy eating, young people's eating preferences, especially in terms of taste, texture, and appearance, seem to prevail over this knowledge when making food decisions.

### **Psychological Factors**

According to the study Psychological Factors are Important Correlates of Dietary Pattern in Overweight Adults which explains that adults are likely to feel depressed when they feel the demands of the environment as a burden on themselves. (Chonen, Kessler RC, Gorlon LU, 1995). This stress can cause bad things like depression and unhealthy eating habits. This can also lead to chronic diseases. (Bale TL.2006 and McEwen Bs 2005). Negative emotions are also one of the causes of changes in eating habits. Feelings of anger, fear, and sadness lead to disordered eating patterns. (Machth M, Simons G, 2000). Desire to eat foods high in fat and high in carbohydrates. This is more common in women than men. (Benton D, 2002). This shows that psychologically depressed people will have unhealthy eating habits. Stress or depression has the potential to drive a person to eat anything to get rid of the stress and depression faced. In contrast to stable emotions, where a person does not face any problems or stress in their life. They will emphasize a healthy lifestyle and balanced eating habits according to nutritional needs.

### **Food Consumption Trends Factors**

Food consumption trend factors can also influence a person's eating habits in making food choices. This is because everyone has their own habits when choosing food. According to evaluation (Zaborkis et al. BMC Public Health 2012) there is a relationship between the factors of food consumption trends of individuals and their eating habits. The percentage of daily crude consumption of fruits, vegetables and others was calculated for each survey year. Differences in food consumption rates between years of study were significant for all foods apart from university students' daily fruit consumption, some specific trends also revealed. Compared with 2010 to 2002, the percentage of girls consuming vegetables daily increased from 24.2% to 31.0%, but the percentage of boys eating vegetables decreased from 29.3% to 23.1%. in 2006, for both sexes, there was an increase in regular consumption of sweets and chocolates, cookies and cakes, and soft drinks. However, in 2006 and 2010, the consumption of crisps and fast food also decreased significantly. This shows that the food intake trend factor has a relationship with eating habits in previous studies. This relationship is believed to depend on a person's food choices, whether healthy or unhealthy.

### **Eating Habits**

The definition of "eating habits" is how a person eats. This can be considered in terms of the type of food eaten, how much and when. It is said that our eating habits affect our health. According to the Live Strong Foundation, healthy eating is consuming amounts of foods that provide the ideal balance of nutrition and energy to support children's growth and adult metabolism. Examples of healthy foods are those fortified with vitamins and minerals with less fat, cholesterol, sugar, and sodium. On the other hand, junk food or sometimes called junk food is defined as any food that is not



conducive to maintaining health. Basically, achieving healthy eating habits is as simple as controlling your food intake. More importantly, eating habits are formed very early. Therefore, taking care is essential to lead a healthy life. According to Juliet A. Boghossian, eating behavior expert and founder of food science, "you are how you eat." Here, he mentions that fast eaters tend to be ambitious, people who use their brains more than their hearts. While a slow eater tends to do whatever they want without worrying about others. Eating habits are also different in men and women. Therefore, differ in their eating habits. Finally, eating habits tend to reflect a person's attitudes and behaviors.

### Research Hypothesis

The literature review highlighted the independent variables which is physical, psychology, food consumption trend factors that influence the eating habits. Based on the literature, the hypotheses of the study are as follow:

- H<sub>1</sub>** There is a significant influence of physical factors on eating habits among third year Wellness students at Universiti Malaysia Kelantan.
- H<sub>2</sub>** There is a significant influence of psychological factors on eating habits among third year Wellness students at Universiti Malaysia Kelantan.
- H<sub>3</sub>** There is a significant influence of food consumption trend factors on eating habits among third year Wellness students at Universiti Malaysia Kelantan.

### Research Framework

Figure 1 below shows the research framework used for this study.

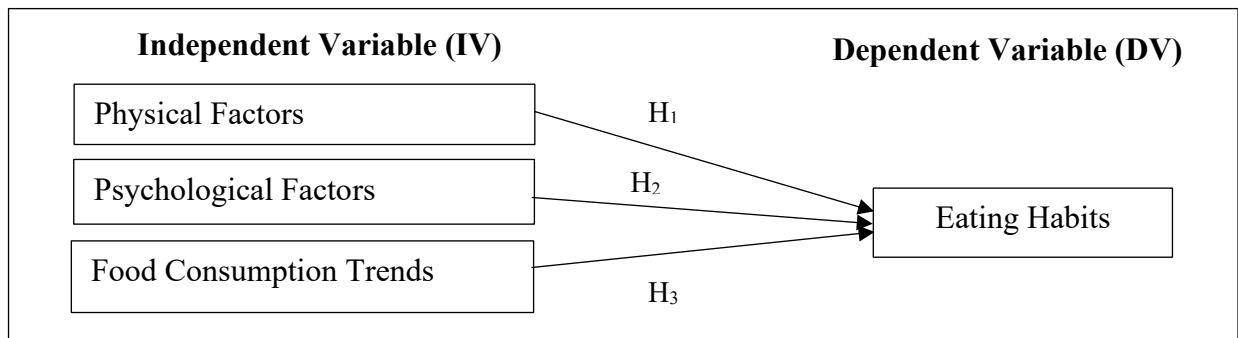

Figure 1: Research Framework

## METHODOLOGY

### Research Design

The study uses quantitative research design which involves collecting and analysing numerical data. Moreover, the quantitative research design is ideal for identifying trends and averages, making predictions, testing relationships and generalizing results for the populations. In addition, research design is one of the frameworks of research methods and techniques chosen by researchers to conduct research. Therefore, a quantitative research approach is suitable to study the factors that influence

eating habits among third year Wellness students at Universiti Malaysia Kelantan.

### **Data Collection**

The method used in collecting the quantitative data generates statistics using large-scale survey research, using methods such as internet surveys. All information obtained through the study is from primary sources which is the researcher collects data and information directly from the main source using self-administered questionnaire. Information on all Wellness students is obtained from Faculty of Hospitality, Tourism and Wellness (FHPK) office. With the data obtained, the researcher distributed the question to all respondents through a Google form provided online through their email. The questionnaire was created to find out in more detail about physical factors, physiological factors, and food consumption trends factors that influence the eating habits among third year Wellness students at Universiti Malaysia Kelantan. Internet surveys such as questionnaires became a popular method of obtaining information from the public, especially their opinions on certain issues of public interest. The internet survey also doesn't take long, and respondents are free to answer at any time.

### **Sampling**

A 123 respondents was taken from the total population which is 176 of third year Wellness students at UMK based on the Krejcie and Morgan 1970 table. The list of sampling frame was provided by the faculty. Then, the probability sampling technique which is simple random sampling using a random number generator was conducted to get the respondents. The email owners from a list of 123 numbers generated by a random number generator were respondents for the study. Furthermore, the method that has been used does not incur any costs for this research and it is not necessary to conduct the study face-to-face with the respondents.

### **Data Analysis**

Data analysis is the process of collecting, modeling, and analysing data to extract information to support decision-making. The researcher used the statistical software Statistical Package for the Social Sciences (SPSS) version 28 to analyze the data for the study. There are five types of data analysis used which are Frequency analysis, Descriptive analysis, Reliability analysis, Correlation analysis and Multiple Linear Regression analysis. The frequency analysis is used to describe respondent demographic information while Descriptive analysis is used to find out the respondent's level of agreement about the research conducted. The Reliability analysis was carried out to evaluate the survey, and the process to determine whether it provides consistent results and can be considered reliable. For the Correlation analysis, the researcher used the Pearson correlation test to measure the strength of the correlation and relationship between the independent variable (IV) and the dependent variable (DV) and carry out the Multiple Linear Regression analysis to test the hypothesis hence to determine the factors that influencing eating habits among students.

## FINDINGS

### Results of Frequency Analysis

Table 1 shows the results of the descriptive analysis for all respondents who are third-year Wellness students at Universiti Malaysia Kelantan. The majority of respondents who answered this questionnaire were female with a frequency of 111 respondents (90.2%), while only 12 male respondents (8.9%) answered this questionnaire. However, all respondents are of various ages. Most of them are 23 years old which is a total of 100 respondents (81.3%), followed by respondents who are 22 years old which is a total of 17 people (13.8%), then 5 respondents who are 24 years old (4.1%) and also a respondent who is 26 years old year that recorded 0.8%. The majority of respondents are Malays, which is 115 out of 123 respondents (93.5%) followed by 6 respondents (4.9%) who are Indians, then one respondent who is Bumiputra Sabah and also Iban who recorded a percentage of 0.8% for both races. As for religion, all the Malays adhere to the Islamic religion, which is a total of 116 respondents (94.3%), the majority of Indians are also Hindu, which is 6 people (4.9) and one respondent adheres to the Christian religion, recording a percentage of 0.8%.

As for marital status, the majority of the 123 respondents are still single. It recorded a frequency of 119 respondents (96.7%) compared to respondents who are married, which is a total of 4 respondents who recorded a percentage of 3.3%. For the subject specialization of third-year Wellness students, the majority of the respondents were from the spa track, which is 81 respondents (65.9%) while the remaining 42 respondents (34.1%) were students from the gym track. There are many answer choices for the respondents who are third year Wellness students. There are 14 respondents who live in college, who recorded a percentage value of 11.4%. The majority of respondents live in rented houses which are 89 respondents (72.4%), while the total number of respondents who live with their families is 18 respondents (14.6%), then one respondent lives in a rented room and also one respondent lives alone. Both of them recorded a percentage value of 0.8%.

Table 1: Frequency Analysis

No	Socio-Demographic Characteristics	Frequency (n)	Percentage (%)
1.	Gender	123	100
	Male	12	8.9
	Female	111	90.2
2.	Age	123	100
	22 years	17	13.8
	23 years	100	81.3
	24 years	5	4.1
	26 years	1	0.8
3.	Race	123	100
	Malay	115	93.5
	Indian	6	4.9
	Bumiputra Sabah	1	0.8
	Iban	1	0.8
4.	Religion	123	100
	Islam	116	94.3
	Christian	1	0.8
	Hindu	6	4.9

5.	Marital status	123	<b>100</b>
	Single	119	<b>96.7</b>
	Married	4	<b>3.3</b>
6.	3rd-year Wellness Subject Specialization	123	<b>100</b>
	Gym	42	<b>34.1</b>
	Spa	81	<b>65.9</b>
7.	<b>Place</b>	<b>123</b>	<b>100</b>
	<b>College</b>	<b>14</b>	<b>11.4</b>
	<b>Rent House</b>	<b>89</b>	<b>72.4</b>
	<b>With Family</b>	<b>18</b>	<b>14.6</b>
	<b>Alone</b>	<b>1</b>	<b>0.8</b>
	<b>Bilik Sewa</b>	<b>1</b>	<b>0.8</b>

## Results of Descriptive Analysis

The results in Table 4.2 show the descriptive analysis for dependent variable and independent variables. By referring to the table, it can be identified that eating habits 14 (I know that a good eating habits can prevent myself from getting many types of diseases in the future) is the highest mean value ( $M = 4.24$ ,  $SD = 0.937$ ), while eating habits 12 (I always choose foods that are high in sugar) obtained the lowest mean value ( $M = 2.67$ ,  $SD = 1.160$ ). For physical factors, the physical factors 5 (Have a busy schedule can cause your meal times to be interrupted) obtained the highest mean value ( $M = 4.31$ ,  $SD = 0.863$ ), while physical factors 2 (Cooking skills cause the irregular eating habits of an individual) obtained the lowest mean value ( $M = 3.36$ ,  $SD = 1.186$ ). For psychological factors, the highest mean is psychological factors 9 (My appetite will increase when I eat with my family) with the value ( $M = 4.15$ ,  $SD = 0.958$ ) while for the lowest mean, there are two psychological factors that obtained the same mean which are psychological factors 11 (I tend to eat unhealthy foods when I'm sad) in mean value ( $M = 3.45$ ,  $SD = 1.186$ ) and psychological factors 2 (I like to eat when i feel lonely), with mean value ( $M = 3.45$ ,  $SD = 1.223$ ). For food consumption trends factors, the highest mean is food consumption trends factors 4 (Consuming foods that are high in calories will cause a person to get various types of diseases in a long period of time) with value ( $M = 4.11$ ,  $SD = 1.002$ ), while food consumption trends factors 6 (I like fizzy and sugary drinks even though I know they are not good for health) obtained the lowest mean value ( $M = 2.97$ ,  $SD = 1.351$ ).

Table 2: Descriptive Analysis

Variable	Questions	Mean Score	Std. Deviation
Eating Habits	I eat regularly every day.	3.14	<b>1.169</b>
	I never skip my meals.	3.00	<b>1.215</b>
	I always take my breakfast.	3.03	<b>1.219</b>
	I practice a nutritious diet.	3.46	<b>0.994</b>
	I limit the intake of snacks.	3.53	<b>1.003</b>
	I usually have fruit as a snack.	3.65	<b>1.090</b>
	I prefer ready meals over cooking at home.	3.25	<b>1.135</b>
	I like to eat late at night.	3.31	<b>1.220</b>
	I only eat fried food twice a week.	2.76	<b>1.167</b>
	I choose vegetables in the food I eat.	3.69	<b>1.124</b>
	I drink at least 1 liter mineral of water every day.	3.92	<b>1.076</b>
	I always choose foods that are high in sugar.	2.67	<b>1.160</b>
	I like to eat fast food.	3.41	<b>1.166</b>

	I know that a good eating habits can prevent myself from getting many types of diseases in the future.	4.28	<b>0.937</b>
	I don't take my eating habits seriously because my body mass index (BMI) is in the normal range.	3.02	<b>1.231</b>
	If my weight is at the level of 'obesity', then I will practice a nutritious diet.	4.06	<b>1.069</b>
<b>Physical Factors</b>	Physical factors can influence an individual's eating habits.	3.99	<b>0.954</b>
	Cooking skills cause the irregular eating habits of an individual.	3.36	<b>1.186</b>
	Delicious food can cause the unhealthy eating habits.	3.76	<b>1.079</b>
	Lack of knowledge about nutritious will affect the eating habits.	4.19	<b>0.920</b>
	Have a busy schedule can cause your meal times to be interrupted.	4.31	<b>0.863</b>
	Eating habits between different gender are not same.	3.83	<b>1.069</b>
<b>Psychological Factors</b>	The food i eat depends on my emotions.	3.93	<b>0.968</b>
	I like to eat when i feel lonely.	3.45	<b>1.223</b>
	I like to eat while doing something like doing an assignment.	3.75	<b>1.245</b>
	My food intake will increase when I feel happy.	3.93	<b>1.005</b>
	I will eat uncontrollably if I am under stress.	3.54	<b>1.230</b>
	The food I eat has a healthy diet.	3.47	<b>0.929</b>
	I always prioritize the nutrients of the food I take.	3.61	<b>0.983</b>
	I prioritize taste over nutrition.	3.78	<b>0.958</b>
	My appetite will increase when I eat with my family.	4.15	<b>0.958</b>
	I will eat a lot when I feel very hungry.	4.07	<b>1.009</b>
	I tend to eat unhealthy foods when I'm sad.	3.45	<b>1.186</b>
<b>Food Consumption Trends Factors</b>	Are current food trends affecting your eating habits?	3.81	<b>1.051</b>
	I prefer to try foods that go viral regardless of the number of calories per serving.	3.55	<b>1.182</b>
	Do you think that this unhealthy food consumption trend does not affect your health?	3.01	<b>1.352</b>
	Consuming foods that are high in calories will cause a person to get various types of diseases in a long period of time.	4.11	<b>1.002</b>
	I have become accustomed to practicing unhealthy eating habits.	3.03	<b>1.123</b>
	I like fizzy and sugary drinks even though I know they are not good for health.	2.97	<b>1.351</b>

## Results of Reliability Analysis

Table 3 shows the result of the reliability coefficient alpha based on the dependent variable and each independent variable. The Cronbach's Alpha value of all variables is 0.914. The dependent variable which is eating habits with 16 questions has Cronbach's Alpha value of 0.827 which is good and acceptable. For the first independent variable, physical factors with 6 questions show Cronbach's Alpha value of 0.717 which is acceptable. The second independent variable, psychological factors which contains 11 questions shows Cronbach's Alpha value of 0.856 which is good. The third independent variable, food consumption factors with 6 questions in the questionnaire provided has Cronbach's Alpha value of 0.722 which is acceptable.

Table 3: Reliability Analysis

Variable	N	Number of items	Cronbach's Alpha
All Variable	123	39	<b>0.914</b>

<b>Eating Habits</b>	123	16	<b>0.827</b>
<b>Physical Factors</b>	123	6	<b>0.717</b>
<b>Psychological Factors</b>	123	11	<b>0.856</b>
<b>Food Consumption Factors</b>	123	6	<b>0.722</b>

### Results of Pearson Correlation Analysis

Table 4 shows the result of Pearson correlation analysis in order to see the relationship of each predictors with eating habits. According to the results, there are a moderate positive significant relationship between all predictors and eating habits. Therefore, the study performs Multiple Linear Regression (MLR) to test the hypothesis testing.

Table 4: Pearson Correlation Analysis

<b>Predictors</b>	<b>Pearson Correlation</b>	<b>P-Value</b>
<b>Physical factors</b>	0.472	0.000
<b>Psychological factors</b>	0.567	0.000
<b>Food consumption trend factors</b>	0.642	0.000

### Results of Multiple Linear Regression Analysis (MLR)

Table 5 shows the result of the multiple linear regression analysis. In multiple linear regression analysis, the interpretation is based on R-square and the result of ANOVA. All predictor variables explained 44.7% of the total variation in eating habits. While, the result of ANOVA, indicates that the model is significant since F value (32.105) is associated with a p-value of  $0.000 < 0.05$  and it obtain that the model fits the data well.

Table 5: Model Summary and ANOVA of MLR

<b>R</b>	<b>R Square</b>	<b>ANOVA</b>	
		<b>F</b>	<b>P-Value</b>
<b>0.669</b>	0.447	32.105	0.000

### Results of Hypothesis Testing

Table 6 shows the hypothesis testing based on multiple linear regression analysis by using enter method. The study indicates that the significant influencing factors on eating habits are psychological ( $p\text{-value} < 0.05$ ) and food consumption trend ( $p\text{-value} < 0.05$ ). While, there is no significant influence of physical factors on eating habits among third year Wellness students at Universiti Malaysia Kelantan ( $p\text{-value} > 0.05$ ). Moreover, factors that most influence eating habits is food consumption trend ( $B = 0.338$ ).

Table 6: Hypothesis Testing

Hypothesis	Regression Coefficients (B)	P-Value	Result (Supported/ Not Supported)
<b>H1 . There is a significant influence of physical factors on eating habits among third year wellness students at Universiti Malaysia Kelantan.</b>	0.062	0.468	H1 is not supported
<b>H2 . There is a significant influence of psychological factors on eating habits among third year wellness students at Universiti Malaysia Kelantan.</b>	0.239	0.006	H2 is supported
<b>H3 - There is a significant influence of food consumption trend factors on eating habits among third year wellness students at Universiti Malaysia Kelantan.</b>	0.338	0.000	H3 is supported

## DISCUSSION AND RECOMMENDATION

The discussion was conducted to address the research questions and research hypotheses stated in this study as in the first chapter of this study. In general, the study was conducted to extensively examine the factors that influence eating habits among third-year Wellness students at Universiti Malaysia Kelantan. Based on findings, each student has their own eating habits, as well as male and female. From the Pearson correlation results, it can be identified that the correlation between physical factors and eating habits obtains a moderate correlation value and not significant influence on eating habits. From the questionnaire, it clearly shows that not many students practice a nutritious diet in their eating habits. Students stated that they like to eat late at night and that they will take their eating habits seriously if their weight is not in the normal range. However, they still choose vegetables in the food they eat. However, less than half of the respondents actually eat regularly every day. Among them, many skip meals and don't always eat breakfast every morning.

Not only that, students also eat fried food at least twice a week. Students who live in rented houses, prefer to buy ready-made food instead of cooking at home. One of the best options to practice healthy eating habits is to practice nutritious food in your daily diet. This is because nutritious food has many advantages contained in it. In addition, psychological factors such as emotions also affect students' eating habits. They like to eat when their emotions are at a happy level. Their appetite will also increase when eating with their family. With that, it is clear that emotions affect the eating habits of an individual. From the study, some of the students who live in rented houses only choose to cook food from home instead of food that has already been prepared outside. However, it depends on how much time they have to prepare the food. This is because, it saves their time. However, choosing healthy foods should be prioritized by balancing the intake of food based on a pyramid food chart.

Research findings are also important for the continuation of future research. The same study that can be carried out should be extended to first year and second year Wellness students or made to tourism and hospitality students. The purpose is to study the factors that influence eating habits among students by expanding the target population set by the researcher to get the best results. This is because students have learned and have knowledge about eating habits and the factors that influence them. Researchers can also use different types of survey methods to get information from respondents such as using personal interviews. Among the advantages obtained from the personal interview method, the researcher will receive a response from the

respondent quickly. Not only that, researchers can also use observation methods to choose, see the behavior and characteristics of eating habits for individuals.

## CONCLUSION

In conclusion, the study was conducted to find out the factors that influence eating habits among third year Wellness students at Universiti Malaysia Kelantan. Although all three factors which are physical factors, psychological factors and food consumption trends factors have a moderate positive significant relationship with eating habits but among these three factors, there are only two factors were significant influence on eating habits which is psychological and food consumption trend while physical factors was not significant influence on eating habits. Hence, the most influence eating habits is food consumption trend.

## REFERENCES

- Akter, M., Sadekin, M. N., & Patwary, A. K. (2020). An Empirical Study on Students' Satisfaction from Mawlana Bhashani Science & Technology University, Bangladesh. *Review of Economics and Development Studies*, 6(2), 363-379.
- Alexandra Baargiota, Maria Delizona, Andreas Tsitouras & Georgios N. Koukoulis. (2013). Eating habits and factors affecting food choice of adolescents living in rural areas. *HORMONES* 12(2): 246-253
- Alom, S., Patwary, A. K., & Khan, M. M. H. (2019). Factors affecting the turnover intention of Bangladeshi migrants in the United Arab Emirates: An empirical study on the hotel industry. *International Journal of Innovation, Creativity and Change*, 8(3), 344-360.
- Amanda Fitzgerald, Caroline Heary, Elizabeth Nixon & Colette Kelly. (2010). Factors influencing the food choices of Irish children and adolescents: a qualitative investigation. *Health Promotion International* 25(3)
- Apolinaras Zaborskis, Reda Lagunaite, Ryan Busha & Jolita Lubiene. (2012). Trend in eating habits among Lithuanian school-aged children in context of social inequality: three cross-sectional surveys 2002, 2006 and 2010. *BMC Public Health* 52(12): 1471-2458.
- Ashraful Kabir, Shahgahan Miah & Asraful Islam. (2018). Factors influencing eating behavior and dietary intake among resident students in a public university in Bangladesh: A qualitative study. *PLoS ONE* 13(6)
- Ewa Babicz-Zielinska. (2006). Role of psychological factors in food choice. *Polish Journal of Food and Nutrition Sciences* (15/56):379-384
- Fengmin, Z., Baijun, W., Jiangtao, B., Li, L., & Patwary, A. K. (2022). Investigating revisit intention of medical tourists in China through nutritional knowledge, perceived medical quality, and trust in the physiologist: A recommendation on health tourism policy measures. *Frontiers in Public Health*, 10, 893497.
- Grossniklaus DA;Dunbar SB;Tohill BC;Gary R;Higgins MK;Frediani J; (n.d.). *Psychological factors are important correlates of dietary pattern in overweight adults*. The Journal of cardiovascular nursing. Retrieved January 10, 2023, from <https://pubmed.ncbi.nlm.nih.gov/20938248/>



- Hazbar, A. M. H., Alem Mohammed, A., & Karim, A. K. A. (2019). An Empirical Study of Factors Influencing hotel customers' online booking Intention. *مجلة العلوم التربوية و الدراسات الإنسانية*, (5), 1-17.
- Homam Alolabi, Mhd Obai Alchallah, Fatema Mohsen, Marah Marrawi & Zaynab Alourfi. (2021). Social and psychosocial factors affecting eating habits among university students in Syria: A cross-sectional study. *Research Square*.
- Kurubaran Ganasegeran, Sami AR Al-Dubai, Ahmad M Qureshi, Al-abed AA Al-abed, Rizal AM & Syed M Aljunid. (2012). Social and psychological factors affecting eating habits in a Malaysian medical school: A cross-sectional study. *Nutrition Journal* 48(11): 1
- Li, L., Ragavan, N. A., Patwary, A. K., & Baijun, W. (2022). Measuring patients' satisfaction toward health tourism in Malaysia through hospital environment, nutritional advice, and perceived value: A study on Chinese exchange students. *Frontiers in public health*, 10, 893439.
- Li, L., Wu, B., & Patwary, A. K. (2022). How marine tourism promote financial development in sustainable economy: new evidences from South Asia and implications to future tourism students. *Environmental Science and Pollution Research*, 29, 1155-1172.
- Li, L., Wu, B., & Patwary, A. K. (2022). The psychosocial factors affecting chinese Outbound Exchange and mobility students' academic performance during COVID-19. *Frontiers in psychology*, 13, 872516.
- Nasrin Sultana Chowdhury. (2014). Eating habits and Nutritional status among the Bangladeshi Medical Students Depending upon BMI. *Updat Dent. Coll .j* 4(1): 10-14
- Patwary, A. K., Roy, B., Hoque, R., & Khandakar, M. S. A. (2019). Process of developing a community based tourism and identifying its economic and social impacts: An Empirical study on Cox's Bazar, Bangladesh. *Pakistan Journal of Humanities and Social Sciences*, 7(1), 1-13.
- Relationship between socio-demographic factors and eating practices in ... (n.d.). Retrieved January 10, 2023, from [https://file.scirp.org/pdf/FNS20120300001\\_84055425.pdf](https://file.scirp.org/pdf/FNS20120300001_84055425.pdf)
- Sami H Alzahrani, Abdulmajeed Abdulaziz Saeedi, Maan Khaleed Baamer, Abdullah Faisal Shalabi & Abdullah M Alzahrani. (2020). Eating habits among Medical Students at King Abdulaziz University, Jeddah, Saudi Arabia. *International Journal of General Medicine* (13):77-88
- Sumethokula, P., Patwary, A. K., Srinuanpanc, B., Srinuanpand, C., Suwandee, P., Thammathikulf, A., & Phanong, W. (2020). The potential of new tour repackaging for creative tourism among entrepreneurs in Nakhon Si Thammarat. *International Journal of Innovation, Creativity and Change*, 13(10), 1752-1771.
- WHO. (1991). Guidelines for the Assessment of Herbal Medicines. Geneva: World Health Organization.
- Wu, B., Liu, S., Wang, J., Tahir, S., & Patwary, A. K. (2021). Assessing the mechanism of energy efficiency and energy poverty alleviation based on environmental

regulation policy measures. *Environmental Science and Pollution Research*, 28, 40858-40870.

Wu, B., Zhai, B., Mu, H., Peng, X., Wang, C., & Patwary, A. K. (2021). Evaluating an economic application of renewable generated hydrogen: A way forward for green economic performance and policy measures. *Environmental Science and Pollution Research*, 1-15.

**Factor Affecting Mental Health Among 3<sup>rd</sup> Year Student at  
University Malaysia Kelantan, City Campus.**

*Nurul Aisyah binti Ibrahim, Nurul Syaadah binti Chik, Sharifah Nurul Hayati binti  
Syed Anuar, Siti Zulaikha binti Zolkurnain & \*Mohd Firdaus bin Mohd Nasir  
Faculty of Hospitality, Tourism and Wellness, Universiti Malaysia Kelantan  
Corresponding email: mfirdaus@umk.edu.my*

---

**ABSTRACT**

---

6. Mental health is important for every stage of life including childhood, teenagers, adults, and others. There are many effects that can lead to mental health issues among university students. Mental health among students is increasingly concerned and very important for students because it is related to emotional, psychological also social well-being. The study is focusing on the factors that cause mental health among 3<sup>rd</sup> year FHPK student at University Malaysia Kelantan, City Campus which is to identify the effect of time management on mental health among 3rd year students at University Malaysia Kelantan, City Campus, to determine the effect of environment on mental health among 3rd year students at University Malaysia Kelantan, City Campus and to examine the effect of lifestyle factor on mental health among 3rd year students at University Malaysia Kelantan, City Campus. The study was conducted using a quantitative research approach which is through online questionnaire to collect the data. There were 250 respondents participated in the study which had been conducted through social media such as WhatsApp group and it focused on the third years FHPK students in Universiti Malaysia Kelantan, City Campus.
- 

**Keywords: Mental Health, Time Management, Lifestyle, Environment**

---

## **INTRODUCTION**

The chapter gives an outline of introduction about the research of mental health among 3rd year students at University Malaysia Kelantan, City Campus. This section collaborates on the background of the study and the problem statement of study. This research question and research objective for this research are also stated in this chapter to give an initial overview of the purpose of this study. This chapter also discusses the scope and the significance of the study along with the definition of term for each information contained in this study. There were three objective of this research which are:

1. To identify the effect of time management on mental health among 3rd year students at University Malaysia Kelantan, City Campus.
2. To determine the effect of environment on mental health among 3rd year students at University Malaysia Kelantan, City Campus.
3. To examine the effect of lifestyle factor on mental health among 3rd year students at University Malaysia Kelantan, City Campus.

## **SIGNIFICANCE OF THE STUDY**

### **Ministry of Health (MOH), Malaysia.**

Based on Ministry of Health (MOH Malaysia point of view, this research can gain an information about mental health among university students and show the importance of it. According to MOH, statistic has been revealing that the worst state on mental health among Malaysian students, from one to ten individuals in 2011 to one in five in 2016. From this study, it can trigger the sensitivity of the ministry to come out the best services mental health centre that will help to decreasing the number of mental health disease among the university students. As a result, not only student will get the benefits but also the ministry. By doing that, it will help to minimize the mental health and stress level so they can perform very well in the academic and co-curriculum. Moreover, the number of mental health disease among university students will reduce by time under the government's control. This finding could help in changing the perception of mental health among university students.

### **University students.**

The one that related on this research is university student and the study will help them to understand the factor of mental health among university students. University students

can refer to this research to know more about factor that cause the mental health and also will gain them some knowledge so that they can practice in their daily life in order to have a better life as a students. This study offers information on mental health and ways that universities, particularly students at University Malaysia Kelantan, might address these problems. Because of the importance of the study, it is anticipated that participants will comprehend how factors such as environment, lifestyle, and time management have an impact on their mental health. Armed with this knowledge, participants will be better equipped to manage this issue and succeed as university students.

## **LITERATURE REVIEW**

### **MENTAL HEALTH**

Basically, the World Health Organization (WHO), has defined mental health as:

"...a state or aspect of physical, mental, and spiritual as well as social well-being. These three aspects need to be fulfilled by everyone to achieve an optimal level of health. When a person is in good mental health, he or she may function efficiently at work and at home and can make a positive contribution to society. (World Health Organization, 2018). But the most famous definition of mental health and used by WHO as: "... a state of complete physical, mental, and social well-being and not mere absence or infirmity." (WHO, 2012).

This shows that mental health is not only a problem of stress but emphasizes how an individual overcomes the problem of mental stress. Therefore, aspects of adolescent mental health development are important to pay attention to and discuss. They need elements of positive development, especially aspects of cognitive development and social skills for the well-being of their lives (Hezzrin & Norsuhaily, 2020; Pauzi, 2019).

### **TIME MANAGEMENT FACTORS**

According to Claessens et al, (2007) this definition of time management has been summarized as a behavior that aims to achieve effective use of time while performing specific purposeful activities. In this way, the definition of time does not focus on time itself emphasizing goal-directed behavior, to be achieved within a time frame or

through efficient use of time. He also noted that time management skills can have an impact on anxiety and distress.

Meanwhile W. Rossler (2012) discovered that those who have trouble managing their time are more likely to battle with stress, sleep disorders, anxiety, depression, and other mental health issues. Philip G. Levendusky (2021) found that time management is not only important to get things done on time for your work. Mental health care and timely mental health care training should be developed and implemented as part of professional development activities.

## **ENVIRONMENT FACTORS**

The psychosocial environment, which is characterised as having standards, expectations, and beliefs, is what is referred to as the school climate and it determines how safe people feel physically, emotionally, and socially. (2009) Cohen et al. Another element that influences kids' mental health issues is their environment. The purpose of this study was to determine the role that environmental factors have in the mental health issues that third-year students at Universiti Malaysia Kelantan experience. There have been requests for more diverse research designs (Thapa et al., 2013), more rigorous and complicated research designs (Wang & Degol, 2016), as well as deeper research into how various aspects of the institutional environment can influence student, individual, or group learning outcomes. (Wang & Degol, 2016) group.

### **Family Environment**

According to McIntyre JC et al. (2018), topics pertaining to student experiences in childhood and before to attending university were investigated. Murray E, et al. (2019) also investigated the impact of ACE (Adverse Childhood Experiences), which Feletti VJ (2009) measured using the same scale. This study was conducted to find out different mental health outcomes including positive and negative effects, prevention methods, despair, anxiety, and suicide risk, as well as existing mental health issues, use of mental health services, and psychological adjustment. University students' bad mental health is significantly and favourably related to ACE, according to research that has been done in this area.

### **Research Hypothesis**

According to the literature study mentioned above, time management, lifestyle factors, and environment are the problems that affect the mental health of third-year students at University Malaysia Kelantan. All the aforementioned factors are known as

independent variables, whereas university students' mental health is a dependent variable. The study's hypothesis basically asks whether the independent variables and dependent variable have any discernible effects on one another.

H1: There is a relationship of time management on mental health among 3<sup>rd</sup> year FHPK student in University Malaysia Kelantan, City Campus.

H2: There is a relationship of environment on mental health among 3<sup>rd</sup> year FHPK student in University Malaysia Kelantan, City Campus.

### **Research Framework**

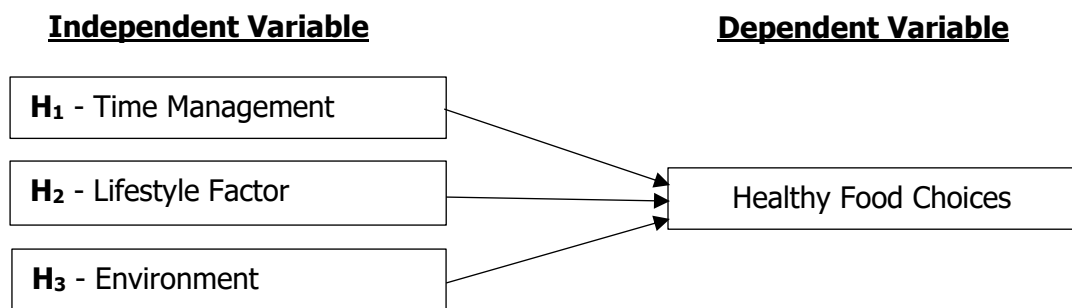

## **METHODOLOGY**

### **Research Design**

Research design is a technique and framework that will be chosen by the researcher to find out specific design of the study. A research design is a collection of procedures and methods used to gather and analyse data on the variables listed in the research topic. (Andrew B, 2018). This framework of research design will help the research to find out the method for this research design to successfully accomplish this study. The design of this research was done comprehensively, involving studies being conducted. This is due to the research method conducted covers all the data taken in this study. Research design is a technique and framework that will be conducted by the researcher to execute the answer to research question of the study. The researcher uses quantitative method to approach of this study. A quantitative research approach has been used for the study of factor mental health among 3<sup>rd</sup> year students at University Malaysia Kelantan, City Campus.

### **Data Collection**

The process of gathering, measuring, and analysing accurate insights for research purposes using established, accepted procedures is referred to as data collection, according to Emily McLaughlin (2018; supported by the evidence acquired, a researcher can evaluate their hypothesis). The first and most important step in most research projects, regardless of the subject, is data collection. The primary data gathering is divided into two parts. Data main refers to the type of information that was gathered for the study through interviews, questionnaires, experiments, and other means. The information is primarily used in the study to support their chosen topic and objective, which is supported by data.

Researchers collect primary data directly from primary sources such as survey like used a questionnaire through the Google form. The questionnaire is applied to collect the information regarding that lead to the factors that affecting mental health among third year FHPK students in Universiti Malaysia Kelantan, City Campus. The questionnaire was distributed using an online platform to all third years FHPK students at Universiti Malaysia Kelantan, City Campus. The questionnaire was distributed through online and social media like WhatsApp and collected data among the third years wellness student. The students answered the questionnaire according to the condition and related to their current situation as well.



## Sampling

In this research, the researchers use a probability sampling technique which is simple random sampling. Respondents consist of third years FHPK student at Universiti Malaysia Kelantan, City Campus. The number of respondents is around 250 students. Researchers use the random numbers generator, and it is using physical measures of temperature, phase noise, clock signals, and other non-deterministic inputs, random number generators are hardware or software programmers that produce random numbers as an output. Respondents from the questionnaire were university students from third years wellness students. University students from third years FHPK students were selected for this survey because most students from third years FHPK students were probably experienced in mental health. Respondents were selected to answer this questionnaire and all data were collected based on their answers.

## Data Analysis

The data was evaluated by the researcher using SPSS 28 (Statistical Package for the Social Sciences). In this study, four different forms of data analysis—frequency analysis, descriptive analysis, reliability analysis, and correlation analysis—were used. While descriptive analysis was used to describe the level of agreement of the variable, frequency analysis was employed to assess the demographic profile of respondents. To make sure the survey data was accurate and served its goal, reliability analysis was used. A valuable method for assessing any correlation and the strength of a linear relationship between an independent variable (IV) and a dependent variable (DV) is the correlation analysis, often known as the Pearson Correlation Test.

## FINDINGS

### Results of Frequency Analysis

Table 1: Socio-demographic Characteristics

No	Socio-demographic characteristic	Frequency (n)	Percentage (%)
1	Gender	250	100
	Male	67	26.8
	Female	183	73.2

<b>2</b>	<b>Race</b>	<b>250</b>	<b>100</b>
	Malay	231	92.4
	Chinese	7	2.8
	India	7	2.8
	Others	5	2.0
<b>3</b>	<b>Age</b>	<b>250</b>	<b>100</b>
	19-21 years	20	8.0
	22-24 years	211	84.4
	25-27 years	19	7.6
<b>4</b>	<b>Programme</b>	<b>250</b>	<b>100</b>
	SAH	79	31.6
	SAP	77	30.8
	SAS	94	37.6
<b>5</b>	<b>City</b>	<b>250</b>	<b>100</b>
	Pengkalan Chepa, Kota	250	250
	Bharu		

Data of descriptive analysis obtained from Part A in questionnaire where on demographic variables includes of gender, race, age, study program involved, as well as city. This questionnaire study focuses on 3rd year FHPK students of Universiti Malaysia Kelantan.

Table 4.2 shows the results of descriptive analysis of respondents. The researcher focused on 3rd year FHPK students of Universiti Malaysia Kelantan to answer this questionnaire. Based on the evaluation in the table, the female gender gets the highest frequency compared to the male which is a total of 183 respondents with a percentage (73.2%). While there were 67 male respondents with a percentage (26.8%). Most of the Malay respondents who answered this questionnaire were 231 people (92.4%). Chinese and Indian only got 7 respondents (2.8%) and others got 5 respondents (2.0%).

Following the respondent's age, the highest age frequency of respondents is from 22-24 years old with 211 respondents (84.4%). While the age frequency for the 19-21-year-old stage got 20 respondents (8.0%) and the 25-27-year-old stage got 19 respondents (7.6%). The program offered in this survey has only 3 programs namely Sah, Sap and Sas. In these three programs Sas got the most respondents which is 94 respondents (37.6%). The Sah program had a total of 79 respondents (31.6) and the Sap program

had a total of 77 respondents (30.8%). All of the respondents involved are from Pengkalan Chepa, Kota Bharu because it only involves university students in Kelantan.

## Result of Descriptive Analysis

Table 2 shows the result of descriptive analysis of variable.

Table 4: Descriptive Analysis

Variable	Items	Mean Score	Standard Deviation
<b>Time</b>	Lack of rest on weekend.	3.7250	1.02699
<b>Management Factor</b>	Often feel stressed because of not being able to complete academic tasks or other responsibilities on time.	3.7560	1.04154
	Often feel anxious or worried when thinking about schedules and tasks that must be completed.	3.9360	0.95475
	Finding it difficult to sleep because of many tasks or responsibilities that must be completed.	3.7640	1.00015
	Often feel out of control or feel exhausted by academic tasks or other responsibilities.	3.6840	0.98592
<b>Lifestyle Factors</b>	I often neglect a healthy lifestyle and do not practice exercise activity.	3.2280	1.11579
	I lacked awareness about the importance of a balance lifestyle to mental health.	3.0440	1.20993
	I do not take care well about my sleep schedule.	3.6960	1.15278
	I was not practiced healthy eating habits on a regular basics.	3.4280	1.13577
	I was often exposed to unhealthy environments such as noisy and toxic environments.	3.2640	1.23629
	I do not get support from family or friends.	2.6000	1.23210

<b>Environment</b>	I feel isolated from friends.	2.7800	1.23682
<b>Factors</b>	I have difficulty or lack of sleep.	3.5040	1.22638
	I feel lack of enthusiasm.	3.3760	1.15236
	I like to think negative things.	3.2480	1.23312

Table 2 presents the mean and standard deviation of the first independent variable which is the time management factor. Based on the table, the lowest mean score is in time management factor 5 which is (m=3.6840, SD=0.98592) followed by time management factor 1 (m=3.7520, SD=1.02699) and time management factor 2 which has a mean (m=3.7560, SD=1.04154). With the evaluation based on the table, the second highest mean score is in time management factor 4 with (m=3.7640, SD=1.00015) while the highest score is time management factor 3 (m=3.9360, SD=0.95475). It has been shown about the mean and standard deviation of the second independent variable which is the lifestyle factor. In the table, lifestyle factor 3 has the highest mean score among the others which is (m=3.6960, SD=1.15278). Followed by lifestyle factor 4 in the highest mean (m=3.4280, SD=1.13577). While lifestyle factor 5 got a mean score of (m=3.2640, SD=1.23629) and lifestyle factor 1 got a mean score of (m=3.2280, SD=1.11579). Lifestyle factor 2 got the lowest mean score among the others (m=3.0440, SD=1.20993). Table 4.7 presents the mean and standard deviation of the third independent variable, which is the environmental factor. Based on the evaluation in the table, environmental factor 3 mean (m=3.5040, SD=1.22638) has got the meanest score compared to others. Environmental factor 4 became the second highest mean which is (m=3.3760, SD=1.15236) followed by environmental factor 5 which is (m=3.2480, SD=1.23312). While for environment factor 2 got the second lowest mean score as much as (m=2.7800, SD=1.23682). The lowest mean score is environment factor 1 which is as much as (m=2.6000, SD=1.23210).

### **Result of Reliability Analysis**

Table 3 shows the result of reliability analysis based on dependent variable and independent variable.

Table 5: Reliability Analysis

<b>Variable</b>	<b>Number of Items</b>	<b>Cronbach's Alpha</b>
<b>Time Management Factors</b>	5	0.885
<b>Lifestyle Factors</b>	5	0.796

<b>Environment Factors</b>	5	0.847
<b>Physical Activity Factors</b>	8	0.873

The reliability coefficient alpha based on the dependent variable and each independent variable is displayed in Table 4.6. All variables have a Cronbach's Alpha value of 0.851. The five-question dependent variable on mental health has a good and acceptable Cronbach's Alpha score of 0.843. The result of 0.885 for Cronbach's Alpha for the first independent variable, time management factors with 5 questions, is good, trustworthy, and acceptable. The Cronbach's Alpha score for the second independent variable, lifestyle factors, which consists of 5 questions, is 0.796, which is good, reliable, and acceptable. The third independent variable, environment factors, has a good Cronbach's Alpha value of 0.847 and 5 items in the given questionnaire. Results from all factors are highly correlated.

## **DISCUSSION AND RECOMMENDATION**

Based on this research, there are a few factors affecting mental health among third year FHPK students at University Malaysia Kelantan have been determined. This study was conducted to ensure that students can take care of their mental health well and to know how many students are involved or not in mental health, so that this problem can be prevented before it is too late. First and foremost, the recommendation is to enlarge the target demographic or respondents which include all FHPK students at University Malaysia Kelantan, City Campus in future study. The next recommendation for future research is that the researchers should use a variety of survey techniques to get the respondents through the questionnaire. The researchers can use telephonic surveys or another survey technique which is in-person personal interviews. Finally, the researchers can expand the rental house area among all years of FHPK students around the University Malaysia Kelantan, City Campus for the respondents is the recommendation to improve the future studies.

## **CONCLUSION**

This study examines the variables influencing the mental health of University Malaysia Kelantan's City Campus third year FHPK students. The three independent variables (IV) and the dependent variable (DV) in this study were related to one another. Overall, the study's limitations stem from the third year FHPK students at University Malaysia Kelantan's City Campus's lack of interest in the questionnaire, their lack of

comprehension, and their difficulties in gaining access to them. Expanding the target group, utilising more survey techniques, and using several languages are suggested as important in future research.

## REFERENCES

- Adam Felman. (2020). What is mental health? Retrieved December 10, 2022 from <https://www.medicalnewstoday.com/articles/154543#definition>
- Akter, M., Sadekin, M. N., & Patwary, A. K. (2020). An Empirical Study on Students' Satisfaction from Mawlana Bhashani Science & Technology University, Bangladesh. *Review of Economics and Development Studies*, 6(2), 363-379.
- Alom, S., Patwary, A. K., & Khan, M. M. H. (2019). Factors affecting the turnover intention of Bangladeshi migrants in the United Arab Emirates: An empirical study on the hotel industry. *International Journal of Innovation, Creativity and Change*, 8(3), 344-360.
- Comprehensive guide to research methodology. (n.d.). Retrieved January 2, 2023, from <https://nairaproject.com/m/blog/006.html>
- Fengmin, Z., Baijun, W., Jiangtao, B., Li, L., & Patwary, A. K. (2022). Investigating revisit intention of medical tourists in China through nutritional knowledge, perceived medical quality, and trust in the physiologist: A recommendation on health tourism policy measures. *Frontiers in Public Health*, 10, 893497.
- Hazbar, A. M. H., Alem Mohammed, A., & Karim, A. K. A. (2019). An Empirical Study of Factors Influencing hotel customers' online booking Intention. *مجلة العلوم التربوية و الدراسات الإنسانية*, (5), 1-17.
- June 22, 2018, Apps, S. G. linkF. T. P. E. O., March 05, 2017, comments, 19, more, R., June 21, 2018, & comments, 14. (n.d.). Research design. *Research Design*. Retrieved January 2, 2023, from <http://diahrhmwthoughts.blogspot.com/2018/06/research-design.html>
- Li, L., Ragavan, N. A., Patwary, A. K., & Baijun, W. (2022). Measuring patients' satisfaction toward health tourism in Malaysia through hospital environment, nutritional advice, and perceived value: A study on Chinese exchange students. *Frontiers in public health*, 10, 893439.
- Li, L., Wu, B., & Patwary, A. K. (2022). How marine tourism promote financial development in sustainable economy: new evidences from South Asia and implications to future tourism students. *Environmental Science and Pollution Research*, 29, 1155-1172.
- Li, L., Wu, B., & Patwary, A. K. (2022). The psychosocial factors affecting chinese Outbound Exchange and mobility students' academic performance during COVID-19. *Frontiers in psychology*, 13, 872516.
- Merriam Webster. (2020). Probabilities. Retrieved December 24, 2022, from <https://www.merriam-webster.com/dictionary/probability>
- Patwary, A. K., Roy, B., Hoque, R., & Khandakar, M. S. A. (2019). Process of developing a community based tourism and identifying its economic and social impacts: An Empirical study on Cox's Bazar, Bangladesh. *Pakistan Journal of Humanities and Social Sciences*, 7(1), 1-13.

- Rebecca Bevans (2020). Multiple Linear Regression | A Quick Guide (Examples). Retrieved from <https://www.scribbr.com/statistics/multiple-linear-regression/#:~:text=What%20is%20multiple%20linear%20regression,variables%20using%20a%20straight%20line>.
- Research population. Research Population - The Focus Group of a Scientific Query. (n.d.). Retrieved January 2, 2023, from <https://explorable.com/research-population>
- Sampling frame: Definition, examples. Statistics How To. (n.d.). Retrieved January 2, 2023, from <https://www.statisticshowto.com/probability-and-statistics/statistics-definitions/sampling-frame/>
- Sumethokula, P., Patwary, A. K., Srinuanpanc, B., Srinuanpand, C., Suwandee, P., Thammathikul, A., & Phanong, W. (2020). The potential of new tour repackaging for creative tourism among entrepreneurs in Nakhon Si Thammarat. *International Journal of Innovation, Creativity and Change*, 13(10), 1752-1771.
- Unknown (2023). What is Multiple Linear Regression? Retrieved from <https://www.statisticssolutions.com/free-resources/directory-of-statistical-analyses/what-is-multiple-linear-regression/>
- World Psychiatric Association. (2015). Toward a new definition of mental health. Retrieved December 10, 2022, from <https://www.ncbi.nlm.nih.gov/pmc/articles/PMC4471980/>
- Wu, B., Liu, S., Wang, J., Tahir, S., & Patwary, A. K. (2021). Assessing the mechanism of energy efficiency and energy poverty alleviation based on environmental regulation policy measures. *Environmental Science and Pollution Research*, 28, 40858-40870.

# IDENTIFYING THE CHALLENGES AND THE LEVEL OF EFFECTIVENESS OF CAMPUS WELLNESS INITIATIVES AMONG STUDENTS AND STAFF IN UMK CITY CAMPUS

Husna Shahraini Binti Burha'an nuddin, Muhammad Nuriman Syafiq Bin Lokman, Nur Syafiqah Amira Binti Hamid, Nurul Zulaikha Bin Azhan & \*Mohd Firdaus Bin Mohd Nasir

*Faculty of Hospitality, Tourism and Wellness, Universiti Malaysia Kelantan*

*Corresponding email: [mfirdaus@umk.edu.my](mailto:mfirdaus@umk.edu.my)*

---

## ABSTRACT

A wellness programme is to maintain and improve a person's health through a balanced diet, regular exercise, stress reduction, and disease prevention. There are various challenges that contribute to the lack of implementation of Campus Wellness Initiatives among students and staffs, including a lack of understanding about personal health, the problem of obesity, which limits daily mobility and causes fast food intake. As a result, participation in these wellness initiatives is reduced. Therefore, the study aimed to explore the effectiveness that motivate, to assess the extent of support provided by campus leadership support, to determine the level of awareness, to assess the level of interest and to investigate the level of satisfaction of facilities among students and staff in campus wellness initiatives. The study was conducted using a quantitative research approach which is through online questionnaire survey in Google Form to collect the data. There were the 362 respondent consists of students and staff from the UMK City Campus. Based on the research findings, the research objectives of motivation, leadership support, participant awareness and participant interest were supported except the facilities, -.230 is not significant. All the hypotheses have been accepted at a significant level of 0.01, meanwhile the facilities showed that is not significant at  $p > 0.05$ . A few implications related to the research study are the researcher is difficult to get superiors to become respondents, during covid 19, respondents lacked involvement in health initiatives and were unable to know the effectiveness of the program and the difficulty in finding journals related to the research topic being studied. The implications related to the study have been proposed by the researcher.

**Keywords: Campus Wellness Initiatives, Effectiveness, UMK City Campus**

---

## INTRODUCTION

The concepts "wellness" and "well-being" can be found in a variety of literary genres, including general social commentary, economics, social science, and food marketing. These phrases are frequently employed in contexts that cover both more general and esoteric aspects of life pleasure, such as happiness, as well as mental, physical, and emotional health. Wellness has a direct impact on one's ability to work and labour productivity, the nation's economy, the moral atmosphere in society, young people's education, and how one is perceived and how well one is living. The improvement of the students' quality of life is mostly due to the promotion of health. Indicators of the general personal culture include people's involvement in their own well-being and care, prevention of wellness illnesses, personality tendencies, such as personal health consciousness in many facets of life (Nesterchuk et al., 2020).

Surveys measuring physical, emotional, social, intellectual, and vocational wellbeing were given to participants. Significant institutional variations were reported for measures of physical and social health (Baldwin et al., 2017). Six broad categories of health-related behaviours make up holistic wellness: physical wellness, including eating plan, workout, sleep, smoking, alcohol use, and personal care; emotional wellness, including self-identity and self-esteem; spiritual wellness, including peace and connection with the universe; social wellness, including a sense of community and social support; occupational wellness, including job satisfaction; and intellectual wellness (e.g., creative stimulating mental activities).



As an increasing number of students seek physical and mental health services, college student wellness has become an increasingly important topic in higher education (Staples et al., 2022). Many people have suggested that wellness should be thought of holistically, encompassing not only bodily but also spiritual and mental aspects (Staples et al., 2022). In response to these requests for holistic wellness, studies in higher education have looked into components of moral well-being, such as meaning, direction and purpose in life (Lothes & Nanney, 2019). Then again, to the growth of wellness techniques with a spiritual foundation, such mindfulness and meditation (Lister et al., 2021).

The objectives of this study are as follows :

1. To explore the effectiveness that motivate students and staff to participate in campus wellness initiatives.
2. To assess the extent of support provided by campus leadership support towards wellness initiatives.
3. To determine the level of awareness of students and staff regarding the available campus wellness initiatives.
4. To assess the level of interest among students and staff in participating in wellness initiatives.
5. To investigate the level of satisfaction among participants with the existing wellness facilities in the campus.

## **Significance of the study**

### ***Students***

The study's findings are significant because if many wellness initiatives are conducted on campus, students will be able to learn a few ways to overcome health problems in themselves and be able to incorporate strategies for maintaining a healthy lifestyle into their everyday routine. Therefore, it benefits pupils to increase their knowledge. Students that participate in wellness initiatives can teach it to other students. In addition, wellness initiatives can provide many benefits to the student's lifestyle.

### ***Body of Knowledge***

Examining empirical research on the subject can help a student acquire a fresh approach to resolving a problem that has been brought up in prior research projects. For example, the method used to gather the data, the sample size, and each data analysis can be modified to focus on a different issue and provide a distinctive study (Rafael, 2018). These opportunities to engage with health programs are great to avoid excessive waste of resources and this can improve the quality of health.

This study intends to provide more precise details regarding the difficulties experienced by campus wellness initiatives and to inform upcoming researchers about the availability of data on campus wellness initiatives among students or staff. This aids in deepening the investigation into the subject pertaining to the difficulties and success of campus wellness initiatives.

### ***University***

This study will benefit university as useful knowledge that everyone should learn. When the wellness initiatives are reactivated among students or staff, this institution will eventually understand what crucial techniques and programmes are required for a daily healthy living. It can also identify what factors or ways to improve wellness initiatives. So that, it can implement the program more effectively to the students and staff. It is also to prevent the waste of resources from happening. For example, responding to a challenge by participating in a national sports day.

### ***Community***

Wellness initiatives also benefit the community. If the wellness programmed and activities is successful, we can replicate to the community. How important wellness initiatives are to the community because one of the goals is to produce a good health and wellbeing society. By creating socially inclusive wellness initiatives, communities can support people in living fulfilling lives and have a good impact on their general health. A healthy community benefit everyone in it. And community health is one way to achieve a healthy community. That is why it is important for students at University of Malaysia Kelantan as students are usually very familiar with the community and they can practice it to the community.

### ***Health Management***

This phrase describes the overall management and direction of both governmental and private healthcare organizations. In essentially, the goal of healthcare management is to make sure that everything in the healthcare sector runs properly (Wager et al., 2021). Wellness programs have to do with Health management. That is why wellness initiatives are important and can benefit Health Management. It is also to prevent the waste of resources from happening.

## **LITERATURE REVIEW**

### **Motivation**

Motivation is crucial for identifying variables that might affect why people decide to finish the course. For example, perceived internal and personal incentives for completing a task or action, such as greater knowledge or a sense of success or self-worth, can be classified as intrinsic or extrinsic sources of motivation. A person's want to conduct or act in a way that will satisfy specific conditions or demands, which typically includes wishes, desires, or objectives, is referred to as motivation (Yilmaz et al., 2017).

According to certain research, when we feel powerless to exert control, for instance, we tend to give up easily (Gacek et al., 2017). Others have demonstrated that when we are pressured, we lose access to our inner resources for motivation (Ryan & Deci, 2019). Mental health problem among student can be reduce by gain motivation in wellness initiatives university (Al-Kumaim et al., 2021) . Programs for wellness actively involve students in activities that reduce anxiety, stress, and other mental health issues that may have an impact on how well they learn. In order for students to have successful futures, educators must provide them with the knowledge, abilities, and general health and well-being. Increasing wellness initiatives can benefit both the educator and the student.

### **Leadership Support**

There are numerous definitions and interpretations of leadership. The leadership development models that originated in the framework of work organisations had limited application to students in learning environments as a result of emphasising employee-employer relations in a corporate environment (Shek & Lin, 2016). One of the earliest theories of leadership was the "Great Man Theory," which claimed that leaders were born, not made (Lumpkin & Achen, 2019).

### **Participant Awareness**

People need knowledge about the actions and intentions of their co-workers when they collaborate in a shared setting, whether it be virtual or not. Successful cooperation requires this knowledge, especially when using groupware solutions (Collazos et al., 2018). One of the most well-known definitions of awareness is a comprehension of other people's activities, which provides context for a person's own activity. This knowledge of others is the outcome of the interaction of the participants and their environment (Collazos et al., 2018).

The prevalence of depression and anxiety disorders was found to be undergraduate students received 15.6%, while graduate students received 13.0%., indicating that there are a variety of mental health issues on college campuses for which students need support (Lipson & Eisenberg, 2017). 14.9% of

college students reported having received a diagnosis of depression at some point in the past, of whom 32% had experienced depression in the previous year, 24.5% were undergoing psychotherapy at the time of the research, and 35.6% were taking an antidepressant (Oswalt et al., 2018).

There is a severe lack of participant awareness of mental health issues, particularly among students. This presents a significant challenge because students tend to think this issue is common because they are unaware that they can participate in health programmes and activities at the same time. Lack of understanding of the extent to which particular situations could precipitate signs of mental illness. Given the various triggers for mental illness that college students experience (Dieringer et al., 2017).

### **Participant Interest**

The majority of health initiatives only reach people who are already driven to take care of their health, according to ongoing studies of participation rates in wellness programmes and activities. Less motivated people will avoid topics like clear awareness of mental health issues and the significance of wellness programmes and activities. The people who are least knowledgeable about the subject are those who need this incentive the most. The fact that student health efforts are overly complicated, time-consuming, or challenging is another factor in the low participation rates in wellness initiatives.

The evidence for success is less positive if the objective of health programming is to lower health care costs, reduce absenteeism, or improve chronic health issues (Heidi Zwart, 2018). As we all know, university students are less interested in wellness initiatives if they are not given the proper emphasis, and if they are not given more attention, they are exposed to the hazards of this mental health to students.

### **Facilities**

The type of campus recreation facilities is sometimes one of the deciding considerations for college enrollment for college students (Andre et al., 2017). Additionally, obtaining a degree after successfully completing a college career is one of the top focuses for institutions across the country (Makubuya et al., 2020). Student outcomes related to campus recreation, according to the Council for the Advancement of Standards in Higher Education (CAS), can be used to gauge the effectiveness of campus health and wellness programmes (Wells, 2015).

Recreational sports departments should use the dimensions associated with these domains as benchmarks for their programming and providing services. Learning outcomes for students are distinctive client qualities that might give the facility information about the likelihood of client intention for referral and repeat business. To maximise the effects of leisure activities on the student body on service delivery, collegiate recreation departments collaborate with campus stakeholders to ensure that they are promoting the educational objectives for their institutions (Makubuya et al., 2020).

Institutions that offer services for students that connect to recreation frequently think about how to improve students' lives and experiences. Climbing walls, elevated walking or jogging tracks, and other sophisticated recreation facilities are now commonplace, and a variety of other attractions rather than the outdated locker rooms and court gymnasiums (Kampf et al., 2018).

## Research Hypothesis

The literature review highlighted that the independent variables like motivation, leadership support, participant awareness, participant interest and facilities that effectiveness of campus wellness initiatives among student and staff in UMK City Campus. Therefore, the study planned to examine the level of effectiveness among these variables. Based on the literature discussed, the hypotheses of this study were summarized in the following manner:

**H1:** There is a relationship between the motivation among student and staff, and the effectiveness of the wellness initiatives.

**H2:** There is relationship between leadership support and the effectiveness of wellness initiatives effectiveness.

**H3:** There is a relationship between participant awareness and the effectiveness of wellness initiatives.

**H4:** There is a relationship between participant interest and the effectiveness of wellness initiatives.

**H5:** There is a relationship between facilities and the effectiveness of wellness initiatives.

## Research Framework

The Figure 1 below shows the research framework use for this study.

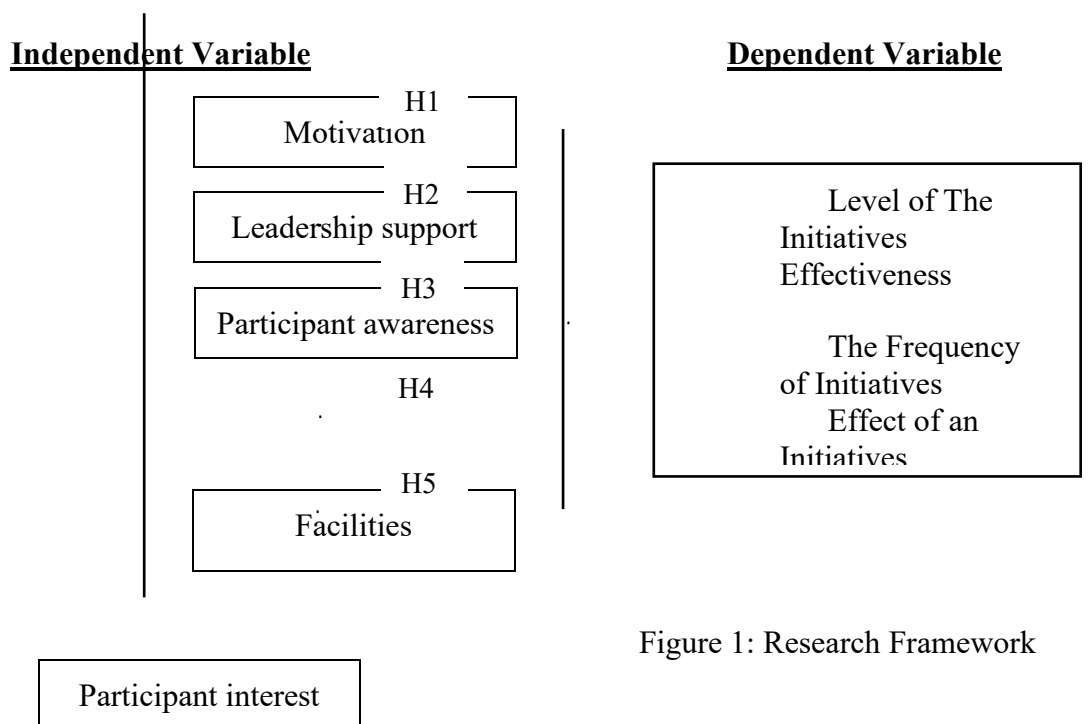

Figure 1: Research Framework

## METHODOLOGY

### Research Design

This research design is a framework that has been created to find overall answers to the overall answer to the research questions conducted the approach of this study is to use quantitative methods. A quantitative research approach has been used for the study of the level of effectiveness of campus wellness initiatives among students and staff in UMK City Campus. The most effective approach for the study can be viewed as a research design, which is an interpretative methodology. The questionnaires utilised in this study's

examination structure are a quantitative approach, and all of the information collected from respondents will be used as the study's primary data.

### **Data Collection**

Researcher collect primary data directly from primary sources such as survey like used questionnaire through the Google form. The questionnaires were given to students and staff of UMK City Campus for provide insight into the challenges of the campus wellness initiatives and its relationship with the effectiveness of the program. The questionnaire was distributed through online and social media like WhatsApp and collected data among students and staff in UMK City Campus. The students answered the questionnaire according to the condition and related to their current situation as well.

### **Sampling**

The researcher will use the non-probability technique. By taking into account the population's and the survey's time constraints, the researchers adopted the convenience sampling technique, which is in non-probability sampling. Convenience sampling is also easy to do because researchers can get sampling information in a short time and this sampling method can also save research costs. The students and staff of UMK City Campus are to receive the questionnaires. Convenience sampling will be used in this research project because Universiti Malaysia Kelantan's City Campus student and staff populations are relatively huge. This is due to the fact that students from the Faculty of Hospitality, Tourism and Wellness (FHPK), the Faculty of Entrepreneurship & Business (FKP) and Faculty of Veterinary Medicine (FPV) attend University Malaysia Kelantan (UMK) City Campus. The researcher will utilize this sampling technique on 362 respondents, as it will be hard to include the entire population of 6522 students and staff at UMK City Campus given the low participation rate. Respondents were selected to answer this questionnaire and all data were collected based on their answer.

### **Data Analysis**

The researcher using Statistical Package for the Social Sciences (SPSS) version 26 to analysed the data obtained. Measurements based on SPSS data include mean, variance, standard deviation, and the frequency. The researcher chose a straightforward descriptive analysis, reliability analysis and correlation analysis to evaluate the data. Frequency analysis was used to analysed demographic profile of respondents while descriptive analysis was used to describe the level of effectiveness of the variable. The three main categories of descriptive statistics are frequency distribution, measures of variability, and measures of central tendency. Reliability analysis was used to ensure the data from questionnaire was reliable and satisfied the purpose. The inference statistic using Pearson Correlation when two continuous variables are compared, the coefficient measures the strength and direction of the linear relationship between an independent variable (IV) and a dependent variable (DV), divided by the components of the standard deviation.

## **FINDINGS**

### **Result of Frequency Analysis**

Table 1 shows the result of frequency analysis of respondents.

Table 1: Frequency Analysis

<b>Characteristics</b>	<b>Frequency</b>	<b>Percentage (%)</b>
<b>Gender</b>		
Male	108	29.8
Female	254	70.2
<b>Age</b>		

18 – 21 years	29	8.0
22 – 25 years	301	83.1
26 – 29 years	25	6.9
30 years and above	7	1.9
<b>Marital Status</b>		
Single	333	92.0
Married	29	8.0
<b>Ethnicity</b>		
Malay	307	84.8
Chinese	29	8.0
Indian	23	6.4
Others	3	0.8
<b>Employment</b>		
Staff	31	8.6
Student	331	91.4
<b>Faculty</b>		
FHPK	276	76.2
FKP	53	14.6
FPV	33	9.1
<b>Semester</b>		
1	2	0.6
2	18	5.0
3	14	4.1
4	50	13.8
5	29	8.0
6	232	64.1
7	11	3.0
8	6	1.7
<b>The frequency of respondents attending wellness programs or activities at Universiti Malaysia Kelantan City Campus.</b>		
Everyday	27	7.5
Not sure	81	22.4
Several times a month	152	42.0
Several times a week	102	28.2

Table 1 shows the result of frequency analysis of respondents. The research focuses on students and staffs in UMK City Campus. There are 108 respondents (29.8%) of male respondents compared to the female respondent which is 254 respondents (70.2). The reason why the female respondent is more than male respondent is because the female respondent is easy to approach, and they are willing to spend their time answering the questionnaire. The majority of respondent were from age of 22 – 25 years old which is 301 respondents (83.1). The second highest is 18 – 21 years old with 29 respondents (8.0%), while the respondent from aged 26 – 29 years old is 25 respondents (6.9%). Lastly, the age group from 30 years and above is 7 respondents (1.9%). The reason why the age group of 22 to 25 years has the highest percentage is that they are among the first to third-year students of the UMK City Campus. Meanwhile, the age of 30 years and above is the lowest because it is likely from among the staff of the UMK City Campus. Next, there are huge differences between single and married couples, with single scores the highest 333 respondents (92.0%) and respondents who are married 29 respondents (8.0%). Most of the respondents are from Malay which is 307 respondents (84.8%), followed by Chinese which is 29 respondents (8.0%), Indian is 23 respondents (6.4%) and others is 3 respondents (0.8%). The data shows that there are more

ethnic Malays who answered this questionnaire because the majority of students at UMK City Campus are ethnic Malays.

Respondents from students is the highest percentage which is 331 respondents (91.4%). Then followed by staff which is 31 respondents (8.6%). There are more students who answer the questionnaire than staff because students have more time than staff. Furthermore, respondents from FHPK students showed the highest which is 276 respondents (76.2%). Then followed by FKP which is 53 respondents (14.6%) and last but not least are FPV students which is 33 respondents (9.1%). Next, respondents from semester 6 students showed the highest which is 232 respondents (64.1%). Then followed by the second highest semester 4 which is 50 respondents (13.8%) and then semester 5 the third highest which is 29 respondents (8.0%). Next, the fourth highest in semester 2 which is 18 respondents (5.0%). The fifth highest is semester 7 which is 11 respondents (3.0%) followed by semester 8 which is only 6 respondents (1.7%) and finally semester 1 which only gets 2 respondents (6%). Finally, majority the frequency of respondents attending wellness programs or activities at Universiti Malaysia Kelantan City Campus for several times a month shows the highest which is 152 respondents (42.0%). Next, 102 respondents (28.2) for the frequency of several times a week. Then, the frequency of respondents attending wellness programs or activities at the UMK City Campus that is uncertain or not sure is as much as 81 respondents (22.4%) and finally, every day that attends wellness programs or activities at the UMK City Campus is as much as 27 respondents (7.5%).

### Result of the Descriptive Analysis

Table 2 shows the result of descriptive analysis of variables.

Table 2: Descriptive Analysis of Variables

Variables	Items	Mean	Standard Deviation
<b>Motivation</b>	I am not taking part in the wellness initiative programs because it can't improve my health.	1.79	962
	I am not taking part in the wellness initiative programs because it can't increase my productivity.	1.83	917
	I am not taking part in the wellness initiative programs because it can't improve my engagement with my friends.	2.36	989
	I am motivated to join wellness program.	4.02	1.040
	I am not taking part in the wellness initiative programs because it can't reduce my stress levels.	2.10	1.087
	I am not taking part in the wellness initiative programs because it can't improve teamwork.	2.75	1.282
<b>Leadership support</b>	The faculty management and student representative council are not always taking part in the planning of wellness programs.	2.39	1.198

	The faculty management and student representative council are not always taking part in organizing wellness programs.	2.36	1.265
	The faculty management and student representative council does not make wellness programs an important agenda in faculty or students' programs.	2.78	1.384
	The faculty management and student representative council does not encourage the staffs and students to take part in wellness programs.	2.10	1.081
	The faculty management and student representative council do not have a clear objective for faculty or students' wellness programs.	2.34	1.223
	The faculty management and student representative council does not always promote the importance of wellness programs.	2.60	1.320
<b>Participant Awareness</b>	I didn't know that participating in campus wellness initiatives programmes can improve my health.	2.24	1.146
	I am not aware that by participate in campus wellness initiative programs can increase my productivity.	2.35	1.216
	I didn't know that participating in campus wellness initiative programs can improve my engagement with my friends.	2.52	1.114
	I am not aware that participating in wellness initiative programs can improve my engagement with my friends.	2.41	1.270
	I am not aware that participating in wellness initiative programs can reduce my stress levels.	2.44	1.297
	I am not aware that participating in wellness initiative programs can improve teamwork.	2.64	1.169
<b>Participant Interest</b>	I am not interested in participating in wellness initiative programs if it is organized during the weekend.	1.88	1.059



	I am not interested in participating in wellness initiative programs if it is organized after the lecture/ working hours.	2.42	1.313
	I am not interested in participating in wellness initiative programs if it is conducted by external expertise.	1.99	1.034
	I am not interested in participating in wellness initiative programs if it is conducted by the faculty management/ student representative.	2.21	1.190
	I am not interested in participating in wellness initiative programs if it is conducted in a simple form.	2.15	1.124
	I am not interested in participating in wellness initiative programs if it is conducted in a fun way.	2.01	1.094
<b>Facilities</b>	The facilities for the wellness initiative programs provided by the university are not satisfactory.	3.29	1.222
	The facilities for the wellness initiative programs provided by the university are low.	3.50	1.187
	The facilities have not become the main factors to initiate wellness initiative programs at the university/ faculty level.	3.54	1.133
	Inadequate facilities can lower the number of participants joining the wellness initiatives programmes at the faculty/ university level.	3.44	1.125
	Staff/ students should have not been informed about the facilities provided at the university/ faculty level to attract more participants to join the campus wellness initiative programs.	2.82	1.419
	There is a need to improve the wellness facility in the campus area.	4.22	1.020
<b>Level of The Initiatives Effectiveness</b>	Each wellness initiative programs I participated in has not defined the desired outcomes.	2.27	1.190

Each wellness initiative programs I participated in do not mention clear goal of a healthy and well-being lifestyle.	2.28	1.262
All of the wellness initiatives programmes are complicated to participate.	2.09	1.150
There are more than 5 wellness initiatives programmes conducted every semester.	2.81	1.336
Staff and students are not well informed about the wellness initiatives programmes conducted in the university/ faculty.	2.62	1.380
I am not satisfied with the wellness initiatives programs conduct in the university/ faculty level.	2.51	1.264
The wellness initiatives programmes schedule is not flexible.	2.46	1.207
The wellness initiatives programmes that I join has not benefited me.	2.12	1.199

Table 2 shows the result of descriptive analysis of variables. For the first of independent variable is motivation which is the item is “I am motivated to join wellness program” has the greatest mean score (M=4.02, S.D=1.040). The next variable is leadership support which is the item that has the greatest mean score is “The faculty management and student representative council does not make wellness programs an important agenda in faculty or students’ programs”, (M=2.78, S.D=1.384). The item for participant awareness that has the greatest mean (M=2.64, S.D=1.169) is “I am not aware that participating in wellness initiative programs can improve teamwork”. Besides, the fourth independent variables is participant interest and the items is “I am not interested in participating in wellness initiative programs if it is organized after the lecture/ working hours” which is (M=2.42, S.D=1.313). Lastly, for independent variables is facilities which is the greatest mean score (M=3.54, S.D=1.133) that the item is “The facilities have not become the main factors to initiate wellness initiative programs at the university/ faculty level”. Meanwhile, for dependent variable is level of the initiatives effectiveness which is the item is “There are more than 5 wellness initiatives programmes conducted every semester” has a greatest mean score (M=2.81, S.D=1.336).

### Results of Reliability Analysis

Table 3 shows the result of reliability analysis based on independent variables and dependent variable.

Table 3: Reliability Analysis

Variables	Number of Items	Cronbach’s Alpha
Motivation	6	.733
Leadership Support	6	.900

Participant Awareness	6	.885
Participant Interest	7	.897
Facilities	6	.798
Level of The Initiatives Effectiveness	8	.923

Table 3 shows the result of the reliability analysis based on each independent variables and dependent variable. The first independent variables are motivation with 6 questions shows Cronbach's Alpha value of .733 which is acceptable. The second independent variable, leadership support which contains 6 questions shows the Cronbach's Alpha value .900 which the level is excellent so that the question is strength and high positive. The third is participant awareness also within 6 question and the Cronbach's Alpha is .885 with good of internal consistency level. Next, participant interest which is have 7 questions and the Cronbach's Alpha is .897 with the good result. The last for independent variable is facilities that have 6 questions and the result is .798 with the acceptable result. Meanwhile, in measuring dependent variable, the researcher provides 8 questions and the result of Cronbach's Alpha is .923 with the excellent result.

### Result of Pearson Correlation Analysis

Table 4 shows the result of Pearson Correlation analysis based on the hypothesis.

Table 4: Pearson Correlation Analysis

Hypothesis	P-Value	Result
<b>H1:</b> A moderately positive correlation between the motivation among student and the effectiveness of the wellness initiatives.	0.01	Supported
<b>H2:</b> A moderately positive correlation between the leadership support and the effectiveness of wellness initiatives effectiveness.	0.01	Supported
<b>H3:</b> A moderately positive correlation between participant awareness and the effectiveness of wellness initiatives.	0.01	Supported
<b>H4:</b> A strong positive correlation between the participant interest and the effectiveness of wellness initiatives.	0.01	Supported
<b>H5:</b> A weak negative correlation between the facilities and the effectiveness of wellness initiatives.	0.05	Not Supported

Table 4 shows the result of Pearson Correlation analysis based on the hypothesis. According to the results, the significant p-value of H1 is 0.01 which is the p-value is under 0.05. Thus, the study can reject the null hypothesis. The Pearson Correlation result is 0.458 stipulates the strength of the relationship between motivation and the effectiveness of wellness initiatives is moderate and the result is supported. Next, the significant p-value of H2 is 0.01 which is the study can reject the null hypothesis. The Pearson Correlation

result is 0.692 stipulates the strength of the relationship between leadership and the effectiveness of wellness initiatives is moderate correlation and the result is supported. Then, the third hypothesis which is H3, the significant value is 0.01 that the p-value is under 0.05. The study can reject the null hypothesis. The result shows moderate correlation with a correlation coefficient value of 0.666 that has a supported result between participant awareness and the effectiveness of wellness initiatives. The last result that the p-value is under 0.05 is H4 which is the study can reject the null hypothesis. That is strong correlation between participant interest and the effectiveness of wellness initiatives. Lastly, H5 shows that negligible correlation with a correlation coefficient value of -.023. The p value of the facilities with the level of effectiveness of wellness initiatives is 0.662 which is the result is not supported at p-value, that is more than 0.05. Thus, the study is not statistically significant and the null hypothesis is not rejected.

## **DISCUSSION AND RECOMMENDATIONS**

Discussion is aimed at solving questions and addressing hypothesis as mentioned in first chapter of this study. To improve the study and gather more useful data, some recommendations are made. In general, the researcher can conduct in-person interviews or use an online platform to assure the effectiveness of this study. This entails distributing a Google form for responders to complete in exchange for an in-person interview. This is done to make it simpler for researchers to quickly and easily gather information that is more focused. It might expedite research even more.

The researcher needs to decide which respondents to interview in more detail at first. They must be directly related to the subject of the study because if the respondent is familiar with it, it may facilitate the search for relevant material and be faster. If the respondents have a clear understanding of the research topic, it may help to collect respondent data more accurately and fast. Finding the appropriate target respondents for the study is practical on the part of the researcher because problems may arise when the target respondents do not understand the given research topic clearly and it can make it complicated for the researcher to complete the future studies.

Next, to ensure that the findings of the study are fair and focused, the next researcher needs to focus on the target group of respondents which includes UMK City Campus staff and students. The expected results should be compatible with the title of the study, which is to identify the challenges and the level of effectiveness of campus well-being initiatives among students and staff at UMK City Campus. Based on the data results, it can be used as knowledge provided to students and staff at UMK City Campus to find out about work and study experiences while in such a situation.

Finally, when planning future investigations, researchers may consider other variables through perspective. The variables in this study that only have moderate relationship with the dependent variable which is motivation, participant awareness, participant interest, leadership support, and convenience.

## **CONCLUSION**

In conclusion, the study has been accomplished to identify the challenge and the level of effectiveness of campus wellness initiatives among students and staffs in UMK City Campus. This study is focused on the relationship between five independent variables known as motivation, leadership support, participant interest, participant awareness and facilities and one dependent variable which is level of initiatives of effectiveness. A total of respondents for this study among students and staffs in UMK City Campus to examine their effectiveness in wellness initiatives. In short, according to the results, all independent variables are moderately positive and correlated with the dependent variable except facilities variables. In summary, the objective of the study has been achieved which is to identify the level of effectiveness of campus wellness initiatives among students and staff in UMK City Campus.

## REFERENCES

- Academy, W. (2021, June 13). Importance of Wellness Programs in Schools for Students. Walkertown Academy. <https://www.walkertownacademy.com/importance-of-wellness-programs-in-school/>
- Akter, M., Sadekin, M. N., & Patwary, A. K. (2020). An Empirical Study on Students' Satisfaction from Mawlana Bhashani Science & Technology University, Bangladesh. *Review of Economics and Development Studies*, 6(2), 363-379.
- Aldana, D. S. (2020, January 2). *The 7 Best Reasons to Have a Wellness Program: Benefits of Wellness*. Employee Wellness Programs. <https://www.wellsteps.com/blog/2020/01/02/reasons-to-have-a-wellness-program-benefits-of-wellness/>
- Alom, S., Patwary, A. K., & Khan, M. M. H. (2019). Factors affecting the turnover intention of Bangladeshi migrants in the United Arab Emirates: An empirical study on the hotel industry. *International Journal of Innovation, Creativity and Change*, 8(3), 344-360.
- Benefits of wellness program for student in the school*. (2020, July 20). <https://www.sudhirmemorialinstituteliluah.com/benefits-of-wellness-program-for-student#:~:text=It%20gives%20us%20physical%20strength>
- Cherry, K. (2022, May 23). *Motivation: Psychological factors that guide behaviour*. Verywell Mind. <https://www.verywellmind.com/what-is-motivation-2795378>
- Christianson, J., Kattelman, K., Moret, L., Riggsbee, K., Vilaro, M., Olfert, M. D., Mathews, A., Barr, M., & Colby, S. (2018). College Campus Wellness Programs: Identifying and Addressing the Health Needs of College Students. *Journal of Nutrition Education and Behavior*, 50(7), S110. <https://doi.org/10.1016/j.jneb.2018.04.146>
- Ewing, B., Ryan, M., & Zarco, E. P. (2007). A campus wellness program: accepting the challenge. *The Journal of the New York State Nurses' Association*, 38(1), 13–16. <https://pubmed.ncbi.nlm.nih.gov/17941614/>
- Fengmin, Z., Baijun, W., Jiangtao, B., Li, L., & Patwary, A. K. (2022). Investigating revisit intention of medical tourists in China through nutritional knowledge, perceived medical quality, and trust in the physiologist: A recommendation on health tourism policy measures. *Frontiers in Public Health*, 10, 893497.
- Hazbar, A. M. H., Alem Mohammed, A., & Karim, A. K. A. (2019). An Empirical Study of Factors Influencing hotel customers' online booking Intention. *مجلة العلوم التربوية و الدراسات الإنسانية*, (5), 1-17.
- Health Direct. (2018, March 9). *Motivation: How to get started and staying motivated*. Healthdirect.gov.au; Health direct Australia. <https://www.healthdirect.gov.au/motivation-how-to-get-started-and-staying-motivated>
- Li, L., Ragavan, N. A., Patwary, A. K., & Baijun, W. (2022). Measuring patients' satisfaction toward health tourism in Malaysia through hospital environment, nutritional advice, and perceived value: A study on Chinese exchange students. *Frontiers in public health*, 10, 893439.
- Li, L., Wu, B., & Patwary, A. K. (2022). How marine tourism promote financial development in sustainable economy: new evidences from South Asia and implications to future tourism students. *Environmental Science and Pollution Research*, 29, 1155-1172.

- Li, L., Wu, B., & Patwary, A. K. (2022). The psychosocial factors affecting chinese Outbound Exchange and mobility students' academic performance during COVID-19. *Frontiers in psychology*, 13, 872516.
- Lowe, E. (2019, May 26). *The importance of supportive leadership*. Think Forward Consulting - Business Development; Think Forward Consulting - Business Development. <https://thinkforwardconsulting.co.uk/the-importance-of-supportive-leadership/>
- Patwary, A. K., Roy, B., Hoque, R., & Khandakar, M. S. A. (2019). Process of developing a community based tourism and identifying its economic and social impacts: An Empirical study on Cox's Bazar, Bangladesh. *Pakistan Journal of Humanities and Social Sciences*, 7(1), 1-13.
- Pfizer. (2022). What is Wellness? | Pfizer. [www.pfizer.com. https://www.pfizer.com/health-wellness/wellness/what-is-wellness](https://www.pfizer.com/health-wellness/wellness/what-is-wellness)
- Popirtac, F. (2021, August 25). Why is Student Wellbeing important? SPARK. <https://spark.school/why-is-student-wellbeing-important/>
- Popirtac, F. (2021, August 25). *Why is Student Wellbeing important?* SPARK. <https://spark.school/why-is-student-wellbeing-important/>
- Rise Staff. (2019, July 3). 6 Great Examples of Workplace Wellness Programs. Rise; Rise. <https://risepeople.com/blog/workplace-wellness-programs/>
- Rose, A., Khullar, L., & Zettervall, A. (n.d.). *Developing University Wellness Programs ULEAD 2017*. <https://hr.unc.edu/wp-content/uploads/sites/222/2017/12/Developing-University-Wellness-Programs-ULEAD-2017.pdf>
- Student Wellness: Action Plan*. (n.d.). Division of Student Life. Retrieved December 5, 2022, from <https://studentlife.uiowa.edu/departments/air/improvement/departmental-program-review/action-plan/student-wellness-action-plan/>
- Sumethokula, P., Patwary, A. K., Srinuanpanc, B., Srinuanpand, C., Suwandee, P., Thammathikul, A., & Phanong, W. (2020). The potential of new tour repackaging for creative tourism among entrepreneurs in Nakhon Si Thammarat. *International Journal of Innovation, Creativity and Change*, 13(10), 1752-1771.
- True Purpose of Employee Wellness Programs*. (n.d.). [www.lark.com. Retrieved December 5, 2022, from https://www.lark.com/resources/true-purpose-of-employee-wellness-programs](https://www.lark.com/resources/true-purpose-of-employee-wellness-programs)
- Williams, L. (2019, May 29). *What Is Zumba?* Verywell Fit; Verywell Fit. <https://www.verywellfit.com/zumba-pros-cons-and-how-it-works-4688722>
- Wu, B., Liu, S., Wang, J., Tahir, S., & Patwary, A. K. (2021). Assessing the mechanism of energy efficiency and energy poverty alleviation based on environmental regulation policy measures. *Environmental Science and Pollution Research*, 28, 40858-40870.
- Wu, B., Zhai, B., Mu, H., Peng, X., Wang, C., & Patwary, A. K. (2021). Evaluating an economic application of renewable generated hydrogen: A way forward for green economic performance and policy measures. *Environmental Science and Pollution Research*, 1-15.

# ASSESSING THE POST-SERVICE EXPERIENCE TOWARDS EMOTIONAL IMPACTS ON SPA-GOERS IN KOTA BHARU, KELANTAN

*Intan Nur Qistina Binti Alias, Siti Nor Asuha Binti Razali, Nurul Shapiqah Binti Sobri, Rabiatul Adawiah Binti Badrol & \*Ahmad Faezi Ab Rashid*

*Faculty of Hospitality, Tourism and Wellness, University Malaysia Kelantan  
Corresponding email: faezi.ar@umk.edu.my*

---

## **ABSTRACT**

**Introduction:** The wellness market in Malaysia expanded by 10% in 2014, and the government wants to expand the spa business to draw tourists who have the cash and desire to spend on opulent experiences. A spa is a highly prudent investment for hotel owners. It is the ideal enhancement to the services that may be offered to hotel guests, but it could also make spa services available to residents to make extra money. The research aims to identify the spa post-service experience of reliability, assurance, empathy, and responsiveness toward the emotions of spa customers. **Method:** Cross-sectional study design was applied in the present study. The data were collected from 218 Spa Customers respondents in Kota Bharu, Kelantan. The data collection was conducted through a structured questionnaire using Google Forms. A pilot study was conducted with 30 spa customers before distributing questionnaires in the full-scale cross-sectional study. The data were analysed with Statistical Package for Social Sciences (SPSS) data analysis software. Descriptive analysis and Pearson correlation coefficient were used to analyse the data. **Result:** The Pearson correlation values for the reliability, assurance, empathy, and responsiveness towards the emotions of Spa Customers ranged from 0.80 to 0.91. **Conclusion:** Effective post-Service Spa Experience Activities can attract customers' interest to seek treatment at the Spa.

**Keywords:** *Assessing the Post-Service Experience of Spa on Emotional, Spa Customer, Reliability, Assurance, Empathy*

---

## **INTRODUCTION**

The spa industry has evolved away from including water and has become more associated with the wellness sector by advocating that holistic well-being is crucial in the spa environment. Beyond material prosperity, holistic well-being encompasses many other factors. The pursuit of material money and belongings does not bring long-term fulfilment and contentment. Instead, it makes people feel unhappier,

depressed, anxious, angry, lonely, and alienated (Kasser, 2002; Eckersly, 2005). Thus, holistic well-being is the inner happiness, peace, and balance between body, mind, and soul.

The research shows that Pilzner (2002) has the wellness revolution successfully encapsulated this new commercial phenomenon. He emphasizes how the wellness industry differs from the traditional healthcare sector and sees wellness as an industry rather than a philosophy. Additionally, he views the wellness industry as proactive, with healthy individuals choosing to become clients in order to feel better, slow down the impacts of aging, and prevent becoming sick people's customers.

Consumption emotion is a person's emotional response to a good or service (Richins, 1997). Two dimensions that present a person's experience of emotions are positive and negative (Diener, 1999). The consumption emotion scale is considered superior to other emotional measurement scales. Cognition is one of the precursors of consumer emotion. Most of the time, service quality evaluation has been seen as a cognitive activity. The five characteristics of tangible, dependability, responsiveness, certainty, and empathy are used to determine whether a product or service is superior worldwide by consumers.

Hence, this study focuses on the post-service emotional element: lifestyle, stress, and mobile phone use among spa visitors in Kota Bharu, Kelantan. People would gain a new understanding as a result of the investigation and analysis that went into this research method.

This study consists of four objectives:

1. To determine the relationship between reliability and emotional impact on spa customers in Kota Bharu, Kelantan.
2. To determine the relationship between assurance and emotional impact on spa customers in Kota Bharu, Kelantan.
3. To determine the relationship between empathy and emotional impact on spa customers in Kota Bharu, Kelantan.
4. To determine the relationship between responsiveness and emotional impact on spa customers in Kota Bharu, Kelantan.

## **SIGNIFICANCE OF THE STUDY**

### **Academic Contribution**

This consider looked at how customers survey the potential esteem of their spa involvement and get it the variables that impact participation and enduring devotion. The objective of this think about was



to examine how two particular characteristics of seen value—the work score and prosperity score—affect future conduct among spa clients. Based on the system of 'Quality – Seen Esteem – Fulfilment – Behavioural Intention', a field think about was conducted to test the intervening part of useful esteem and wellbeing esteem within the case of spa clients in Kelantan. This result gives more data to clarify the basic instruments that increment spa customers' behavioural purposeful to return and prescribe.

### **Managerial Implication**

The expanding use of advertising within the encounter economy makes the significance of this study clear. According to McNeil and Ragins (2005), the rapidly growing spa benefit industry is what is fuelling this intrigue. To understand the usage sentiment, perceived value, and behavioural eagerness of spa patrons, however, has received only cursory attention. Once the connection between benefit quality, utilization feeling, seen esteem, and behavioural deliberate is understood, spa administrators can use the knowledge to plan appropriate services to draw in customers; marketers can plan the engagement to strengthen utilization feeling and make seen esteem. The competitiveness of spa providers is increased by a strong utilization experience plan, which results in greater benefits.

## **LITERATURE REVIEW**

### **EMPATHY**

Empathy gives careful and individual attention to the client. It includes the following characteristics: accessibility, a sense of security and an effect of understanding the needs of the client. In contrast, empathy is described as the caring and personal care that a company provides to its customers. The essence of empathy is to let customers know that they are unique and special and that their needs are understood through tailored or personalized service. Customers want to feel understood and important by the companies that provide them with services. The purpose of this study is to find out how many tourists believe that the quality of spa services meets their expectations. A customer-centric strategy that starts with empathy being emotionally intelligent. In the healthcare industry, the idea of emotional value is widely accepted and used. Many welfare providers agree that success and effectiveness involve an emotional strategy (Narendra, 2017).

### **RESPONSIVENESS**

In the spa market and industry, responsiveness refers to Spa's staff or management's ability to provide prompt service. A previous survey of resort and hotel Spa customers in Kota Bharu, Kelantan

showed that responsiveness was the most important determinant factor in explaining positive emotions (Lo, Wu, & Tsai, 2015). They may not fully understand the protocol and methodology of spa treatments, especially for infrequent visitors, and they heavily depend on the therapists to educate and inform them (Lo et al., 2013). Furthermore, spa service should be well-designed to anticipate the right moment to provide the right service to the customers. Customers should not feel ignored or kept waiting for too long. The service should be so subtle that whenever a customer needs something, someone is there to help them (Lo et al., 2013).

## **ASSURANCE**

Assurance was also shown to be statistically significant with respect to customer satisfaction, a result similar to previous studies by Omar et al. (2021) believes that security is one of the salient aspects of service quality characteristics that he believes lead to customer satisfaction. Staff knowledge and courtesy are essential to instill confidence in spa customers. Customers expect companies to be industry leaders in the services they provide. It gives customers a sense of security that "this spa is reliable". It also leads to positive word of mouth and customer testimonials. That probably justified the find. Quality of service attributes influence spa-goer satisfaction. Interestingly, from a Malaysian perspective, the results indicate that trustworthiness, safety, and empathy attributes are the factors that most influence satisfaction with spa facilities. Most respondents want reassurance from spa providers that they can use all spa facilities and feel safe, especially when it comes to privacy. In addition, spa-goers want to be served according to their preferences. Finally, spa providers need to know about the well-being of their customers and the spa industry. An article by Mohammad et al. (2021) endorses the statement that the spa industry needs to reinvent itself to remain relevant.

## **RELIABILITY**

Reliability refers to the likelihood of a product or system performing its intended function satisfactorily for a predetermined period of time, or of operating in a predetermined environment without malfunctioning. It also refers to the organization's readiness to address any issues that arise, as well as its ability to provide prompt service. Reliability Spa Service has been a certified pool/spa operator (CPO) for 13 years, and we are proud to offer friendly, experienced hot tub advice, as well as expert service and repair. We repair virtually all makes and models of hot tubs available in southern Ontario, from pump and electronic repair to full spa re-maintenance and conditioning. It is important to note that small improvements do not necessarily indicate the effectiveness of a therapy, as they may be the result of

experimental error, rather than treatment itself. This is evidenced by Chea (2022), which found that reliability was statistically significant in terms of customer satisfaction.

### Research Hypothesis

This study has four hypotheses, that are related to identifying the relationship between reliability, assurance, empathy, and assurance toward spa customers' emotions.

H1: There is a significant relationship between reliability and emotional impact on spa customers in Kota Bharu, Kelantan.

H2: There is a significant relationship between assurance and emotional impact on spa customers in Kota Bharu, Kelantan.

H3: There is a significant relationship between empathy and emotional impact on spa customers in Kota Bharu, Kelantan.

H4: There is a significant relationship between responsiveness and emotional impact on spa customers in Kota Bharu, Kelantan.

### Research Framework

There are four independent variables (IV) which are the reliability, assurance, empathy, and responsiveness among spa customers in Kota Bharu, Kelantan. The emotion of spa customers is a dependent variable (DV). This research intends to study the effect of service quality on spa customers' emotions in Kota Bharu, Kelantan. The conceptual framework of research is as follows:

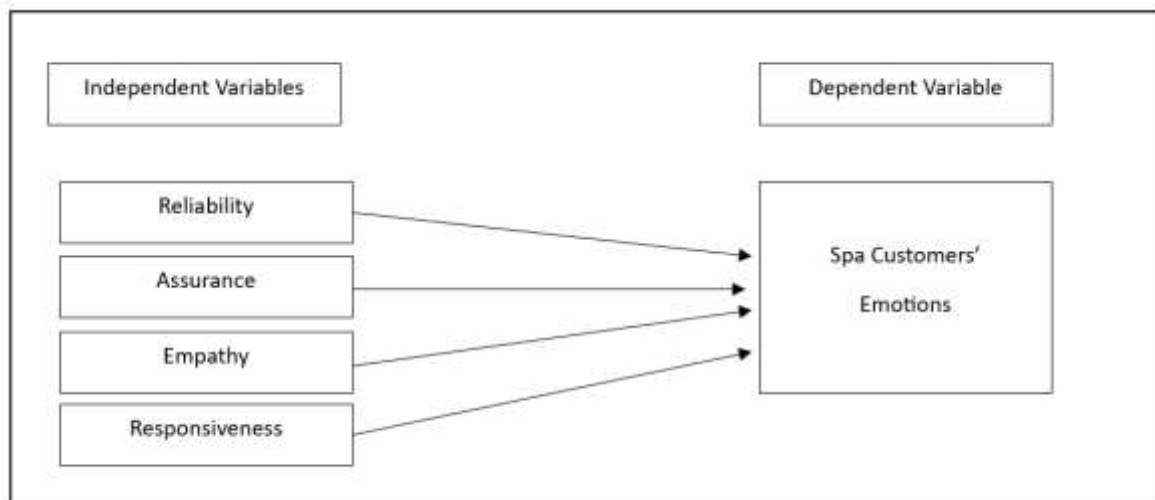

Figure 1: Conceptual Framework

## **METHODOLOGY**

### **Research Design**

The most suitable research approach adopted in this study is a quantitative method using survey research. Data will be collected from a sample of spa customers in Kota Bharu, Kelantan. This study focuses on spas in Kota Bharu to facilitate the researcher's data collection.

### **Data Collection**

Quantitative data collection using questionnaires via Google Forms and questionnaires distributed to spa guests who visit spa in Kota Bharu, Kelantan to get the answer to the questionnaire check. There, 218 responses were collected from repliers who answered all the check questions.

### **Sampling Method**

The sample size for all spa customers in Kota Bharu, Kelantan, was selected with a total population of 500 respondents. A total of 218 respondents were selected as respondents in this study. The researcher used simple random sampling as the sampling design for this study. Simple random sampling is a type of probability sampling in which respondents have a chance to be selected as s sample. It only takes a short time to get the data, it is relatively expensive, and respondents are easily available at the right place and time.

### **Data Analysis**

Data is collected and analysed through survey forms. After data collection, all collected data were analysed using the IBM Statistical Package for Social Science (SPSS) version 26. Analytical methods for research are divided into several methods such as data analysis, descriptive statistics, reliability tests, and Pearson correlation. Researchers focus on the independent variables that influence the difficulty of Kota Bharu's spa customer program through questionnaire responses.

## **FINDINGS**

### **Demographic Profile of Respondents**

Table 1 below shows the frequency analysis of this research.

Table 1: Respondents' Socio-Demographic Profile (N=218)

---

Demographic profile characteristic	Frequency	Percentage (%)
	1821	

Sex	Male	35	16.1
	Female	183	83.9
Race	Malay	196	89.9
	Chinese	13	6.0
	Indian	9	4.1
Religion	Muslim	199	91.3
	Christian	9	4.1
	Buddha	8	3.7
	Others	2	0.9
Age range	20 – 24 years	116	53.2
	25 – 29 years	37	17
	30 – 34 years	24	11
	35 – 39 years	14	6.4
	40 - 44 years	11	5.0
	45 – 49 years	8	3.7
	50 and above	8	3.7

Table 1 shows the descriptive statistics of the respondent's demographic profile. The table indicates that the total number of respondents in this survey is 218. The total number of male respondents was 35 (16.1%), while 183 (83.9%) were female respondents. This shows that more female respondents answered the survey than male respondents.

There are three main different races in this survey. The highest number of respondents was Malays, consisting of 196 respondents with a value of 89.9 percent. The lowest are from Indian, with 9 respondents with a value of 4.1 percent. The Malay respondents answer the questionnaire mainly because a majority of people in Kelantan are Malays. Furthermore, there are four main different religions in this survey. The highest number of religions which has responded to this questionnaire was the Muslim religion, with a frequency of 199 respondents with a value of 91.3 %, whereas the lowest was respondents from the other religion, with a frequency of 2 respondents and 0.7%. Most of the respondents come from young adults (22 years old) compared to other age groups.

Section B in the questionnaire shows different variables of customer emotions toward the spa, such as satisfaction with the spa visited, spa treatment or services used, and emotion after visiting the spa.

## Descriptive Analysis

Table 2 below shows the descriptive analysis for the independent variable, reliability, assurance, empathy, responsiveness, and dependent variable spa customers' emotions.

Table 2: Descriptive Analysis

Variable	Items	Mean Score	Standard Deviation
Reliability	When the therapist confirms the appointment at a certain time, they will perform the treatment as prescribed.	4.26	0.819
	The therapist is dependable.	4.15	0.878
	The therapist can explain the charges for services clearly.	4.15	0.851
	The spa keeps customer records confidentially.	4.15	0.954
	When a customer has a problem, the therapist shows sincerity to solve the problem.	4.20	0.849
Assurance	The spa is always clean.	4.28	0.870
	The products used are of good quality (natural ingredients or trustworthy brands).	4.28	0.837
	The environment of the spa is safe.	4.27	0.844
	The spa provides proper changing facilities.	4.33	0.886
	Spa management shall take all reasonable measures to ensure the security of customers and their possessions during their time at the spa.	4.41	0.823
Empathy	The therapist knows what the customers' needs are.	4.27	0.861
	Treatment at the spa has its own charm.	4.27	0.898

	The spa operates at a convenient time for customers to receive treatment.	4.32	0.851
	The spa offers a variety of treatments to suit the customer's needs.	4.37	0.823
	The service received from the therapist was very satisfactory.	4.30	0.836
Responsiveness	The therapist deliver prompt service to customers.	4.27	0.903
	The therapist is always willing to help customers.	4.33	0.831
	The therapist explained the types of service provided clearly.	4.34	0.862
	The therapist is never too busy to respond to customer requests.	4.08	0.999
	The therapist is professional in providing the service.	4.31	0.892
Spa Customers	I felt calm after the treatment.	4.40	0.793
Emotional	I felt secure at the spa.	4.32	0.812
	I felt comfortable with their treatment.	4.39	0.767
	I felt excited at the spa.	4.33	0.837
	I felt satisfied with their treatment.	4.39	0.831

The first item in the independent variable of reliability is “When the therapist confirms the appointment at a certain time, they will perform the treatment as prescribed,” which has a mean of 4.26 (SD=0.819). “The therapist is dependable” is the second item. It has the same mean as items “The therapist can explain the charges for services clearly and “The spa keeps customer records confidentially,” which are 4.15.

Furthermore, the first item in the independent variable of Assurance is, “The spa is always clean” has a mean of 4.28 (SD=0.870). The second item is “The products used are of good quality (natural

ingredients or trustworthy brands) has a mean also 4.28 (SD=0.837). “The environment of the spa is safe” has the lowest mean of 4.27 (SD=0.844). The fourth item, “The spa provides proper changing facilities” has a mean of 4.33 (SD=0.886). “Spa management shall take all reasonable measures to ensure the security of customers and their possessions during their time at the spa” is the fifth item with the highest mean, 4.41 (SD=0.823).

Besides that, the first item in the independent variable of empathy is “The therapist knows what the customer needs are”. It has the lowest mean of 4.27 (SD=0.861). The second item, “Treatment at the spa has its own charm” has the same mean of 4.27 (SD=0.898). The third item, "The spa operates at a convenient time for customers to receive treatment, " has a mean of 4.32 (SD=0.851). The item “The spa offers a variety of treatments to suit the customer’s needs” is the highest mean of 4.37 (SD=0.823). The fifth item, "The service received from the therapist was very satisfactory, " has a mean of 4.30 (SD=0.836).

In addition, the first item in the independent variable of responsiveness, “The therapist delivers prompt service to customers” has a mean of 4.27 (SD=0.903). “The therapist is always willing to help customers” is the second item of responsiveness, with a mean of 4.33 (SD=0.831). The third item, "The therapist explain the types of service provided clearly” has the highest mean of 4.34 (SD=0.862). The fourth item, "The therapist are never too busy to respond to customer requests” has the lowest mean, which is 4.08 (SD=0.999). The fifth item is “The therapist is professional in providing the service”. It has a mean of 4.31 (SD=0.892).

Other than that, the first item in the dependent variable of spa customer emotion is “I felt calm after treatment”. This item has a mean of 4.40 (SD=0.793), which is at the strong agree level. The second item is “I felt secure at the spa”. It has the lowest mean of 4.32 (SD=812), which is at the strong agree level. The third item is “I felt comfortable with their treatment” with a mean of 4.39 (SD=7.67). “I felt excited at the spa” is the fourth item of Spa customer emotion. It has a mean of 4.33 (SD=0.837). The fifth item, “I felt satisfied with their treatment” has a mean of 4.39 (SD=0.831).

## Reliability Analysis

### Result of Reliability Analysis

Table 3 below shows the reliability analysis of this research.

Table 3: Reliability Analysis

Variable	Number of Items	Cronbach Alpha
Reliability	5	0.933
Assurance	5	0.950



<b>Empathy</b>	5	0.956
<b>Responsiveness</b>	5	0.949
<b>Spa Customers Emotional</b>	5	0.970

Table 3 above demonstrates the reliability of 5 variables. Cronbach's Alpha turned into used to observe the reliability of the 25 gadgets and used to degree the 5 constructs. In addition, the effects in Table 4.6 display that the reliability of every assemble stages from 0.933 to 0.949. All the variables have been above the cost of 0.7. As an end result of the pilot test, the general end result turned into acceptable. According to the effects, spa client emotion has the best coefficient of 0.970, even as reliability has the bottom coefficient of 0.933.

### **Result of Pearson Correlation Analysis**

Table 4: Pearson Correlation Analysis Result

<b>Hypothesis</b>	<b>P-Value</b>	<b>Result</b>
<b>H1: There is a significant relationship between reliability and emotional impact on spa customers in Kota Bharu, Kelantan.</b>	0.001	H1 is accepted
<b>H2: There is a significant relationship between assurance and emotional impact on spa customers in Kota Bharu, Kelantan.</b>	0.001	H2 is accepted
<b>H3: There is a significant relationship between empathy and emotional impact on spa customers in Kota Bharu, Kelantan.</b>	0.001	H3 is accepted
<b>H4: There is a significant relationship between responsiveness and emotional impact on spa customers in Kota Bharu, Kelantan.</b>	0.001	H4 is accepted

Table 4 shows the result of Pearson correlation analysis based on the hypothesis. According to results, the significant p-value of H1 is 0.001 which is below 0.05. Thus, the study can reject the null hypothesis. There is significant relationship between reliability and post-service spa customers' emotions. And it made hypothesis is accepted. Next, the significant p-value of H2 is 0.001 which is below 0.05 and the p-value is under 0.05. There is a significant relationship between assurance and post-service spa

customers' emotions, and the hypothesis is accepted. In addition, the significant p-value of H3 is 0.001 which is below 0.05 and the p-value is under 0.05. There is significant relationship between empathy and post-service spa customers' emotions, and the hypothesis is accepted. Lastly, the significant p-value of H4 is 0.001 which is below 0.05 and the p-value is under 0.05. There is significant relationship between responsiveness and post-service spa customers' emotions, and it was hypothesis accepted.

## **DISCUSSION AND RECOMMENDATION**

### **Discussion on Hypothesis 1**

Reliability is the capacity to offer the promised carrier reliably and accurately. In an extensive sense, reliability manner that the organisation promises on its guarantees concerning the availability of services or products offered, trouble fixing and charges given to spa customers. Most of the respondents agreed with the consequences of this observe via way of means of displaying a correlation coefficient of 0.789 because of this that a completely nice dating even as the p-price is 0.000 that is much less than the excessive widespread stage that is 0.01. This observe can show the reliability of spa patron emotional. Therefore, in an effort to offer pride to therapist customers, it's far essential to boom using fitness merchandise for spa customers.

### **Discussion on Hypothesis 2**

The second hypothesis is assurance, the therapist's knowledge, politeness, and ability to create confidence in spa customers. The results of the study show that the correlation coefficient is 0.793, indicating a very positive relationship, so the agreement between the respondents is high, with a p-value of 0.000, which is below the significance level of 0.01. Security is therefore very important to give spa customers trust and confidence.

### **Discussion on Hypothesis 3**

The third hypothesis is empathy. This is indicating a being concerned attitude, and the non-public interest given to spa customers. The essence of the empathy measurement is to expose the client via the carrier supplied that the client is special, and their wishes may be understood. As an end result of the

study, the respondents agreed via way of means of displaying a correlation coefficient of 0.803 at the same time as the p-cost is 0.000 that's much less than the 0.01 sizeable level. This indicates that empathy is carefully associated with client relations, is the capability to experience or revel in what some other individual is feeling or experiencing via way of means of imagining what it might be want to be in that individual's position. Therefore, empathy is carefully associated with emotional client spa.

#### **Discussion on Hypothesis 4**

A fourth hypothesis is responsiveness. This is the awareness and desire to support clients who come to the spa for beauty treatments. Most respondents supported the results of this study, with a correlation coefficient of 0.777 and a p-value of 0.000, below the significance value of 0.01. This emphasizes diligence and accuracy in dealing with customer requests, inquiries and complaints. Therefore, in order to increase client satisfaction, therapists should provide clear explanations and due consideration to clients who request spa treatments.

#### **Discussion on Hypothesis 5**

This discussion aims to assess the post-service experience on emotional effects on spa users in Kota Bharu, Kelantan. The results of the study show that there is a significant relationship between the independent variables namely reliability, assurance, empathy, responsiveness while the dependent variable is the emotional impact on spa users in Kota Bharu, Kelantan. Independent variables and dependent variables are very influential during the study. Then, to show stronger evidence during the study, the researcher found that person correlation showed positive.

This study builds a new avenue by highlighting the recommendations of proposals for potential research advances. Firstly, it is recommended that future researchers to change existing data collection methods to qualitative methods. Qualitative research generates data in a different way that quantitative research seems not to. Interviews, observations, and document analysis are examples of qualitative data. The key supporters in validating the fieldwork conducted in the qualitative study are field notes and researcher

diaries. Future researchers are recommended to use qualitative methods such as telephone surveys and face-to-face interviews in their study.

In addition, future researchers may be able to collect data by expanding the survey scope to all regions rather than focusing only on Kota Bharu, Kelantan. Because future research will be able to collect more comprehensive data in all areas to gather and efficiently confirm facts. The collected data will also allow us to more accurately determine how spa customers feel after their treatments.

Then future researchers will be able to update, improve and recreate the journal. In this study, researchers used standard journals to compare data from Western countries. As a result, cultural differences between Western and Eastern students may reflect different perspectives and make different recommendations, resulting in a based situation.

## **CONCLUSION**

In conclusion, the study's objectives are to analyse the role of reliability to the emotional impact of spa customers, analyse the role of assurance in influencing the emotions of spa customers, measure the role of empathy aspect spa customers, and measure responsiveness towards spa emotion in Kota Bharu, Kelantan. The hypothesis of this study was developed using Pearson Correlation Coefficient and descriptive analysis. The study's findings were provided in the previous chapter. The findings, limitations, and suggestions of this study will be discussed in this chapter. From the results obtained, it is found that there is a significant relationship between the four independent variables, which are reliability, assurance, empathy, and responsiveness, assessing the post-service experience of the spa on emotions among spa customers in Kota Bharu, Kelantan.

## REFERENCES:

- A. Rothstein. (2020). The Role of Communication in Massage Therapy. *Journal of Minnesota School of Cosmetology*, 17.
- Ada S. Lo & Corrine Wu (2014) Effect of Consumption Emotion on Hotel and
- Ahrholdt, D. C., Gudergan, S. P., & Ringle, C. M. (2017). Enhancing service loyalty: The roles of delight, satisfaction, and service quality. *Journal of Travel*
- Ahtola, O. T. (1985). Hedonic and utilitarian aspects of consumer behaviour Alalak, B. A., & EL-refae, G. A. (2012). The Relationships between Service Quality, Satisfaction, and Behavioural Intentions of Malaysian Spa Centre Customers. *International Journal of Business and Social Science*, 3(1), 198.
- Akter, M., Sadekin, M. N., & Patwary, A. K. (2020). An Empirical Study on Students' Satisfaction from Mawlana Bhashani Science & Technology University, Bangladesh. *Review of Economics and Development Studies*, 6(2), 363-379.
- Al-alak, B. A., & EL-refae, G. A. (2012). The Relationships between Service Quality, Satisfaction, and Behavioural Intentions of Malaysian Spa Centre
- Ali, F., Amin, M., & Cobanoglu, C. (2016). An Integrated Model of Service Experience, Emotions, Satisfaction, and Price Acceptance: An Empirical Analysis in the Chinese Hospitality Industry. *Journal of Hospitality Marketing & Management*, 25(4), 449-475.
- Alom, S., Patwary, A. K., & Khan, M. M. H. (2019). Factors affecting the turnover intention of Bangladeshi migrants in the United Arab Emirates: An empirical study on the hotel industry. *International Journal of Innovation, Creativity and Change*, 8(3), 344-360.
- Anderson, E.W., Fornell, C., and Lehmann, D.R., (1994), Customer Satisfaction, Market Share, and Profitability; Findings from Sweden, *Journal of Marketing*, Vol. 58, pp. 53-66.
- Loyalty\_Link\_An\_Empirical\_investigation\_of\_Spa\_and\_Beauty\_industry
- Aswin Sangpikul, (2021). Service Quality through Spa Customers' E-complaints in Bangkok, 569-596. <https://www.tandfonline.com/doi/abs/10.1080/1528008X.2021.1891598>
- Awoke, H., & Wollo, S. (2015). Service quality and customer satisfaction: empirical evidence from saving account customers of banking industry. *European Journal of Business and Management*, 7(1), 144-165. <https://www.abacademies.org/articles/An-assessment-of-service-quality-by-thaisappaya-spa-customers-an-empirical-analysis-1939-6104-20-3-752.pdf>

- Cacioppo, J. T., & Petty, R. E. (1982). The need for cognition. *Journal of Personality and Social Psychology*, 42, 116–131.
- Chang Huh, (2019, February). A Profile of Spa-goers in the U.S Luxury Hotels and Resorts: A Posteriori Market Segmentation Approach. *Journal of Hospitality Marketing & Management* 28(1): 1-21.
- Choi M, Poade D, Sohn M, Choi M. Spa Goers' Repeated Visits for Health and Wellness and the Influential Factors: An Exploratory Study of the UK Spa Goers. *Health Care (Frederick)*. 2016 Jul-Sep;35(3):241-50. doi: 10.1097/HCM.000000000000121. PMID: 27455366. <https://pubmed.ncbi.nlm.nih.gov/27455366/>
- Customers. *International Journal of Business and Social Science*, 3(1), 198-205.
- Dan Fleetwood, (2019). *Journal of Types of Sampling Methods*, 23(9) [blog/types-of-sampling-for-social-research/](http://blog/types-of-sampling-for-social-research/)
- Dana P. Turner. (2020). *Sampling Methods in Research Design*. *Journal of*
- Department of Statistic Malaysia Official Portal. (2023) *Journal of The Sources of Malaysia's Official Statistics*. 1 (22).
- Fengmin, Z., Baijun, W., Jiangtao, B., Li, L., & Patwary, A. K. (2022). Investigating revisit intention of medical tourists in China through nutritional knowledge, perceived medical quality, and trust in the physiologist: A recommendation on health tourism policy measures. *Frontiers in Public Health*, 10, 893497.
- Hazbar, A. M. H., Alem Mohammed, A., & Karim, A. K. A. (2019). An Empirical Study of Factors Influencing hotel customers' online booking Intention. *مجلة العلوم التربوية و الدراسات الإنسانية*, (5), 1-17. DOI: 10.1080/10548408.2014.895692 (<https://doi.org/10.1080/10548408.2014.895692>)
- Hyeyoon Choi, (Dec, 2016) The Implication of Services Cape, Emotion and Trust to a Positive Customer Service Experience: Wellness Spa Context in the U.S.A. *Journal of Service Management and Sustainability* 1 (12).
- Instrument for Motivation Factors towards Visiting Spa and Wellness Tourism. 185-189. [https://www.researchgate.net/publication/339353032\\_Validating\\_the\\_Measuring\\_Instrument\\_for\\_Motivation\\_Factors\\_towards\\_Visiting\\_Spa\\_and\\_Wellness\\_Tourism\\_Destinations\\_in\\_Kuala\\_Lumpur](https://www.researchgate.net/publication/339353032_Validating_the_Measuring_Instrument_for_Motivation_Factors_towards_Visiting_Spa_and_Wellness_Tourism_Destinations_in_Kuala_Lumpur)

- Laxmi Khadka, (May, 2015) *Journal of The Significance of Employee Wellbeing while Delivering Wellness and Spa Services*, 4 (65).  
[http://dspace.ut.ee/bitstream/handle/10062/49491/khadka\\_laxmi.pdf](http://dspace.ut.ee/bitstream/handle/10062/49491/khadka_laxmi.pdf)
- Li, L., Ragavan, N. A., Patwary, A. K., & Baijun, W. (2022). Measuring patients' satisfaction toward health tourism in Malaysia through hospital environment, nutritional advice, and perceived value: A study on Chinese exchange students. *Frontiers in public health*, 10, 893439.
- Li, L., Wu, B., & Patwary, A. K. (2022). How marine tourism promote financial development in sustainable economy: new evidences from South Asia and implications to future tourism students. *Environmental Science and Pollution Research*, 29, 1155-1172.
- Li, L., Wu, B., & Patwary, A. K. (2022). The psychosocial factors affecting chinese Outbound Exchange and mobility students' academic performance during COVID-19. *Frontiers in psychology*, 13, 872516.
- Lo, A., Qu, H., & Wetprasisit, P. (2013). Chinese tourists' perception of spa visitation as a tourism experience. *Journal of China Tourism Research*, 9(4), 429–451.
- Lo, A., Wu, C., & Tsai, H. (2015). The impact of service quality on positive consumption emotions in resort and hotel Spa experiences. *Journal of Hospitality Marketing and Management*, 24(2), 155-179.
- Mazhari, M., Madahi, A., & Sukati, I. (2012). The effect of relationship marketing on costumers' loyalty in Iran Sanandaj City Banks. *International Journal of Biometrics*. /10.5539/IJBM.V7N15P81.
- Min Hou, Xiaoding Wu and Zuohao Hu. "Personnel Service, Consumption Emotion, and Patronage Intention in Department Stores. *Journal of " International Business Research*, (2013). 10.5539/IBR.V6N3P6.
- Pai, F. Y., Chen, C. P., Yeh, T. M., & Metghalchi, M. (2017). The effects of promotion activities on consumers' purchase intention in chain convenience stores. *International Journal of Business Excellence*, 12(4), 413-432. <https://doi.org/10.1504/IJBEX.2017.085005>
- Patwary, A. K., Roy, B., Hoque, R., & Khandakar, M. S. A. (2019). Process of developing a community based tourism and identifying its economic and social impacts: An Empirical study on Cox's Bazar, Bangladesh. *Pakistan Journal of Humanities and Social Sciences*, 7(1), 1-13.
- Petty, R. E., Briñol, P., Loersch, C., & McCaslin, M. J. (2009). Journal of The need for cognition. In M. R. Leary & R. H. Hoyle (Eds.), *Handbook of individual differences in social behaviour* (pp. 318–329). New York, NY: Guilford Press.
- Resort Spa Experience, *Journal of Travel & Tourism Marketing*, 31:8, 958-984,

- Spyridoula Vryoni, (2017, June). Customers Satisfaction and Services Quality of Spa Centres in Greece. *Journal of Aristotle University of Thessaloniki*. (12- 18).
- Sumethokula, P., Patwary, A. K., Srinuanpanc, B., Srinuanpand, C., Suwandee, P., Thammathikul, A., & Phanong, W. (2020). The potential of new tour repackaging for creative tourism among entrepreneurs in Nakhon Si Thammarat. *International Journal of Innovation, Creativity and Change*, 13(10), 1752-1771.
- The roles of delight, satisfaction, and service quality. *Journal of Travel Research*, 56(4), 436-450.
- Tiga, B., Kajian, M., & Pengenalan, I. (n.d.). (1991). *Metodologi Kajian*. (103). [http://studentsrepo.um.edu.my/5187/4/bab\\_3.pdf](http://studentsrepo.um.edu.my/5187/4/bab_3.pdf)
- Vryoni, S., Bakirtzoglou, P., & Ioannou, P. (2017). Customers' satisfaction and service quality of spa centres in Greece. *Acta Kinesiologica*, 11(1), 12-18. <https://actakinesiologica.com/wp-content/uploads/2017/11/04CL-02-SV.pdf>
- Wu, B., Liu, S., Wang, J., Tahir, S., & Patwary, A. K. (2021). Assessing the mechanism of energy efficiency and energy poverty alleviation based on environmental regulation policy measures. *Environmental Science and Pollution Research*, 28, 40858-40870.
- Wu, B., Zhai, B., Mu, H., Peng, X., Wang, C., & Patwary, A. K. (2021). Evaluating an economic application of renewable generated hydrogen: A way forward for green economic performance and policy measures. *Environmental Science and Pollution Research*, 1-15.
- Zhong, Y., Xu, T., Dong, R., Lyu, J., Liu, B., & Chen, X. (2017). The analysis of reliability and validity of the IT-MAIS, MAIS and MUSS. *International journal of paediatric otorhinolaryngology*. 10.1016/j.ijporl.2017.03.006



# EXPLORING SUCCESS FACTORS INFLUENCING THE EFFECTIVENESS OF WELLNESS INITIATIVES ACTIVITIES IN THE UNIVERSITY

*Nur Ain Anisya binti Mohd Nor Aripin, Nur Ain Fazarina binti Ibrahim, Nurin Eliana Jasmeen binti Mohd Johari & NurFatin Athirah binti Ibrahim, & Ahmad Faezi bin Ab. Rashid*

*Faculty of Hospitality, Tourism and Wellness, University Malaysia Kelantan*

*Corresponding email: [faezi.ar@umk.edu.my](mailto:faezi.ar@umk.edu.my)*

---

## ABSTRACT

A wellness initiative can be defined as an activity that aims to improve and promote health and fitness that is usually offered in universities or working place. The wellness initiative activities carried out in the university can provide mental and physical relief to students. **Issue:** At the University Malaysia Kelantan (UMK) City Campus, there was a lack of facilities and equipment, students did not have a proper track to do exercise like running or jogging. Student may experience physical and mental issue of as result of their lack of motivation to engage in structured and regular sporting activities. **Method:** Cross-sectional study design was applied in the present study. The data were collected among 361 students of the University Malaysia Kelantan (UMK) City Campus. Descriptive analysis and Pearson correlation coefficient were used to analyse the data using SPSS version 26.0. **Result:** The Pearson correlation values for the facilities, leadership support, student awareness, and participant involvement towards the effectiveness level of the wellness initiatives ranged from 0.70 to 0.91. The data also revealed that the factors were significantly correlated with the effectiveness of wellness initiative activities in the university. **Conclusion:** Effective wellness initiative activities could reduce the prevalence of unhealthy lifestyles among students. The involvement of university students in wellness initiative activities may also improve their mental health, well-being, and academic achievements.

**Keywords:** Facilities, Leadership support, Student awareness, Participant involvement, The effectiveness level of the wellness initiatives

---

## INTRODUCTION

The level of the wellness is the degree to which a person realizes and chooses to engage in healthy behaviours daily. Well-being occurs when a person is free from any disease. It is a dynamic growth. A healthy body does not mean that a person has reached a level of well-being, but it needs to include both physical and mental aspects, i.e., internal and external health. Health is “a state of complete physical, mental, and social well-being and not merely the absence of disease or infirmity” (World Health Organization, 2020).

Well-being affects student performance in learning. Previous research showed that student well-being has a significant impact on student performance. Student achievement results affect high cognitive well-being. (Govorova, Benitez & Muniz, 2020). Among the importance of well-being among students is being energized. Energize is not only obtained through nutrition but also sleep. Sleep is also psychological well-being. Students must attend classes, complete assignments, study, maintain a social life, and there are even students who work part-time to cover living expenses. As a single integrated setting that includes academic, professional, and social activities, as well as health care and other support services, universities and colleges have the potential to improve the mental health and well-being of young

adults significantly. While universities continue to grow, there is growing worried that the resources provided to help students and staff are not progressing at the same rate. More concern should be highlighted for those with mental health issues and poor levels of well-being. This study aims to examine the factors that influence mental health and well-being among student the University of Malaysia Kelantan.

In addition, a healthy mind is essential to a healthy community. One of the most pressing issues in health care in the twenty-first century is the lack of effective mental illness promotion, prevention, and treatment programmes. According to the World Health Organization (WHO), a healthy mind is a “state of well-being in which every individual realizes their own potential, can cope with the normal stresses of life, can work productively and fruitfully, and is able to contribute their community”. (Velten, Bieda et al. 2018). Student lifestyle also affect mental health; students don’t get enough nutrition from food, which is caused by insufficient financial resources. Students have no other option but to choose unhealthy foods such as instant noodles. Not only that, but irregular sleep also affects student health and well-being and makes students unable to focus on class. Students also need to face the screen for a long period of time to join the class, complete assignments, and take assessments.

The study consists of four objectives:

1. To identify the relationship between leadership support and the effectiveness level of wellness initiative activities at the University Malaysia Kelantan.
2. To identify the relationship between student awareness and the effectiveness level of wellness initiative activities at the University Malaysia Kelantan.
3. To identify the relationship between participant involvement and the effectiveness level of wellness initiative activities at the University Malaysia Kelantan.
4. To identify the relationship between facilities and the effectiveness level of wellness initiative activities at the University Malaysia Kelantan.

## **Significance of the Study**

### ***Body of Knowledge***

This study can help increase knowledge on the importance of wellness initiatives as researchers want to embed the mind of prioritizing wellness among students. It is also a medium to inform the importance of this study to the university management so that they can take appropriate action to provide and improve the facilities.

### ***Practicality***

Practicality can help to improve the capacity of wellness initiatives on campus. This study can prove that the wellness initiative is not only about physical exercise, but it is also about the mentality to practicing a healthy lifestyle. For example, the students are able to manage their stress as they know what they have to do. like take a nap or mingle with their friends. Thus, wellness is such a broad concept. It also convinces the student representative council to raise the issue about the insufficient facilities and lack of awareness among students and the top management. University Malaysia Kelantan has a lot of students, so it is worth providing sufficient recreation facilities.

### ***Community***

This study focuses on higher education settings, but at the same time, it can replicate the study in a broader setting which means it is not limited to campus but to the community. Facilities play a significant role in improving motivation towards a healthy lifestyle. For example, housewives may want to join and support

the wellness program, but there is no incentive for them to do so. Most of them cannot participate in wellness initiative activities because they do not want to leave their children alone at home. Thus, this study will replicate on how these factors will contribute to wellness initiatives in terms of residential park aspects.

### ***Policy Maker***

This study is to let the top management know the importance of wellness initiatives and convince them to take possible action to improve the wellness initiatives in the university.

## **LITERATURE REVIEW**

Wellness encourages a person to achieve balance in life to ensure that the body remains healthy. Wellness has seven dimensions (physical, mental, financial, spiritual, environmental, vocational, and social). These seven dimensions are interrelated with each other. Without one of these dimensions, it may affect the other dimensions. This section will include a critical analysis of the sources. In the research literature, this study shows the understanding of the success factors of the effectiveness of well-being initiatives among students at the University Malaysia Kelantan. Previous studies showed that the success factors, such as facilities, leadership support, student awareness, and participant involvement. Success factors or important success factors are crucial actions needed to guarantee the achievement of an organisation. Previous studies showed that the success factors, such as facilities, leadership support, student awareness, and participant involvement, contributed to the effectiveness level of the wellness initiatives activities. The awareness of the well-being facilities offered by the university is an internal aspect that contributes to the success of the campus well-being initiative among the students of the University Malaysia Kelantan (UMK) City Campus. Students worked together to achieve this effectiveness by utilising the available resources. The effectiveness of campus well-being among the students of City Campus is greatly influenced by external success factors, which are elements that originate from outside the individual. According to Brown's definition from 2007, external influences vary depending on the person, but in general, they are exclusively based on situations outside of the student's control and influence.

### **Facilities**

The purpose of a spa at University Malaysia Kelantan is to give a space where the students can go to relax their body and their mind. By incorporating unique themes (e.g., gym, spa, netball, and futsal court) into spa facilities, it has attracted students to make use of the suggested wellness initiative (Sarah, E. Colby, 2010). The spa treatment offers the physical, emotional, and spiritual mending necessary for conserving a healthy way of life and extending life. Spa treatments can also increase the body's immunological response, decrease bodily inflammation, and ameliorate circulation. Also, going to a spa to relax and be cockered can ameliorate their self-esteem and internal clarity. Spa treatments, like massages, are non-medical procedures that help the body's wellness. According to scientific exploration, a frequent hand massage may soothe pain, improve hand strength, and lessen pressure and anxiety. Treatments for illnesses including neuropathy, carpal tunnel syndrome, and arthritis can all profit from hand massage.

### **Leadership Support**

To ensure that every activity can be arranged successfully, the support of leadership plays an important role. Administrative leaders in academia have permanent or fixed-term roles managing academic organisations or parts of them. Leaders in this category include the vice president, deans, and the Student Representative Council (SRC). Individuals in these positions are in charge of university leadership. These individuals serve multiple tasks simultaneously, such as departmental figureheads, staff, and student leaders. (Braun et al., 2016). Not only does financial support for the well-being programme matter, but it is also necessary to provide adequate facilities at the City Campus with enough financial support. Supporting students to manage stress and adversity could benefit their current and future health and well-

being student-learning. Universities that want to foster student resilience must look at the big picture rather than the details. (Holdsworth et al., 2018)

### **Student Awareness**

The term “awareness” is used interchangeably with the term “consciousness” and which shows a person's level of awareness of something. (John et al., 2000). The American Psychological Association defines awareness as the present-moment, judgment-free awareness of one's events. In other words, consciousness is a state and not a trait. Although often, particular techniques or activities are used to gain this awareness. Being conscious of one's own wellness is crucial, especially for students who are already aware of how depression, stress, and other conditions are frequently linked to it. In a 2013 survey by the National College Health Assessment, participants were asked to list the elements that influence their academic performance over the course of one semester. Student awareness can be improved with welfare exhibitions. Wellness programs may help students become aware of imbalances (Cohen, 2003, p. 204). This welfare exhibition can help students learn more about the significance of well-being while also raising their awareness of the topic.

### **Participant Involvement**

Participant involvement essential in ensuring that every university activity receives support from students at University Malaysia Kelantan (UMK). According to (Imms et al., (2017)), participation may include components of engagement, motivation, persistence, social connection, and affect level. Attendance is a necessary but not sufficient criterion for participation and involvement. If one participates in an activity on a regular basis, the likelihood of being involved in that activity increases. However, individuals may attend to various components of the same action, possibly because they are motivated by distinct goals; as a result, they may be participating in separate portions of the same activity. Planned activity is crucial since it can help students cope and manage stress while only addressing one aspect of student mental health; it is equally essential to create protective elements in the university's social and academic environment. In a university setting, this approach recognises the impact of the teaching and learning environment on students' mental health and wellness (Baik et al., 2019).

## Research Hypothesis

Four hypotheses have been tested in this study:

**H1:** There is a significant relationship between leadership support and the effectiveness level of wellness initiative activities at the University Malaysia Kelantan.

**H2:** There is a significant relationship between student awareness and the effectiveness level of wellness initiative activities at the University Malaysia Kelantan.

**H3:** There is a significant relationship between participant involvement and the effectiveness level of wellness initiative activities at the University Malaysia Kelantan.

**H4:** There is a significant relationship between facilities and the effectiveness level of wellness initiative activities at the University Malaysia Kelantan.

## Research Framework

Facilities, leadership support, student awareness, and participant involvement are the four independent variables (IV) listed in the conceptual framework, which is based on the researcher's research. The dependent variable is the efficacy level (DV). The goal of this study is to understand what makes campus wellness programmes successful in university. The following are some of the conceptual frameworks used in this study:

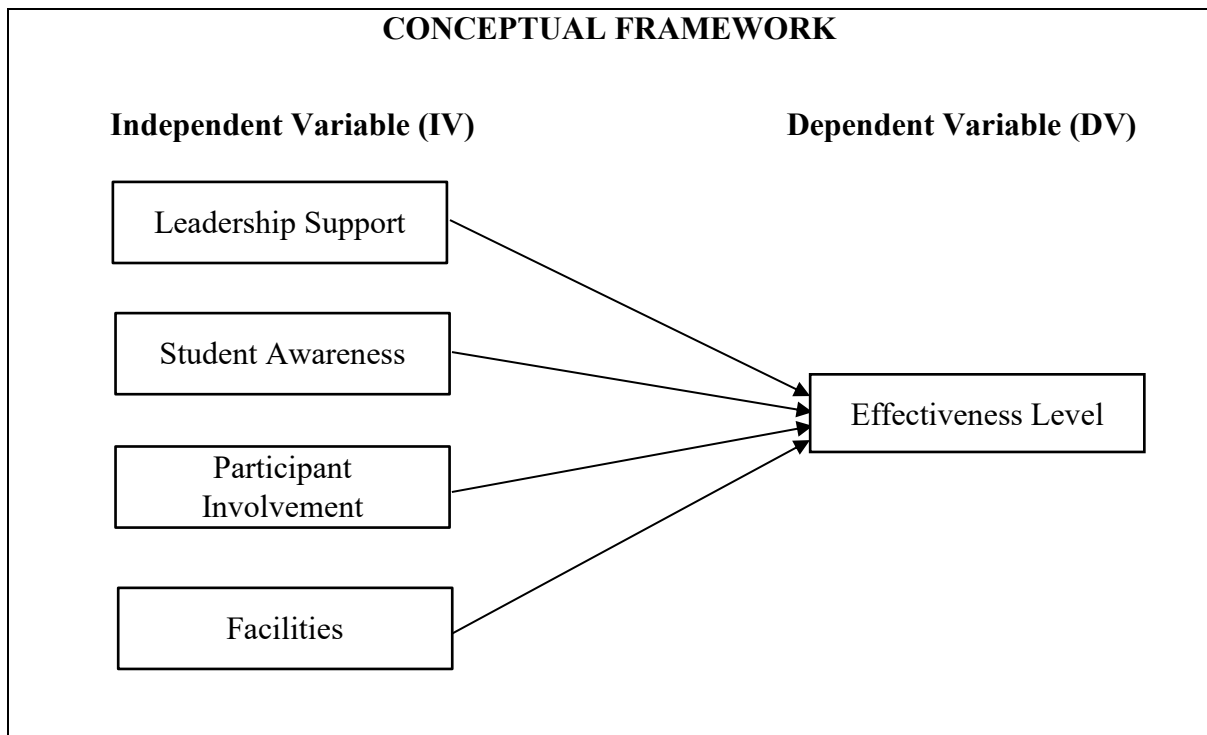

Figure 1: Research Framework

## **METHODOLOGY**

### **Research Design**

This study used a cross-sectional study. The method used by the researcher to collect data is by giving out questionnaires that are distributed to 361 respondents. The respondent was chosen by convenience sampling. Our target population for this study is from the University Malaysia Kelantan (UMK).

The questionnaire for this data collection process contains six sections which are section 1 related to the demographic (5 questions); section 2 about leadership support (6 questions); section 3 related to student awareness (5 questions); section 4 related to the participant involvement (7 questions); section 5 related to the facilities, (5 questions) and; section 6, about level of effectiveness, (7 questions). The Likert scale is the instrument that provides the most accurate measurement of respondents' most agreeable opinions. The Likert scales used in this study are: - 1 = Strongly Disagree, 2 = Disagree, 3 = Neutral, 4 = Agree, and 5 = Strongly Agree. The quantitative research approach, using a cross-sectional study design, was used to measure the relationship between the dependent variables, which are the level of effectiveness, and the independent variable, which are facilities, leadership support, student awareness, and participant involvement.

### **Data Collection**

A questionnaire has been distributed via Google Forms via WhatsApp. The students will have an explanation for a little information to avoid misunderstanding the questionnaire. They were given space and their own self-judgment of the success factors on the questionnaire. There are 361 respondents among 6814 students. The data were collected and analysed through a self-administrator questionnaire. The respondents must answer all the questions given.

### **Sampling**

Convenience sampling is a strategy used by this study to obtain research data from available groups of respondents. This method is used when there is a situation where the population is very large. It is also known as grab sampling or availability sampling. The data obtained from the respondents can help in solving specific issues. Students at University Malaysia Kelantan (UMK) were selected as target respondents. Convenience sampling will be used in this study because the total student population at University Malaysia Kelantan is large. The researcher utilised this sampling technique on 361 respondents because it was impossible to include all 6814 students in the study. Pilot studies frequently employ convenience sampling to gather information on success criteria for effectiveness in higher education settings. The poll was carried out independently. The approach was straightforward and suitable for the budget and schedule constraints.

### **Data Analysis**

An instrument used in analysing the data was statistical tool or Statistical Package Social Science (SPSS) version 26.0. Descriptive analysis was used to assess the data. One variable is considered at a time in a frequency distribution, which is a mathematical distribution. The frequencies were gathered, and a comparison using the supplied data was made. The information gathered revealed the influences of the success factor of the effectiveness of wellness initiatives among students at University Malaysia Kelantan. The study consists of descriptive analysis, reliability analysis, and Pearson Correlation.

## FINDINGS

### Demographic Profile of Respondents

Table 1 below shows the frequency analysis of this research.

Table 1: Result of Frequency Analysis

Characteristics	Frequency	Percentage (%)
<b>Age</b>		
18-20	60	16.6
21-23	281	77.8
24-26	6	1.7
27 and above	14	3.9
<b>Gander</b>		
Male	62	17.2
Female	299	82.8
<b>Race</b>		
Malay	261	72.3
Chinese	40	11.1
Indian	40	11.1
Other	20	5.5
<b>Marital Status</b>		
Married	13	3.6
Single	348	96.4
<b>Current Year of Study</b>		
Year 1	11	3.0
Year 2	61	16.9
Year 3	268	74.2
Year 4	3	0.8
Other	18	5.0

Table 1 illustrates the result of the frequency analysis of socio-demographic characteristics. The distribution based on age shows that 60 respondents (16.6%) were between 18-20 years old, 281 respondents (77.8%) were between 21-23 years old, 6 respondents (1.7%) were from 24-26 years old, and 14 respondents are among 27 years old and above. The majority the respondents were between the age of 21-23 years old. This is because most degree students range in age from 21 to 23 years old.

The total number of respondents for males was 62 respondents (17.2%), while the number of females was 299 respondents (82.8%). This study used the convenience sampling method, meaning that anyone who wants to answer the questions can survey. In this study, more female was interested answering the questionnaire. For the analysis of the respondents by race, 261 (72.2%) respondents were Malays, Chinese and Indian respondents both have the same total of respondents, which is 40 respondents (11.1%), and another 20 respondents (5.5%) were from other races. The highest number of respondents by race is Malay because the student community at University Malaysia Kelantan is mostly Malay.

Referring to marital status, 348 respondents were single (96.4%), and 13 of the respondents were married, which is 3.6%. The majority of the respondents were single because they were still studying for degrees. The analysis of current-year study respondents showed that there were 11 respondents (3.0%) in student year 1, 61 respondents (16.9%) in student year 2, 268 respondents (74.2%) in student year 3, 3 respondents (0.8%) in student year 4, and 18 students (5.0%) in other current year of study. The result showed that more third-year students answered the survey.

### Descriptive Analysis

Table 2 below shows the result of the descriptive analysis of this research.

Table 2: Result of Descriptive Analysis

Variables	Items	Mean	Standard
		Score (M)	Deviation (SD)
<b>Leadership support</b>	The faculty management and student representative council always participate in planning wellness initiative activities.	4.60	.716
	The faculty management and student representative council always take part in organizing wellness initiative activities.	4.62	.693
	The faculty management and student representative council make wellness initiative activities an important agenda in faculty or students' activities.	4.62	.705
	The faculty management and student representative council always encourage students to participate in wellness initiative activities.	4.61	.727



	The faculty management and student representative council have a clear objective for faculty or students' wellness initiative activities.	4.61	.698
	The faculty management and student representative council always promote the benefit of wellness initiative activities.	4.61	.714
<b>Student awareness</b>	As a student, I will always participate in planning the wellness initiative activities.	4.66	.583
	As a student, I will always participate in the wellness initiative activities organized by the university.	4.68	.575
	I am aware that participating in wellness initiative activities can improve my engagement with friends.	4.70	.498
	I am aware that participating in wellness initiative activities can reduce my stress levels.	4.68	.569
	I am aware that participating in wellness initiative activities can improve teamwork.	4.72	.485
<b>Participant involvement</b>	I will engage in wellness initiative activities if they are organized on weekends.	4.57	.742
	I will engage in wellness initiative activities if they are organized after lectures.	4.63	.645
	I will get involved in wellness initiative activities if they are run by external experts.	4.67	.556
	I will involve myself in the wellness initiative activities if managed by faculty management/student representatives.	4.67	.571
	I will engage in the wellness initiative activities if it is conducted online.	4.60	.692
	I will get involved in a wellness initiative activity if it is run in a fun way.	4.78	.445
	I will engage in wellness initiative activities if they are given incentives such as certificates, club memberships, and training hours.	4.77	.473

<b>Facilities</b>	The facilities for the wellness initiative activities provided by the university are good.	4.74	.470
	The wellness facilities become the main factors in organizing wellness initiative activities at the university/faculty level.	4.75	.515
	Good facilities can attract more participants to join the wellness initiatives activities at the faculty/university level.	4.78	.438
	Students should always be informed about the facilities provided at the university/faculty level to attract more participants to join the campus wellness initiative activities.	4.78	.450
	Wellness facilities were well maintained.	4.73	.550
<b>Level of Effectiveness</b>	Each wellness initiatives activities I participated in has fulfilled the desired outcomes.	4.68	.598
	Each wellness initiatives activities I participated in has a clear goal of healthy lifestyles.	4.71	.523
	All of the wellness initiatives activities are easy to participate in.	4.71	.554
	Students are informed about the wellness initiative activities carried out by the university/faculty.	4.72	.524
	I am highly satisfied with the wellness initiatives activities conducted at the university/faculty level.	4.71	.535
	The wellness initiatives activities schedule is flexible.	4.73	.537
	The wellness initiatives activities that I join have benefited me.	4.77	.451

Table 2 shows the results of means scores and standard deviation analysis on the independent variables, which are leadership support, student awareness, participant involvement, and facilities. The highest mean value for leadership support was for items 2 and 3. Item 2 receives a mean value of 4.62 (SD = .693): “The faculty management and student representative council always take part in organising wellness initiative activities”. Meanwhile, item 3 “The faculty management and student representative council make wellness initiative activities an important agenda in faculty, or students’ activities” receive a mean score of 4.62 (SD = .705).

Item 5 of student awareness has the highest mean value, which is 4.72 (SD = .485). The respondents strongly agree with the question, “I am aware that participating in wellness initiative activities can improve teamwork”. Item 6 for participant involvement has the highest mean value, which was 4.78 (SD = .445). Most respondents strongly agree with the question, “I will get involved in a wellness initiative activity if it is run in a fun way”.

Items 3 and 4 of the facilities have received the same mean value. In Item 3, which was 4.78 (SD = .438), the respondent strongly agreed with the question, “Good facilities can attract more participants to join the wellness initiatives activities at the faculty/university level”. In Item 4, whose mean value was 4.78 (SD = .450), respondents strongly agreed with the question, “Students should always be informed about the facilities provided at the university/faculty level to attract more participants to join the campus wellness initiative activities”. The lowest mean value was item 5, which was 4.73 (SD = .550). The respondent majority strongly agrees with the question, “Wellness facilities were well maintained”.

The highest mean value for the dependent variable; level of effectiveness item 7, was 4.77 (SD = .451). The respondent strongly agrees with the question, “The wellness initiatives activities that I join have benefited me”. Item 1 scored the lowest mean value, which was 4.68 (SD = .598), where the respondents strongly agreed with the question, “Each wellness initiatives activities I participated in has fulfilled the desired outcomes”.

### Reliability Analysis

Table 3 below shows the reliability analysis of this research.

Table 3: Result of Reliability Analysis

Variables	Number of Items	Cronbach's Alpha
Leadership Support	6	0.943
Student Awareness	5	0.851
Participant Involvement	7	0.857
Facilities	5	0.906
Level of Effectiveness	7	0.934

The result of the reliability analysis for Table 3 in this variable is that the number of items is as follows: leadership support (6), student awareness (5), participant involvement (7), facilities (5), and level of effectiveness (7). The reliability analysis was conducted in this analysis to determine Cronbach's Alpha values for all variables. The value of leadership support is Cronbach alpha 0.943; the value of student awareness is Cronbach alpha 0.851; the value of participant involvement is Cronbach alpha 0.857; the value of facilities is Cronbach alpha 0.906; and the level of effectiveness is 0.934. As a result of the pilot test, the overall result was acceptable and reliable for this study. According to the results, leadership support has the highest coefficient of 0.943, while student awareness has the lowest coefficient of 0.851.

## Pearson Correlation Analysis

Table 4 shows the result of the correlation analysis of this research.

Table 4: Result of Pearson Correlation Analysis

Hypothesis	R-value	P-value	Finding of Data Analysis
<b>H1:</b> There is a positive relationship between leadership support and the effectiveness level of wellness initiative activities in the university.	0.864	0.001	H1: Accepted
<b>H2:</b> There is a positive relationship between student awareness and the effectiveness level of wellness initiative activities in the university.	0.796	0.001	H2: Accepted
<b>H3:</b> There is a positive relationship between the participants involved and the effectiveness level of wellness initiative activities in the university.	0.797	0.001	H3: Accepted
<b>H4:</b> There is a positive relationship between facilities and the effectiveness level of wellness initiative activities in the university.	0.912	0.001	H4: Accepted

Hypothesis 1 (H1) proposed that leadership support is a positive relationship with the level of effectiveness. The finding reported in this study revealed that the reliability recorded value of Pearson Correlation, which is  $r = 0.864$ ,  $p = 0.000$ . Thus, the result accepts hypothesis 1 (H1), whereby leadership support is positively significant with the level of effectiveness.

Hypothesis 2 (H2) proposed that student awareness was a positive relationship level of effectiveness. The finding reported in this study revealed that the reliability recorded value of Pearson Correlation, which is  $r = 0.796$ ,  $p = 0.000$ . Thus, the result accepts hypothesis 1 (H1), whereby student awareness is positively significant with the level of effectiveness.

Hypothesis 3 (H3) proposed that the participant involved was a positive relationship with the level of effectiveness. The finding reported in this study revealed that the reliability recorded value of Pearson Correlation, which is  $r = 0.797$ ,  $p = 0.000$ . Thus, the result accepts hypothesis 3 (H3), whereby the participant involved is positively significant with the level of effectiveness.

Hypothesis 4 (H4) proposed that facilities were positive relationship with the level of effectiveness. The finding reported in this study revealed that the reliability recorded value of Pearson Correlation, which is  $r = 0.912$ ,  $p = 0.000$ . Thus, the result accepts hypothesis 4 (H4), whereby facilities were positively significant with the level of effectiveness.

## **DISCUSSION AND RECOMMENDATION**

For our first independent variable, leadership support, the study proved that there is a positive relationship between leadership support toward effectiveness level. According to (Holdsworth et al., (2018), ensuring that every activity can be arranged successfully, the support of leadership plays an important role. Supporting students to manage stress and adversity benefits their current and future health and well-being. The development of resilience, in particular, contributes to students' mental health and well-being and is supported by formal and informal practices both within and outside the classroom.

The second is student awareness. This study proved a positive relationship between student awareness toward effectiveness levels. According to (Daphne M. Davis et al., 2012) particular techniques or activities are used to gain this awareness. Being conscious of one's own wellness is crucial, especially for students who are already aware of how depression, stress, and other conditions are frequently linked to it. The university's failure to deal with the problem of lack of student awareness can affect the university's performance in the eyes of the world.

Next is the participants involvement. This study proved a positive relationship between participants involved toward effectiveness level. According to (Imms et al., 2017), participant involvement plays an important role in ensuring that every university activity receives support from students. Participation may include components of engagement, motivation, persistence, social connection, and affect level. Furthermore, this planned activity is crucial since it can help students cope and manage stress while only addressing one aspect of student mental health; it is equally important to create protective elements in the university's social and academic environment (Baik et al., 2019).

Our last independent variable is facilities. This study proved a positive relationship between facilities toward effectiveness levels. According to Glasgow, et al., (2021), welfare facilities are provided to ensure the well-being of students. The higher authorities of the university pay attention to the initiatives of facilities available to guarantee the well-being of students so that they are aware of the importance of taking care of health. The facilities provided are reserved for all users to ensure user activities run smoothly. With the availability of facilities, it will be able to benefit users if it is used well and prudently.

### **Recommendations for future research**

One area of further research could be to examine the impact of different types of wellness initiatives on student well-being. For example, a study could compare the effectiveness of mindfulness meditation programs versus exercise classes in reducing stress levels and improving mental health. This type of research could help universities determine which types of initiatives would be most effective for their student population. Another area that could be explored is the impact of peer-to-peer support on the success of campus wellness initiatives. Many universities have implemented programs where students can serve as peer mentors or wellness ambassadors to help their peers navigate available resources study could examine the impact of these programs on student engagement with wellness initiatives and their overall well-being.

Additionally, it would be helpful to investigate the role of technology in the success of campus wellness initiatives. Many universities have developed wellness apps or online resources for students to access information and resources related to their well-being. Research could examine the effectiveness of these resources in promoting healthy behaviours and improving student well-being. Furthermore, it is important to consider the role of diversity and inclusion in the success of campus wellness initiatives. A study could examine the effectiveness of wellness initiatives in promoting well-being for students from different backgrounds and identities. This could include exploring the impact of culturally responsive programming or examining the accessibility of wellness resources for students with disabilities.

## CONCLUSION

In conclusion, this study has been accomplished to discover the success factors and measure the level of effectiveness of the well-being initiative among the students of the University Malaysia Kelantan (UMK). Four independent variables, leadership support, student awareness, participant involvement, and facilities, have been chosen to examine their relationships with the dependent variable, effectiveness level. A total of 361 respondents from the University Malaysia Kelantan (UMK) were selected to examine the success factor and measure the level of effectiveness of the well-being initiative among the students. Overall, based on Pearson's correlation analysis, leadership support scored a value of \*0.864, followed by student awareness with \*0.796, participant involvement with \*0.797, and facilities with \*0.912.

## REFERENCES

- Abdollahi Far, H., Safania, A. M., Namazi Zadeh, M., & Azadfada, S. (2021). Identify the organizational factors involved in increasing students' participation in recreational sport activities at the university. *Research on Educational Sport*, 9(24), 187-212.
- Akter, M., Sadekin, M. N., & Patwary, A. K. (2020). An Empirical Study on Students' Satisfaction from Mawlana Bhashani Science & Technology University, Bangladesh. *Review of Economics and Development Studies*, 6(2), 363-379.
- Almutairi, K. M., Alonazi, W. B., Vinluan, J. M., Almigbal, T. H., Batais, M. A., Alodhayani, A. A., Alsadhan, N., Tumala, R. B., Moussa, M., & Aboshaiqah, A. E. (2018). Health promoting lifestyle of university students in Saudi Arabia: a cross-sectional assessment. *BMC Public Health*, 18(1), 1-10.
- Alom, S., Patwary, A. K., & Khan, M. M. H. (2019). Factors affecting the turnover intention of Bangladeshi migrants in the United Arab Emirates: An empirical study on the hotel industry. *International Journal of Innovation, Creativity and Change*, 8(3), 344-360.
- Ammendolia, C., Côté, P., Cancelliere, C., Cassidy, J. D., Hartvigsen, J., Boyle, E., Soklaridis, S., Stern, P., & Amick, B. (2016). Healthy and productive workers: using intervention mapping to design a workplace health promotion and wellness program to improve presenteeism. *BMC Public Health*, 16(1), 1-18.
- Baik, C., Larcombe, W., & Brooker, A. (2019). How universities can enhance student mental wellbeing: The student perspective. *Higher Education Research & Development*, 38(4), 674-687.
- Braun, S., Peus, C., Frey, D., & Knipfer, K. (2016). Leadership in academia: Individual and collective approaches to the quest for creativity and innovation. In *Leadership lessons from compelling contexts*. Emerald Group Publishing Limited.
- Fengmin, Z., Baijun, W., Jiangtao, B., Li, L., & Patwary, A. K. (2022). Investigating revisit intention of medical tourists in China through nutritional knowledge, perceived medical quality, and trust in the physiologist: A recommendation on health tourism policy measures. *Frontiers in Public Health*, 10, 893497.
- Fox, A. (2010). Printed questionnaires, research networks, and the discovery of the British Isles, 1650–1800. *The Historical Journal*, 53(3), 593-621.
- Hazbar, A. M. H., Alem Mohammed, A., & Karim, A. K. A. (2019). An Empirical Study of Factors Influencing hotel customers' online booking Intention. *مجلة العلوم التربوية و الدراسات الإنسانية*, (5), 1-17.

- Hernández-Torrano, D., Ibrayeva, L., Sparks, J., Lim, N., Clementi, A., Almukhambetova, A., Nurtayev, Y., & Muratkyzy, A. (2020). Mental health and well-being of university students: A bibliometric mapping of the literature. *Frontiers in Psychology, 11*, 1226.
- Holdsworth, S., Turner, M., & Scott-Young, C. M. (2018). Not drowning, waving. Resilience and university: a student perspective. *Studies in higher education, 43*(11), 1837-1853.
- Houghton, A.-M., & Anderson, J. (2017). Embedding mental wellbeing in the curriculum: maximising success in higher education. *Higher Education Academy, (forthcoming)*, 68.
- Krejcie, R. V., & Morgan, D. W. (1970). Determining sample size for research activities. *Educational and psychological measurement, 30*(3), 607-610.
- Li, L., Ragavan, N. A., Patwary, A. K., & Baijun, W. (2022). Measuring patients' satisfaction toward health tourism in Malaysia through hospital environment, nutritional advice, and perceived value: A study on Chinese exchange students. *Frontiers in public health, 10*, 893439.
- Li, L., Wu, B., & Patwary, A. K. (2022). How marine tourism promote financial development in sustainable economy: new evidences from South Asia and implications to future tourism students. *Environmental Science and Pollution Research, 29*, 1155-1172.
- Li, L., Wu, B., & Patwary, A. K. (2022). The psychosocial factors affecting chinese Outbound Exchange and mobility students' academic performance during COVID-19. *Frontiers in psychology, 13*, 872516.
- Mamurov, B., Mamanazarov, A., Abdullaev, K., Davronov, I., Davronov, N., & Kobiljonov, K. (2020). Acmeological Approach to the Formation of Healthy Lifestyle Among University Students. III International Scientific Congress Society of Ambient Intelligence 2020 (ISC-SAI 2020),
- Margaret, R. (2018). SPSS (statistical package for Social Science). In: What's. TechTarget. <https://whatis.techtarget.com/definition/SPSS> ....
- McCombes, S. (2022). Sampling methods| Types, techniques & examples. In: Scribbr. Retrieved from <https://www.scribbr.com/methodology/sampling-methods>.
- National Academies of Sciences, E., & Medicine. (2021). *Mental health, substance use, and wellbeing in higher education: Supporting the whole student*. National Academies Press.
- Patwary, A. K., Roy, B., Hoque, R., & Khandakar, M. S. A. (2019). Process of developing a community based tourism and identifying its economic and social impacts: An Empirical study on Cox's Bazar, Bangladesh. *Pakistan Journal of Humanities and Social Sciences, 7*(1), 1-13.
- Razinkina, E., Pankova, L., Trostinskaya, I., Pozdeeva, E., Evseeva, L., & Tanova, A. (2018). Student satisfaction as an element of education quality monitoring in innovative higher education institutions. *E3S Web of Conferences*,
- Ronccone, J. (2019). Healthy Campus Wellness Initiative: Bridging the Gap between Healthy Campus 2020. *AURCO Journal, 25*, 160-176.
- Siddiqui, S. (2015). Impact of self-efficacy on psychological well-being among undergraduate students. *The International Journal of Indian Psychology, 2*(3), 5-16.
- Sumethokula, P., Patwary, A. K., Srinuanpanc, B., Srinuanpand, C., Suwandee, P., Thammathikul, A., & Phanong, W. (2020). The potential of new tour repackaging for creative tourism among entrepreneurs in Nakhon Si Thammarat. *International Journal of Innovation, Creativity and Change, 13*(10), 1752-1771.
- Velten, J., Bieda, A., Scholten, S., Wannemüller, A., & Margraf, J. (2018). Lifestyle choices and mental health: a longitudinal survey with German and Chinese students. *BMC Public Health, 18*(1), 1-15.
- Wu, B., Liu, S., Wang, J., Tahir, S., & Patwary, A. K. (2021). Assessing the mechanism of energy efficiency and energy poverty alleviation based on environmental regulation policy measures. *Environmental Science and Pollution Research, 28*, 40858-40870.

Wu, B., Zhai, B., Mu, H., Peng, X., Wang, C., & Patwary, A. K. (2021). Evaluating an economic application of renewable generated hydrogen: A way forward for green economic performance and policy measures. *Environmental Science and Pollution Research*, 1-15.



# Customer Satisfaction With Traditional And Complementary Medicine (TCM) Services

Jayani A/P Murugayah, Ainul Syahirah Binti Yahaya, Nur Syazwanie Binti Mohd Zulkafli, Nurul Syuhadah Binti Mohd Shahrin &\*Dr. Aifa Rozaini Bt Mohd Radzol

*Faculty of Hospitality, Tourism and Wellness, Universiti Malaysia Kelantan*

*Corresponding email: aifa.r@umk.edu.my*

---

## ABSTRACT

The study is about the Traditional and Complementary Medicine (TCM) services that can help the public to understand about TCM therapies which are safe and effective. This study propose three independent variables namely Certified Therapist, Experienced Therapist, and Skillful Therapist towards Customer Satisfaction in Traditional and Complementary Medicine (TCM) Services. This study was conducted in TCM facilities Malaysia. The total sample size in this study was 385 respondents who participated through WhatsApp, Telegram, and others. The results shows that all the three hypotheses were supported. The researchers have also proposed a few recommendations related to the study.

**Keywords: Traditional and Complementary Medicine (TCM) services, Customer Satisfaction, Certified Therapist, Experienced Therapist, and Skillful Therapist.**

---

## INTRODUCTION

According to National Policy of Traditional & Complementary Medicine, Ministry of Health Malaysia (2007), TCM means a form of health-related practices designed to prevent, treat and manage illnesses or preserve mental and physical well-being of individuals, with alternatives and complementary therapies. It does not include medical or dental practices performed by registered medical or dental practitioners. Traditional and complementary medicine (TCM) is widely used particularly among patients with chronic diseases in primary care. Traditional medicine is important in providing healthcare to mankind and becoming more popular in the community, Traditional and Complementary Medicine Division. TCM is also an important component in our healthcare system which helps to improve the level of health and quality of life of Malaysians in relation to modern medicine. Next, the traditional and complementary medicine (TCM) Council was established in line with the enforcement of the TCM Act 2016 (Act 775) to regulate TCM practices and practitioners in Malaysia and to provide for matters connected with it.

There were three objectives of this research:

1. To investigate the relationship between Certified Therapist and Customer Satisfaction in Traditional and Complementary Medicine (TCM).
2. To investigate the relationship between Experienced Therapist and Customer Satisfaction in Traditional and Complementary Medicine (TCM).
3. To investigate the relationship between Skillful Therapist and Customer Satisfaction in Traditional and Complementary Medicine (TCM).

## **Significance Of The Study**

The outcomes of this study will help Traditional and Complementary Medicine (TCM) practitioners and employees in Malaysia. Investigating TCM customer satisfaction can be beneficial to the sector's administration as a whole. This study will assist them in identifying the most critical elements influencing customer satisfaction with TCM treatment. The research findings can potentially be utilized by the Malaysian government to improve oversight of the country's Traditional and Complementary Medicine (TCM) sector. As a result, Malaysia may have the world's most competent TCM practitioners. This study might also aid future research on the contentment of conventional and alternative medical practices.

## **LITERATURE REVIEW**

### **Certified Therapist**

"A clear and formal method of adding visible, salient, and trustworthy extrinsic information about a product or service" is what certification is defined as (Starr & Brodie, 2016). According to Hodgkins (1953), "certification is an official statement in writing by an official in the public or private service that confirms a candidate's compliance with established requirements." If a legislative act should mandate certification, this means that only certified personnel will be allowed to hold the position. Having this certification will ensure that the candidate who holds the certificate has met the prescribed conditions and has the necessary qualifications. For Traditional and Complementary Medicine (TCM) services, these services are the focus subject of this study's quality certification in the health sector, although it has been shown that other certifications serve multiple functions in other business contexts. Therefore, individuals who are involved with this TCM service must have a certified certification in the field of health or medicine.

### **Experienced Therapist**

The sum total of a worker's experiences with their employer is known as their therapist experienced (Pete, 2019). Specialists in the therapist experience have the power to alter workers' perceptions of therapist jobs and the company as a whole can be re-positioned into a more trustworthy culture if the personnel take the time to listen and respond appropriately. Employers save time and effort by not having to train new hires when employers bring in veterans in the field (Nelson, 2015). A trustworthy specialist can quickly become productive in their new position. Due to the gaps in knowledge the therapist fill in the leadership and communication skills that therapist contribute, the therapist are an invaluable member of the team. The organization could reap significant benefits from the decision to hire and train new personnels with no experience in the sector.

### **Skillful Therapist**

According to Knapp (1963), skillful can be defined as "the learned ability to bring about per-determined results with maximum certainty; often with the minimum outlay of time or energy or both." In a general perspective, skill refers to any ability acquired by training or practice, allowing individuals to perform well in multifarious types of tasks. Based on the Britannica Dictionary (2022), skillful is about having the training, knowledge and experience that is needed to do something well which means it is having a lot of skill. According to the Traditional and Complementary Medicine Council, Ministry of Health Malaysia (2021), practitioners of TCM should always act professionally and honestly while doing their obligations to protect their good reputation. So, TCM therapist should be competent and constantly strive to enhance their knowledge and skills. Skills of TCM therapist can be divided into two categories which are domain-general and domain-specific skills (IGI Global).

## Customer Satisfaction

Customer satisfaction is a person's emotion of joy or dissatisfaction after comparing the performance (results) of a product to the expected performance results (Kotler, 2019). If the performance falls short of expectations, the customer is unhappy; if the performance meets expectations, the customer is content; and if the performance exceeds expectations, the customer is highly satisfied or joyful (Kotler, 2019). Customer satisfaction is a mindset that is determined by the encounter. An evaluation of the features or benefits of a product or service, or the product itself, that brings a level of consumer enjoyment in relation to meeting consumer needs is called satisfaction. This satisfaction is derived from three factors: Certified Therapist, Experienced Therapist, and Skillful Therapist.

## Research Hypothesis

The hypotheses in the study are to find out whether there are any correlations or relations between dependent variables and independent variables:

H1: There is a positive relationship between Certified Therapist and customer satisfaction.

H2: There is a positive relationship between Experienced Therapist and customer satisfaction.

H3: There is a positive relationship between Skillful Therapist and customer satisfaction.

## Research Framework

Figure 1 below shows the research framework of this study.

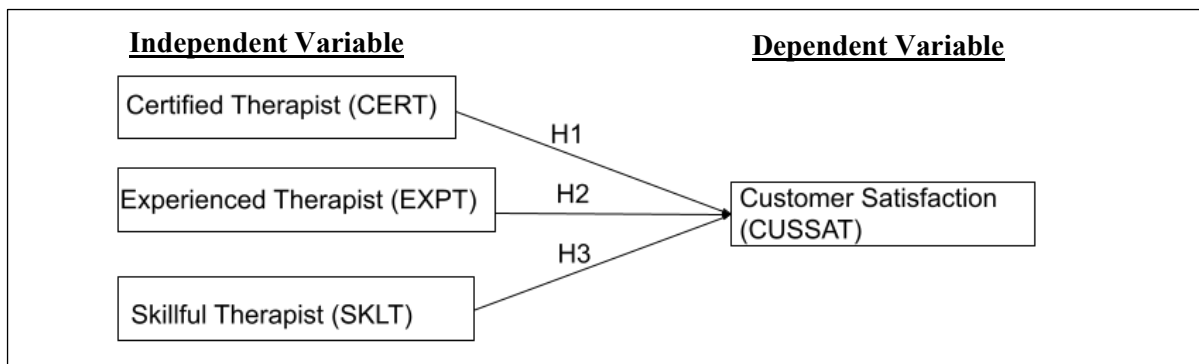

Figure 1: Research Framework

## METHODOLOGY

### Research Design

The framework of the study methods and procedures a researcher selects is known as the research design. The structure enables researchers to focus on research techniques that are appropriate for the field and set up their studies for success. The decision to be made regarding the research method is crucial to the study design process since it impacts how pertinent data may be gathered for a report. Several important factors must be considered when designing a study. According to Henry Manheim (1980), study design not only predicts and specifies the innumerable decisions associated with conducting data collection, processing, and analysis, but it also provides a logical justification for these choices.

There are two types of research design namely qualitative and quantitative. Qualitative research is gathering and evaluating non-numerical data, such as text, video, or audio, in order to better comprehend concepts, opinions, or experiences. Quantitative research produces factual, reliable outcome data that is

usually generalizable to some bigger populations, whereas qualitative research creates rich, detailed, and valid process data based on the viewpoints and interpretations of the participants rather than the investigators. Quantitative research is the systematic examination of phenomena through the collection of measurable data and the application of statistical, mathematical, or computational methodologies.

This study adopted a quantitative research design through the distribution of online surveys. Using a qualitative research design for this study because the researcher wants to receive a response as quickly as possible and from a specific group. This qualitative makes it easier for the researcher to carry out this study easily and accurately. For this study, an online survey is used so that it is easy to distribute and receive responses from customers who have received TCM therapy in a short time.

### **Data Collection**

Primary or secondary data sources may be used in data collection. Primary data is a type of information that is gathered by researchers directly from primary sources using methods including tests, questionnaires, and interviews. The best type of data for study is considered to be primary data, which is typically gathered from the original source.

Data that has previously been gathered from primary sources and made easily accessible for academics to use for their own research is known as secondary data. It is a category of information that has previously been gathered. The information may have been gathered by one researcher for a specific study and then made available for use by another researcher.

Data for this study is directly collected from customers who have received TCM therapy using primary data sources. These data are gathered using questionnaires that have been created with a number of TCM-related questions. A questionnaire is used to collect information on the relationship between a certified therapist, an experienced therapist, and a skillful therapist to the satisfaction of the customer. The questionnaire was distributed online, and data was collected from TCM service customers. This poll was performed online because it is simple to reach customers throughout Malaysia and since AI technology has advanced significantly in recent years. As a consequence, we know what they said.

### **Sampling**

Sampling is the process of choosing a portion of the population from which an assessment or inference about the complete population is made. By studying the sample and coming to understand its qualities or characteristics, the researcher can then generalize those properties or characteristics to the population's individual members (Ramayah, 2012). In general, the sampling method can be divided into two types, which are probability sampling and non-probability sampling.

Probability sampling means that every item in the population has an equal chance of being included in the sample. Creating a sampling frame first, then selecting samples from it using a computer program that generates random numbers is one method of conducting random sampling (Zikmund, 2002). Probability sampling techniques has five types of sampling, which are simple random sampling, stratified sampling, systematic sampling, cluster sampling, and multistage sampling.

Non-probability sampling technique is totally based on judgment (Sharma, 2017). There are four types of non-probability sampling techniques, which are convenience sampling, judgment sampling, quota sampling, and snowball sampling.

In this study, the researcher will use a non-probability sampling technique. Instead of that technique, convenience sampling will be used by the researcher because the researcher is aware that this sample is easier to get the respondents. Questionnaire forms will be distributed to respondents in Malaysia to ask

respondents to answer the questionnaire. The researcher will ask whether the respondents know or not about Traditional and Complementary Medicine (TCM) and their satisfaction with TCM.

### Data Analysis

According to Johnson (2022), data analysis can be defined as a process of cleaning, transforming, and modelling data to make a decision in business within the useful information. In order to make decisions based on data analysis, it is necessary to extract meaningful information from the data.

There are several types of data analysis that are available to use which consist of Diagnostic Analysis, Predictive Analysis, Prescriptive Analysis and Statistical Analysis, Kelley (2022). Descriptive analysis is either complete or selections of summarized numerical data, while Inferential analysis works with samples derived from complete data.

SPSS (Statistical Package for the Social Sciences) is a software program used by researchers to collect and analyze the data. The SPSS can help the researcher to extract the information from the file to do descriptive, inferential and other variant statistical procedures, William (2022). This study will use descriptive statistics, bivariate statistics and linear regression. This study will use SPSS version 16.0 using Pearson Correlation.

## FINDINGS

### Demographic Analysis

A total of 385 respondents participated in this study. Table 1 below shows the demographic analysis of this research.

Table 1: Demographic Analysis

<b>GENDER</b>	<b>Frequency</b>	<b>Percent</b>	<b>Valid Percent</b>	<b>Cumulative Percent</b>
Male	163	42.3	42.3	42.3
Female	222	57.7	57.7	100.0
<b>Total</b>	<b>385</b>	<b>100.0</b>	<b>100.0</b>	
<b>MARITAL STATUS</b>				
Single	205	53.2	53.2	53.2
Married	180	46.8	46.8	100.0
<b>Total</b>	<b>385</b>	<b>100.0</b>	<b>100.0</b>	
<b>AGE</b>				
18-27	188	48.8	48.8	48.8
28-37	66	17.1	17.1	66.0
38-47	75	19.5	19.5	85.5
48-57 Above	56	14.5	14.5	100.0
<b>Total</b>	<b>385</b>	<b>100.0</b>	<b>100.0</b>	

The gender distribution of a total of 385 respondents. Table 4.1.1, shows that male respondents were 42.3 percent (n=163) less than female respondents' which is 57.7 percent (n=222). The reason is female respondents are more than male respondents is because female prefer to go to receive TCM services to relax than males.

The marital status distribution of a total of 385 respondents. It clearly shows that Single respondents were 53.2 percent (n=205) more than Married respondent 46.8 percent (n=180). The reason Single respondents were more than married respondents is because had more time to go for TCM services but married respondent did not have time because they had to do housework.

Among these four age groups, the highest number of respondents were from 18 to 27 years, with 48.8 percent (n = 188). The second highest respondent age was from 38 to 47 years, 19.5 percent (n = 75) and followed by 17.1 percent (n = 66) respondents from the age 28 and 37 years. While the lowest number of respondents were from 48 to 57 years above with 14.5 percent (n = 56). The reason the age of respondents from 18 to 27 years has the highest number is that they want to calms their mind because of stress lifestyle. Meanwhile, Respondent 48 to 57 years above have the lowest number of respondents because they are preferring their own home remedies and they don't have much time for it.

## Descriptive Analysis

Table 2 below shows the descriptive analysis of this research

Table 2: Descriptive Analysis

Variable	Item	Mean score	Standard Deviation
Certified Therapist	Improve customer outcomes.	4.33	0.709
	The certified therapist provides better care.	4.36	0.727
	The certified therapist are improve customer care.	4.31	0.708
	The certified therapist are important to customers.	4.38	0.719
	The certified therapist benefits society.	4.34	0.741
Experienced Therapist	The experienced therapist create a satisfying and enjoyable environment.	4.36	0.758
	The experienced therapist are more likely to enable positive customer experience.	4.36	0.747
	The more experience the therapist the more the skill will be the develop.	4.34	0.734
	The performance and the productivity are influence by the therapist experience.	4.42	0.728
	The experienced therapist easily recognize the customer's problem.	4.32	0.790
Skillful Therapist	The therapist is skillful and have the professional attitude.	4.30	0.762
	The therapist is giving a clear explains during the treatment.	4.36	0.752
	The duration of treatment is appropriate for each treatment.	4.36	0.713
	The patience have an opportunity to express their opinion regarding the treatment section.	4.38	0.731

Customer Satisfaction	I'm satisfied with the therapy.	4.38	0.712
	I am delighted with the friendliness of the therapist.	4.40	0.711
	I am happy with cleanliness in the environment.	4.40	0.686
	Overall state the satisfaction of the service.	4.38	0.741

The frequency, mean and standard deviation for the items used to measure Certified Therapist. The higher questions measured for C4 (The certified therapist are important to customers.) Mean is 4.38. The questions, which were C3 (The certified therapist are improve customer care.) The mean is 4.31. The mean values C1, C2 and C5 are 4.36, 4.34 and 4.33.

The frequency, mean and standard deviation for the items used to measure the stage Experienced Therapist. There were five questions measured with one question having the highest mean E4 (The performance and the productivity are influence by the therapist experience.) 4.42 mean for the lower mean is E5 (The experienced therapist easily recognize the customer's problem.) with a 4.32 mean, continue with E1, E2 and E3 with 4.36 and 4.34 mean.

The frequency, mean and standard deviation for the items used to measure Skillful Therapist. There were one questions measured with the lowers means of 4.30 for question S1 (The therapist is skillful and have the professional attitude.). The higher measure is question S4 (The patience have an opportunity to express their opinion regarding the treatment section.) with 4.38 mean. Questions S2 and S3 with 4.36 mean.

The frequency, mean and standard deviation for the items used to measure the Customer Satisfaction. There were four questions measured with the two highest mean of 4.40 which is C1 and C4 (I'm satisfied with the therapy and Overall state the satisfaction of the service.) Meanwhile, the same means 4.38 for questions C2, and C3.

### Reliability Analysis

Table 3 below shows the results of the reliability analysis

Table 3: Reliability Analysis

Variable	Number of items	Cronbach Alpha
Certified therapist	5	0.930
Experienced therapist	5	0.903
Skillful therapist	4	0.891
Customer satisfaction	4	0.923

Table 3 presents the Cronbach's Alpha values of the questionnaire in between the range of very good level 0.930 to excellent level 0.891. A total number of three independence variables and one dependent variable has been tested using Cronbach's Alpha. The first independent variable, which is Certified Therapist found to be very good and reliable in the strength of Correlation (5 questions:  $\alpha = 0.930$ ). Then, the Experienced Therapist (5 question:  $\alpha = 0.903$ ) for Skillful Therapist was also found to be excellent in the strength of Correlation (4 question:  $\alpha = 0.891$ ). Lastly, Customer Satisfaction in TCM service is (4 question:  $\alpha =$

0.923). The overall variables have remained with 18 questions as the current Cronbach's Alpha result is already above the good level. Therefore, the data were considered suitable for further analysis.

**Table 4: Pearson Correlation Analysis**

Table 4 below shows the Pearson Correlation Analysis

Table 4: Pearson Correlation Analysis

Hypothesis	P.Value	Result (supported/ not supported)
There is a positive relationship between Certified Therapist and customer satisfaction.	0.823	H1 is supported
There is a positive relationship between Experienced Therapist and customer satisfaction.	0.850	H2 is supported
There is a positive relationship between Skillful Therapist and customer satisfaction.	0.856	H3 is supported

Based on the table 4, Pearson's Correlation Analysis was used to test the relationship between hypotheses on a significant relationship such as Certified Therapist, Experienced Therapist and Skillful Therapist in TCM service quality with Customer Satisfaction. Based on the result, all hypotheses were accepted at a 0.01 significant level.

**DISCUSSION AND RECOMMENDATION**

The purpose of the present study was to Customer Satisfaction with Traditional and Complementary Medicine (TCM) Service. Customer satisfaction has been measured in a variety of social sectors such as economy banks (Culiberg & Rojsek, 2010), the hotel industry Alexandris, Dimitriadis & Markata, 2002), restaurant business (Wall & Berry, 2007), health hospitals (Murti, Deshpande & Srivastava, 2013) and many more. This study focuses on three dimensions of variables which are Certified Therapist, Experienced Therapist, and Skillful Therapist. Certified Therapist refers to a professional who must be a licence psychologist with a doctorate from an approved university and have completed a license exam. Post-doctoral training under supervision is also essential, as are extra specialty-specific practise and tests. Providers must also be licensed by the state. In comparison, experienced therapist refers to a licensed psychologist, psychotherapist, counselor, or other qualified therapists with expertise in treating customers with mental health issues. Lastly is skillful, which refers to any skill that may be developed via practise or instruction that enables people to excel at a variety of activities. The last result of this study shows the relationship between hypotheses on a significant relationship such as Certified Therapist, Experienced Therapist, and Skillful Therapist in TCM services with customer satisfaction. All hypotheses were accepted at a 0.01 significance level. Several recommendations can be made to increase customer satisfaction, including willingness to help the customers, provide food and beverages to customers, and emphatic treatment of customers. The first recommendation is the willingness to help customers. It refers to the attitude of an employees who is willing to help a customer without being asked. This can be realized in each employee through training or company policy. So, the management of those TCM must create an environment of willingness to help the customers.

**CONCLUSION**



In conclusion, the study discovers Customer Satisfaction with Traditional and Complementary Medicine (TCM) Services. Three independent variables, Certified Therapists, Experienced Therapists, and Skillful Therapists have been chosen to examine the relationship with the dependent variable, Customer Satisfaction with Traditional and Complementary Medicine (TCM) Services. The data was taken from 385 respondents in the Google form. The respondents are from various age groups starting from 18 years old to 57 years old and above. Overall, based on Pearson's correlation analysis, the Certified Therapist scored a value of 0.930, followed by Experienced Therapists with 0.903, and Skillful Therapists with 0.891.

## REFERENCES

- Al Mahmud, S. R. (2020). The effectiveness of Facebook advertisements on purchase intention of customers in Malaysia. *South Asian Journal of Social Sciences and Humanities*, 1(1), 97-104.
- Chung et al. (2020, July 4). *Traditional and complementary medicine for promoting healthy ageing in WHO western Pacific region: Policy implications from utilization patterns and current evidence*. PubMed Central (PMC). <https://www.ncbi.nlm.nih.gov/pmc/articles/PMC7452244/>
- Ortiz, F. (2019, May 23). *Why having a skilled workforce is essential*. - Perth | Blue Collar People. <https://bluecollarpeople.com/access-skilled-workforce-essential/>
- Dottie. (2016, March 8). *Academic and training programmes for traditional and complementary medicine practices in Malaysia*. PORTAL MyHEALTH. <https://www.myhealth.gov.my/en/academic-and-training-programmes-for-traditional-and-complementary-medicine-practices-in-malaysia/>
- Ji Eun. (2022, January 25). *Twenty years of traditional and complementary medicine regulation and its impact in Malaysia: Achievements and policy lessons*. BioMed Central. <https://bmchealthservres.biomedcentral.com/articles/10.1186/s12913-022-07497-2>
- Kaur et al. (2018, December 19). *Patient satisfaction on the utilization of traditional and complementary medicine services at public hospitals in Malaysia*. <https://doi.org/10.1016/j.ctim.2018.12.013>
- Osikhotsali. (2010, September 28). *Understanding populations in statistics and everyday use*. Investopedia. <https://www.investopedia.com/terms/p/population.asp>
- Johnson. (2022, July 14). *What is data analysis? Research, types & example*. <https://www.guru99.com/what-is-data-analysis.html>
- Amadebai. (2021, March 28). *The importance of data analysis in research*. Analytics for Decisions. <https://www.analyticsfordecisions.com/importance-of-data-analysis-in-research/>
- William. (2022, September 23). *What is SPSS? Definition, features, types, and use cases*. SurveySparrow. <https://surveysparrow.com/blog/what-is-spss/>

- Yu Jin. (2017, October 22). *The current studies of education for a traditional and complementary medicine in Malaysia*. PubMed Central (PMC). <https://www.ncbi.nlm.nih.gov/pmc/articles/PMC5871307/>
- Personnel certificates*. (2023). Certipedia - Certificate Database from TÜV Rheinland. [https://www.certipedia.com/personal\\_certificates?locale=en](https://www.certipedia.com/personal_certificates?locale=en)
- LA. (2021, March 19). *How to get a certification in traditional Chinese medicine*. KPC. <https://kpc.com/articles/how-to-get-a-certification-in-traditional-chinese-medicine/>
- Johny. (2017, April 26). *Disclosure of traditional and complementary medicine use and its associated factors to medical doctor in primary care clinics in Kuching division, Sarawak, Malaysia*. Publishing Open Access research journals & papers | Hindawi. <https://www.hindawi.com/journals/ecam/2017/5146478/>
- Survey sampling methods & techniques* | Lucid. (2022, February 5). Cint™. <https://www.cint.com/blog/different-methods-of-survey-sampling>
- CK12-Foundation. (2023, January 7). CK-12 Foundation. <https://flexbooks.ck12.org/cbook/prep-for-8th-grade-math/section/3.9/related/lesson/sampling-methods-alg-i/>
- Mark, A. (2010, June 29). "The professional status of massage therapists: experience, employability, and evolution." *Journal of Human Resource Costing & Accounting*.
- M. Z. Y. Koh, Y.-N. G. (10 May 2021). "Willingness to pay for traditional, complementary and alternative medicine (TCAM) among Malaysian adults." *International Journal of Pharmaceutical and Healthcare Marketing*.
- Rajeev, M. (2019, August 21). *What is customer satisfaction?* Freshwork. <https://www.freshworks.com/freshcaller-cloud-pbx/call-center-software/customer-satisfaction-definition-blog/#:~:text=Philip%20Kotler%20defines%20customer%20satisfaction,is%20by%20no%20means%20ambiguous.>
- Yi, W. P. (2020). *PATIENT SATISFACTION TOWARDS TRADITIONAL AND COMPLEMENTARY MEDICINE SERVICES AT MINISTRY OF HEALTH FACILITIES, MALAYSIA*. Traditional and Complementary Medicine Division Ministry of Health Malaysia. [https://tcm.moh.gov.my/ms/upload/amalan/laporan\\_kajian/PSS2020.pdf](https://tcm.moh.gov.my/ms/upload/amalan/laporan_kajian/PSS2020.pdf)

# Adopting A Healthy Lifestyle: It's A Choice

**Muhammad Imran Bin Kadir, Nurul Syafiqah Binti Zambri, Nurul Adilla Binti Mohd Yunus,  
Nurul Husna Binti Abdul Halim & \*Aifa Rozaini Mohd Radzol.**

*Faculty of Hospitality, Tourism and Wellness, Universiti Malaysia Kelantan*

*Corresponding email: [aifa.r@umk.edu.my](mailto:aifa.r@umk.edu.my)*

---

## ABSTRACT

*A healthy lifestyle is one of the ways a person needs to live in order to achieve their optimal health including physical, mental, and social well-being. Researchers have shifted their focus to awareness of the importance of adopting a healthy lifestyle practice among communities. This is due to health issues that have arisen recently among communities that have become a public concern. The objective of this study is to investigate the relationship between peer influence, heredity disease and mental well-being in adopting a Healthy Lifestyle practice among communities in Malaysia. 384 respondents participated in this study which was conducted through Whatsapp, Facebook, and Instagram. This study focused on generation Z, a disease suffered and all Malaysians. The result showed that peer influence, heredity disease and mental well-being influence communities to adopt a healthy lifestyle.*

**Keywords: A Healthy Lifestyle, Peer Influence, Heredity Disease, Mental Well-being**

---

## INTRODUCTION

The World Health Organization (WHO), defines Health as a state of complete physical, mental, and social well-being, not simply just the absence of disease. While, the actual definition of Healthy Living is the steps, actions and strategies one puts in place to achieve optimum health. Healthy living is about taking responsibility for decisions and making smart health choices for today and for the future.

Healthy lifestyle practices are activities that are always done to maintain the health of the body. Dato' Seri Najib Tun Razak, who is the 6th Prime Minister of Malaysia once said that Malaysians should practice a healthy lifestyle to gain good from it. History proves that people in the past lived for a longer period than the people of today because they practiced a healthy lifestyle. Today's society suffers from many health problems because they do not practice a healthy lifestyle. The proof is that Malaysia has the highest number of diabetes sufferers in Asia, also among the most in the world after Saudi Arabia. According to the 2019 national health and morbidity survey (Nhms), the percentage of diabetic patients in Malaysia has risen from 13.4% in 2015 to 18.3% in 2019.

The level of health among Malaysians people is at a worrying level. Factors such as peer influence, heredity disease and mental well-being can affect healthy lifestyles, especially among students and other community members. The conditions such as heart disease, cancer, diabetes, joint disease, and mental illness are responsible for a vast number of deaths and disabilities. But, Many health problems can be prevented or at least their occurrence postponed by having a healthy lifestyle (Prsaanna, 2018). This is because a healthy lifestyle is one of which helps to keep and improve people's help and wellbeing (Prsaanna, 2018). A healthy lifestyle consists of eating a healthy diet, doing regular physical activity, avoiding toxic habits such as smoking (Grisolia, J.M, 2018). Thus, this study proposed three research objectives to explain the phenomenon.

1. To examine the relationship between peer influences and healthy lifestyle.
2. To examine the relationship between heredity disease and healthy lifestyle.
3. To examine the relationship between mental well-being and healthy lifestyle.

## **SIGNIFICANCE OF THE STUDY**

This study was significant for future researchers, disease sufferers, all Malaysians, and generation Z to improve well-being and prevent themselves from suffering from serious diseases. Furthermore, policymakers, health agencies, program planners, and community leaders can also use the data obtained from this study as a reference to plan and implement effective policies and programs for the Malaysian community to promote a healthy lifestyle.

## **LITERATURE REVIEW**

### **Peer Influence**

Peer influence meaning is when someone chooses to do something individuals like or not, because some individual wants to feel accepted and appreciated by a friend then individuals are willing to do it (Nadiah, 2021). Peer influence is the best way to describe how teenagers' behavior is shaped around their friends (Nadiah, 2021). Peer influence can be a positive and negative thing. For example, Peer influence can make a person interested in taking care of individual health with interesting activities such as group cycling on weekends, participating in exercise classes and more together (Aminuddin, 2014). Positive influence from friends can encourage them to be better and expose themselves to positive things. In addition, it can also be a negative thing when someone is led to try things that they are not usually interested in due to the influence of peers, such as smoking or social behavior (Nadiah, 2021).

Peer Influence is very important to create awareness of adopting a healthy lifestyle when an individual feels pressure from their peers. There will be a tendency for them to choose the same path as making a decision to follow in the footsteps of their friend, which is likely to be an action outside of the individual's character such as playing sports for awareness (Ann, 2021). It can also increase a person's productivity to practice a healthy lifestyle and can increase self-confidence (Aminuddin, 2014). On the other hand, peers are in a good position to promote the health of individuals if their own health is desired (Joseph L, 2021). It also allows a person to live a healthy life because of them who always guide that person to continue living a healthy lifestyle and shaping the direction of a person (Nadiah, 2021).

### **Heredity Disease**

Heredity disease is known as the process by which genes and characteristics are transmitted from parents to their children. Some of the genes from the mother combine with the father's genes to come up with a special combination of genes just for that child. Heredity disease can be categorized into three main groups which are single genes, chromosomal and also multifactorial diseases. Changes in the DNA sequence of single genes or known as mutations cause many diseases. Chromosomal occurs in every cell of the human body which has a full set of chromosomes but a child will inherit one set of chromosomes from each of its parents. Meanwhile, genetic disorders are the conditions that an infant is born with that can cause or be part of a set of conditions that can cause diseases (Professor B, 2021). In addition, multifactorial diseases are caused by a complex combination of genetic factors such as diabetes and heart disease (Dan Blazer, 2017).

Heredity disease plays a significant role in health, fitness and also wellness. Scientists have also discovered that people respond differently to exercise depending on their heredity disease condition. It is because people are starting to realize that making healthy lifestyle choices can help to counteract heredity diseases. As an example, adopting a healthy lifestyle can give people many benefits such as reducing their risk of diseases. Furthermore, heredity disease influences people to adopt a healthy lifestyle when one of biological parents died prematurely because of heredity disease such as cancer. So that, people can slow the process within the natural limits set by heredity disease by adopting healthy lifestyle habits such as following dietary patterns and engaging in physical activity (Béliveau, R., 2017). Heredity diseases are an important factor that lead people to practice a healthy lifestyle.

## **Mental Well-being**

The World Health Organization (1946) defines good mental well-being as “a state of well-being in which the individual realizes the abilities, can cope with the normal stresses of life, can work productively, and is able to make a contribution to community. Someone who does not have a stable mental health condition is more susceptible to diseases, makes rash decisions, and is easily influenced to engage in negative and self-destructive activities such as illegal racing, smoking drugs, and vandalism. Several examples that can be pointed out are the commonly encountered mental conditions such as depression, mental illness, and stress.

Western Australian Department of Health. (n.d) stated that ‘things that can lead to positive mental health include spending quality time with family members and close acquaintances, working in a job or finding an activity that is meaningful, finding fun activities, practicing relaxation techniques such as meditation, yoga or tai-chi and others’. This physical activity can improve mental health by helping the brain cope with stress and depression. Based, research shows that individuals who exercise regularly are twenty-five percent less likely to develop depression or mental disorders in the next five years (Isa, A. M. 2022).

## **Healthy Lifestyle**

In 1946, the World Health Organization defined a Healthy Lifestyle as the way a person lives in order to achieve optimal health with a state of complete physical, mental, and social well-being, which is not merely just the absence of disease only'. A healthy lifestyle is a life practice that positively impacts a person, family, and society. By adopting a healthy lifestyle as a way of life, individuals can improve their health, general mood, and extend their lifespan. Thus, people need to make healthy lifestyle changes starting with a step-by-step plan and then building a Healthy Lifestyle as habits.

In addition, there are some tips and ideas that people can use to achieve their wellness goals to make their life healthier. Among them is avoiding harmful activities, doing healthy things they enjoy, and taking care of their general well-being. If people keep in mind to remember these tips, people will be able to unlock a healthy and happy lifestyle. Also, people are advised to watch some videos that are being shared on the internet about healthy lifestyle tips as a reference to be able to follow the tips properly. Moreover, it is better to seek guidance from the experts such as therapists, coaches, or wellness entrepreneurs themselves to get more effective results.

## **Research Hypothesis**

This study investigates the relationship among these discussed variables. Based on the literature discussed, the hypotheses of this study were summarized in the following manner:

**H<sub>1</sub>:** There is a positive relationship between Peer Influence and adopting a Healthy Lifestyle.

**H<sub>2</sub>:** There is a positive relationship between heredity disease and adopting a Healthy Lifestyle.

**H<sub>3</sub>:** There is a positive relationship between mental well-being and adopting a Healthy Lifestyle.

## **Research Framework**

Figure 1 below shows the research framework used for this study.

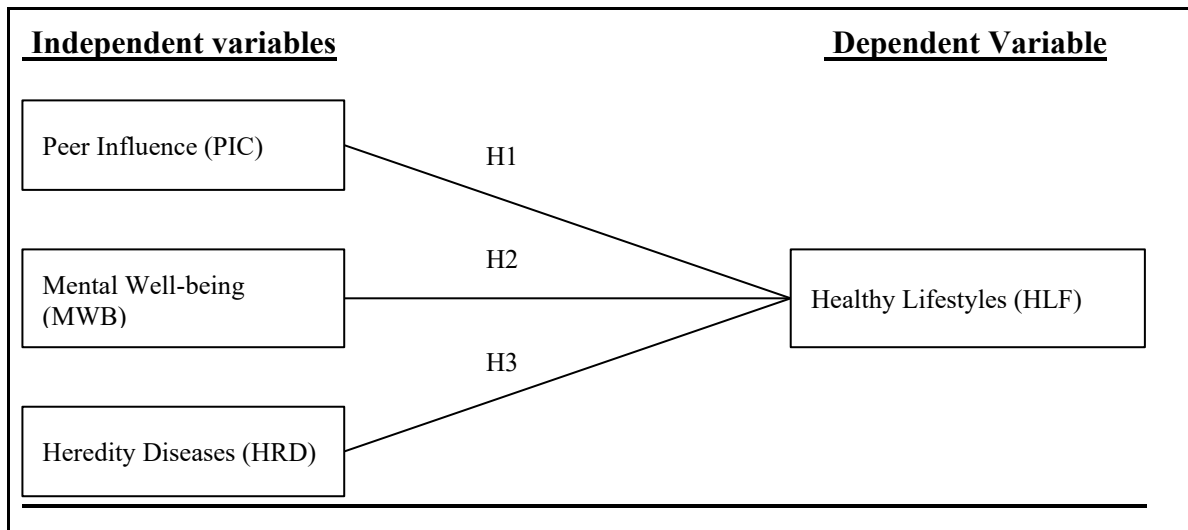

Figure 1: Research Framework

## METHODOLOGY

### Research Design

The researchers applied a quantitative research approach. The community in Malaysia was chosen as the representative group of people that gives opinions about Adopting a Healthy Lifestyle. The researcher chose community living in Malaysia because they are suitable respondents for a study about adopting a healthy lifestyle.

The questionnaire gathered all general information about adopting a healthy lifestyle. The five sections designed for the questionnaires in this research are section A, B, C, D and E. Section A, contains the respondent's demographic information. Section B till D was about the independent variables which are Peer Influences, Heredity Disease and Mental Well-being. Section E focuses on the dependent variable, which is Healthy Lifestyle.

### Data Collection

Data collection that the researcher used in this research is primary data. Data collection for this research was through an online questionnaire. The complete questionnaire was distributed via social media such as WhatsApp, Facebook and Instagram. The questionnaire was distributed in April 2023. Respondents who were suitable for the research criteria were randomly selected to answer the online questionnaires. It consists of the general public, contact with the family, and friends. This questionnaire was used to collect information regarding the awareness of the Importance of Healthy Lifestyle Practices among communities in Malaysia.

### Sampling

The sampling method that has been chosen is non-probability techniques by the researchers because the procedures used to select units for inclusion in a sample are much easier, and quicker. Convenience sampling is the easiest method because participants are selected based on availability and willingness to participate. In this study, certain characteristics that exist in the population or respondents are noticed by the researchers which cause purposive sampling to be used. Therefore, the data analysis techniques, such as frequency, descriptive, reliability, and correlation, are presented in the next section.

## Data Analysis

Data analysis is known as an evaluating method of assessing records with applying statistical, logical, and analytical. The tool that is used in this study to analyse the data collected is known as the statistical package for Social Science (SPSS). SPSS is a software that can explain the relationship between independent and dependent variables in terms of descriptive analysis and correlation. The software processes large datasets efficiently and helps researchers to perform complex statistical analysis. Therefore, the data analysis techniques, such as frequency, descriptive, reliability, and correlation, are presented in the section.

## FINDINGS

### Result of Demographic Analysis

Table 1 below shows the Demographic Analysis of this study

Table 1: Demographic Analysis

Characteristics	Frequency	Percentage
<b>Gender</b>		
Male	138	35.9
Female	246	64.1
<b>Age</b>		
18 – 25 years old	308	80.2
26 – 34 years old	47	12.2
35 – 42 years old	18	4.7
43 years old and above	11	2.9
<b>Marital Status</b>		
Single	330	85.9
Married	54	14.1

Table 1 above shows an analysis in Frequency and Percentage for each Socio-Demographic Characteristic based on data of descriptive analysis obtained from Part A in the questionnaire where demographic variables include gender, age, and marital status. This table 1 depicts the results of the socio-demographic characteristics of the 384 total respondents. Also, the respondents are people who adopt healthy lifestyle practices among communities in Malaysia.

First of all, it is the gender distribution where most respondents were female with 64.1 % (n = 246) while the rest were male with 35.9% (n = 138). Besides that, in terms of age distribution, the highest number of respondents were from 18 until 25 years old, with 80.2% (n = 308). The second highest number of respondents are from 26 until 34 years old, with 12.2% (n = 47). Next, followed up by another age group which is from 35 until 42 years old, with 4.7% (n = 14). Meanwhile, the last age group with the lowest number of respondents are from 43 years old and above, with 2.9% (n = 11). Moreover, the majority for Marital status of the respondents were Single, which consists of 85.9% (n = 330) of them. Which also means the Marital Status of remaining respondents who were married is equivalent with 14.1% (n = 14z).

## Result of Descriptive Analysis

Table 2 below shows the Descriptive Analysis of this study

Table 2: Descriptive Analysis

Variable	Items	Mean Score	Standard Deviation
Peer Influence	The influence of peers can affect my healthy lifestyle.	4.20	0.939
	The influence of peers can be an important factor in adopting a healthy lifestyle.	4.17	0.944
	The influence of peers is important in adopting a healthy lifestyle in my life.	4.17	0.887
	There are a few activities that related to peers' influence can affect my health.	4.18	0.896
Heredity Disease	A genetic is a disease.	3.88	1.124
	A genetic is a piece of DNA.	4.27	0.879
	I can see genetics with the naked eye.	3.42	1.419
	Some diseases are caused by genetics, environment and lifestyle.	4.27	0.789
	A genetic test can determine whether someone has a higher chance to develop a particular disease.	4.27	0,850
	All of the serious diseases is heredity diseases.	3.88	1.077
	A healthy parent will have a child with heredity diseases.	3.85	1.130
Mental Well-Being	I am optimistic about the future.	3.99	1.042



	I feel useful.	4.07	2.342
	I feel relaxed.	4.18	0.892
	I am interested in other people.	4.10	0.994
	I can handle the problem well.	4.14	0.875
	I can think clearly.	4.21	0.907
	I can make my own decisions.	4.29	0.871
Healthy Lifestyle	I smoke regularly.	2.57	1.712
	I sleep between 7 to 8 hours daily.	3.81	1.249
	I eat breakfast, lunch, and dinner daily.	3.98	1.134
	I eat five portions of fruit and vegetables daily.	3.71	1.270

Table 2 illustrates the mean and standard deviation for the independent variable which is peer influence, disease, mental well-being and also the dependent variable which is adopting a healthy lifestyle. Firstly, Table 2 shows the mean and standard deviation for the items used to measure the variables of peer influences. Four questions were measured, with the highest mean being 4.20 for item PI1 with the statement “The influence of peers can affect my healthy lifestyle”. The items of PI4 are second highest with the statement “There are a few activities that related to peers' influence can affect my health“. Instead, with the lowest mean 4.17, items PI2 and PI3 both share the last place. PI2 statements are “ The influence of peers can be an important factor in adopting a healthy lifestyle. Meanwhile, PI3 statements are “The influence of peers is important in adopting a healthy lifestyle in my life”.

Next, Table 2 also shows the mean and standard deviation for the items used to measure the Heredity Disease. Seven questions were measured with the highest mean being 4.27 for item HD2, HD4 and HD5 with respectively on the statement “A genetic is a piece of DNA”, “Some diseases are caused by genetics, environment and lifestyle”, and “A genetic test can determine whether someone has a higher chance to develop a particular disease. It is followed by item HD1 and HD6 with both 3.88 means. Then, HD7 with 3.85 means, and lastly item HD3 with just 3.42 means only to be the lowest by statement “I can see genetics with the naked eye”.

Moreover, Table 2 shows the mean and standard deviation for the items used to measure Mental Well-being. There were also seven questions being measured with the highest mean being items MVB7 with 4.28 means by statement “I can make my own decisions”. Otherwise, the lowest mean, with 3.99 was for

MVB1 with the statement that “I am optimistic about the future”. The mean values for the other five items are respectively 4.21, 4.18, 4.14, 4.10 and 4.07 for item MVB6, MVB3, MVB5, MVB4, and MVB2 .

Lastly, Table 2 shows the mean and standard deviation for the items used to measure Healthy Lifestyle. Four questions were measured with the highest mean being 3.98 for the item HL3 on the statement “I eat breakfast, lunch, and dinner daily”. Otherwise, the lowest mean with 62.57 was for HL1 with the statement “I smoke regularly”. Meanwhile, the other mean for item HL2 and HL4 were 3.81 and 3.71 respectively.

### Result of Reliability Analysis

Table 3 below shows the Reliability Analysis of this study

Table 3: Reliability Analysis

Variable	Number of Items	Cronbach’s Alpha
Peer Influence	4	0.820
Heredity Disease	7	0.661
Mental Well-Being	7	0.686
Healthy Lifestyle	4	0.754

Table 3 shows the reliability analysis through Variables, Number of items and Cronbach’s Alpha. Based on the result of this table 3, Cronbach’s alpha coefficient indicates the values of the questionnaire were above the excellent reliability level of 0.60, with values in the range from 0.661 to 0.820. Peer Influence has been shown to have excellent reliability with four items which had Cronbach Alpha value of 0.820. Heredity Disease similarly showed very good reliability with 7 items and the Cronbach’s Alpha value of 0.661. After that, Mental Well-Being also showed very good reliability with 7 items equivalent to 0.686 Cronbach’s Alpha value. Lastly, the dependent variable, which is a Healthy Lifestyle, was shown to be very good of reliability with 4 items, and the Cronbach’s Alpha value was 0.754. To summarise, all of the variables included in the study have very good reliability and are acceptable. Thus, the data were considered suitable for further analysis.

### Result of Pearson Correlation Analysis

Table 4 below shows the Pearson Correlation Analysis of this Study.

Table 4: Pearson Correlation Analysis

Hypothesis	P-Value	Result (Supported/ Not Supported)
H <sub>1</sub> : There is a positive relationship between Peer Influence and adopting a Healthy Lifestyle.	0.165	H <sub>1</sub> is supported.
H <sub>2</sub> : There is a positive relationship between heredity disease and adopting a Healthy Lifestyle.	0.339	H <sub>2</sub> is supported.

H <sub>3</sub> : There is a positive relationship between mental well-being and adopting a Healthy Lifestyle.	0.553	H <sub>3</sub> is supported.
---	-------	------------------------------

---

Table 4 shows that Peer Influence and Healthy Lifestyle were significantly correlated at  $r = 0.165, p > 0.01$ . Similarly, the result shows a statistically significant correlation between Heredity Disease and Healthy Lifestyle with  $r = 0.339, p > 0.01$ . The third correlation is between Mental Well-being and Healthy Lifestyle, the result also shows a statistically significant correlation between them with  $r = 0.553, p > 0.01$ . According to the results, all the hypotheses were supported at a 0.01 significance level.

## DISCUSSION & RECOMMENDATIONS

In general, this study has discussed extensively about adopting a Healthy Lifestyle Practice, it's a choice among communities in Malaysia. Therefore, the study has figured out the relationship between three variables: peer influence, heredity disease and mental well-being with adopting a healthy lifestyle. Correspondingly, the previous research showed a significant relationship between peer influence, heredity disease and mental well-being with adopting a healthy lifestyle. However, based on the previous study, there are several factors that affect communities in Malaysia to adopt a healthy lifestyle. Hence, there are some recommendations to the researchers for improving the research for future studies.

The first recommendation is that the researchers can use a variety of survey techniques to respond to the questionnaires. One of the survey techniques that the researchers can use to carry out the study is by using a qualitative method which is in person personal interviews. Besides that, the second recommendation is that the researchers need to expand more methodological work in his study as a research reference. This research can be qualitatively by observing and looking at the people who perform such activities. Lastly, this study was significant for future researchers for better insight and knowledge. Future researchers should conduct the research topic focusing on adopting a Healthy Lifestyle Practice, it's a choice among communities in Malaysia.

## CONCLUSION

The primary purpose of this research is to examine the relationship between peer influence, heredity disease, and mental well-being with adopting a healthy lifestyle. The Malaysian community was selected as the respondents of this study. The data from the survey was analysed using the SPSS and Demographic analysis, Descriptive analysis, Reliability analysis and Pearson Correlation analysis. According to the results, all independent variables: peer influence, heredity disease, and mental wellbeing had a positive relationship with the dependent variables' healthy lifestyle. All the hypotheses were supported at a 0.01 significance level. Thus, all the hypotheses such as H<sub>1</sub>, H<sub>2</sub>, and H<sub>3</sub> stated are accepted.

## REFERENCES

- Ahmad Ali (2019, July 31). Pengaruh Rakan Sebaya Dalam Pembentukan Sahsiah Remaja. <https://ahmadalikarim.wordpress.com/2019/07/31/pengaruh-rakan-sebaya-dalam-pembentukan-sahsiah-remaja/>
- Akter, M., Sadekin, M. N., & Patwary, A. K. (2020). An Empirical Study on Students' Satisfaction from Mawlana Bhashani Science & Technology University, Bangladesh. *Review of Economics and Development Studies*, 6(2), 363-379.
- Alicia Tuovilla. (2020 May 28) Sampling: What It Is, Different Types, and How Auditors and Marketers Use It. <https://www.investopedia.com/terms/s/sampling.asp>
- Alom, S., Patwary, A. K., & Khan, M. M. H. (2019). Factors affecting the turnover intention of Bangladeshi migrants in the United Arab Emirates: An empirical study on the hotel industry. *International Journal of Innovation, Creativity and Change*, 8(3), 344-360.
- Alvarez-Alvarez, M., de la Vega-Marcos, R., Jiménez-Castuera, R., & Leyton-Román, M. (2021). Psychometric Properties of the Healthy Lifestyle Questionnaire for Ecuadorian University Students (EVS-EUE). *International Journal of Environmental Research and Public Health*, 18(3), 1087.
- Ann (2021, October 28) Reachout.my. <https://www.reachout.my/tekanan-rakan-sebaya-dan-kesannya-terhadap-kesihatan-mental/>
- Awadah, S. (2019, October 10). 5 Keburukan Makanan Segera Yang Ramai orang Sengaja buat Tak Nampak. Bidadari.My. <https://bidadari.my/keburukan-makanan-segera/>
- Charles B. Corbin. (2022). *Health Opportunities Through Physical Education*. America: Human Kenetics Publishers.
- Chi, Yen. (2007) Pengaruh Rakan Sebaya. <https://www.scribd.com/document/358356649/Pengaruh-Rakan-Sebaya>
- Dan G. Blazer & Lyla M. Hernandez. (2017). *Genes, Behavior, and The Social Experiment: Moving Beyond the Nature / Nurture Debate*. Washington: The National Academy Press Publishers.
- Edward P. Sarafino & Timothy W. Smith. (2022). *Health Psychology: Biopsychosocial Interactions*. America: Library of Congress Cataloging.
- Explorable.com. (2009, November 15). *Research population*. Explorable - Think Outside The Box - Research, Experiments, Psychology, Self-Help. <https://explorable.com/research-population>
- Farhud DD. (2015). Impact of Lifestyle on Health. *Iranian Journal of Public Health* 44 (11): 1442-1444.
- Fengmin, Z., Baijun, W., Jiangtao, B., Li, L., & Patwary, A. K. (2022). Investigating revisit intention of medical tourists in China through nutritional knowledge, perceived medical quality, and trust in the physiologist: A recommendation on health tourism policy measures. *Frontiers in Public Health*, 10, 893497.
- Hassan, T. (2009). User-guided wrapping of PDF documents using graph matching techniques. *2009 10th International Conference on Document Analysis and Recognition*. <https://doi.org/10.1109/icdar.2009.238>
- Hazbar, A. M. H., alem Mohammed, A., & Karim, A. K. A. (2019). An Empirical Study of Factors Influencing hotel customers' online booking Intention. *مجلة العلوم التربوية و الدراسات الإنسانية*, (5), 1-17. <https://ddeku.edu.in/Files/2cfa4584-5afe-43ce-aa4b-ad936cc9d3be/ustom/Sam>
- Isa, A. M. (2022, November 2). *Bersenam Untuk Kesehatan mental*. Hello Doktor. <https://hellodoktor.com/kecergasan/motivasi-bersenam/bersenam-untuk-kesihatan-mental/>
- Jaquann, L. (2019). *Child Psychology*. London: ED-Tech Press Publishers.
- John W. Creswell & J. David Creswell. (2018). *Research Design: Qualitative, Quantitative, and Mixed Methods Approaches*. London: SAGE Publisher.

- Joseph F. Hair. (2015). *Essentials of Business Research Methods*. England: Library of Congress Cataloging.
- Kirti. (2022, January 31). *Research design | Definition, features, types, process, importance & factors affecting research design*. Top4u. <https://www.toppers4u.com/2022/01/research-design-definition-features.html>
- Krishnan, M., & A. Rahim, S. (2015). Hubungan Kait Komunikasi Kesehatan Dengan Kesan Hirarki Isu Kesehatan Terhadap Perubahan Amalan Gaya Hidup Sihat (The relationship of health communication with the hierarchy of effect in health issues towards healthy lifestyle). *Jurnal Komunikasi, Malaysian Journal of Communication*, 31(1), 297-326. <https://doi.org/10.17576/jkmjc-2015-3101-16>
- Leavy, P. (2022). *Research Design: Quantitative, Qualitative, Mixed Methods, Arts-Based, and Community-Based Participatory Research Approaches*. New York: A Division of Guilford Publishers.
- Li, L., Ragavan, N. A., Patwary, A. K., & Baijun, W. (2022). Measuring patients' satisfaction toward health tourism in Malaysia through hospital environment, nutritional advice, and perceived value: A study on Chinese exchange students. *Frontiers in public health*, 10, 893439.
- Li, L., Wu, B., & Patwary, A. K. (2022). How marine tourism promote financial development in sustainable economy: new evidences from South Asia and implications to future tourism students. *Environmental Science and Pollution Research*, 29, 1155-1172.
- Li, L., Wu, B., & Patwary, A. K. (2022). The psychosocial factors affecting chinese Outbound Exchange and mobility students' academic performance during COVID-19. *Frontiers in psychology*, 13, 872516.
- MacLeod, A. (2017). Prospection, well-being, and mental health. *Prospection, well-being, and mental health*, 255-274. <https://doi.org/10.1093/med:psych/9780198725046.003.0011>
- Nisreen, Nadiah. (2021, July 26) Apa Itu Pengaruh Rakan Sebaya? Ibu Ayah, Jika Anda Ada Anak Remaja. <https://hellodokter.com/keibubapaan/remaja/kesehatan-mental-remaja/pengaruh-rakan-sebaya/>
- Panke, D. (2018). *Research Design & Method Selection: Making Good Choices in the Social Sciences*. Dublin: International Political Science Review.
- Patwary, A. K., Roy, B., Hoque, R., & Khandakar, M. S. A. (2019). Process of developing a community based tourism and identifying its economic and social impacts: An Empirical study on Cox's Bazar, Bangladesh. *Pakistan Journal of Humanities and Social Sciences*, 7(1), 1-13.
- Professor, B. (2021). *Genetic Disorders | Heredity, Genes and Chromosomes*. New York: Speedy LLC Publishers.
- S, R. A. (2021, July 27). *Population vs sample: Definitions, and differences [Updated]*. Simplilearn.com. <https://www.simplilearn.com/tutorials/machine-learning-tutorial/population-vs-sample#what-is-population>
- Shona McCombes. (2019, September 19) Sampling Methods | Types, Techniques & Examples. <https://www.scribbr.com/methodology/sampling-methods/>
- Stewart-Brown, S. (2012). The Warwick-Edinburgh mental well-being scale (WEMWBS): Performance in different cultural and geographical groups. *Mental Well-Being*, 133-150. [https://doi.org/10.1007/978-94-007-5195-8\\_7](https://doi.org/10.1007/978-94-007-5195-8_7)
- Sumethokula, P., Patwary, A. K., Srinuanpanc, B., Srinuanpand, C., Suwandee, P., Thammathikul, A., & Phanong, W. (2020). The potential of new tour repackaging for creative tourism among entrepreneurs in Nakhon Si Thammarat. *International Journal of Innovation, Creativity and Change*, 13(10), 1752-1771.

- Wang, K., Ma, W., Wu, K., Ogino, S., Chan, A. T., Giovannucci, E.L., & Song, M. (2021). Healthy Lifestyle, endoscopic screening, and colorectal cancer incidence and mortality in the United States: A nationwide cohort study. *PLOS Medicine*, 18(2). doi:10.1371/journal.pmed.1003522
- Wani, R. (n.d.). *Population and sample*. Directorate of Distance Education | University of Kashmir.
- Wayne K. Hoy & Curt M. Adams. (2015). *Quantitative Research in Education: A Primer*. America: SAGE Publishers.
- Wu, B., Liu, S., Wang, J., Tahir, S., & Patwary, A. K. (2021). Assessing the mechanism of energy efficiency and energy poverty alleviation based on environmental regulation policy measures. *Environmental Science and Pollution Research*, 28, 40858-40870.
- Wu, B., Zhai, B., Mu, H., Peng, X., Wang, C., & Patwary, A. K. (2021). Evaluating an economic application of renewable generated hydrogen: A way forward for green economic performance and policy measures. *Environmental Science and Pollution Research*, 1-15.

# The Involvement in Physical and Fitness Activities Among Community in Malaysia

Nur Asma Nazihah Binti Adull Hamid, Nur Athirah Binti Abdullah, Siti Nur Hadaina Binti Rajab, Nurul Atikah Binti Mohd Razali, and \*Dr. Aifa Rozaini Mohd Radzol

Faculty of Hospitality, Tourism and Wellness, Universiti Malaysia Kelantan  
Corresponding email : [aifa.r@umk.edu.my](mailto:aifa.r@umk.edu.my)

---

## ABSTRACT

*Physical activity refers to a person's movements, which include leisure activities, travel from one point to another, and work. Participation in physical and fitness activities has grown in popularity among Malaysians. This problem statement is mostly concerned with health issues. People who suffer from health issues such as obesity tend to engage in less physical and fitness activity. This research about community involvement towards physical and fitness activities. The research was conducted among communities that are basically doing physical and fitness activities. Therefore, this study aimed to examine the relationship between reduce stress, lose weight, sleep and involvement factors with physical and fitness activities. When it comes to finding information, community in Malaysia from 18 to 26 years old and above appear for identifying involvement factors in physical and fitness activities among communities in Malaysia. 200 respondents were participated in this study which was conducted through social media like Google Form, WhatsApp, Facebook, and Instagram. The result showed that reduce stress, lose weight, and sleep influence the involvement in physical and fitness activities.*

**Keywords:** *Involvement in physical and fitness activities, Community in Malaysia, Social media, Involvement*

---

## INTRODUCTION

"Physical activity" includes any skeletal muscle-driven body movements that require energy. All of a person's movements, including doing leisure activities, travel, and work are considered physical activity. Physical activity can prevent and treat noncommunicable diseases like heart disease, stroke, diabetes, and some cancers. It prevents hypertension, maintains a healthy weight, and improves mental health, quality of life, and well-being. Walking, cycling, and leisure activities keep people active.

The action of participating in something or communicating with someone is characterised as involvement. According to Collins Dictionary (2022), participation is the excitement that people feel when they have a deep passion for something. According to the Cambridge Dictionary (2022), involvement involves participating in something, either actively or passively. In this study, engagement is defined as actively or passively participating in anything. The purpose of this study was to find out what variables motivate people to participate in physical and fitness activities. The following were the study's research objectives:

1. To determine the relationship between reducing stress and involvement factors with physical and fitness activities.
2. To examine the relationship between lose weight and involvement factors with physical and fitness activities.
3. To determine the relationship between sleep and involvement factors with physical and fitness activities.

## **SIGNIFICANCE OF THE STUDY**

### **Researchers**

This study can help the researcher understand why stress, weight loss, and sleep can measure physical and fitness activity. Next, this study will reveal a crucial feature of involvement that many researchers missed. This research paper topic might benefit future researchers.

### **Generation Z**

Gen Z is often referred to as the iGeneration or the centenary generation. People born between 1997 and 2012 comprise Generation Z, the generation that comes after the millennials. Many members of this generation's oldest cohort, who grew up during the era of ubiquitous internet access, will have completed their formal schooling and be ready to enter the workforce by 2020 (Meola, 2022). Generation Z will be exposed to greater physical and fitness activities as a result of this study.

## **LITERATURE REVIEW**

### **Reduce Stress**

The stress symptom occurs when a person believes that the need exceeds his ability or resources. According to Berretz et al. (2020), stress is a long-term physical and psychological tension that might impair a person's ability to deal with a situation. Marksberry (2017) has given a new meaning to stress by demonstrating in his work that stress may induce sickness and that an overdose can result in death. According to Kubala (2022), physical activity and fitness can lower stress by claiming that jogging for 10 minutes is equivalent to 45 minutes of physical exercise. A quick walk or any other modest physical activity can bring relief for several hours, despite the fact that it is only a brief effect. This demonstrates that physically active people had lower levels of stress and sadness than inactive people.

Physical activity and fitness, according to Madell (2012), can boost blood flow and improve an individual's body's ability to use oxygen. Both alterations have an immediate influence on the brain.



Regular exercise not only reduces stress but also promotes overall health in other ways. Stress levels may be reduced gently as a result of general health improvements. When a person improves their physical wellbeing and cardiac health, they will feel less stressed.

## **Lose Weight**

Body weight includes water, protein, minerals, and fat, according to In Body India (2020). Healthy and energetic people must maintain a balanced body composition. Weight loss reduces water, lean body mass, muscle mass, and fat mass. Warrier and Incze (2021) say a balanced, low-calorie diet and exercise are the safest and most effective ways to lose weight. This diet and 150 minutes of moderate-intensity physical activity each week can have several health benefits. The most important thing is to return to your weight loss strategy, which, like your diet, should be healthy and body-friendly.

Petridou et al. (2019) found that self-reported and objective measures of physical activity positively correlate with long-term weight reduction maintenance. Weight-maintainers burned 2621 kcal per week. This is more than 60 minutes of moderate-intensity exercise per day, like brisk walking, or 35 minutes of strenuous exercise, like jogging. Weight loss maintenance differed significantly between workout groups. They expended 2500 kcal per week (corresponding to 75 minutes of daily walking) while the standard behavioural therapy group expended 1000 kcal (equal to 30 minutes of daily walking) during 12 months (8.5 kg vs. 6.1 kg) and 18 months (6.7 kg vs. 4.1 kg). The researchers confirm prior findings that considerable physical activity increases lead to long-term weight decrease.

## **Sleep**

Hawkins (2014) defines sleep as a natural state of rest in which one is unconscious and muscles relax. Nightly sleep needs vary. Taking a bath, listening to music, or doing yoga before bed may help people sleep better. Daytime activity helps people fall asleep at night. Green (2022).

“What’s the difference” (2021) states that sweating after exercise can help people sleep better. Wang & Boros (2021) found that moderate exercise improves sleep quality for all ages. Gupta & Hussain (2020) found that people who exercise sleep better. However, longer bedtimes, delayed initiation of sleep, lower nighttime sleep duration, and greater daytime napping during lockdown have all linked to a decline in physical activity and fitness.

## **Involvement**

The action of participating in something or interacting with someone, according to Oxford Learners Dictionaries (2022), is a definition of involvement. According to Collins Dictionary (2022), involvement is the excitement that people feel when they have a deep passion for something. According to the Cambridge Dictionary (2022), involvement involves participating in something, either actively or passively. In this study, engagement is defined as actively or passively participating in anything.

Physical activity, according to Sekulic et al., (2020), can benefit people in a variety of ways, including those directly related to the prevention of obesity, type 11 diabetes, colon cancer, and cardiovascular problems. As a result, even while some types of physical activity have been shown to be beneficial for persons with serious health problems, achieving the recommended levels of physical activity remains a major public health issue. According to Tosho Bakinde (2022), a healthy lifestyle should include frequent physical activity because it maintains the body fit. Physical activity has several rewards. Physical activity, for example, enhances both physical and mental well-being. Physical fitness lowers the risk of getting generative diseases such as diabetes, hypertension, cancer, and heart disease. It also makes ordinary tasks such as lifting goods easier.

### **Research Hypothesis**

This study investigates the relationship among these discussed variables. Based on the literature discussed, the hypotheses of this study were summarized in the following manner:

**H<sub>1</sub>** : There is a positive relationship between reducing stress and involvement with physical and fitness activities.

**H<sub>2</sub>** : There is a positive relationship between lose weight and involvement with physical and fitness activities.

**H<sub>3</sub>** : The quality of people's sleep correlates positively with their level of activity.

### **Research Framework**

The Figure 1 below shows the research framework used for this study.

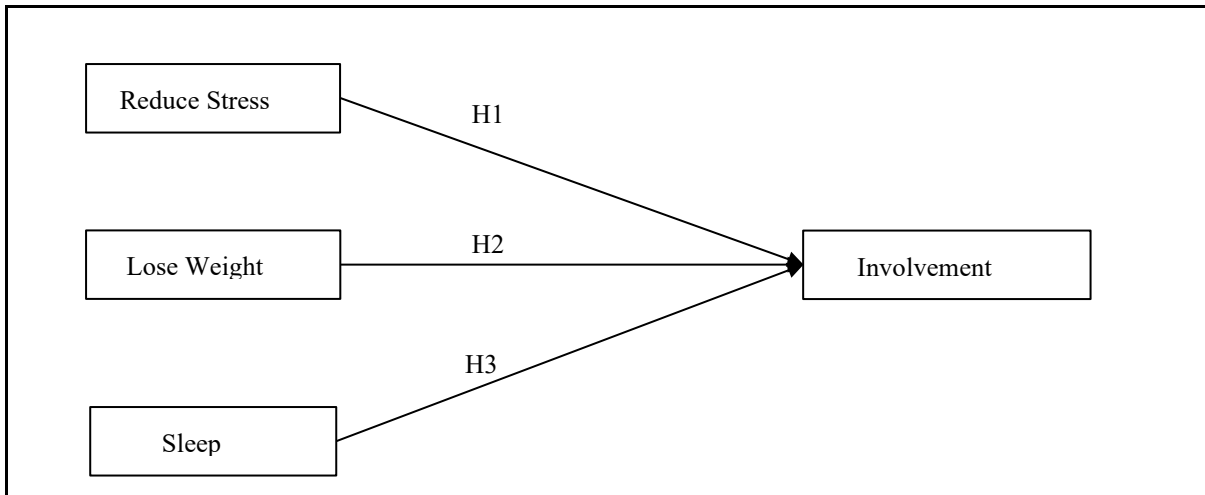

Figure 1 : Research Framework

## METHODOLOGY

### Research Design

McCombes (2021) describes a research design as "an organised strategy for gathering, analysing, and interpreting data to address a research issue." A well-designed study can ensure that the research's methods achieve its goals and that the data is properly analysed. Quantitative or qualitative investigations are possible. This study will use quantitative methods. Quantitative research is fast, scientific, and approachable, thus researchers decide on it. Quantitative research is convenient and fast, hence many researchers choose it (Williams, 2021).

### Data Collection

This study used "primary data." This study's data was gathered using an online questionnaire. The entire poll was distributed via social media platforms such as Google Forms, WhatsApp, Facebook, and Instagram. The questionnaire was distributed in April 2023. Randomly selected respondents completed the online questions. Malaysians who like fitness are the biggest source of respondents. Thus, Section B had filter questions. Qualified participants can fill out the questionnaire.

### Sampling

This study used convenience and non-probability sampling. Questionnaires will be preserved to respondents in Kota Bharu, Kelantan, in order for them to respond. The researcher will inquire whether the respondent is aware of the elements associated with physical exercise and fitness. This is a method of learning about the advantages of this involvement for personal wellness.

### Data Analysis

This study analyses data using SPSS. SPSS can describe and correlate independent and dependent variables. The programme enables academics to execute advanced statistical analysis on massive datasets. Next, frequency, descriptive, reliability, and correlation data analysis methods will be discussed.

## FINDINGS

### Result of Frequency Analysis

Table 1 below shows the Frequency Analysis of this study

Table 1 : Frequency Analysis

Characteristics	Frequency	Percentage
<b>Gender</b>		
Male	132	66.0%
Female	67	33.5%
<b>Age</b>		
18-19 years old	8	4.0%
20-21 years old	10	5.0%
22-23 years old	144	72.0%
24-25 years old	20	10.0%
26 years old and above	18	9.0%

Table 1 above shows the gender distribution where most respondents were male 66.0% (n=132) while the rest were female with 33.5% (n = 67). Besides that, the highest number of respondents were from 22 to 23 years old, with 72.0% (n = 144). The second highest number of respondents are from 24 to 25 years old, with 10.0% (n = 20). At the same time, the third highest number of respondents are from 26 years old and above, with 9.0% (n = 18). Next, the age group of 20 to 21 years old recorded 5.0% (n = 10) while the lowest number of respondents were from 18 to 19 years old, with 4.0% (n = 8).

### Result of Descriptive Analysis

Table 2 below shows the descriptive analysis

Table 2 : Descriptive Analysis

Variable	Items	Mean Score	Standard Deviation
Reduce Stress	1. Exercise can reduce stress.	4.22	898
	2. I feel relaxed physically and mentally by exercising.	4.08	915
	3. I can think positively if I do the exercise.	4.04	940
	4. My feelings and emotions will be control by the exercise	3.98	1.012
Weight Loss	1. I use specific goals and methods for weight loss.	3.88	1.006
	2.. I use weight-loss aids as apps, equipment, or diet foods to help me lose weight.	3.72	1.090
	3. I have many ways to boost my motivation to lose weight.	3.79	0.966
	4. I try to lose weight by myself or more people	3.84	0.995

	5. I go to a weight-loss group or program or have recently talked to a professional about losing weight..	3.27	1.263
Sleep	1. Exercise can benefit people's sleep.	4.10	977
	2. Exercise can increase an individual's sleep duration and the amount of slow wave sleep (SWS).	3.88	1.002
	3. I can get a better sleep when do a simple relaxation exercises or meditation before bed.	3.96	942
	4. Physical activity is impacted by the irregular sleep pattern.	3.93	946
	5. Physical exercise can help people who have sleep problems or insomnia.	3.90	995
Involvement	1. I speak one hour for walking activities in a day.	3.64	1.135
	2. I do physical activities like skipping, jogging, and yoga at home.	3.53	1.190
	3. I engage in physical activity while listening to music at home.	3.96	

Table 2 displays the frequency, mean score, and standard deviation for weight loss measurement items. The highest mean was 3.88 for item WL1: "I use specific goals and methods for weight loss". 200 responses slightly strongly disagree, disagree, not sure, agree, and strongly agree on WL1. Items LW5 on "I go to a weight-loss group or programme or have recently talked to a professional about losing weight" had the lowest mean, 3.27. WL2, WL3, and WL4's other three items averaged 3.72, 3.79, and 3.84.

Table 2 illustrates the frequency, mean, and standard deviation of sleep items. Five items were measured, with item S1's statement "Exercise can give a benefit people's sleep" having the highest mean of 4.10. The lowest mean score is shown in Table 2. Four questions were measured with item RS1 on "Exercise can reduce stress" having the highest mean of 4.22. 200 responses slightly strongly disagree, disagree, not sure, agree, and strongly agree on RS1. Item RS4, "My feelings and emotions will be controlled by the exercise," had the lowest mean, 3.98. The item S2 on "Exercise can increase an individual's sleep duration and amount of slow wave sleep (SWS)" had a mean score of 3.88. S3, S4, and S5's other three items averaged 3.96, 3.93, and 3.90.

Lastly, item frequency, mean, and standard deviation measured involvement. Three questions had the highest mean, 3.96 for item I3 on "I engage in physical activity while listening to music at home". Item I2, "I do physical activities like skipping, jogging, and yoga at home," has the lowest mean score of 3.53. Other I1 items averaged 3.64.

### Result of Reliability Analysis

Table 3 below shows the results of the reliability analysis.

Table 3 : Reliability Analysis

Variable	Number of items	Cronbach's Alpha
Reduce Stress	4	0.922
Weight Loss	5	0.889
Sleep	5	0.923
Involvement	3	0.773

Table 3 shows that Cronbach's Alpha values of the questionnaire were above the excellent reliability level of 0.70, with values in the range from 0.888 to 0.922. Reduce stress has been shown to have an excellent reliability with four items ( $\alpha = 0.922$ ). Weight loss similarly showed very good reliability with five items and Cronbach's Alpha value is  $\alpha = 0.889$ . Next, sleep also shows a good reliability with five items and Cronbach's Alpha value is  $\alpha = 0.923$ . For dependent variables, which is involvement, shows good reliability with three items and Cronbach's Alpha value is  $\alpha = 0.773$ . To summarize, all of the variables included in the study have very good reliability and are acceptable. Thus, the data were considered suitable for further analysis.

### Result of Pearson Correlation Analysis

Table 4 below shows the Pearson Correlation Analysis.

Table 4 : Pearson's Correlation Analysis

Hypothesis	P-Value	Result (Supported/ Not Supported)
<b>H1</b> : There is a positive relationship between reducing stress with physical and fitness activities community In Malaysia.	0.597	H <sub>1</sub> is supported
<b>H2</b> : There is a positive relationship between lose weight with physical and fitness activities community in Malaysia	0.528	H <sub>2</sub> is supported
<b>H3</b> : There is a positive relationship between sleep with physical and fitness activities community in Malaysia	0.532	H <sub>3</sub> is supported

Table 4 shows that reduce stress and involvement were significantly correlated at  $r = 0.597$ ,  $p < 0.01$ . Similarly, the results show a statistically significant correlation between weight loss and involvement with  $r = 0.528$ ,  $p < 0.01$ . The third correlation is between sleep and involvement with  $r = 0.532$ ,  $p < 0.01$ . According to the results, all hypotheses were supported at 0.01 significance level.

## DISCUSSION AND RECOMMENDATION

In general, this study has extensively researched factors of the involvement in physical and fitness activities among communities in Malaysia. The study has figured out the relationship between three variables : reduce stress, lose weight, sleep with involvement in physical and fitness activities.

For the benefit of future researchers, they may be able to recommend additional variables related to this broader scope of physical activity and fitness to pursue new findings in their studies. Next, the scope of the research was limited to include only 200 samples that could be evaluated in terms of the main target. It has been determined that the current sample size of this size is sufficient for the purposes of this study.

However, to get 200 respondents, the researcher needs to take a long time because there are some people in Malaysia who think that answering online questionnaires will be a waste of their time. In conclusion, the interview method, or the creation of several open questions for respondents should be used in the future instead of asking respondents to answer online questionnaires. With this, the researcher will have a better chance of getting a high response rate if using the method. This method will also save the researcher's time to satisfy the respondents.

## CONCLUSION

The main objective of this research is to examine the relationship between reduce stress, lose weight and sleep in involvement in physical and fitness activities. Community in Malaysia was selected as respondents of this study. The data from the survey was analysed using SPSS and descriptive analysis, reliability analysis and Pearson Correlation analysis were performed. According to the results, all independent variables, reduce stress, lose weight and sleep, significantly and positively influence the involvement in physical and fitness activities. Thus, all the hypothesis such as H1, H2 and H3 are supported.

## REFERENCES

- Ada beza ke bersenam waktu pagi atau petang? Jom ambil tahu. (2021). mStar. <https://www.mstar.com.my/xpose/mode/2021/10/16/ada-beza-ke-bersenam-waktu-pagi-atau-petang-jom-ambil-tahu>
- Akter, M., Sadekin, M. N., & Patwary, A. K. (2020). An Empirical Study on Students' Satisfaction from Mawlana Bhashani Science & Technology University, Bangladesh. *Review of Economics and Development Studies*, 6(2), 363-379.
- Alom, S., Patwary, A. K., & Khan, M. M. H. (2019). Factors affecting the turnover intention of Bangladeshi migrants in the United Arab Emirates: An empirical study on the hotel industry. *International Journal of Innovation, Creativity and Change*, 8(3), 344-360.
- Berretz, G., Wolf, O. T., Güntürkün, O., & Ocklenburg, S. (2020). Atypical lateralization in neurodevelopmental and psychiatric disorders: What is the role of stress? *Cortex*, 125, 215–232. <https://doi.org/10.1016/j.cortex.2019.12.019>
- Bhandari, P. (2020, May 14). Population vs. Sample | Definitions, Differences & Examples. Scribbr. <https://www.scribbr.com/methodology/population-vs-sample/>
- Bhardwaj, P. (2019). Types of sampling in research. *Journal of the Practice of Cardiovascular Sciences*, 5(3), 157. [https://doi.org/10.4103/jpcs.jpcs\\_62\\_19](https://doi.org/10.4103/jpcs.jpcs_62_19)
- Cherney, K. (2018, January 23). 30 Ways Stress Can Affect Your Body. Healthline; Healthline Media. <https://www.healthline.com/health/facts-about-stress>
- Data analysis. (2022). In Wikipedia. [https://en.wikipedia.org/wiki/Data\\_analysis](https://en.wikipedia.org/wiki/Data_analysis)
- Every-Palmer, S., Huthwaite, M. A., Elmslie, J. L., Grant, E., & Romans, S. E. (2018). Long-term psychiatric inpatients' perspectives on weight gain, body satisfaction, diet and physical activity: a mixed methods study. *BMC Psychiatry*, 18(1). <https://doi.org/10.1186/s12888-018-1878-5>
- Feifei Wang & Szilvia Boros (2021) The effect of physical activity on sleep quality: a systematic review, *European Journal of Physiotherapy*, 23:1, 11-18, <https://doi.org/10.1080/21679169.2019.1623314>
- Fengmin, Z., Baijun, W., Jiangtao, B., Li, L., & Patwary, A. K. (2022). Investigating revisit intention of medical tourists in China through nutritional knowledge, perceived medical quality, and trust in



- the physiologist: A recommendation on health tourism policy measures. *Frontiers in Public Health*, 10, 893497.
- Green E. (2022). A Bedtime Routine For Adults: 10 Calming Activities. <https://www.nosleeplessnights.com/bedtime-routine-for-adults/>
- Gupta R. & Arshad Hussain (2020). Changes in sleep pattern and sleep quality during COVID-19 lockdown.
- Hawkins J.M. (2014). Sleep. In *Kamus Dwibahasa Oxford Fajar*. Oxford, England: Oxford University Press. <https://www.ncbi.nlm.nih.gov/pmc/articles/PMC7597722/>
- Hazbar, A. M. H., Alem Mohammed, A., & Karim, A. K. A. (2019). An Empirical Study of Factors Influencing hotel customers' online booking Intention. *مجلة العلوم التربوية و الدراسات الإنسانية*, (5), 1-17.   
<https://www.healthline.com/health/heart-disease/exercise-stress-relief>  
<https://www.healthline.com/health/heart-disease/exercise-stress-relief>
- Hussain, J., & Ali, M. (2021). Sampling and differences between Probability and non Probability sampling techniques Department; Psychology, Hazara University Mansehra Pakistan. *Majeed Ali Jan. in Malaysia: Are We Doing Enough? Findings from the REDISCOVER Study*. 19(24),
- Kassiani Nikolopoulou. (2022, July 5). *What Is Probability Sampling? | Types & Examples*. Scribbr. <https://www.scribbr.com/methodology/probability-sampling/>
- Kubala, J. (2022, January 20). 15 Simple Ways to Relieve Stress. Healthline; HealthlineMedia. <https://www.healthline.com/nutrition/16-ways-relieve-stress-anxiety#1.-Get-more-physical-activity>
- Langhammer, B., Bergland, A., & Rydwick, E. (2018). The Importance of Physical Activity Exercise among Older People. *BioMed Research International*, 2018, 1–3. <https://doi.org/10.1155/2018/7856823>
- Lani J. (2022). Pearson's Correlation Coefficient. <https://www.statisticssolutions.com/free-resources/directory-of-statistical-analyses/pearsons-correlation-coefficient/>
- Li, L., Ragavan, N. A., Patwary, A. K., & Baijun, W. (2022). Measuring patients' satisfaction toward health tourism in Malaysia through hospital environment, nutritional advice, and perceived value: A study on Chinese exchange students. *Frontiers in public health*, 10, 893439.
- Li, L., Wu, B., & Patwary, A. K. (2022). How marine tourism promote financial development in sustainable economy: new evidences from South Asia and implications to future tourism students. *Environmental Science and Pollution Research*, 29, 1155-1172.
- Li, L., Wu, B., & Patwary, A. K. (2022). The psychosocial factors affecting Chinese Outbound Exchange and mobility students' academic performance during COVID-19. *Frontiers in psychology*, 13, 872516.
- Madell, R. (2012, April 10). Exercise as Stress Relief. Healthline; Healthline Media.
- Maizatullifah Miskan, Najmin Abu-Bakar, & Khalid Yusoff. (2022). *Physical Activity*
- Marksberry, K. (2017, January 4). What is Stress? - The American Institute of Stress. The American Institute of Stress. <https://www.stress.org/what-is-stress>
- McCombes S. (2021). What Is a Research Design | Types, Guide & Examples. <https://www.scribbr.com/methodology/research-design/>
- Meola A. (2022). Generation Z News : Latest characteristics, research, and facts. <https://www.insiderintelligence.com/insights/generation-z-facts/>
- Patwary, A. K., Roy, B., Hoque, R., & Khandakar, M. S. A. (2019). Process of developing a community based tourism and identifying its economic and social impacts: An Empirical study on Cox's Bazar, Bangladesh. *Pakistan Journal of Humanities and Social Sciences*, 7(1), 1-13.

- Petridou, A., Siopi, A., & Mougios, V. (2019). Exercise in the management of obesity. *Metabolism*, 92(92), 163–169. <https://doi.org/10.1016/j.metabol.2018.10.009>
- quantilope. (2022). *How to Determine Sample Size for Quantitative Research*. Quantilope.com. <https://www.quantilope.com/resources/glossary-how-to-determine-sample-size-for-quantitative-research>
- Richards, J., Foster, C., Townsend, N., & Bauman, A. (2014). Physical fitness and mental health impact of a sport-for-development intervention in a post-conflict setting: randomised controlled trial nested within an observational study of adolescents in Gulu, Uganda. *BMC Public Health*, 14(1). <https://doi.org/10.1186/1471-2458-14-619>
- Saris, W. H. M., Blair, S. N., van Baak, M. A., Eaton, S. B., Davies, P. S. W., Di Pietro, L., Fogelholm, M., Rissanen, A., Schoeller, D., Swinburn, B., Tremblay, A., Westerterp, K.R., & Wyatt, H. (2003). How much physical activity is enough to prevent unhealthy weight gain? Outcome of the IASO 1st Stock Conference and consensus statement. *Obesity Reviews*, 4(2), 101–114. <https://doi.org/10.1046/j.1467-789x.2003.00101.x>
- Schultchen, D., Reichenberger, J., Mittl, T., Weh, T. R. M., Smyth, J. M., Blechert, J., & Pollatos, O. (2019). Bidirectional relationship of stress and affect with physical activity and healthy eating. *British Journal of Health Psychology*, 24(2), 315–333. <https://doi.org/10.1111/bjhp.12355>
- Sekulic, D., Blazevic, M., Gilic, B., Kvesic, I., & Zenic, N. (2020). Prospective Analysis of Levels and Correlates of Physical Activity during COVID-19 Pandemic and Imposed Rules of Social Distancing; Gender Specific Study among Adolescents from Southern Croatia. *Sustainability*, 12(10), 4072. <https://doi.org/10.3390/su12104072>
- SPSS. (2022). In Wikipedia. <https://en.wikipedia.org/wiki/SPSS>
- Sumethokula, P., Patwary, A. K., Srinuanpanc, B., Srinuanpand, C., Suwandee, P., Thammathikul, A., & Phanong, W. (2020). The potential of new tour repackaging for creative tourism among entrepreneurs in Nakhon Si Thammarat. *International Journal of Innovation, Creativity and Change*, 13(10), 1752-1771.
- Thivel, D., Tremblay, A., Genin, P. M., Panahi, S., Rivière, D., & Duclos, M. (2018). Physical Activity, Inactivity, and Sedentary Behaviors: Definitions and Implications in Occupational Health. *Frontiers in Public Health*, 6. <https://doi.org/10.3389/fpubh.2018.00288>
- Turner, D. P. (2020). Sampling Methods in Research Design. *Headache: The Journal of Head and Face Pain*, 60(1), 8–12. <https://doi.org/10.1111/head.13707>
- Warrier, G., & Incze, M. A. (2021). I Want to Lose Weight: Which Diet Is Best? *JAMA Internal Medicine*, 181(9), 1268. <https://doi.org/10.1001/jamainternmed.2021.3342>
- Williams T. (2021). Why Is Quantitative Research Important? <https://www.gcu.edu/blog/doctoral-journey/why-quantitative-research-important>
- World. (2022, October 5). *Physical activity*. Who.int; World Health Organization: WHO. <https://www.who.int/news-room/fact-sheets/detail/physical-activity>
- Wu, B., Liu, S., Wang, J., Tahir, S., & Patwary, A. K. (2021). Assessing the mechanism of energy efficiency and energy poverty alleviation based on environmental regulation policy measures. *Environmental Science and Pollution Research*, 28, 40858-40870.
- Wu, B., Zhai, B., Mu, H., Peng, X., Wang, C., & Patwary, A. K. (2021). Evaluating an economic application of renewable generated hydrogen: A way forward for green economic performance and policy measures. *Environmental Science and Pollution Research*, 1-15.

# **Preferences of Fast-Food Selection Among Third-Year Students of Bachelor Entrepreneurship (Wellness) with Honour at UMK City Campus.**

*Jeyageetha a/p Rajandran, Siti Nurul Aisyah binti Marzuki, Amir Hakim bin Abd Rahman, Nur Yasmin Balqis binti @ Rosliza, Suchi binti Hassan*

*Faculty of Hospitality, Tourism and Wellness, Universiti Malaysia Kelantan*

*Corresponding email:suchi.h@umk.edu.my*

---

## **ABSTRACT**

*Fast food is a type of food produced in large quantities for commercial resale, with a strong emphasis on quick service. It is commonly found in restaurants or stores, offering frozen, preheated, or precooked ingredients packaged for take-out or take-away purposes. Understanding the factors influencing fast food selection, such as delicious, preparation, and price, is crucial. This research specifically focuses on third-year students pursuing a Bachelor's degree in Entrepreneurship (Wellness) with honours at UMK City Campus. The study aims to collect data from a total of 161 respondents, with an expected target of 113 participants. The research methodology employed ensures a structured approach to ensure reliable and valid results. A study must have a clear purpose, maintain objectivity, and employ appropriate methods to yield the desired outcomes or answers.*

**Keywords: Fast Food Selection, Delicious, Preparation, Price**

---

## **INTRODUCTION**

Fast food, found in various establishments such as sit-down restaurants, counter service, take-out, drive-thru, and deliveries, is known for its quick preparation and service. It is popular due to its tastiness, accessibility, and convenience in the Health Guides (2022). However, it is important to note that fast food frequently relies on refined grains rather than whole grains and is often high in sodium for the purposes of flavor enhancement and preservation. Its nutritional value is generally lower compared to other foods, and it is frequently available at a low cost. Fast food is commonly associated with high levels of calories, fat, sodium, and sugar, while being deficient in essential vitamins, minerals, and nutrients. Common examples include burgers, pizza, French fries, fried chicken, and tacos.

According to Yong & Hee (2020), China's growth after joining the WTO in the early 2000s has been remarkable. The middle class has seen a significant increase in their consumption levels. Western-style fast food restaurants are rapidly expanding and gaining popularity among the younger population. This rise in competition poses a threat to Western fast food companies operating in China. Chinese consumers are becoming more discerning in their dining choices, considering factors like what, how, and where they eat. Consequently, both domestic and foreign businesses are facing inevitable competition. This trend extends beyond China to other countries like Malaysia, where fast food has become increasingly popular. Therefore, the goal of this study is to examine the preference of fast food selection among third-year students of Bachelor Entrepreneurship (Wellness) with honour at UMK City Campus. There were three objectives for this study:

1. To investigate the relationship with the delicious with the preference of fast food selection among third-year students of Bachelor Entrepreneurship (Wellness) with honour at UMK City Campus
2. To investigate the relationship between preparation with the preference of fast food selection among third-year students of Bachelor Entrepreneurship (Wellness) with honour at UMK City Campus
3. To investigate the relationship between price with the preference of fast food selection among third-year students of Bachelor Entrepreneurship (Wellness) with honour at UMK City Campus

## **SIGNIFICANCE OF THE STUDY**

The findings of this study are expected to provide knowledge and awareness about fast food. More importantly, this study will help students limit fast food consumption, give knowledge about fast food consumption to their bodies and make them more careful about food to be healthier. Addiction scholars and academic researchers will benefit from this research because it will provide them with fascinating insights that will be the basis for future research. Furthermore, this study will be a starting point for future studies on the same topic and issue related to the preference of fast food selection among third-year students of Bachelor Entrepreneurship (Wellness) with honour at UMK City Campus.

## **LITERATURE REVIEW**

### ***Delicious***

The deliciousness of food plays a crucial role as a determining factor for customers. Numerous research studies have emphasized the importance of food quality and its positive impact on purchase intention. When considering the effect of well-known food quality on customer retention, a significant body of literature emphasizes the joy experienced by customers when they receive exceptional service. According to Ma and Yang (2018), customers are likely to be satisfied when they purchase high-quality products. Therefore, there is a strong correlation between food quality and customer satisfaction, which in turn significantly influences consumer behaviour and loyalty.

Moreover, the quality of the cuisine has been recognized as a pivotal element in shaping the overall dining experience, as emphasized by Sulek and Hensley (2014). When it comes to food quality, purchasing intention significantly impacts the selection of restaurants. Susskind and Chan (2000) conducted a study revealing that the quality of the meal is the primary factor that drives individuals to visit fast food establishments. Fast food restaurants consider food quality as a fundamental factor in retaining customers. Sulek and Hensley (2014) concurred, stating that meal quality outweighs other restaurant-related factors, such as the environment and service quality, in influencing purchase intention. Consequently, fast food becomes the preferred choice for daily routine lunches among UMK students due to its excellent food quality.

## *Preparation*

Atkins and Bowler (2001) state that "fast food" often refers to fully prepared food to be eaten and then served rapidly, either on- or off-site. This means that to ensure that food is prepared safely and adequately for delivery, enterprises must comply with established standards for food preparation facilities, food prep tools, food transport vehicles, and people responsible for handling and preparing food. While any meal that requires little preparation is considered fast food, the term is frequently used to refer to food that is served to consumers in a packaged form for eating in or taking away from a restaurant or store and contains components that have already been heated or cooked.

In other words, lifestyle—which is defined as the collection of recurring patterns of behaviour that each person voluntarily and consciously adopts throughout their daily lives—reflects one's values, way of thinking, personal style, and ultimate goals (Vyncke, 2002). As a result, lifestyle has a significant impact on how people behave as consumers. Due to time restrictions, many students have shifted their eating habits to accommodate their hectic schedules, they switch from healthy, home-cooked meals to fast food. This is due to the fact that for many young adults, their college years represent a crucial time of change. Most students are currently living independently for the first time after leaving their parents' houses. These changing living arrangements may have an impact on lifestyle elements like dietary preferences, diet quality, and exercise routines (Brevard & Ricketts). As a group, college students are particularly susceptible to the intake of "convenience" food.

## *Price*

As stated by Jacoby and Olson (1977), price represents the subjective perception of the objective cost of a product for consumers. In the fast food industry, price plays a pivotal role in shaping purchase intentions. When making food choices, consumers are influenced by the price associated with a particular brand. Brands often establish their own pricing standards, setting them apart from competitors. Moreover, price exerts a significant influence on purchase intentions, as changes in pricing can greatly impact customers, as emphasized by Liew (2015). Furthermore, when customers find a price point that aligns with their affordability and satisfies them, it enhances their willingness to make regular purchases of products from that brand in the future. This rationale applies to third-year students pursuing a Bachelor's degree in Entrepreneurship (Wellness) with honours at UMK City Campus, as brand pricing influences their inclination towards selecting fast food options.

According to Yang and Mao (2014), the influence of a lower price on consumers' purchasing decisions is emphasized. Customers who are price-sensitive, as described by Wakefield and Inman (2003), actively strive to find the most affordable price available. If a student is on a budget, they may prefer lower-priced items such as burgers, fries, and soft drinks instead of more expensive items like steak or seafood. Moreover, if a fast food restaurant offers a lower price than its competitors, students may be more likely to purchase the item, as they feel like they are getting a better deal. Additionally, offering discounts and promotion can be a great way to entice students to purchase fast food items. These incentives can make UMK third-year students of Bachelor Entrepreneurship (Wellness) with honour feel like they are getting a good value, while also giving them an extra reason to try out a new product.

## Research Hypothesis

Based on a review of the literature three hypotheses have been developed. The hypotheses are:

H1: There is a positive relationship between the delicious and preference of fast food selection among third-year students of Bachelor Entrepreneurship (Wellness) with honour at UMK City Campus.

H2: There is a positive relationship between the preparation and preference of fast food selection among third-year students of Bachelor Entrepreneurship (Wellness) with honour at UMK City Campus.

H3: There is a positive relationship between the price and preference of fast food selection among third-year students of Bachelor Entrepreneurship (Wellness) with honour at UMK City Campus.

## Research Framework

### INDEPENDENT VARIABLE

### DEPENDENT VARIABLE

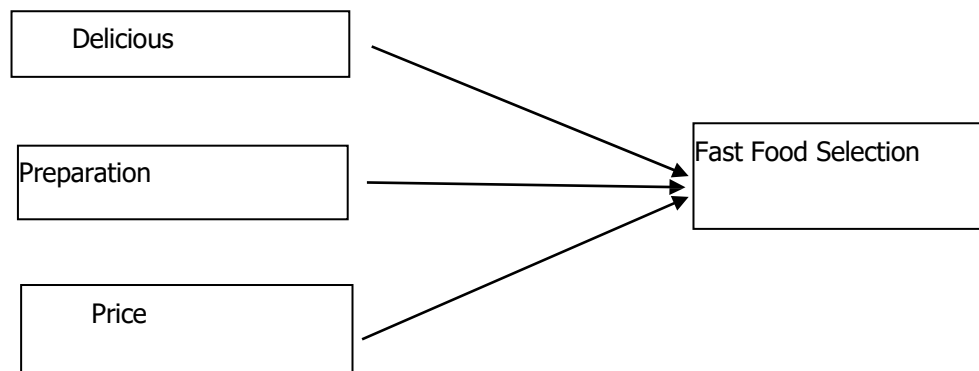

Figure 2.1: Conceptual Framework

Based on the literature review, a conceptual framework was developed to investigate the fast food selection preferences of third-year students pursuing a Bachelor's degree in Entrepreneurship (Wellness) with honours at UMK City Campus. Figure 2.1 presents the proposed conceptual framework, which includes three independent variables: delicious, preparations, and price. The dependent variable is the preference for fast food selection among the aforementioned student group. From this, it can be inferred that the independent variables are expected to exert an influence on the dependent variable in this study.

## **METHODOLOGY Research Design**

The researchers of this study using quantitative data methods to collect the data. Using quantitative data, the information can be collected quickly and easy to summarize the findings. Besides, the quantitative can also involve more respondent in one research study, than the qualitative data method.

### **Data Collection**

A questionnaire is a specific tool or instrument for collective data. This questionnaire will be assigned to third-year students of Bachelor Entrepreneurship (Wellness) with honour at the City Campus of UMK. The purpose of this research endeavour will be explained first before respondents answer the questions. This questionnaire will be distributed through online plat platforms like WhatsApp, which are more aware and exposed to this kind of platform.

### **Sampling**

Researchers used non-probability sampling techniques for this research. This is because non-probability sampling is best when a researcher wants to gain a greater understanding of a specific group of people or when it is challenging to establish a clear definition of the population of interest. Additionally, this sampling method is also proper when there is limited time and resources. Non-probability sampling can provide more in-depth and targeted information that may not otherwise be obtained through a probability sampling method.

### **Data Analysis**

The analysis involves a series of steps, including data examination, cleaning, transformation, and modelling. These processes assist in breaking down large volumes of data into meaningful and manageable fragments. To facilitate this, researchers often utilize SPSS (Statistical Package for the Social Sciences), which is a comprehensive software package that integrates various programs. SPSS is commonly employed for data analysis in the social sciences, including market research, surveys, and data mining. It enables researchers to analyse, transform, and identify patterns within different data variables, ultimately yielding valuable insights.

## FINDING

### Demographic Analysis

Table 1: Respondent Profile

Characteristics	Frequency	Percentage (%)
<b>Gender</b>		
Male	80	70.8
Female	33	29.2
<b>Age</b>		
19-21 years old	0	0
22-24 years old	113	100
25 years old above	0	0
<b>Marital Status</b>		
Single	110	97.3
Married	3	2.7
<b>Race</b>		
Malay	98	86.7
Chinese	3	2.7
Indian	10	8.8
Others	2	1.8
<b>Year of Study</b>		
Year 1	2	1.8
Year 2	0	0
Year 3	109	96.5
Year 4	2	1.8

Among the respondents, 80 individuals (70.8%) identified as female, while 33 individuals (29.2%) identified as male. In terms of age, the study included 113 respondents, all falling within the range of 22 to 24 years old, making up the highest percentage of respondents (100%). Among the respondents, 110 were single, accounting for the majority (97.3%), while 3 respondents were married (2.7%). In terms of racial distribution, Malay respondents constituted the largest group, with 98 individuals (86.7%). The second largest racial group was Indian, comprising 10 individuals (8.8%). Chinese respondents accounted for 3 individuals (2.7%), while other racial groups contributed 2 individuals (1.8%). Among the respondents, the highest representation was from students in their third year of study, totalling 109 individuals (96.5%). Both first and fourth-year students were represented by 2 individuals each (1.8%). Notably, there were no respondents from the second year of study.



## Result of Descriptive Analysis

Table 2: Descriptive Analysis

<b>Variables</b>	<b>Items</b>	<b>Mean Score (M)</b>	<b>Standard Deviation (SD)</b>
<b>Delicious</b>	The deliciousness increase the emotion of cheerfulness	3.61	.881
	The deliciousness increase the emotion of cheerfulness	3.63	.878
	The taste of fast food meets the taste of the middle class	3.42	.832
	The satisfaction of the deliciousness of fast food is guaranteed	3.47	.887
	The delicious taste of fast food can be shared with loved ones	3.65	.963
<b>Preparation</b>	Fast food is well prepared and neat	3.36	.955
	Fast food uses special plastic to easily carry food	3.50	.908
	Fast food provides a good variety of set menu options	3.52	.897
	Quick and time-saving food preparation	3.73	.887
	Fast food preparation is taken seriously by fast food restaurants	3.55	.886
<b>Price</b>	Promotions in fast food attract customers to buy	3.70	.875
	Fast food price is lower than other restaurants	3.34	.933
	Fast food option is seen as a good value for money	3.43	.877
	Fast food prices reflect the service quality of fast food restaurants	3.50	.846
	The price I pay for fast food guarantees my satisfaction	3.49	.857
<b>Fast Food Selection</b>	Fast food is easy to prepare	3.71	.831
	Fast food provides the latest menu	3.65	.864
	Fast food has the same quality and nutrients as other foods	3.16	.960
	Popularity of fast food getting increase due to easy and quick service	3.71	.903
	Eating too much fast food causes the risk of disease	3.60	.936

The result in Table 2 shows a descriptive analysis of independent variable which is delicious that shows the item " The delicious taste of fast food can be shared with loved ones" has the highest mean score (M=3.65, SD=.963) while the item " The taste of fast food meets the taste of the middle class" has the lowest mean score (M=3.42, SD=.832). The second independent variable which is preparation shows the item " Quick and time-saving food preparation " has the highest mean score (M=3.73, SD=.887) while the item " Fast food is well prepared and neat" shows the lowest mean score (M= 3.36, SD=.955). Next, the third independent variable which is price show the item " Promotions in fast food attract customers to buy " has the highest mean score (M=3.70, SD=.875), while the item "Fast food price is lower than other restaurants"(M=3.34, SD=.933). Lastly, for the dependent variable which is fast food

selection shows the item "Popularity of fast food getting increase due to easy and quick service" has the highest mean score (M=3.71, SD=.903). However, the item "Fast food has the same quality and nutrients as other foods" has the lowest mean score (M=3.16, SD=.960).

### Reliability Analysis

Table 3: Reliability Analysis

Variables	Cronbach's Alpha	No. of Items
Delicious	.773	5
Preparation	.729	5
Price	.717	5
Fast Food	.639	5

Table 3 showed the results of the reliability analysis based on the independent variable and dependent variable which include delicious (.773), preparation (.729), price (.717), and fast food (.639). According to Cronbach's Alpha coefficient scale, all these variables show acceptable coefficient.

### Pearson Correlation Analysis

Table 4: Pearson Correlation Analysis

Hypothesis	P-Value	Result
H1-There is a positive relationship between the delicious Preference of fast food selection among third-year students of Bachelor Entrepreneurship (Wellness) with Honour at City Campus.	.000	H1 Accepted
H2-There is a positive relationship between the preparation preference of fast food selection among third-year students of Bachelor Entrepreneurship (Wellness) with Honour at City Campus.	.000	H2 Accepted
H3-There is a positive relationship between the price preference of fast food selection among third-year students of Bachelor Entrepreneurship (Wellness) with Honour at City Campus.	.000	H3 Accepted

Table 4 presents the results of the Pearson correlation analysis conducted to test the hypotheses. The p-value for the association between the nature of deliciousness in fast food and the dependent variable is .000, which is lower than the significance level of .001. Consequently, the hypothesis is deemed valid and accepted. Similarly, the p-value for the relationship between the nature of preparation in fast food and the dependent variable is .000, indicating statistical significance below the level of .001. Hence, the hypothesis is accepted.

Furthermore, the p-value for the connection between the quality of price and fast food is .000, demonstrating significance below .001. As a result, the hypothesis is accepted

## DISCUSSION AND RECOMMENDATION

The aim of this study is to investigate the relationship between 3 independent variables (delicious, preparation, price) preferences of fast-food selection among third-year students of bachelor entrepreneurship (wellness) with honour at the City Campus of UMK. The main findings of the study revealed that delicious, preparation, price exhibits a significant relationship with the fast-food selection in this research.

To improve future research in this study, several recommendations have been made. Firstly, combining qualitative and quantitative methodologies is suggested to enhance the investigation's effectiveness and precision. Secondly, when conducting online survey questionnaires, an official approach with a letter of approval should be utilized to ensure respondents' confidence and trust and prompt completion. It is also advised to narrow the scope of target respondents to eliminate imbalances and align the study with its title. Lastly, defining respondent characteristics can contribute to obtaining reliable results. These recommendations aim to improve the quality of future investigations and enhance the overall study.

## CONCLUSION

In conclusion, fast food offers a wide range of delicious options that are convenient and easy to prepare. The preparation of fast food is designed to be efficient and standardized. When it comes to pricing, fast food is generally considered to be affordable and budget friendly. Overall, fast food offers convenience and taste, but moderation and mindful eating are key to enjoying it without compromising well-being.

## REFERENCES

- Aiyun Xiao, Shaohua Yang, Qaisar Iqbal. (31 December 2018). Adm. Sci. 2019, 9(1), 4; <https://doi.org/10.3390/admsci9010004>
- Akter, M., Sadekin, M. N., & Patwary, A. K. (2020). An Empirical Study on Students' Satisfaction from Mawlana Bhashani Science & Technology University, Bangladesh. *Review of Economics and Development Studies*, 6(2), 363-379.
- Alicia Tuovila, (2020). What is Sampling? Retrieved May 28, 2020, from <https://www.investopedia.com/terms/s/sampling.asp>
- Alom, S., Patwary, A. K., & Khan, M. M. H. (2019). Factors affecting the turnover intention of Bangladeshi migrants in the United Arab Emirates: An empirical study on the hotel industry. *International Journal of Innovation, Creativity and Change*, 8(3), 344-360.
- applied to traditional and ethnic foods. In *Regulating Safety of Traditional and Ethnic Foods* (pp. 441–466). Elsevier.
- AR; S. G. M. A. (n.d.). How to create a lousy survey instrument? *Journal of graduate medical education*, from <https://pubmed.ncbi.nlm.nih.gov/28824750/>
- Askari Majabadi, H., Solhi, M., Montazeri, A., Shojaeizadeh, D., Nejat, S., Khalajabadi Farahani, F., & Djazayeri, A. (2016). Factors influencing fast-food consumption among adolescents in Tehran: A qualitative study. *Iranian Red Crescent Medical Journal*, 18(3), e23890. <https://doi.org/10.5812/ircmj.23890>

- Bhat, A. (2019, May 10). Data analysis in research: Why data, type of data, data analysis in qualitative and quantitative research. QuestionPro. <https://www.questionpro.com/blog/data-analysis>
- Cho, E., & Kim, S. (2015). Cronbach's Coefficient Alpha: Well-Known but Poorly Understood.
- D Roja L, S Nagamallesh C, C Navyashri (2022). Fast Food: Slow Poison. International Journal of Trend in Scientific Research and Development 6 (5), 214-218,2022.
- Editors of Encyclopaedia Britannica, (2018). Price/Economics. Retrieved Jun 01, 2018, from <https://www.britannica.com/topic/price-economics>
- Fengmin, Z., Baijun, W., Jiangtao, B., Li, L., & Patwary, A. K. (2022). Investigating revisit intention of medical tourists in China through nutritional knowledge, perceived medical quality, and trust in the physician: A recommendation on health tourism policy measures. *Frontiers in Public Health*, 10, 893497.
- Grant Stoddard, (2021). 17 Serious Side Effects of Eating Fast Food. Retrieved April 21, 2021, from <https://www.eatthis.com/what-happens-to-your-body-when-you-eat-fast-food/>
- Grassini, S., & Laumann, K. (2020, February 14). Questionnaire measures and physiological correlates of presence: A systematic review. *Frontiers*. <https://www.frontiersin.org/articles/10.3389/fpsyg.2020.00349/full>
- Hazbar, A. M. H., Alem Mohammed, A., & Karim, A. K. A. (2019). An Empirical Study of Factors Influencing hotel customers' online booking Intention. *مجلة العلوم التربوية و الدراسات الإنسانية*, (5), 1-17.
- Health Guides, (2022). Fast Foods Fact. Retrieved December 13, 2022, from <https://youngwomenshealth.org/guides/fast-food/>
- HM Moyeenudin, Mark Keith Faraday, John Williams,(2020). Health Implications on Consumption of Food at Fast Food Outlets in Chennai. *Insian Journal of Public Health Research & Development* 11 (2), 2020. [https://www.researchgate.net/publication/324890740\\_A\\_review\\_on\\_Fast\\_Foods\\_and\\_Family\\_in\\_generation\\_Y:\\_An\\_empirical\\_evidence\\_from\\_the\\_fast\\_food\\_industry\\_in\\_Malaysia](https://www.researchgate.net/publication/324890740_A_review_on_Fast_Foods_and_Family_in_generation_Y:_An_empirical_evidence_from_the_fast_food_industry_in_Malaysia). MDPI. <https://www.mdpi.com/2076-3387/9/1/4>
- Investopedia. <https://www.investopedia.com/terms/p/pearsoncoefficient.asp>
- Kaur, P., Stoltzfus, J., & Yellapu, V. (2018). Descriptive statistics. *Int J Acad Med*, 4, 60–63.
- Kenton, W. (2006, May 3). *What is the Pearson coefficient? Definition, benefits, and history*.
- Lange, J. A. (2021). Factors that Influence the Increasing of Obesity among UMK City. Obesity, Eating Habits, Physical Activity, Stress, University Malaysia, 488.
- Leroy R Thacker, II, PhD (2019). What is the Big Deal About Populations in Research.
- Li, L., Ragavan, N. A., Patwary, A. K., & Baijun, W. (2022). Measuring patients' satisfaction toward health tourism in Malaysia through hospital environment, nutritional advice, and perceived value: A study on Chinese exchange students. *Frontiers in public health*, 10, 893439.

- Li, L., Wu, B., & Patwary, A. K. (2022). How marine tourism promote financial development in sustainable economy: new evidences from South Asia and implications to future tourism students. *Environmental Science and Pollution Research*, 29, 1155-1172.
- Li, L., Wu, B., & Patwary, A. K. (2022). The psychosocial factors affecting chinese Outbound Exchange and mobility students' academic performance during COVID-19. *Frontiers in psychology*, 13, 872516.
- Merriam-Webster, (2022). Definition of Preparation. Retrieved December 13, 2022, from <https://www.merriam-webster.com/dictionary/preparation>
- Merriam-Webster, (2022). Definition of Delicious. Retrieved December 13, 2022, from <https://www.merriam-webster.com/dictionary/delicious>
- Nesrin Riad Mwafi, (2021). Prevalence and Factors related to obesity and fast food consumption among Mutah University students, Jordan. *JPMMA* 71 (1608),2021
- Nguyen Hoang Tien, (2019). Customization and Standardization of the Business Strategy of Foreign Enterprises in Vietnam: The McDonald' case and the fast-food sector. *International journal of Research in marketing management and sales* 1 (2), 44-50,2019.
- Noels, J. (2018, September 17). What are SPSS and its importance in research & data analysis?
- Olson, K . (2021, July). What are data? Qualitative health research. <https://www.ncbi.nlm.nih.gov/pmc/articles/PMC8438778/#:~:text=According%20to%20T%20Oxford%20Learner's,or%20to%20make%20decisions.%E2%80%9D>.
- Patwary, A. K., Roy, B., Hoque, R., & Khandakar, M. S. A. (2019). Process of developing a community based tourism and identifying its economic and social impacts: An Empirical study on Cox's Bazar, Bangladesh. *Pakistan Journal of Humanities and Social Sciences*, 7(1), 1-13.
- Se-Hak Chun, Ariunzaya Nyam-Ochir(2020). The effect of fast food restaurant attributes on Customer satisfaction, revisit intention and recommendation using DINESEV scale. *Sustainability* 12 (18), 7435,2020.
- Shona McCombes, (2022). Sampling Methods. Retrieved December 01, 2022, from, Simkus, J. (n.d.). *What is a pilot study?* Simplypsychology.org. Retrieved January 5, 2023, from <https://www.simplypsychology.org/pilot-studies.html>
- Sum Sochenda, (2021). Modeling of customer satisfaction and customer loyalty in fast food industry. *International Journal of Economics, Business and Accounting Research (IJEBAR)* 5 (4),2021.
- Sumethokula, P., Patwary, A. K., Srinuanpanc, B., Srinuanpand, C., Suwandee, P., Thammathikul, A., & Phanong, W. (2020). The potential of new tour repackaging for creative tourism among entrepreneurs in Nakhon Si Thammarat. *International Journal of Innovation, Creativity and Change*, 13(10), 1752-1771.

- Van der Meulen, B., Juanjuan, S., Carvajal, R., Kite, J., & Dias, T. C. (2016). Food safety regulations  
Welcome to UiTM Institutional Repository. Welcome to UiTM Institutional Repository – UiTM  
Institutional Repository. (n.d.). Retrieved January 2, 2023, from <https://ir.uitm.edu.my/>
- Wu, B., Liu, S., Wang, J., Tahir, S., & Patwary, A. K. (2021). Assessing the mechanism of energy efficiency and energy poverty alleviation based on environmental regulation policy measures. *Environmental Science and Pollution Research*, 28, 40858-40870.
- Wu, B., Zhai, B., Mu, H., Peng, X., Wang, C., & Patwary, A. K. (2021). Evaluating an economic application of renewable generated hydrogen: A way forward for green economic performance and policy measures. *Environmental Science and Pollution Research*, 1-15.
- Xiao, A., Yang, S., & Iqbal, Q. (2018, December 31). Factors affecting purchase intentions  
Yongping Zhong, Hee Cheol Moon (8 April 2020). *Foods* 2020, 9(4), 460;  
<https://doi.org/10.3390/foods9040460>

# UNHEALTHY LIFESTYLE FACTORS AMONG WELLNESS STUDENTS AT UMK CITY CAMPUS

Balqis Nur Athira binti Mohd Zulmizan, Rabiatuladawiyah binti Zawadod, Nurul Kiasatina binti Kaparom@Harun, Fatin Nadirah binti Lan & \*Dr.Suchi binti Hassan

*Faculty of Hospitality, Tourism and Wellness, Universiti Malaysia Kelantan*

*Corresponding email: [suchi.h@umk.edu.my](mailto:suchi.h@umk.edu.my)*

---

## ABSTRACT

Being overweight has serious adverse effects on health, linked to hypertension, coronary heart disease, stroke, type 2 diabetes, and some cancers of the breast, colon, prostate, endometrium, and gallbladder. Being overweight accounts for 5% of all deaths worldwide. Being overweight can also lead to serious physical behaviour, social, psychological, and economic consequences. The main objective of this research is to examine the relationship between unhealthy lifestyle factors among students at University of Malaysia Kelantan. There are three research objectives. To examine the relationship between hereditary disease and unhealthy lifestyles. Next is to examine the relationship between psychology and unhealthy lifestyles and the last one to examine the relationship between peer influence and unhealthy lifestyles. The conceptual framework contains three independent variables: hereditary disease, psychology, and peer influence. Moreover, one dependent variable is an unhealthy lifestyle. According to the findings of the literature analysis, the researcher has created the frame shown below related to the characteristics of unhealthy lifestyles among UMK students.

**Keywords:** Hereditary disease, Psychological, Peer influence, Unhealthy lifestyle

---

## **INTRODUCTION**

The A healthy body is essential for a prosperous existence, and the Malaysian educational system aims to create individuals who are intellectually, physically, psychologically, emotionally, and spiritually balanced. The Malaysian Ministry of Education has developed a unique physical education and health education curriculum to educate students on physical fitness, sportsmanship, sports and recreation skills, personal and family health, healthy living, and environmental cleanliness and safety. The curriculum focuses on macronutrients, micronutrients, and nutrition, as well as illnesses related to eating patterns, such as obesity, coronary heart disease, hypertension, diabetes mellitus, and peptic ulcer.

The government has spent significant money on paying rising medical bills, and advertisements have focused on health issues. A healthy community can be aided by maintaining good nutrition and engaging in physical exercise for at least 30 minutes three times a week. Engaging in physical activity and eating a balanced diet are the primary goals of a healthy lifestyle.

People are increasingly realizing the importance of health and prioritizing it as something to be proud of. Food plays a crucial role in human life, providing daily energy and nutrients for the body's metabolic processes. A balanced diet is essential for optimal health and growth, and poor eating habits, such as high cholesterol, fat, oil, salt, and sugar, can lead to various health issues and diseases.

### ***Research Objective***

1. To examine the relationship between hereditary disease and unhealthy lifestyles.
2. To examine the relationship between psychological and unhealthy lifestyles.
3. To examine the relationship between peer influence and unhealthy lifestyles

### ***Research Questions***

1. What is the relationship between hereditary disease and unhealthy lifestyle?
2. What is the relationship between psychological and unhealthy lifestyle?
3. What is the relationship between peer influence and unhealthy lifestyle?

## **SIGNIFICANCE OF THE STUDY**



This study will be helpful to future researchers covering similar events and topic areas. As a result, future researchers can obtain additional knowledge and data for their future studies. Wellness students, they will increase the health industry's understanding of unhealthy lifestyle factors that can be used to improve health. By doing so, all Wellness students will better understand the unhealthy lifestyle factors associated with being overweight. This research will affect several factors from an unhealthy lifestyle. This research will be helpful to anyone interested in examining the concept of health in nutrition.

## **LITERATURE REVIEW**

### **Hereditary Disease**

Hereditary illness is the process of encoding traits in genes and passing them down from parents to offspring. It is a unique gene combination created by combining some of the mother's genes with the father's DNA. Family history is a crucial factor in differential diagnosis, as it reveals a person's future risk of developing conditions like heart disease, diabetes, or cancer. Each chromosome contains many genes, with only 29% of the human genome being composed of genes. Hereditary factors can cause or impact several diseases, with the three main categories being single-gene, chromosomal, and multifactorial. Modern genetic testing can identify hereditary conditions through chromosomal, biochemical, or DNA-based technology. It is essential to retrieve multiple family members' DNA for testing to be helpful for a disorder.

Research Hypothesis

## **Psychological**

Physiological, psychological, social, and genetic factors influence food intake, food preference, and meal time. Cognitive factors, such as self-regulation, motivation, and self-efficacy, can also impact eating behaviour. Stress can lead to increased appetites, and students with mental illnesses may struggle with managing eating habits, exercise, and maintaining a balanced body weight. The mind plays a crucial role in determining the need for exercise and the importance of eating well. People may become "restrained eaters," making decisions based on factors like cost, brand, and accessibility. Self-regulation, or the ability to control and self-regulate one's actions, is another area of study for psychologists. When self-regulation fails, people may forget about their diet, leading to "perverse logic." Both inner and extrinsic motivation are necessary to lose weight.

## **Peer Influence**

Peer influence is the decision to engage in activities or behaviours based on acceptance and value from friends. It can be beneficial, such as motivating individuals to work harder, serve as positive role models, and expose them to positive influences. However, it can also be harmful, such as encouraging unhealthy behaviours or social behaviours. Peer influence is crucial in promoting a healthy lifestyle and offering moral and emotional support. People with a positive outlook on health can demonstrate the value of maintaining a healthy lifestyle. However, if peers desire to harm health, they can do so, as seen with disregarding hygienic rituals. A healthy lifestyle is closely tied to peer influence, as it significantly impacts a person's health and determines their course.

## **Unhealthy Lifestyle**

Lifestyle is a way of living influenced by geography, economics, politics, culture, and religious texts. It affects 60% of variables impacting individual health and quality of life. Millions of people live unhealthy lives, leading to diseases, disability, and death. Lifestyle factors include malnutrition, improper diet, smoking, alcohol, drug misuse, stress, and new IT technologies. Lifestyle has a significant impact on human physical and mental health, with consanguinity and drug abuse being major risks. Reforming unhealthy lifestyles is crucial for minimizing genetic diseases and improving overall health.

## **Research Hypotheses**

H1: There is a significant relationship between hereditary disease and unhealthy lifestyle among Wellness students at UMK City Campus.

H2: There is a significant relationship between psychological with unhealthy lifestyles among Wellness students at UMK City Campus.

H3: There is a significant relationship between peer influence and unhealthy lifestyle among Wellness students at UMK City Campus.

## **Research Framework**

Framework showing the researcher how the study concept and variables can be achieved together. The independent variable and the dependent variable are two variables in the framework. The conceptual framework contains three independent variables: hereditary disease, psychology, and peer influence. Moreover, one dependent variable is an unhealthy lifestyle. According to the findings of the literature analysis, the researcher has created the frame shown below related to the characteristics of unhealthy lifestyles among UMK students. Fransen et al. (2016) stated that many studies have linked unhealthy diets to several aspects, such as socio-demographic and lifestyle factors. According to Deasy et al., (2014). Students in higher education should be aware of this behaviour because it may indicate psychological discomfort, cause by self-inflicted actions.

## **METHODOLOGY**

### **Research Design**

This study's methodology employs quantitative methodologies. Students of Wellness at University Malaysia Kelantan were studied for their unhealthy lifestyles using a quantitative research methodology. Quantity is prioritised in the quantitative approach. This is due to researchers using numerical or statistical data. The quantitative method is organised, has a distinct scan and different emphasises outcomes. A qualitative approach is used to obtain data, derive meaning from the study, and gain knowledge. Data collection procedures include, for instance, identifying individuals, making records, sampling, recording data, addressing problems in the field, and storing data (Cresswell, 1998).

## **Data Collection**

The researcher collects data from primary sources using various research methods of data collecting that can be used to continue the study. At the UMK City Campus, data was collected based on information concerning unhealthy lifestyles among Wellness students who were overweight. For students to better understand health, data is collected through a survey.

The tool used to collect the data required for the questionnaire is a google form that is distributed to selected respondents online through a google form link who voluntarily answer the questionnaire used to obtain data about unhealthy lifestyle factors among Wellness students against overweight at UMK City Campus. This questionnaire can identify the relationship between hereditary diseases, psychological, and peer influence.

Researchers in this study will collect primary data during the distribution of questionnaires to respondents, and the data collection results will be obtained. Secondary data was also used in this inquiry, referred by the researcher in the journal publication of previous research studies and used for this study.

## **Sampling**

In this study, simple random sampling, a type of probability sampling method, will be used. It is a type of sampling to obtain information about a population such as a person, institution, place, or phenomenon. The researcher chose this sampling strategy because the results obtained from the sample are the same as those obtained from measuring the entire population (Shadish et al., 2002). Simple random sampling gives each unit in the population an equal probability of being selected. This sampling is the easiest and easiest to select the respondents of the study, and the cost is not expensive. In other words, this sampling strategy is not determined by the sampling procedure because anyone can be used as a study sample. By using this sampling method, researchers can get data results immediately.

## **Data Analysis**

The process of collecting, modelling, and analysing data to obtain insights that can be used to make decisions is known as data analysis. It is also a technique used by researchers to dissect and interpret data in order to gain insights, make recommendations, and aid decision-making. The researcher's information was processed and used in the study. All of the information was gathered from various sources. The Statistical Package for Social Science (SPSS) will be used to analyse the data collected by the researcher in this study. As a result, researchers from various fields use IBM SPSS Version 25 software for quantitative analysis of complex data. This statistical tool can process statistical data and provide answers for this study.

## FINDINGS

### Demographic Analysis

#### 4.4.1 Gender of Respondents

##### Gender

		Frequency	Percent	Valid Percent	Cumulative Percent
Valid	Male	62	25.6	25.6	25.6
	Female	180	74.4	74.4	100.0
	Total	242	100.0	100.0	

Table 4.8: Number of Respondents by Gender

#### 4.4.2 Age of Respondents

##### Age

		Frequency	Percent	Valid Percent	Cumulative Percent
Valid	18-21 years old	24	9.9	9.9	9.9
	21-24 years old	191	78.9	78.9	88.8
	24-28 years old	24	9.9	9.9	98.8
	Other	3	1.2	1.2	100.0
	Total	242	100.0	100.0	

Table 4.9: Number of Respondents by Age

#### 4.4.3 Ethnicity of Respondents

##### Ethnicity

		Frequency	Percent	Valid Percent	Cumulative Percent
Valid	Malay	196	81.0	81.0	81.0
	chinese	19	7.9	7.9	88.8
	Indian	16	6.6	6.6	95.5
	Others	11	4.5	4.5	100.0
	Total	242	100.0	100.0	

Table 4.10: Number of Respondents by Ethnicity

#### 4.4.4 Marital of Respondents

##### Marital

		Frequency	Percent	Valid Percent	Cumulative Percent
Valid	Single	229	94.6	94.6	94.6
	Married	13	5.4	5.4	100.0
	Total	242	100.0	100.0	

Table 4.11: Number of Respondents by Marital

#### 4.4.5 Years of study of Respondents

### Years of study

		Frequency	Percent	Valid Percent	Cumulative Percent
Valid	years 1	20	8.3	8.3	8.3
	years 2	37	15.3	15.3	23.6
	years 3	160	66.1	66.1	89.7
	years 4	25	10.3	10.3	100.0
	Total	242	100.0	100.0	

**Table 4.12: Number of Respondents by Years of Study**

### Descriptive Analysis

#### Descriptive Statistics

Variables	Mean (M)	Std. Deviation (SD)	N
Dependent Variable (DV)	4.2410	.55928	242
Hereditary Disease (HD)	3.9284	.72904	242
Psychological (P)	4.1260	.75508	242
Peer Influence (PI)	4.1260	.75508	242

Sources: SSPS

**Reliability Analysis**

<b>Dependent Variable</b>	<b>Cronbach' Alpha</b>	<b>Number of Items</b>
	<b>0.664</b>	<b>3</b>
<b>Demographic Data</b>		
<b>Independent Variable</b>		
<b>Hereditary disease</b>	<b>0.764</b>	<b>7</b>
<b>Psychological</b>	<b>0.713</b>	<b>2</b>
<b>Peer influence</b>	<b>0.713</b>	<b>2</b>

Sources: SPSS

**Table 4.7: Reliability Statistic**

**Pearson Correlation Analysis**

	<b>Hereditary Disease</b>	<b>Psychological</b>	<b>Peer Influence</b>	<b>Unhealthy Lifestyle</b>
<b>Hereditary Disease</b>	1	.377**	.377**	.339**
<b>Psychological</b>	.377**	1	1.000**	.450**
<b>Peer Influence</b>	.377**	1.000**	1	.450**
<b>Unhealthy Lifestyle</b>	.339**	.450**	.450**	1

\*\* . Correlation is significant at the 0.01 level (2-tailed)

Sources: SPSS



## **DISCUSSION AND RECOMMENDATION**

In other words, there are many causes and reasons that contribute to unhealthy lifestyles among Wellness students at UMK City Campus. However, based on the research we have done, we only use hypotheses which are hereditary diseases, psychology and peer influence. Based on random and non-random discussions, all of these hypotheses are closely related and have a profound effect on the unhealthy lifestyle of wellness students at UMK city campus. However, due to the fact that these wellness students are in UMK city campus rather than on campus, the influence of peers should be more of a cause for unhealthy lifestyles for these students. But this matter needs to be taken seriously, because they are wellness students who are indeed healthy students and they should show a healthy lifestyle as wellness students. Therefore, unhealthy lifestyles need to be curbed to ensure that all campus students regardless of students from all faculties lead a healthy lifestyle.

## **CONCLUSION**

In conclusion, overall, the findings of the study we found from the research we conducted, namely unhealthy lifestyle factors among wellness students at UMK city campus, we found that all the hypotheses we used have a close relationship with our topic. All of our respondents also agreed with the variables we released in this research as a result of the findings we got from the survey conducted. It can be seen clearly in our table 4, which is in the findings which provide a summary of the entire question from questionnaire.

## **REFERENCES**

Aseervatham, G., Sivasudha, T., Jeyadevi, R., & Arul Ananth, D. (2013). Environmental factors and unhealthy lifestyle influence oxidative stress in humans—an overview.

Environmental Science and Pollution Research, 20(7), 4356-4369.

Advanced Learner's Dictionary at OxfordLearnersDictionaries.com. (n.d.).

<https://www.oxfordlearnersdictionaries.com/definition/english/unhealthy>

Allen, M. (2017). The SAGE Encyclopedia of Communication Research Methods. SAGE Publications.

<https://methods.sagepub.com/reference/the-sage-encyclopedia-of-communication-research-methods>

- Barker, D. J. P. (2007). The origins of the developmental origin theory. *Journal of Internal Medicine*, 261(5), 412–417. <https://doi.org/10.1111/j.1365-2796.2007.01809.x>
- Cambridge Dictionary. (2022). lifestyle definition: 1. someone’s way of living; the things that a person or a particular group of people usually do: 2. . .. Learn more. <https://dictionary.cambridge.org/dictionary/english/lifestyle>
- ROLL, J., NEUMARKSZTAINER, D., STORY, M., & IRELAND, M. (2002). Prevalence and risk and protective factors related to disordered eating behaviors among adolescents: relationship to gender and ethnicity. *Journal of Adolescent Health*, 31(2), 166–175. [https://doi.org/10.1016/s1054-139x\(02\)00368-3](https://doi.org/10.1016/s1054-139x(02)00368-3)
- Claassen, L., Henneman, L., Kindt, I., Marteau, T. M., & Timmermans, D. R. M. (2010). Perceived Risk and Representations of Cardiovascular Disease and Preventive Behaviour in People Diagnosed with Familial Hypercholesterolemia. *Journal of Health Psychology*, 15(1), 33–43. <https://doi.org/10.1177/1359105309345170>
- Current Links for doi: 10.4135/9781483381411. (2017). Crossref.org. <http://mr.crossref.org/iPage?doi=10.4135%2F9781483381411>
- Chadwick, A. (Ed.) (2017). (Vols. 1–4). SAGE Publications, Inc, <https://dx.doi.org/10.4135/9781483381411>
- Default - Stanford Medicine Children’s Health. (n.d.). <https://www.stanfordchildrens.org/en/topic/default?id=the-growing-child-adolescent-13to-18-years-90-P02175>
- Definition of lifestyle. (n.d.). In [www.dictionary.com](http://www.dictionary.com). <https://www.dictionary.com/browse/lifestyle>
- Definition of psychological. (n.d.). [www.dictionary.com](http://www.dictionary.com). <https://www.dictionary.com/browse/psychological>
- Dayspring. (2018, October 14). Impact of Unhealthy lifestyle on Human Health - The Dayspring | Youth Centric Newspaper of Pakistan. The Dayspring | Youth Centric Newspaper of Pakistan. <https://www.thedayspring.com.pk/impact-of-unhealthy-lifestyle-on-human-health/>

- Factor. (2022b). In The Merriam-Webster.com Dictionary.  
<https://www.merriamwebster.com/dictionary/factors>
- Farhud, D. D. (2015, November 1). Impact of Lifestyle on Health. PubMed Central (PMC).  
<https://www.ncbi.nlm.nih.gov/pmc/articles/PMC4703222/>
- Franklin Kibuacha. (2021, April 7). How to Determine Sample Size for a Research Study - GeoPoll.  
 GeoPoll. <https://www.geopoll.com/blog/sample-size-research/>
- Furihata, R., Konno, C., Suzuki, M., Takahashi, S., Kaneita, Y., Ohida, T., & Uchiyama, M. (2018).  
 Unhealthy lifestyle factors and depressive symptoms: A Japanese general adult population survey.  
 Journal of affective disorders, 234, 156-161.
- Johnson, J. (2020, December 11). What causes food cravings?  
<https://www.medicalnewstoday.com/articles/318441>
- Just a moment. . . (n.d.). <https://www.collinsdictionary.com/dictionary/english/factor>
- Just a moment. . . (n.d.-b). <https://www.collinsdictionary.com/dictionary/english/teenage>
- Just a moment. . . (n.d.-c). <https://journals.sagepub.com/doi/full/10.1177/0963721420904958>
- Kaur, B. (2021, October 27). Healthy vs. Unhealthy Lifestyle – Blog by Datt Mediproducts.  
<https://dattmedi.com/blog/healthy-vs-unhealthy-lifestyle/>
- Peer influence - Definition and more | THE-DEFINITION.COM. (n.d.). the-definition.com. <https://the-definition.com/term/peer-influence>
- Mohamad, M. S., Man, S., & Ramli, M. A. (2015). Keselamatan Makanan Menurut  
 Perspektif Islam: Kajian Terhadap Pengambilan Makanan Berisiko. Jurnal Fiqh, 12(1), 1–  
<https://doi.org/10.22452/fiqh.vol12no1.1>
- McCombes, S. (2019, September 19). Sampling Methods | Types, Techniques & Examples. Scribbr.  
<https://www.scribbr.com/methodology/sampling-methods/>
- Unhealthy adjective - Definition, pictures, pronunciation, and usage notes | Oxford
- Unhealthy lifestyle. (n.d.). <http://www.speakforhealthyindia.com/unhealthy-lifestyle/>

Unhealthy food. (n.d.) McGraw-Hill Concise Dictionary of Modern Medicine. (2002).

Retrieved November 2, 2022, from

<https://medicaldictionary.thefreedictionary.com/unhealthy+food>

Why Do We Love Unhealthy Foods So Much? Science ABC. (2022, March 25).

<https://www.scienceabc.com/humans/why-do-we-love-unhealthy-foods-so-much.html>

Teja, S. (2016). Kaedah penyelidikan (persampelan). Slideshare.net.

<https://www.slideshare.net/tejasyahremie/kaedah-penyelidikan-persampelan>

# STUDENT'S MOTIVATION AFTER RETURNING TO UNIVERSITY MALAYSIA KELANTAN CITY CAMPUS

*NURUL HUSNA FATIMAH BINTI MD NOOR, SITI NUR IZZAHTY BINTI MUSARI,  
NURHASYA HUSNA BINTI MOHD. ISMAIL, NURAIISHA FAZRIN BINTI MOHAMAD  
TERIDI\*DR SUCHI BINTI HASSAN\**

*Faculty of Hospitality, Tourism, and Wellness, Universiti Malaysia Kelantan  
Corresponding email: [suchi.h@umk.edu.my](mailto:suchi.h@umk.edu.my)*

---

## ABSTRACT

Motivation is dropping due to Malaysian Movement Control Order (MCO) due to COVID-19. This situation also affects students' motivation because they have to change their way of learning from face-to-face to online learning. Therefore, this study looks at students' motivation after returning to the Universiti Malaysia Kelantan City Campus. This study tries to achieve three research objectives and three research questions. For that purpose, 327 students from the hospitality, tourism, and wellness departments at the Universiti Malaysia Kelantan took part in this survey. The research was done descriptively, utilizing an online questionnaire to collect respondents' replies. The study's results reveal that student motivation after returning to university is modest, although respondents feel that they effectively overcame problems, collaboration, and appreciation throughout the learning session. According to the results, the campus is highly significant as a center and site of learning to promote student motivation. Furthermore, intrinsic motivators for students, such as challenge, collaboration, and student recognition, may be discovered among students at Universiti Malaysia Kelantan. In conclusion, we have learned through this coursework that student motivation aspects are very significant and beneficial to students after they return to university.

**Keywords:** Intrinsic motivation, challenge, collaboration, student recognition

---

## INTRODUCTION

Motivation is the fuel that propels individuals to achieve their goals and objectives. Humans would remain inert without this fuel, resulting in a regular and unproductive existence. People may be motivated by the factors that come from inside and those that come from outside. The source of an individual's intrinsic drive is found inside themselves, whereas extrinsic motivation comes from the environment around them. The concepts of money, rewards, deadlines, and punishment are all examples of extrinsic motivation. In contrast, the images of pleasure, purpose, pride, interest, knowledge, and self-worth are all examples of intrinsic motivation (Gayane Tovmasyan, 2020). The word motivation originates, which translates to move. Accordingly, the term motivation is being used to refer to a strong desire that manifests itself in a person and has the potential to influence the behavior that will be created. This desire will motivate action to work toward achieving the objective that has been set. Therefore, this study proposes three research objectives to explain the statement:

1. To investigate the relationship between challenge and motivation after returning to the University Malaysia Kelantan City Campus.
2. To investigate the relationship between cooperation and motivation after returning to the University Malaysia Kelantan City Campus.
3. To investigate the relationship between recognition and motivation after returning to the University Malaysia Kelantan City Campus.

## **SIGNIFICANCE OF THE STUDY**

The study is intended to help other researchers learn more about the causes of the problem of influence and mental health for student motivation. When we return to campus from this survey, we will know what action is needed to solve the problem and what development is needed to ensure success for each student. Furthermore, this survey will assist not only the university but also the government in taking action to stabilize and improve learning quality. Finally, this research will develop various methods to ensure that students always receive high-quality learning content while remaining free of external pressure. This will result in effective, relaxed, beneficial, and successful learning for the next generation.

## **LITERATURE REVIEW**

### **CHALLENGE**

First, there are many factors that affect student motivation after returning to campus, including the challenge factor (Fitriana Harintama's (2020)). The challenge factor is one of the factors that affect student motivation after returning to campus (Fitriana Harintama's (2020)). It is also considered as a factor component internal factors that affect a student's ability to study on campus. This is also reinforced by the choice model that will be influenced by the individual that is the student and the socioeconomic environment as stated in the same publication.

Motivational challenges are included in the model as a study contained in it. The challenge factor is based on the individual's experience with certain situations, which can lead to different types of learning, and the social learning environment is based on the student's attitude during the lesson. In general, motivational challenge factors such as emotions, mood, and attitude towards learning have a great impact on students' ability after returning to campus. A condition in which one's ability is tested by being presented with something that, to complete correctly, requires great mental and physical effort on their part. Students who are challenging to work with engage in behaviors such as talking too much, not being able to sit still, being apathetic or distracted, disruptive or disrespectful.

### **COOPERATION**

According David Hortigüela Alcalá1, Alejandra Hernando Garijo, ngel Pérez-Pueyo, and Javier Fernández-Ro (2019) define cooperative learning as "a major step beyond just learning side by side other to learn with, by, and for each other." This might imply that collective learning is preferable to individual learning. We may deduce from this that to cooperate, students actively establish small, varied groups based on criteria such as gender, color, ability, and socioeconomic level. Many academics agree on five fundamental components of cooperative learning. The first is the connection for the better, interdependence. It refers to how members of an organization rely on one another to achieve its goal. This is illustrated by the fact that this pattern may teach someone to accept and get along with others. Then there's the ensuing promotional engagement. It symbolizes the third individual responsibility job, face-to-face contact with current group members. It suggests that each group member is in charge of a specific work. Everyone is responsible for taking responsibility for this. The fourth is interpersonal and small-group skills. They include recognizing other people's efforts, offering and accepting feedback, and actively listening. It is fantastic that some individuals appreciate providing constructive criticism and comments since it makes it easier to discover and solve issues. And group processing is the fifth and final stage in groups.

The term "cooperative learning" refers to a kind of education in which students are divided into smaller groups and tasked with completing a single project collaboratively. Students can work together on various assignments, from straightforward mathematical exercises to substantial projects such as devising environmental solutions at the national level; hence, the parameters are typically left up to interpretation. There will be moments when the entire class will be held accountable for the work, and there will also be occasions when each student will be held individually responsible for their contribution.

## **RECOGNITION**

According to Agota Kun and Peter Gadanecz (2019), learning is intrinsically motivated since incentives are crucial, but many students also put great value on the credentials they will obtain after graduation. Further analysis revealed that teachers emphasized the importance of feedback from students, parents, coworkers, and leaders, emphasizing the need to get good feedback from individuals close to them or superiors to enhance their confidence and enthusiasm for better things. The following subcategory focuses on moral praise and esteem for the educator's efforts. When discussing the preceding category, students, employees, parents, and leaders receive a broad degree of acknowledgment. This is because success via their efforts improves their worth. Moral appreciation and value recognition have an unmistakable influence on commitment and performance.

## **STUDENT MOTIVATION AFTER RETURNING TO CAMPUS**

Students may be encouraged to study through motivation, a key psychological concept in education (Faridah et al., 2020). It is essential to have some cognitive motivation (the desire to take conscious action) when engaging in online learning. When a student completes a task, it is not out of fear, to stand out, or for a reward; rather, it is to learn and grow, broaden one's perspectives, and advance in one's personal development (Samsudeen and Mohamed, 2019). In an online learning environment, the ability to maintain student motivation relies on the student. It may be difficult for students who lack study motivation to focus on what is being taught (Jammu, Kim, and Lee, 2008). Studies in both the medical and non-medical fields have shown that students are typically happy with the suggested e-learning approaches. Students express much higher levels of satisfaction with e-learning compared to more conventional educational modalities; this is also true of their assessments of the relative ease of access, navigation, engagement, and interface usage (De Leeuw et al., 2019).

## **RESEARCH HYPOTHESIS**

The research hypothesis is based on study factors such as challenge, cooperation, and recognition in education among university students. Based on the study hypothesis, the following were developed and were to be tested:

- H1:** There is a relationship between challenges and motivation after returning to the University Malaysia Kelantan City Campus.
- H2:** There is a relationship between cooperation and motivation after returning to the University Malaysia Kelantan City Campus.
- H3:** There is a relationship between recognition and motivation after returning to the University Malaysia Kelantan City Campus.

## RESEARCH FRAMEWORK

Based on the previous literature review, the researchers have proposed a framework to study the students' motivation after returning to the University Malaysia Kelantan City Campus. Hence, as seen below, the structure.

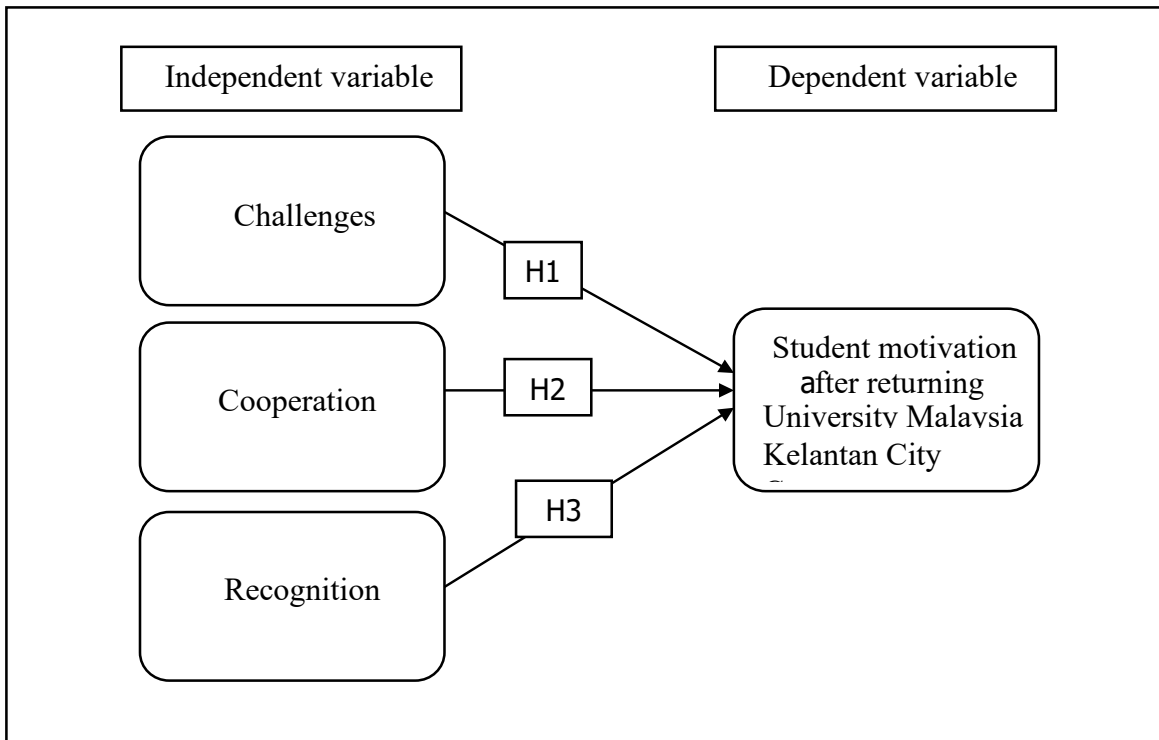

## METHODOLOGY

This chapter discusses analytical approaches. The method of analysis employed to finish the case study is described in this chapter. The study methodology, target population, sample size, sampling procedure, data collection, research instrument, data analysis, and chapter description for this report have all been completed. Because research is a form of intellectual activity, it must be used in a business setting (Kothari,2004). Finally, the methodology of this investigation has been described. This part illustrates the whole process of carrying out this study session. When doing industrial research, analysis is a form of analytical practice that must be employed (Kothari,2004). The study procedure, data gathering method, sample strategy, and work produced are all part of the analysis approach.

## RESEARCH DESIGN

Quantitative methods are theoretically validated, numerically measured, and statistically analyzed, focusing on objectivity and reproducibility. Smith and colleagues (1979). To draw conclusions or test hypotheses, quantitative analysis design relies on numerical evidence. Inequality for both will influence the decision of characters who wish to be completed. Tests, questionnaires, probability sampling, and document reviews are quantitative data sources. A quantitative research approach was applied in this investigation. To test the relationship between collected data, quantitative observation based on statistical data is used. Quantitative research designs are used when statistical conclusions for a set of actionable insights are significant. The main distinction between the four types is the amount of design control the researcher has over the variable in the experiment (Fatima, 2019). This study will employ quantitative methods. This is because the quantitative research strategy assumes continuous and distinct numerical data.



Quantitative is also referred to as numerical form. The primary purpose of this study is to investigate the relationship between students' issues, collaboration, recognition, and motivation upon their return to the University Malaysia Kelantan City Campus. Second, more significant sample size analyses are feasible. Because the research included students from the Faculty of Hospitality, Tourism, and Wellness, the findings apply to the broader public. Third, each responder may be given a regular and formal questionnaire.

## **DATA COLLECTION**

This strategy may be used with either primary or secondary data. Preliminary data, also known as raw data, is information that is gathered straight from the source, whereas secondary data is information that has previously been collected, organized, and analyzed by another researcher, according to Jovancic and Nemanja (2019). Gathering information for the study from dependable sources, such as students, the organization, the public, or other research groups, is a component of primary data analysis studies. Secondary data research is the process of gathering information from published sources that is pertinent to the present research topic. The important information learned from the survey. 335 students from the Department of Hospitality, tourism, and Wellness at the University of Malaysia Kelantan responded to the survey. The information from their replies was collected by the researchers over the course of about two weeks. In Section A, the respondent is required to provide demographic data, including their gender, age, ethnicity, year of study, and program. The independent variable problems are in Parts B, C, and D, while the dependent variable problems are in Part E. While Sections B, C, D, and E utilize the Likert Scale, Section A's questionnaire architecture employs a nominal and interval scale.

## **SAMPLING**

The researchers employed non-probability sampling and the researcher uses convenience sampling approaches for the investigation. Questionnaire forms will be distributed to respondents from the hospitality, tourism, and wellness department at the University of Malaysia Kelantan to ask the respondents about their motivation after returning to university.

## **DATA ANALYSIS**

Data analysis is the methodical process of collecting, gathering, and analyzing data to explain and prove anything. Additionally, data analysis seeks to extract pertinent information from data so that conclusions may be drawn based on that knowledge. Research methods use both primary and secondary data. The Statistical Package for the Social Sciences (SPSS) was used to analyze information that was obtained from the original researcher as preliminary data for this investigation. A collection of interconnected software tools is called SPSS. Quantitative research, according to Ahmad et al. (2019), is a study that uses theoretical physics approaches to produce numerical data and facts via the gathering of questionnaire data.

## FINDINGS

### Result of Frequency Analysis

Table 1 shows the result of frequency analysis of respondents.

Table 6: Frequency Analysis

Characteristics	Frequency	Percentage (%)
<b>Age</b>		
19-21 years	64	19.6
22-24 years	236	72.2
25-26 years	26	8.0
<b>Gender</b>		
Male	118	36.1
Female	209	63.9
<b>Education Level</b>		
Degree	327	100
<b>Ethnicity</b>		
Malay	242	74
Chinese	36	11
Indian	25	7.6
Others	24	7.3
<b>Year of study</b>		
Year 1	28	8.6
Year 2	67	20.5
Year 3	200	61.2
Year 4	32	9.8
<b>Program</b>		
SAP	84	25.7
SAH	104	31.8
SAS	139	42.5

Table 1 displays the findings of the respondents' frequency analysis. The study focuses on FHPK students at Universiti Malaysia Kelantan's City Campus. Most respondents, 236 in total (72.2%), were between the ages of 22 and 24, while 64 respondents (19.6%) were between the ages of 19 and 21. Next, there are 209 respondents who are female (63.9% of the total), compared to 118 respondents who are male (36.1%). 327 individuals, or 100%, of the sample, hold a degree in education. Additionally, the bulk of respondents—242 respondents, or 74% of the total—are Malay, followed by Indians with 25 respondents (7.6%), Chinese with 36 respondents (11%), and others with 24 respondents (7.3%). Additionally, year 3 had the highest percentage of responses (200 respondents, or 61.2%), followed by year 2 (67 respondents, or 20.5%), year 4 (32 respondents, or 9.8%), and year 1 (28 respondents, or 8.6%). Finally, program SAH receives the most responses, accounting for 104 respondents (31.8%), followed by program SAS with 139 respondents (42.5%) and program SAP with 84 respondents (25.7%).

## Result of Descriptive Analysis

Table 2 shows the result of descriptive analysis of variable.

Table 7: Descriptive Analysis

Variable		Means	Standard
Items		score	deviation
<b>challenges</b>	I often wish I was doing something else in class	3.28	1.392
	During class, I often miss important things because I'm thinking about other things	2.60	1.254
	It is important for me to learn what is taught in class.	3.91	1.281
	When the work is difficult, I either give up or learn only the easy part	2.59	1.217
	I always try to understand what the lecturer is saying, even if it doesn't make sense.	3.15	1.284
	I want to succeed in my studies because it is important to show my ability to my family, friends, employer or other people.	4.41	0.948
	I often feel so lazy or bored in class that I have trouble completing my assignment.	2.63	1.318
	I use my class time well	4.10	0.850
	I ask the lecturer for help when I need it.	4.13	0.978
	I often attend class.	4.37	0.978
<b>Cooperation</b>	I like working together in a group to complete a task	4.03	1.019
	I like to ask other friends for opinions	4.13	0.949
	I can easily focus on studying in groups	3.79	1.119
	I like to ask friends about lessons that are not understood	4.17	0.912
	I can discuss it with friends about the lesson	4.13	0.939
	I like to share ideas with friends	4.07	0.927
	I like to be the leader working in groups.	3.44	1.249
	I communicate easily when working in groups.	3.94	0.938
	I like to chat rather than discuss work	3.25	1.296
	I like to keep quiet when studying in groups.	2.51	1.294
<b>Recognition</b>	Students will get a certificate when they attend a program.	4.23	0.965
	Students will get a certificate when they volunteer in a program	4.13	0.992
	I like being appointed as a student leader	3.31	1.261
	I study solely to get the dean's certificate	3.46	1.335
	Students will get marks for full attendance	4.04	1.069
	I like to be a role model by dressing well in class.	3.69	1.092
	Students will be fined if they break the rules	4.21	0.905
	Students will get a leave letter when sick.	4.22	0.962
	I am more enthusiastic when the lecturer praises my work	4.34	0.898
	The university will reward students when they get excellent results.	4.39	0.930
<b>Student motivation</b>	I concentrate on my assignment	4.04	1.021
	I feel proud of my university	4.12	0.951
	I am a responsible student	3.77	1.117
	I am responsible for achieving my goals	4.16	0.911
	I am good at staying focused on my goals	4.14	0.940
	I respect other points of view, even if I do not agree	4.08	0.931
	I work well in groups or teams	3.43	1.248
	It is easy for me to convey my thoughts and ideas	3.95	0.939
	I finish whenever I start something	3.26	1.297
	I always can come up with new ideas	2.50	1.292

The outcome of the descriptive analysis of the variable is shown in Table 2. The item of student motivation (I am accountable for attaining my objectives) had the highest mean score for the dependent variable, student motivation (M=4.16, SD=0.911). The student motivation question, which asks, "I always have new ideas," gets the lowest mean score (M=2.50.66, SD=1.292). The challenge factors item, "I want to succeed in my studies because it's important to prove my ability to my family, friends, employer, or other people," has the highest mean score (M=4.41, SD=0.948), whereas the challenge factors item, "When the work is difficult, I either give up or learn only the easy part," has the lowest mean score (M=2.59, SD=1.217). Aside from that, the cooperation factors item (I like to ask friends about lessons that are not understood.) has the highest mean score (M=4.17, SD=0.912) and the cooperation factors item (I like to keep quiet when studying in groups.) has the lowest mean score (M=2.51, SD=1.294) for the second independent variable. The item of recognition factors (The university will reward students when they get excellent results) has the highest mean score (M=4.39, SD=0.930) and the item of recognition factors (I like being appointed as a student leader) has the lowest mean score (M=3.31, SD=1.261) for the third independent variable, recognition factors.

### Result of Reliability Analysis

Table 3 shows the result of reliability analysis based on dependent variable and independent variable.

Table 8: Reliability Analysis

Variable	Number of Items	Cronbach's Alpha
challenges	10	0.703
Cooperation	10	0.837
Recognition	10	0.871
Student motivation	10	0.836

Table 3 shows the result of the reliability analysis based on the dependent variable and each independent variable. The dependent variable which is student motivation with 10 questions has Cronbach's Alpha value of 0.836 which is good and acceptable. For the first independent variable, challenges factors with 10 questions shows Cronbach's Alpha value of 0.703 which is good, reliable and acceptable. The second independent variable, cooperation factors which contains 10 questions shows the Cronbach's Alpha value of 0.837 which is reliable and very good. The third independent variable, recognition factors with 10 questions in the questionnaire provided has Cronbach's Alpha value of 0.871 which has very good internal consistency.

### Result of Pearson Correlation Analysis

Table 4 shows the result of Pearson correlation analysis based on the hypothesis.

Table 9: Pearson Correlation Analysis

Hypothesis	P-Value	Result (Supported/ Not Supported)
------------	---------	-----------------------------------

<b>H<sub>1</sub> - There is a significant relationship between the challenges and student motivation after returning to the University Malaysia Kelantan City Campus..</b>	0.424	H1 is supported
<b>H<sub>2</sub> - There is a significant relationship between cooperation and student motivation after returning to the University Malaysia Kelantan City Campus.</b>	0.999	H2 is supported
<b>H<sub>3</sub> - There is a significant relationship between recognition and student motivation after returning to the University Malaysia Kelantan City Campus.</b>	0.760	H3 is supported

Table 4 shows the result of Pearson correlation analysis based on the hypothesis. According to the results, the significant p-value of H<sub>1</sub> is 0.001 which is below 0.05 and the p-value is under 0.05. Thus, the study can reject the null hypothesis. Pearson Correlation value of 0.424 stipulates the strength of the relationship between challenges factors and student motivation is moderate and the result is supported. Next, the significant p-value of H<sub>2</sub> is 0.001 which is below 0.05 and the p-value is under 0.05. Thus, the study can reject the null hypothesis. Pearson correlation value of 0.999 stipulates the strength of the relationship between cooperation factors and student motivation is strong and the result is supported. Lastly, the significant p-value of H<sub>3</sub> is 0.001 which is below 0.05 and the p-value is under 0.05. Thus, the study can reject the null hypothesis. Pearson Correlation value of 0.760 stipulates the strength of relationship between recognition factors and student motivation is moderate and the results also is supported.

## **DISCUSSION AND RECOMMENDATION**

The discussion aims to solve the question and address the hypothesis as stated in the first chapter of this study. In general, this study has extensively studied the motivational factors of students after returning to campus among students at Universiti Malaysia Kelantan City Campus. Based on the findings of the study, each individual has different attitudes and thoughts about student motivation. The results of the motivational challenge factor showed a weak correlation using Pearson's correlation. It shows students who lack knowledge about challenges will affect their studies. Students stated that they prefer to feel relaxed when studying and when they are stressed especially if they have a lot of assignments to complete. This is because they can calm themselves down.

Students also usually learn without taking knowledge of the motivation. This unhealthy attitude will affect student performance. One of the best options to overcome student motivation is to create an interesting atmosphere when studying in class. This is because students will know what they will learn and be enthusiastic when learning. In addition, different family backgrounds and lack of guidance when studying cause the challenge factor of student motivation to weaken. Students have different perceptions about student motivation choices. From this study, some students from high-income families tend to have learning motivation and most students from low-income families tend to have less learning motivation. Future research still needs to improve on this study. As a result, to improve the quality of the output from future investigations, several suggestions have been created. The first suggestion is that utilizing quantitative approaches would improve and increase the effectiveness of this investigation. This is because it may assist researchers in doing future studies with outcomes that are more precise and higher in caliber.

The next step is for academics to disseminate survey questions in a more official manner if they are provided online. In addition, a letter of approval from the institution or superiors is required to conduct the research, along with questionnaires. This is done to ensure that the respondents have faith in the survey and don't hesitate to reply to the questionnaires that were issued since the survey was included with the letter of confirmation.

In addition, researchers may narrow the reach of the target respondents or more focused respondents for the next studies. This is done because the researchers feel it is acceptable given the study's title and to prevent imbalances among the respondents when the survey's findings are released. Returning to the initial suggestion, defining the characteristics of the respondents may help researchers get reliable findings. These suggestions are created for use in future research and may assist researchers in further enhancing the study that will be conducted.

## **CONCLUSION**

In conclusion, this study was conducted to find out student motivation after returning among students at Universiti Malaysia Kelantan City Campus. Three independent variables namely challenge factor, cooperation factor and appreciation factor were selected to study their relationship with the dependent variable which is student motivation after returning to campus. A total of 327 respondents aged 19 years and above were selected from 1st to 4th year FHPK students at Universiti Malaysia Kelantan to study their knowledge of student motivation after returning to campus. Overall, based on Pearson's correlation analysis, the cooperation factor has the strongest correlation compared to the challenge factor and the recognition factor followed by the challenge factor and the recognition factor, represented by the correlation ( $0.999 > 0.760 > 0.424$ ).

## REFERENCES

- Akter, M., Sadekin, M. N., & Patwary, A. K. (2020). An Empirical Study on Students' Satisfaction from Mawlana Bhashani Science & Technology University, Bangladesh. *Review of Economics and Development Studies*, 6(2), 363-379.
- Albrecht, J. R., & Karabenick, S. A. (2017). Relevance for Learning and Motivation in Education. *The Journal of Experimental Education*, 86(1), 1-10.
- Alom, S., Patwary, A. K., & Khan, M. M. H. (2019). Factors affecting the turnover intention of Bangladeshi migrants in the United Arab Emirates: An empirical study on the hotel industry. *International Journal of Innovation, Creativity and Change*, 8(3), 344-360.
- Anjana B. S. (2021). *Scales of Measurement in Research*. Introduction to Research in Social Sciences.
- APA PsycNet. (2023). Apa.org
- Baeten, M., Filip Dochy, & Katrien Struyven. (2013). The effects of different learning environments on students' motivation for learning and their achievement. *British Journal of Educational Psychology*, 83(3), 484-501.
- Berestova, A., Burdina, G., Lobuteva, L., & Lobuteva, A. (2022). Academic Motivation of University Students and the Factors that Influence it in an E-Learning Environment. *Electronic Journal of E-Learning*, 20(2), pp201-210.
- Braver, T. S., Krug, M. K., Chiew, K. S., Kool, W., Westbrook, J. A., Clement, N. J., Adcock, R. A., Barch, D. M., Botvinick, M. M., Carver, C. S., Cools, R., Custers, R., Dickinson, A., Dweck, C. S., Fishbach, A., Gollwitzer, P. M., Hess, T. M., Isaacowitz, D. M., Mather, M., & Murayama, K. (2014). Mechanisms of motivation-cognition interaction: challenges and opportunities. *Cognitive, Affective, & Behavioral Neuroscience*, 14(2), 443-472
- Christina. (2018, August 29). *Ideas to Help Students Experience Challenges & Persevere*.
- Cook, D. A., & Artino, A. R. (2016). Motivation to learn: an overview of contemporary theories. *Medical Education*, 50(10), 997-1014.
- Cooperative Learning: Where Behavioral and Humanistic Approaches to Classroom Motivation Meet | The Elementary School Journal: Vol 88, No 1*. (2023). The Elementary School Journal.
- Cooperative Learning: Where Behavioral and Humanistic Approaches to Classroom Motivation Meet | The Elementary School Journal: Vol 88, No 1*. (2023). The Elementary School Journal.
- Edgar, S., Carr, S. E., Connaughton, J., & Celenza, A. (2019). Student motivation to learn: is self-belief the key to transition and first-year performance in an undergraduate health professions program? *BMC Medical Education*, 19(1)
- Fengmin, Z., Baijun, W., Jiangtao, B., Li, L., & Patwary, A. K. (2022). Investigating revisit intention of medical tourists in China through nutritional knowledge, perceived medical quality, and trust in the physiologist: A recommendation on health tourism policy measures. *Frontiers in Public Health*, 10, 893497.
- Fernández-Espínola, C., Abad Robles, M. T., Collado-Mateo, D., Almagro, B. J., Castillo Viera, E., & Giménez Fuentes-Guerra, F. J. (2020). Effects of Cooperative-Learning Interventions on Physical Education Students' Intrinsic Motivation: A Systematic Review and Meta-Analysis. *International Journal of Environmental Research and Public Health*, 17(12), 4451.
- Filgona, J., Sakiyo, J., Gwany, D. M., & Augustine Ugwumba Okoronka. (2020, September 11). *Motivation in Learning*. ResearchGate; Sciencedomain International.

- Georgiou, Y., & Kyza, E. A. (2018). Relations between student motivation, immersion and learning outcomes in location-based augmented reality settings. *Computers in Human Behavior, 89*, 173–181
- Gillett-Swan, J. (2017). The Challenges of Online Learning: Supporting and Engaging the Isolated Learner. *Journal of Learning Design, 10*(1), 20.
- Hamid Tohidi. (2012, December 31). *The effects of motivation in education*. ResearchGate; Elsevier.
- Hassandra, M., Goudas, M., & Chroni, S. (2003). Examining factors associated with intrinsic motivation in physical education: a qualitative approach. *Psychology of Sport and Exercise, 4*(3), 211–223.
- Hawthorne, H. (2021, November 17). *Understanding the Importance of Motivation in Education*. The Hub | High-Speed Training; The Hub | High-Speed Training.
- Hazbar, A. M. H., Alem Mohammed, A., & Karim, A. K. A. (2019). An Empirical Study of Factors Influencing hotel customers' online booking Intention. *مجلة العلوم التربوية و الدراسات الإنسانية*, (5), 1-17.
- <https://www.facebook.com/thoughtcodotcom>. (2019). *How to Use Cooperative Learning in the Classroom*. ThoughtCo.
- <https://www.facebook.com/verywell>. (2013). *Understanding Intrinsic Motivation*. Verywell Mind.
- Jansen, D. (2022, September 15). *Research Limitations vs Research Delimitations - Grad Coach*. Grad Coach.
- Kearns, L. (2012). Student Assessment in Online Learning: Challenges and Effective Practices. *MERLOT Journal of Online Learning and Teaching, 8*(3).
- Klaudia Bovermann, & Bastiaens, T. (2020, December). *Towards a motivational design? Connecting gamification user types and online learning activities*. ResearchGate; World Scientific Publishing.
- Kun, A., & Gadanez, P. (2019). Workplace happiness, well-being, and their relationship with psychological capital: A study of Hungarian Teachers. *Current Psychology, 41*(1), 185–199.
- Lazarides, R., Buchholz, J., & Rubach, C. (2018). Teacher enthusiasm and self-efficacy, student-perceived mastery goal orientation, and student motivation in mathematics classrooms. *Teaching and Teacher Education, 69*, 1–10.
- Li, L., Ragavan, N. A., Patwary, A. K., & Baijun, W. (2022). Measuring patients' satisfaction toward health tourism in Malaysia through hospital environment, nutritional advice, and perceived value: A study on Chinese exchange students. *Frontiers in public health, 10*, 893439.
- Li, L., Wu, B., & Patwary, A. K. (2022). How marine tourism promote financial development in sustainable economy: new evidences from South Asia and implications to future tourism students. *Environmental Science and Pollution Research, 29*, 1155-1172.
- Li, L., Wu, B., & Patwary, A. K. (2022). The psychosocial factors affecting chinese Outbound Exchange and mobility students' academic performance during COVID-19. *Frontiers in psychology, 13*, 872516.
- Lumsden, L. S. (2023). Student Motivation. *Research Roundup, 10*(3).
- Middleton, F. (2020, June 26). Reliability vs validity: what's the difference? Retrieved from <https://www.scribbr.com/methodology/reliability-vs-validity/#:~:text=Reliability%20and%20validity%20are%20concepts,the%20accuracy%20of%20a%20measure>. 73
- Mrs. Winter's Bliss.



- Muhammad Ehsan Malik, & Naeem, B. (2013). Towards Understanding Controversy on Herzberg's Theory of Motivation. *World Applied Sciences Journal*, 24(8), 1031–1036.
- Nichols, J. D., & Miller, R. B. (1994). Cooperative Learning and Student Motivation. *Contemporary Educational Psychology*, 19(2), 167–178.
- Patwary, A. K., Roy, B., Hoque, R., & Khandakar, M. S. A. (2019). Process of developing a community based tourism and identifying its economic and social impacts: An Empirical study on Cox's Bazar, Bangladesh. *Pakistan Journal of Humanities and Social Sciences*, 7(1), 1-13.
- ProThesisWriter.com. (2014). *Limitations in Research: What are Limitations in a Study (Examples)*. Prothesiswriter.com
- Rethinking Learner Support: The challenge of collaborative online learning*. (2023). Open Learning: The Journal of Open, Distance and E-Learning.
- Sample size and power*. (2017). Iwh.on.ca.
- Shin, M.-H. (2018). Effects of Project-Based Learning on Students' Motivation and Self-Efficacy. *English Teaching*, 73(1), 95–114.
- Sumethokula, P., Patwary, A. K., Srinuanpanc, B., Srinuanpand, C., Suwandeee, P., Thammathikul, A., & Phanong, W. (2020). The potential of new tour repackaging for creative tourism among entrepreneurs in Nakhon Si Thammarat. *International Journal of Innovation, Creativity and Change*, 13(10), 1752-1771.
- The Challenges of Defining and Measuring Student Engagement in Science*. (2015). Educational Psychologist.
- Thomas, L. (2020, September 7). *Cluster Sampling | A Simple Step-by-Step Guide with Examples*. Scribbr.
- What are Challenges | IGI Global?* (2021). Igi-Global.com.
- Wu, B., Liu, S., Wang, J., Tahir, S., & Patwary, A. K. (2021). Assessing the mechanism of energy efficiency and energy poverty alleviation based on environmental regulation policy measures. *Environmental Science and Pollution Research*, 28, 40858-40870.
- Wu, B., Zhai, B., Mu, H., Peng, X., Wang, C., & Patwary, A. K. (2021). Evaluating an economic application of renewable generated hydrogen: A way forward for green economic performance and policy measures. *Environmental Science and Pollution Research*, 1-15.
- Yashmak, A., Mohamad, Mohd, & Mohd Faisal Mohamed. (2020, November 30). *Faktor Motivasi Teori Dua Faktor Herzberg dan Tahap Motivasi Guru Pendidikan Islam.: Herzberg Two-Factor...* ResearchGate; unknown.
- Zikmund, W. G. (2003). *Basic Data Analysis: Descriptive Statistic*. Health Economics Research Method,
- Zikmund, W. G. (2003). *Basic Data Analysis: Descriptive*. Research Methods (7th ed.) SouthWestern, Ohio

## THE ASSOCIATION BETWEEN FAMILY VALUES AND COPING SKILLS TOWARD DEPRESSION AMONG 3U1I STUDENTS

*Nur Amalina Shahera binti Che Abdul Ghani, Nur Ameira binti Mohd Aris, Nurul Ain binti Saad, Siti Hajar binti Yusuf and Dr. Siti Fatimah binti Ab Ghaffar*

*Faculty of Hospitality, Tourism and Wellness, Universiti Malaysia Kelantan*

*Corresponding email: [fatimah.g@umk.edu.my](mailto:fatimah.g@umk.edu.my)*

---

### ABSTRACT

Depression is one of the most common mental health problems among university students. However, the prevalence of depression among 3u1i university and its factors were remaining unknown. Therefore, a cross-sectional study was carried out among 73 respondents to investigate the relationship between family value and coping skills to the depression level among 3u1i university students. A set of questionnaires including the Depression, Anxiety and Stress Scale (DASS21), Asian Family Characteristic Scale (AFCS) and Brief-COPE were used to measure depression, family values and coping skills, respectively. Data were analysed using descriptive analysis, reliability test and logistic regression. Based on Logistic Regression analysis, family values were found to be a significant protective factor of depression in 3u1i students, whereas, avoidant-based and emotion-based coping skills were significant risk factors of depression in 3u1i students. Future study should develop the depression intervention program among this target group.

**Keywords: Family values, Depression, 3u1i Students, Coping skills**

---

### INTRODUCTION

Depression is a persistently depressed mood that interferes with daily functioning. According to research, stressful life experiences such as poverty, the loss of a loved one, physical disease, or abuse may raise the probability of depression. The typical causes of it are a mix of biological, psychological, and environmental factors. University students face not only challenges related to independent living, but also academic challenges. Next, family values are the fundamental beliefs and principles that direct and govern how members of a household behave and engage with the rest of the community. It is the guiding principle upon which a family is built, and it is frequently passed down from generation to generation. Family values include all conceptions of what constitutes and governs a family, and they are frequently passed down from one generation to the next. University students participating in the 3u1i industrial mode study program are also at risk for depression. A program of study with an industrial focus is the 3u1i

Apprentice Program. Students will spend three (3) years in college concentrating on theory and one (1) year in the workplace gaining practical experience. The prevalence of depression changes every year among university students at the global level, developed countries, developing countries and Malaysia. Then followed by 3 factors related to depression among university students which is biological, psychological and social.

## **SIGNIFICANCE OF THE STUDY**

*Body of knowledge* – added more reading material and can be used by users who want to do more research to understanding upon that element of a correlation with depression about 3UII students.

*Future study* – Students will take into coping skills to measures that can be practiced by themselves against the problem of depression among these students.

*3u1i university students* – Contribution to future studies for university students for self-prevention because there are a lot of studies about the problem of depression among students but no one related to 3UII students.

*University counsellor* – Contribution for university counsellor to convey all information for university students through a motivational programme, a seminar, talks and more to help students from any possibility of depression with prevention from initial stages.

## **LITERATURE REVIEW**

### **Family Value**

The term “family value” in this study refers to the family value scales obtained using the 30 item Asian Family Characteristic Scale (AFCS). (Ramli Musa et al., 2015) Asian families are known for doing activities and exercising together, grinning because everything is peaceful in the family, helping one another. However, my parents don’t understand me (Ramli Musa et.,al 2015)

### **Coping Skill**

Coping may be described as the mobilisation of mind and conduct to handle an internal and external stressful circumstance. It is the term used to distinguish between conscious and

voluntary mobilisation of activities and defensive mechanisms, which are subconscious or unconscious adaptive reactions that both seek to reduce or endure stress. The most often used coping scales are COPE. Coping is divided into three categories: problem-based coping, emotion-based coping, and avoidant coping.

### **The Depression**

Depression is a prevalent mental illness. It is estimated that 5% of people globally are afflicted. A continuous sensation of discontent and a loss of interest or pleasure in once-satisfying or enjoyable activities are its defining traits. It may also interfere with appetite and sleep. Common symptoms include exhaustion and a loss of concentration. The world's most common disability, the depression, is responsible for a sizeable share of the global illness burden. The effects of depression can be chronic or recurrent, and they can significantly affect a person's capacity to function and lead a happy life.

### **Research Hypothesis**

H1: There is significant association between family values and depression among 3u1i university students.

H2: There is significant association between coping skill and depression among 3u1i university students.

## Research Hypothesis

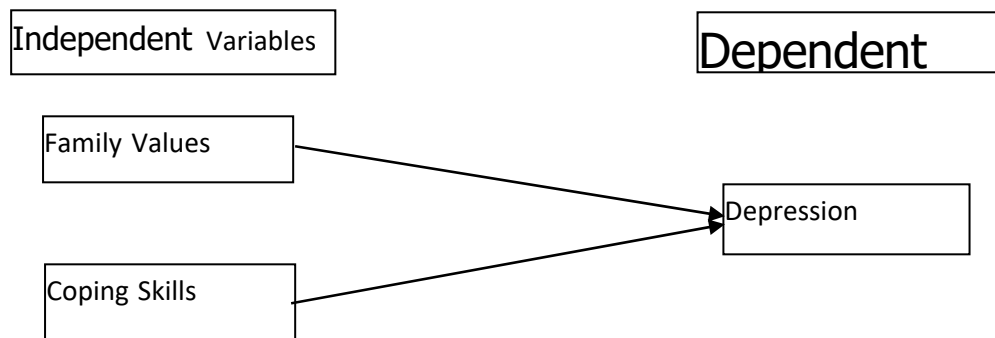

## METHODOLOGY

### Research Design

This study makes use of a questionnaire in to three sections, including part ‘A’ on demographics, part B on family values & coping skill, and part C on depression among 3u1i students. The question in part A contains 4 questions regarding gender and courses taken, whilepart B contains 30 questions for family values and 16 questions for coping skill. There are 21 questions in Part C, a cross sectional study was used, which is a sort of observational researchthat examines data on variables that were gathered at one particular point in time across a sample population or subgroup.

### Data Collection

A questionnaire was given to the respondent using Google Form via WhatsApp or email because it’s simpler to the respondents. The rapid proliferation of social media, the researcher used Google Form and received responses from 3U1i university students.

### Sampling

Given that the researcher was aware of the sample size, a probability sampling method was used in the investigation. Three students from various departments make up the sample size. From that list, the researcher may select 73 of the 90 3U1I university students for the study. Convenient sampling, a non-probability sampling strategy, is one that is frequently employed in clinical and qualitative research. Convenient sampling is popular because it is less

expensive, time-consuming, and simplistic than other sample procedures. Convenience sampling is helpful when used to develop a prospective hypothesis or study objective.

### **Data Analysis**

The method to evaluate and understand the information collected from the respondents is through data analysis.

### **Statistical Package for the Social Sciences (SPSS)**

The SPSS (Statistical Package for the Social Sciences) software bundle is offered as a single package. The main purpose of this programme is to analyse research data from the social sciences. This information can be used for market research, surveys, and data mining. Using the statistical information they have collected, researchers may quickly assess the market demand for a product and modify their plan as necessary.

### **Frequency Analysis**

Another name for frequency analysis is descriptive statistics. Frequency in statistics refers to how frequently an event takes place. An important area of statistics called frequency analysis studies measures of central tendency, dispersion, percentiles, and other occurrences.

### **Descriptive Statistic**

As a result, descriptive statistics for each dependent and independent variable in this study were generated. Users can select pie charts or graphs to display or clarify processed data (SPSS). It uses metrics such as mean, median, and others to make the data simpler for users to comprehend.

## Reliability Analysis (Cronbach's Alpha)

Internal consistency, or how closely connected a set of things are to one another, is measured by Cronbach's alpha. It is recognised as a scale reliability indicator. The metric mightnot be one-dimensional even if alpha has a "high" value.

## INFERENCEAL ANALYSIS (LOGISTIC REGRESSION)

The data obtained is evaluated using logistic regression. A straightforward research used to assess the impact of a direct link between the independent variable (IV) and the dependent variable (DV). Logistic regression is used to examine if the two variables (IV) and (DV) have a connection. If there is a relationship, the researcher must understand how closely the independent variable (IV) and the dependent variable (DV) are associated. The logistic regression coefficient assesses the strength of a two-variable linear connection. It has a value between 0.5 and 0.5, with 0.5 indicating that it is not significant.

## FINDINGS

The conclusions from the previous chapter, "Result and Discussion," which are based on the study's goals, issues, and hypotheses, will be a condensed version of those findings in this study.

### **The relationship encompasses family values and depression among 3uli university students.**

Research question 1 of this study asked about relationship encompasses family values and depression among 3uli university students?

This is also to answer the first objectives and hypothesis.

RESEARCH OBJECTIVES (RO)	RESEARCH QUESTION (RQ)
To investigate the correlations between family value and depression encompasses 3uli college students.	Relationship encompasses family values and depression among 3uli university students.
<b>H1:</b> There is significant association between family value and depression among 3uli university students.	

**Table 1: Research Objective 1 and Research Question 1,**

The results of hypothesis 1 in the previous chapter were reviewed to answer research question 1. In addition, H1 states that there is a significant association between family value and depression among 3u1i university students, it shows a negative relationship which is highly related to depression among 3u1i university students. The p value for family value is 0.000 which is less than the highly significant level of 0.03. Apart from that, there is a relationship between family values and depression among 3u1i university students. Therefore, H1 is accepted.

**The relationship between coping skill and depression among 3u1i university students.**

**Research question 2 of this study ask an about significant relationship between copingskill and depression among 3u1i university students.**

This is also to answer the first objectives and hypothesis.

<b>RESEARCH OBJECTIVE (RO)</b>	<b>RESEARCH QUESTION (RQ)</b>
To investigate the correlations between coping skill and depression encompasses 3u1i college students.	Significant relationship between coping skill and depression among 3u1i university students.
<b>H2:</b> There is significant association between coping strategies and depression among 3u1i university students.	

**Table 2: Research Objective 2 and Research Question 2,**

The results of hypothesis H2 in the previous chapter have been reviewed to answer research question 2. In addition, H2 states that there is a significant association between coping strategies and depression among 3u1i university students. From the findings, it shows that emotion based coping and avoidant based coping are positive related to depression among 3u1i university students compared to problem based coping showing that it is not related to depression among 3u1i university students. The p value for emotion based coping and avoidant based coping is 0.000 which is very significant 0.03 and 0.01. Meanwhile, the problem based coping shows not significant among depression 3U1i, students, similar to the previous study (Ramli Musa et., al 2007). Therefore H2 is accepted.



## **DISCUSSION AND RECOMMENDATION**

### ***Descriptive Analysis***

This research shows the results of our study for the percentage of gender is 84.4% for women and 15.6% for men. This is due to the fact that the majority of FHPK faculty is women, with fewer men available to complete the questionnaire. The second reason is that the majority of 3U11 students are many female students, especially those who work in the spa field and we also know that nowadays there are more female students than male students who are in the university. While the percentage of age is 20-21(2.2%), 22-23 (11.1%) and 24-25 (86.7%) among students 3u1i. Based on previous studies, it shows equality in terms of gender (Nuran et al.,2008). Age also demonstrates similarities because many students have finished their education and have entered the workforce by the time they are 24 to 25 years old. The second reason is that STPM graduates who are between the ages of 24 and 25.

In this research, we have carried out our results for the percentage of ethnicity. The majority of 3u1i university students were Malay 73.3% because the students at University Malaysia Kelantan have many Malay students and the distribution of the population in Malaysia also has Malays. In our study, majority our respondent was malay. However, the previous study shows the majority of respondent was indian among university students 45% (Keong et., al 2018). The reason of involvement ethnicity Malays in the 3U1i university student program was more than that of Indians, and Chinese who choose to study at the university instead of being in industry for a long time. In addition, the majority of FHPK students are Malay compared to other races.

In this research, we have carried out our results for the percentage of course. The majority of students 3u1i university students were SAS 35.6%. Compared to previous studies showing the prevalence of course, tourism and hospitality which is 50.5% and 25.7% among tourism and hospitality management internship students (Armah et., al 2021). The reason why not the same with previous study because 3u1i program not the same with internship and it's different study mode. The majority of students in this study from the SAS course they give response because they work less. Compared with students SAP and SAH has a lot of work. Another reason SAS students decided to take the time to answer the questionnaire was that the title of the final-year project was relevant and done by SAS students themselves.

The prevalence of depression in this study was 64.4% among 3u1i students compared to the previous study with 53.9% among bachelor students (Wong et al., 2023). This could be because the population in prior studies was bachelor's students at the university, but the target population in the study was industrial placement students. According to (Naidu et al., 2019) student in industry maybe poor social support from their friends to express feelings because of pressure in the industry and limited time for personal pursuits compare to bachelor students that only stays in the university. According to (M Zehr & Korte, 2020) different workloads also can affect depression rates, for example, students in industry got more job to do in a short period compared to students in the university.

### ***Inferential Analysis***

Based on the logistic regression, findings show that there is significant association between depression and family values. It is comparable to the previous study conducted by (Musa R et al., 2019). One probable explanation is that both studies used the same scale to measure Asian Family Characteristics (AFCS) and the Depression, Anxiety, and Stress Scale (DASS21). This could be because one of the domains we measured in the AFCS was family harmony, which can boost people's emotions, whether they are children, teenagers, or students. Other than that, we also measure domains of family conflict where low family conflict can cause less problems in the family. So, this has proven that family values are protective factors which mean the higher family values the lower depression rate.

Based on the results, there was significance association between depression and emotion-based coping among 3U1i university students. This result was similar to the previous study conducted by Cummings et., al 2001. The possible reason is that both of these studies use the same scale to measure the level of depression, which through the DASS-21. In addition, emotion based-coping with 3U1i university students reported that students got support from friends and they also used many strategies to deal with emotions such as seeking professional help and talking to someone to find out something. So, this has proven that emotion-based coping is a risk factor which means that there is a parallel direction because the lower the emotion causes the lower level of depression. There will be parallel directions for the independent variable and the dependent variable.

Based on the result, there is a significant between depression and avoidant based coping which is 0.01. This finding is also consistent with the previous study of Nazila Sayyed. This is probably because of people who exposed to stressor an event also who had depression and anxiety are more likely use more avoidance coping style actively. This issue is related to avoidance coping strategy, which is difficult in the setting and position that could be mentioned for people with depression because of frustration feelings that can lead to their difficulties and also a negative attitude towards the future that leads them to believe that they have limited access. Although the potential role avoidance coping in causing stress has not done yet been investigated, relying in avoidance is especially likely to cause a wide variety of stresses.

The results show that the p-value is not significant between depression and problem-based coping with 0.62 among 3u1i university students. It is comparable to previous studies conducted by (Rathakrishnan et al., 2022). In this case, the same results for p-values were above 0.05. The reason is because the university does not provide exposure from the beginning to reduce depression among students which causes the problem of depression among university students to increase. The study shows that it is not significant because where the findings indicated problem-based coping with being negatively correlated with depression among 3U1I students of FHPK faculty.

The recommendation is to change the data collection method from quantitative to qualitative. This is to make the future researcher not only use the questionnaire but they also can use the face-to-face interview to make the data collection more easy. Secondly, enlarge the target population. The researcher can enlarge it from 3u1i students to all the internship students at University Malaysia Kelantan. This will make it easier to collect data and increased the number of sample data. The researcher can perform a simple random sampling which this method has advantages to represent study population. The third recommendation is, for future study, the researcher will consider using other independent variable to investigate the relationship between coping mechanisms and familial relationships in relation to the problem of depression among 3u1i university students.

## **CONCLUSION**

The main purpose of this research is to examine the association between family values and coping skills towards depression among 3U1I students of FHPK faculty in University Malaysia Kelantan. Overall, the relationship between family values, avoidant-based coping and emotion-

based coping was positive and significant but problem-based coping shows not significant. It is the term used to distinguish between conscious and voluntary activity mobilisation and defence mechanisms, which are subconscious or unconscious adaptive reactions that both seek to reduce or tolerate stress.

## REFERENCES

- Akter, M., Sadekin, M. N., & Patwary, A. K. (2020). An Empirical Study on Students' Satisfaction from Mawlana Bhashani Science & Technology University, Bangladesh. *Review of Economics and Development Studies*, 6(2), 363-379.
- Alom, S., Patwary, A. K., & Khan, M. M. H. (2019). Factors affecting the turnover intention of Bangladeshi migrants in the United Arab Emirates: An empirical study on the hotel industry. *International Journal of Innovation, Creativity and Change*, 8(3), 344-360.
- Fengmin, Z., Baijun, W., Jiangtao, B., Li, L., & Patwary, A. K. (2022). Investigating revisit intention of medical tourists in China through nutritional knowledge, perceived medical quality, and trust in the physiologist: A recommendation on health tourism policy measures. *Frontiers in Public Health*, 10, 893497.
- Hazbar, A. M. H., Alem Mohammed, A., & Karim, A. K. A. (2019). An Empirical Study of Factors Influencing hotel customers' online booking Intention. *مجلة العلوم التربوية و الدراسات الإنسانية*, (5), 1-17.
- Jolayemi, M. (2020b, August 16). *What are family values? Definition and examples from different cultures*. Legit.ng - Nigeria News. <https://www.legit.ng/1353711-family-values-definition-examples-different-cultures.html>
- Li, L., Ragavan, N. A., Patwary, A. K., & Baijun, W. (2022). Measuring patients' satisfaction toward health tourism in Malaysia through hospital environment, nutritional advice, and perceived value: A study on Chinese exchange students. *Frontiers in public health*, 10, 893439.
- Li, L., Wu, B., & Patwary, A. K. (2022). How marine tourism promote financial development in sustainable economy: new evidences from South Asia and implications to future tourism students. *Environmental Science and Pollution Research*, 29, 1155-1172.
- Li, L., Wu, B., & Patwary, A. K. (2022). The psychosocial factors affecting chinese Outbound Exchange and mobility students' academic performance during COVID-19. *Frontiers in psychology*, 13, 872516.
- M Zehr, S., & Korte, R. (2020, February 4). *Student internship experiences: learning about the workplace*. Emerald Insight; Emerald publishing limited. <https://www.emerald.com/insight/content/doi/10.1108/ET-11-2018-0236/full/html>
- Naidu, K., Torline, J. R., Henry, M., & Thornton, H. B. (2019). Depressive symptoms and associated factors in medical interns at a tertiary hospital. *South African Journal of Psychiatry*, 25. <https://doi.org/10.4102/sajpsy.2019.v25i0.1322>
- Patwary, A. K., Roy, B., Hoque, R., & Khandakar, M. S. A. (2019). Process of developing a community based tourism and identifying its economic and social impacts: An Empirical study on Cox's Bazar, Bangladesh. *Pakistan Journal of Humanities and Social Sciences*, 7(1), 1-13.
- Ramli Musa, Nurfatin Shahera Shafiee, Nurul Afiqah Zulkifli, Nur Atira Kamaruzaman, & Ali Sabri Radeef. (2019). Family values and psychological distress among adolescents. Is there any association? A comparison study in Malaysia. *Mediterranean Journal of Clinical Psychology*, 7(1). <https://doi.org/10.6092/2282-1619/2019.7.2037>
- Shamsuddin, K., Fadzil, F., Ismail, W. S. W., Shah, S. A., Omar, K., Muhammad, N.A., Jaffar, A., Ismail, A., & Mahadevan, R. (2013b). Correlates of depression, anxiety and stress among Malaysian university students. *Asian Journal of Psychiatry*, 6(4), 318-323. <https://doi.org/10.1016/j.ajp.2013.01.014>

- Sumethokula, P., Patwary, A. K., Srinuanpanc, B., Srinuanpand, C., Suwandee, P., Thammathikulf, A., & Phanong, W. (2020). The potential of new tour repackaging for creative tourism among entrepreneurs in Nakhon Si Thammarat. *International Journal of Innovation, Creativity and Change*, 13(10), 1752-1771.
- Wong, S. S., Wong, C. C., Ng, K. W., Bostanudin, M. F., & Tan, S. F. (2023). Depression, anxiety, and stress among university students in Selangor, Malaysia during COVID-19 pandemics and their associated factors. *PLOS ONE*, 18(1), e0280680. <https://doi.org/10.1371/journal.pone.0280680>
- Wu, B., Liu, S., Wang, J., Tahir, S., & Patwary, A. K. (2021). Assessing the mechanism of energy efficiency and energy poverty alleviation based on environmental regulation policy measures. *Environmental Science and Pollution Research*, 28, 40858-40870.
- Wu, B., Zhai, B., Mu, H., Peng, X., Wang, C., & Patwary, A. K. (2021). Evaluating an economic application of renewable generated hydrogen: A way forward for green economic performance and policy measures. *Environmental Science and Pollution Research*, 1-15.

# **Relationship Between Traditional Postnatal Care Services Utilization And Emotional Status Among Women**

*Anis Faznina Binti Muhamad Safrizan, Raja Muhammad Sufirul Aiman Bin Raja Indera, Nur Nadhirah Binti Mohd Kamal, Rosmalinda Binti Roslan \*Siti Fatimah Bt Ab.Ghaffar*

*Faculty of Hospitality, Tourism and Wellness, Universiti Malaysia Kelantan*

*Corresponding email: [fatimah.g@umk.edu.my](mailto:fatimah.g@umk.edu.my)*

## **ABSTRACT**

This is a cross-sectional study to determine the relationship of traditional postnatal care services utilization (massage, hot stone, and body wrap) and postnatal depression (PND). A total of 97 postpartum mothers who utilize traditional postnatal care service in Kelantan was involved in this study. Postnatal mothers completed a set of questionnaires on sociodemographic characteristics, postnatal care service utilization, and the Edinburgh Postnatal Depression Scale (EPDS). The prevalence of PND was 37.1 %. This study has not found a significant association between traditional postnatal care service utilization (massage, hot stone, body wrap) and PND among postpartum mothers.

**Keywords: Postnatal Care Service, Postnatal Depression, Kelantan**

## **INTRODUCTION**

This chapter begins with explanation about the background of the study, problem statement, research questions, research objectives, significance of the study, definition of the terms and lastly closed with the summary of this research. For this chapter, researchers study stress factors that cause postnatal depression in women.

## **SIGNIFICANCE OF THE STUDY**

This study is important because it was carried out to understand how important emotional care is for mothers after giving birth. For mothers who experience postpartum depression, it can damage the growth and safety of the child as well as the mother's ability to care for and bond with her baby. Rarely, do new mothers injure their newborns or themselves. Maternal depression may also cause impaired mother-child relationships and disrupted bonding. PND must be treated and treated as soon as possible for the sake of the mother and her newborn. Therefore, there are several ways to overcome this problem. Among them, taking care of postpartum care. Hormonal imbalances can affect a woman's emotions. With this, postpartum care can help women go through the hormonal and emotional recovery process better.

### **Body Of Knowledge**

This study will contribute to the body of knowledge on the relationship between postnatal care service utilization and emotional status among women. With the presence of people who take care of the mother after giving birth, it can reduce the stress on the mother. All will be carefully looked after by the confinement lady in terms of sleeping, taking care of nutrition, body wrap and not forgetting to take care of the baby. Confinement lady also communicates a lot with the mother.

### **Future Study**

This research will provide useful findings of study to develop intervention programs in reducing, minimizing PND among postpartum mothers.

### **Traditional Postnatal Care Services Provides**

Abstinence after childbirth is a traditional practice after a mother gives birth. For pregnant mothers, it is important to take care of emotions. Therefore, aftercare is very important. With postnatal care, the mother's emotions will be awakened because everything has been done by the confinement lady such as body massage, hot stone and body wrap.

## **LITERATURE REVIEW**

### **Research Hypothesis**

This study investigates the relationship among these discussed variables. Based on the literature discussed, the hypotheses of this study were summarized in the following manner:

H1. There is a significant association between postnatal massage service utilization and postnatal depression among postpartum mothers.

H2. There is a significant association between hot stone of traditional complementary medicine compression service utilization and postnatal depression among postpartum mothers.

H3. There is a significant association between body wrap treatment service utilization and postnatal depression.



## Research Framework

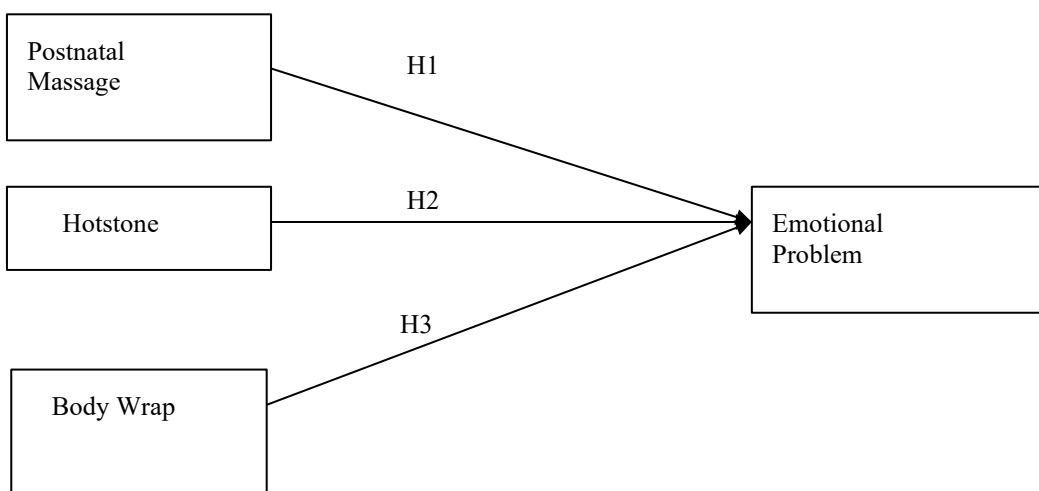

Figure 1: The research framework used for this study.

## METHODOLOGY

### Research Design

There are two types of approach which are quantitative and qualitative. The research type in this study is quantitative. Quantitative approach is a technique of collecting, analyzing, interpreting and writing the data that the researcher got for the study. The approach of using quantitative will aid the research in obtaining data through the responding to relational questions of variables in study. Researchers only distributed the questionnaire once.

A cross-sectional study is a style of research design in which gather information from a larger number of individuals all at once. In cross-sectional research, variables are observed without being changed. (Lauren Thomas, 2020). A cross-sectional study design has the advantages of enabling researchers to compare numerous factors at once. A particular research technique used to gather information from a specific point in time is a cross-sectional study. The data was gathered from a set of volunteers known as variables, each of whom had distinctive characteristics and demographic. Age, gender, income, education, geography, and ethnicity are just a few examples of variables. Quantitative approaches tend to address research problems that require a description of tendencies or an explanation of the relationship between independent variables and dependent

variables. The analysis obtained will provide information about the mother's emotional status after childbirth.

### **Data Collection**

There are several collection methods in a research project. The information used in this study came from primary sources. The survey used in this research will be a questionnaire through the Google Form. The questionnaire is applied to collect the information about factors that are associated with emotional status among women after birth. The questionnaire was distributed to all customers that used service utilization at Confinement Centre in Kelantan. The questionnaire also was distributed through online platform like WhatsApp and Facebook.

### **Sampling**

Sample selection in this study was based on the researcher's subjective assessment rather than a selection from a random sample, a non-probability sampling approach was chosen. Due to the fact that the samples are selected at random, the researcher will employ the non-probability technique. Because the researcher is familiar with the specific characteristics of the population or respondents, purposive sampling will be used in this study. Mothers who use the Confinement Centre in Kelantan are the respondents.

### **Data Analysis**

Data analysis might come in primary data and secondary data. The most popular data collection method is the questionnaire since it allows the researcher to quickly gather a large number of replies because each responder was required to answer the same set of questions. Researchers can analyze data using the SPSS program to make predictions about group identification, numerical outcomes, and descriptive and bivariate statistics. The data will be gathered, transmitted, and analyzed using SPSS using Microsoft Excel. It assists researchers in fully comprehending the data supplied and includes the relevant details to help put the findings into context. Logistics regression is a useful tool to determine the strength of the linear relationship between the independent variable (IV) and the dependent variable (DV).

## **FINDINGS**

There have been several significant discoveries from research on the use of services for postnatal mothers' emotional health. First off, it has been noted that a sizable proportion of postnatal mothers struggle with emotional issues such as postpartum depression and anxiety. The mother's wellbeing and her capacity to care for her new born may be negatively impacted by these emotional difficulties.

Second, there is proof that postnatal moms' mental well-being can be improved by having access to and using support services from utilization services. According to studies, moms who use services like counseling, home visiting programmers, and postpartum support groups are likely to have better emotional results. These services give mothers a safe place to express their emotions, develop coping mechanisms, and get expert advice.

- In a study conducted, it was found that utilization services resulted in a significant stabilization of emotional status.
- A survey of 97 customers revealed that 80% of them suffered from the emotional stress during postnatal due the new-born.
- Analysis of financial data from the experienced customers indicated a positive correlation between utilization services and emotional status.

## **DISCUSSION AND RECOMMENDATION**

### **TRADITIONAL POSTNATAL MASSAGE**

This study found no significant association between traditional postnatal care service which is postnatal massage and PND. In contrast, Azidah et al, 2006 discovered that using postnatal massage services was a significant protective factor for PND, demonstrating that relaxing postnatal massage has a protective effect on the development of PND. Most postpartum mothers have a close friendship with their postnatal massage therapist. Differences in findings between this study and Azidah et al, 2006 could be attributed to a different methodological approach. Respondents in Azidah et al, 2006 were given a questionnaire on three occasions whereas, this study distributed questionnaire for one occasion.

Apart from that, in terms of time frame, Azidah et al's study was conducted in 2006 which was 17 years back, almost 2 decades. However, this study was conducted in the modern era. Indeed, over this time period, there have likely been significant advancements and changes in various

fields, including the subject matter of the research. In addition, there is a week after delivery difference and a 17-year age difference.

On the other hand, previous study mentioned that postnatal massage in Malaysia involves a deep tissue and therapeutic whole body massage performed by experienced Malay midwives. The massage technique starts from the top of the head and ends at the feet (Zuraidah Mohd Yusoff et al, 2018). Postnatal massage is deeply rooted in cultural traditions and beliefs. It is believed to aid in weight loss, toning the skin, enhancing blood circulation, and reducing body pain and numbness after childbirth. The utilization of postnatal massage services may vary across different cultures based on the availability of trained practitioners and cultural norms surrounding postpartum care.

### **HOT STONE COMPRESSION**

There is also no significant association between traditional postnatal care service, hot stone compression with PND. However, according to a previous systematic review found different finding. The systematic review used search strategy on the research trend for the period between the years 2013 to 2020 through the Scopus database, Science Direct, and PubMed database. The review has identified 7 journal articles based on the preferred reporting items for the systematic reviews (PRISMA) framework. The systematic review reported that hot stone compression is significantly protective to postpartum health and can firm the stomach and relieve stomach pains (Sator et al, 2022). Apart from that, warm foot compresses are recommended since it can help to smooth out veins (Adilla Nur & Aidatul Azura, 2017). These effects could improve emotional status among postpartum mothers.

Hot stone compression is performed using heated objects known as 'tungku.' Two types of 'tungku' are mentioned: iron 'tungku' and stone 'tungku.' These heated objects are placed on herbal leaves such as *Alpinia galangal* and *Morinda Citrifolia* before being wrapped in a cloth. Hot stone compression is believed to aid in uterine contraction and dissolve blood clots in the uterus. It is seen as a therapeutic practice in postnatal care. The use of specific herbal leaves and the choice of 'tungku' weight reflect cultural beliefs and practices aimed at promoting physical recovery and healing after childbirth.

### **BODY WRAP**

Besides, finding of this study has not found significant association between traditional postnatal care service which is body wrap and PND. However, application of a body wrap is strongly advised

to restore the pre-pregnancy body shape (Adilla Nur & Aidatul Azura, 2017). According to Abdulrahman et al, (2018), a traditional medicinal (body wrapping) system is a body of comprehensive knowledge, belief, and practice that is used or underused by individuals to address health issues or improve their health status. These individuals then pass on the accumulated information or knowledge to succeeding generations.

Limited number of published evidence on the effect of body wrap among postnatal mothers including its relationship with postnatal depression (PND). It is difficult to draw any inferences about their potential impact on PND. Further research is necessary to explore the effects of these traditional practices and to establish a clearer understanding of its relationship with PND.

Body wrap, known as *barut* or abdominal binding, involves applying an herbal paste made from specific herbs and spices to the abdomen before tightly wrapping it with a long cloth. The wrap covers the abdomen area from beneath the breast to the thighs. Body wraps aim to restore and deflate the abdomen, regain the mother's original body posture and shape, and provide support to the abdominal muscles. Body wraps are commonly used in various cultures to promote healing, provide warmth, and aid in toning the postpartum body. The specific herbs and spices used in the herbal paste may vary based on cultural beliefs and traditional medicinal practices. However, the effectiveness of these services in terms of their therapeutic benefits and impact on emotional well-being may vary among individuals. Cultural considerations should be taken into account when providing postpartum care, as these practices may hold significant meaning and value for women in Malaysia.

## **RECOMMENDATION**

Firstly, a larger sample size improves the power of study. By including more respondents, the likelihood of obtaining misleading or random results decreases, leading to more trustworthy conclusions. Secondly, a larger sample size enhances the representativeness of the study. It allows for a more diverse and varied group of respondents, enabling researchers to apply their findings to a broader population or target group. This increases the external validity or generalizability of the research.

For future study, it is recommended to use simple sampling random methods. Utilizing simple random sampling can enhance the quality of this study. By employing this method, each member of the population has an equal chance of being included in the sample, reducing bias and increasing the generalizability of the findings.

## CONCLUSION

The subject of this research is a study titled “Relationship between traditional postnatal care services utilization and emotional status among women.” The purpose of this study was to investigate the use of postnatal care services. Besides that, also to investigate the mother's emotions after giving birth. However, this study has not found a significant association between traditional postnatal care services utilization (postnatal massage, hot stone compression and body wrap) and PND among postpartum mothers. The prevalence of a PND among postpartum mothers in this study 37.1 %.

## REFERENCES

- Akter, M., Sadekin, M. N., & Patwary, A. K. (2020). An Empirical Study on Students' Satisfaction from Mawlana Bhashani Science & Technology University, Bangladesh. *Review of Economics and Development Studies*, 6(2), 363-379.
- Al Mahmud, S. R. (2020). The effectiveness of Facebook advertisements on purchase intention of customers in Malaysia. *South Asian Journal of Social Sciences and Humanities*, 1(1), 97-104.
- Alom, S., Patwary, A. K., & Khan, M. M. H. (2019). Factors affecting the turnover intention of Bangladeshi migrants in the United Arab Emirates: An empirical study on the hotel industry. *International Journal of Innovation, Creativity and Change*, 8(3), 344-360.
- Azidah AK;Shaiful BI;Rusli N;Jamil My. (2006). Postnatal depression and sociocultural practices among postnatal mothers in Kota Bahru, Kelantan, Malaysia. *The Medical journal of Malaysia*. <https://pubmed.ncbi.nlm.nih.gov/16708738/>
- Fengmin, Z., Baijun, W., Jiangtao, B., Li, L., & Patwary, A. K. (2022). Investigating revisit intention of medical tourists in China through nutritional knowledge, perceived medical quality, and trust in the physiologist: A recommendation on health tourism policy measures. *Frontiers in Public Health*, 10, 893497.
- Guodong Ding, L. N. (2020, March). Doing the month” and postpartum depression among Chinese women: A Shanghai prospective cohort study. Retrieved from <https://www.sciencedirect.com/science/article/abs/pii/S1871519218302221>
- Hazbar, A. M. H., Alem Mohammed, A., & Karim, A. K. A. (2019). An Empirical Study of Factors Influencing hotel customers' online booking Intention. *مجلة العلوم التربوية و الدراسات الإنسانية*, (5), 1-17.
- Justine Slomian, G. H. (2019, April 29). Consequences of maternal postpartum depression: A systematic review of maternal and infant outcomes. Retrieved from <https://journals.sagepub.com/doi/full/10.1177/1745506519844044>
- Li, L., Ragavan, N. A., Patwary, A. K., & Baijun, W. (2022). Measuring patients' satisfaction toward health tourism in Malaysia through hospital environment, nutritional advice, and

perceived value: A study on Chinese exchange students. *Frontiers in public health*, 10, 893439.

- Li, L., Wu, B., & Patwary, A. K. (2022). How marine tourism promote financial development in sustainable economy: new evidences from South Asia and implications to future tourism students. *Environmental Science and Pollution Research*, 29, 1155-1172.
- Li, L., Wu, B., & Patwary, A. K. (2022). The psychosocial factors affecting chinese Outbound Exchange and mobility students' academic performance during COVID-19. *Frontiers in psychology*, 13, 872516.
- Mariya Chalise, Isha Karmacharya, Maheshor Kaphle, Ayurma Wagle, Natasha Chand, and Laxmi Adhikari. (2020). Factors Associated with Postnatal Depression among Mothers Attending at Bharatpur Hospital, Chitwan. Retrieved from: <https://www.hindawi.com/journals/drt/2020/9127672/?limit=all>
- Martina Smorti, L. P. (2019, October 24). A Comprehensive Analysis of Postpartum Depression Risk Factors: The Role of Socio-Demographic, Individual, Relational, and Delivery Characteristics. Retrieved from <https://www.frontiersin.org/articles/10.3389/fpubh.2019.00295/full>
- Mohamad Yusuff, A. S., Tang, L., Binns, C. W., & Lee, A. H. (2015). Prevalence and risk factors for postnatal depression in Sabah, Malaysia: A cohort study. *Women and Birth*, 28(1), 25–29. <https://doi.org/10.1016/j.wombi.2014.11>.
- Mohd Arifin, S. R., Cheyne, H., & Maxwell, M. (2018). The context of postnatal depression in Malaysia: An overview. *Volume-10: Issue, 10(1), 57-65*. <https://doi.org/10.31674/mjn.2018.v10i01.008>
- O Aloba, T. O. (2019, May 17). Retrieved from Suicidality among Nigerian postpartum women: Prevalence and correlates: <https://www.tjgonline.com/article.asp?issn=0189-5117;year=2019;volume=36;issue=3;spage=391;epage=397;aulast=Opakunle>
- Patwary, A. K., Roy, B., Hoque, R., & Khandakar, M. S. A. (2019). Process of developing a community based tourism and identifying its economic and social impacts: An Empirical study on Cox's Bazar, Bangladesh. *Pakistan Journal of Humanities and Social Sciences*, 7(1), 1-13.
- Sample Size Determination Using Krejcie and Morgan Table. (2021, February). Retrieved from [https://www.researchgate.net/publication/349118299\\_Sample\\_Size\\_Determination\\_Using\\_Krejcie\\_and\\_Morgan\\_Table](https://www.researchgate.net/publication/349118299_Sample_Size_Determination_Using_Krejcie_and_Morgan_Table)
- Sator, P., Mamat, R., Syed Abdul Rahim, S. S., Kim, G.-C., Saimon, R. A/P Darsin Singh, S. K., & Sawatan, W. (2022). The health and wellness benefits of traditional postnatal practice (TPC) on postnatal mothers: A systematic review. *NOVEMBER ISSUE*, 18(6), 286-294. <https://doi.org/10.47836/mimhs.18.6.37>
- Shafaly Shorey, C. Y. (2018). Prevalence and incidence of postpartum depression among healthy mothers: A systematic review and meta-analysis. Retrieved from <https://www.sciencedirect.com/science/article/abs/pii/S0022395618304928>
- Sumethokula, P., Patwary, A. K., Srinuanpanc, B., Srinuanpand, C., Suwandee, P., Thammathikul, A., & Phanong, W. (2020). The potential of new tour repackaging for

creative tourism among entrepreneurs in Nakhon Si Thammarat. *International Journal of Innovation, Creativity and Change*, 13(10), 1752-1771.

Wu, B., Liu, S., Wang, J., Tahir, S., & Patwary, A. K. (2021). Assessing the mechanism of energy efficiency and energy poverty alleviation based on environmental regulation policy measures. *Environmental Science and Pollution Research*, 28, 40858-40870.

Wu, B., Zhai, B., Mu, H., Peng, X., Wang, C., & Patwary, A. K. (2021). Evaluating an economic application of renewable generated hydrogen: A way forward for green economic performance and policy measures. *Environmental Science and Pollution Research*, 1-15.

Ziyi Wang, J. L. (2021, December 20). Mapping global prevalence of depression among Bhat, A. (2018, August 8). *Research Design: What it is, Elements & Types* | QuestionPro. Retrieved January 6, 2023, from QuestionPro website: <https://www.questionpro.com/blog/research-design/> postpartum women. Retrieved from <https://www.nature.com/articles/s41398-021-01663-6>

Zuraidah Mohd Yusoff, Asmiaty Amat, Darlina Naim and Saad Othman. (2018). Postnatal Care Practices among the Malays, Chinese and Indians: A Comparison. Retrieved from: [https://www.shs-conferences.org/articles/shsconf/abs/2018/06/shsconf\\_iclk2018\\_05002/shsconf\\_iclk2018\\_05002.html](https://www.shs-conferences.org/articles/shsconf/abs/2018/06/shsconf_iclk2018_05002/shsconf_iclk2018_05002.html)



# THE ASSOCIATION BETWEEN PARENTAL EMOTIONAL STYLES AND EMOTIONAL PROBLEMS AMONG PRESCHOOL CHILDREN

NURUL IZZAH BINTI MOHD YUSOFF, AMIRAH BALQIS BINTI ROSLAN  
NURHAIRUNNISA BINTI HAIRUL NIZAM, NURUL ATIKA KHALID & DR. SITI  
FATIMAH BINTI AB. GHAFFAR\*

Faculty of Hospitality, Tourism and Wellness, Universiti Malaysia Kelantan  
Corresponding email:

---

## ABSTRACT

---

**Introduction:** Emotional problem is one of the common mental health problems in children. Thus, this study aimed to investigate the relationship between parental emotional styles and emotional problem among preschool children. **Methods:** A cross-sectional study was conducted in preschool in Kota Bharu and Machang. A set of questionnaires consisted of the PESQ and the SDQ were distributed using Google Form as well as hardcopy of questionnaire for data collection. Data were analysed using Logistic Regression (LR). The significance value was set at  $p < 0.05$ . **Results:** A total of 92 parents of preschool school was involved in this study. The majority of respondents were females (80.4%), and married (94.7%). All parents were Malay Muslim with mean age(year), 33.61, and mean household income(RM), 5429.34. Based on the LR, parental age ( $p = 0.003$ ) was significantly. However, emotional coaching ( $p = 0.338$ ) and emotional dismissing ( $p = 0.923$ ) were not significant. **Conclusion:** Parental age was significant predictor of emotional problem in preschool children.

---

**Keywords:** Parenting Style, Emotional Problem, Preschool Children

---

## INTRODUCTION

A recent local study showed that parental factors were significantly associated with mental health problems in children. Parenting style were found to influence the development of mental health problems (Idris, 2019). Parental emotional style was introduced by (Gottman, 1977) known as emotion coaching. Interestingly, there are five main phases to raise emotionally intelligent child. First, parents need to be aware of a child's emotions. Second, a child's emotion is viewed as a chance for intimacy and teaching. Third, parents need to validate the child's emotion. Fourth, parents should assist the child in labelling the emotion verbally by using correct emotion words, and lastly, help the child to solve the problem, if needed. This approach was reportedly effective in preventing emotional problems in children (Havighurst, 2022). The researcher contributes the body of knowledge of the association between emotion coaching parenting style and emotional problem among pre-school children. With this study, it can help solve emotional problems among pre-school children in the future. This is said to be so because parents can be educated about how important it is to manage children's emotions well so that emotional problems among pre-school children do not last until adulthood through parenting programs.

## SIGNIFICANCE OF THE STUDY

The researcher contributes the body of knowledge of the association between emotion coaching parenting style and emotional problem among pre-school children. With this study, it can help solve emotional problems among pre-school children in the future. This is said to be so because parents can be educated about how important it is to manage children's emotions well so that emotional problems among pre-school children do not last until adulthood through parenting programs.

Parents can practice emotion coaching so that their children can manage their emotions well. Parents also need to apply emotional management practices by asking how their child is feeling that day. This situation is because children are not good at expressing what they feel instead they will show it through behaviour.

Teachers and caregivers are the closest people to pre-school children at school. The teacher throughout the learning period can see the development of pre-school children. Most pre-school children with emotional problems will feel unmotivated to go to school. They will also show a declining development in terms of learning. However, the teacher must also be concerned with the condition of the students so that the emotional problems that occur in pre-school circles can be successfully overcome.

## **LITERATURE REVIEW**

### ***Prevalence of Emotional Problem***

The study shows that the percentage of emotional problem in global level between 10 to 20%. A meta-analysis of some study has been carried out between 1985 and 2012 in some countries present that the percentage of mental health problem among preschool children was 13.4% (Sahril et al., 2021). The study shows that, in 2019 during the Covid-19 the prevalence of depression among children and adolescent under 18 years old was 25.2%. Meanwhile, the percentage of anxiety disorder in 2019 was stated that 20.5% in the global level (Racine et al., 2021).

The mental health problem always found in almost every country in the world. Types of emotional problems are stress, anxiety and depression. On the report the developed countries the Australia and New Zealand have the high prevalence of the anxiety 8% - 7.9% in world. Meanwhile the Nigeria 0.1 % is the lowest rate. In 23% of the children, have a combination of attention deficit hyperactivity disorder (ADHD) and related symptoms and social interaction problems was reported by parents (Pediater, 2020).

The percentage of emotional problems among pre-school children were reported in Malaysia still the lower data when compared with other Asian countries such as Vietnam with 12.0%, Bangladesh at 14.6%, China 20.3%, Iran with the percentage is 26.0% (Sahril, 2021). Moreover, in China the anxiety levels of children and adolescents stated about 23% and 29% respectively during the Covid-19 (Li Duan, 2020). Clinical and borderline of Emotional and Behavioural Problem (EBPs) among Kenyan children aged 6-11 years in 2018 was 17% and 27%, respectively (Alenko, 2020).

In Malaysia, different research revealed that 8.5% of respondents with mental health problems among school students were reported by their parents. Based on National Health and Morbidity survey in 2019, prevalence of emotional problems among children was 8.3% (NHMS, 2019). However, the study has stated that the prevalence of emotional problem among preschool children during Covid-19 is 12.7% (Jenny Lou Barican, 2021). The largest prevalence of mental health issues was seen among children aged 5 to 9 years, where it was 13.1%, compared to older children aged 10 to 15 years, where it was 11.4% (Tahir Aris, 2015). attention deficit hyperactivity disorder (ADHD) and related symptoms and social interaction problems was reported by parents (Pediater, 2020).

### ***Parental Age***

Parental age is one of the factors related to emotional problems among children. The age of the parents can show whether there is a negative effect or a positive effect on the child's emotions. Children of older parents, especially older moms, do much better in school and at work, score higher on IQ tests, express better health, and have less behavioral and emotional issues than children of younger parents, according to a number of population-based studies. Additionally,

parents who are older tend to be more resilient, use substances like alcohol and drugs less, and have less mental health issues (Zondervan-Zwijnenburg et al., 2019).

According to a 2016 Danish study, older women become more adept at setting limits with their kids and are less inclined to scold or reprimand them harshly, which prevents future behavioral, social, and emotional issues. Additionally, they have less anxiety during pregnancy, have more solid relationships, and are in better financial shape as well as which can improve the parenting experience (Manning-Schaffel, 2017).

Older mothers may have a tendency to adopt a more authoritative parenting style, which Baumrind defined as balancing freedom and control. However, when the kids become older, younger mothers might have greater stamina and develop the maturity of older mothers. For instance, older women might have less energy and health to devote to their children. Researchers examined the general idea that better psychological health in families beyond the preschool years is connected with older mother age in this study. Through this study, the researchers tested their hypothesis that having older mothers would be associated with less verbal and physical restraint and with better socioemotional development of children at 7, 11, and 15 years old (Trillingsgaard and Sommer, 2016).

### ***Parenting Style***

The factors that associated with the anxiety among pre-school children is permissive parenting style. Generalised anxiety added significant explanatory variance for the atypical behaviour in preschool children. Generalized anxiety has a partial mediating effect on the relationship between father's permissive parenting style and atypical behaviour and a total mediating effect on the relationship between mother's permissive parenting style and atypical behaviour (Ciuhan, 2021).

Second factor is authoritative parent. Authoritative parenting style are high responsiveness, high demandingness. Establish clear rules and expectation on their children while practicing flexibility and understanding. Communicates frequently they listen to and take into consideration their children's thoughts, feeling and opinions. Authoritative parent also allow for natural consequence. For example, kids fail quiz when they did not study. But the authoritative parent will use those opportunities to help their kids reflect and learn (Zelster, 2021). Our results suggest that increased authoritativeness of mothers is associated with lower odds of developing anxiety disorders in children.

Third, the common traits of neglectful parent by Diana Baumrind are low responsiveness, low demandingness. Aside from that, neglectful parenting are define by a lack of parental concern in any way has been linked to a children exhibiting higher level of fear, anxiety and distress, as well as engaging delinquent behaviour.

The common traits of authoritarian parent by Diana Baumrind are high demandingness, low responsiveness. Enforces strict rules with little consideration of their kid's feeling or social-emotional and behavioural needs. Authoritative parenting, on the other hand, is cross-culturally associated with lower developmental psychopathology, which has also been shown to constitute a protecting factor against children's anxiety (Yaffe, 2021).

Based on the theorized that emotional coaching and emotional dismissing philosophies are negatively related (Ramsden & Hubbard, 2002). Based on the factors shared by Gottman, there are three factors that he has shared that are related to. parenting style. Among them are dismissing parents, disapproving parents and laissez-faire. Ignoring parents are too busy with work to the point of neglecting their children and they always consider their children's feelings unimportant. This causes the child to become anxious to express all the opinions that they have hidden. Parents with

a rejecting style consider their children's negative emotional experiences as irrational and do not believe in their importance (Ana Poula, 2018). Parental disengagement was examined to see if it mediated the relationship between parental emotion dysregulation and child anxiety, or parental anxiety and child anxiety in two separate models (Engebretsen, 2019).

### ***Factor of Emotional Problem***

The Biopsychosocial Model was first introduced by George Engel in 1977, he suggested that to understand a person's medical condition it is not only necessary to look at biological factors but also psychological and social factors are also important (Porter, 2020).

The word "biological" refers to components that affect human health physiological pathology. A further affect is "age. Children between the ages of 9 and 12 are beginning to comprehend that the same event may trigger both good and negative emotional reactions, and they are expressing their emotions in ways that take into account their environment and the possible implications that these expressions may have on others. As a result of social interaction and cognitive development, children simultaneously acquire new cultural or social norms that are crucial for their understanding of emotions and for their motivation or reluctance to express emotions (Henderson, 2017).

The second factors are "Psychological". It refers to component that deals with thoughts, emotions and behavior. The affect from psychological is temperament. The meta-analytic studies have shown that the children with inhibited or antisocial behavior had four times increases vulnerable to social anxiety problem. The high incidence of, anxiety problem among less socialized children may be because low of behavioral or social inhibition not only the risk factor for anxiety problem but rather, a milder form of the disorder itself, characterized by fear, avoid from anybody and withdrawal from the social situation that has a lot of people. If this matter is not curbed the children will feel constant worry and scared with people (Sahithya and Raman, 2021).

Next, interpersonal relationship also the psychological factor. Children from single parent families were more than twice as likely to report internalising problems and more than three times as likely to report externalising problems. According to studies, children with mother-only families may experience adjustment issues similar to those in families with a mother and a stepfather or an unrelated partner. With another adult in the family, such as a grandparent, the risk is marginally reduced (Aniruddh Prakash Behere, 2017).

The last factor is Social. Social can be define as our ability to communicate, interact and form meaningful relationships with others. These socioeconomic status (SES) inequalities affect not only for parents but also children's lives. In addition, children with low SES suffer more often from health problems than children with high SES (Franziska Reiss, 2019). People with low socioeconomic status will have a lower autonomy to work, corresponding to high level of pressure and emotions became unstable (Yunfan Zhang, 2022).

Family circumstances influence anxiety problems in children. This is because, one of the causes of children experiencing anxiety problems in the family is because of the negative behavior of parents. This also includes excessive control for example setting rules that are too strict, protecting the child in an excessive way, and giving instructions for the child to think very quickly. In addition, parents who criticize more than teach children can make children afraid to interact with their parents (Jenny Draisey, 2019).

### **Research Hypothesis**

H1: There is significant association between age and emotional problem among preschool children.

H2: There is significant association between emotional coaching parental style and emotional problem among preschool children.

H3: There is significant emotion dismissing parenting style and emotional problem among preschool children.

### Research Framework

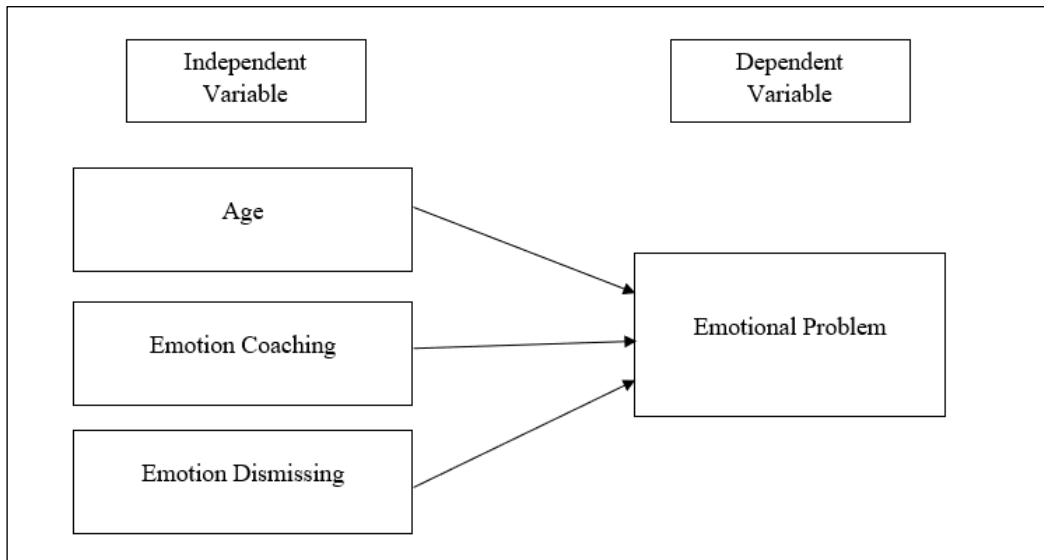

## METHODOLOGY

### Research Design

Research design is a structure for planning and implementing a specific design. In this study, the research design used is cross-sectional study. It is an observational study that analyses data from a population in one time. Cross-sectional study widely used to measure the prevalence, determine the factor and explain the population characteristics. This type of study also used in the early stages of research (Wang and Cheng, 2020).

### Data Collection

In this study, the researcher utilising primary data as a method of gathering data because the data obtained is more relevant. Primary data is usually collected from the source where the statistics were originally obtained and is considered the best type of data in research. Researchers use quantitative in this research because it is more scientific, objective, quick, focused and acceptable. The tool used in this study is a questionnaire through a Google form and distribute the hardcopy questionnaire. The questionnaires by google form were distributed online through “WhatsApp” and collected data among parents of kindergarten students in the Kota Bharu and Machang areas.

### Sampling

As the quantitative research, the purposive sampling is the best methods to collect the data of population for this research. Purposive sampling is chosen because the data can collect quickly and did not take so much time. Purposive sampling also inexpensive to create samples and low cost with less or no investment while collecting the data and purposive sampling are chosen because the researcher cannot access to the parents of pre-schoolers. Hence, sample are readily available and we do not have to move around too much to collect the data for this study.

## Data Analysis

The process of gathering, modelling, and analysing data to support conclusions is defined as data analysis. The Statistical Package for Social Sciences (SPSS) will be used in this study to examine information and data.

The characteristics of measuring scales and the products we make from them may be examined using reliability analysis. The inter-rater reliability approach evaluates how well each test item consistently assesses the concept. This approach comprises giving each item on a test a qualified rate's or judge's rating, then calculating the overall percent agreement between them. The more judges agree on a percentage, the more trustworthy the test is.

Mean, median, and mode are all central tendency measures. Researchers can use these three categories of central tendency to collect and organize data from survey participants or samples using a Google form. This suggests that descriptive analysis seeks to quantify the proportion of respondents who agree or disagree with the assertions made in the questionnaire in connection to emotion coaching parenting style (IV) and emotional problems in preschool (DV).

Inferential statistical analysis will be the methodology used to present the results. To describe data and explain the relationship between one dependent binary variable and one or more independent nominal, ordinal, interval, or ratio-level variables, we use logistic regression. By comparing the amount of shared variation, or covariance, between the items that make up the instrument to the amount of overall variance, Cronbach's alpha is a method for evaluating reliability.

## FINDINGS

### *Descriptive Analysis*

The outcomes of respondents' demographic characteristics are shown that the majority of respondents were female 80.4% and the mean age of respondents is 33 years old. All of the respondents were Malay Muslim (100%). The marital status of majority respondents was married (98.9%) and the mean of household income of respondent is RM 5429.34. The emotional problem of preschool children was categorized into normal and emotional problem. From the table show that 64 out of 92 children (69.6%) are normal and free from emotional problem meanwhile the rest of 28 children (30.4%) are having emotional problem. Parental emotional style has been separated into two that is emotional coaching and emotional dismissing. The mean of emotional coaching is 34.2391 and the standard deviation is 5.98601. The mean of emotional dismissing is 34.0000 while, the standard deviation of emotional dismissing is 4.70212.

Next, the emotional problem of preschool children. The questionnaire for this variable has been classified into normal and emotional problem. Table 4.1 showed that 64 out of 92 children (69.6%) were normal meanwhile remaining 28 children (30.4%) were having emotional problem. Parental emotional style has been categorised into two, namely emotional coaching and emotional dismissing. The mean score of emotional coaching was 34.2391 and the standard deviation was 5.98601. The mean score of emotional dismissing was 34.0000 while, the standard deviation of emotional dismissing was 4.70212. Table 4.1 shows that the descriptive analysis of demographic profile.

Table 4.1: Descriptive Analysis of Demographic Data

Variable	Frequency (n) / Mean	Percentage / Standard Deviation
<b>Gender</b>		
Male	18	19.6
Female	74	80.4
<b>Age</b>	33.61	7.154
<b>Race</b>		
Malay	92	100.0
<b>Religion</b>		
Muslim	92	100.0
<b>Marital Status</b>		
Married	91	98.9
Single Parents	1	1.1
<b>Household Income (RM)</b>	5429.34	3700.217
<b>Emotional Problem</b>		
Normal	64	69.6
Emotional Problem	28	30.4
<b>Parental Emotional Styles</b>		
Emotional Coaching	34.2391	5.98601
Emotional Dismissing	34.0000	4.70212

### *Reliability Test*

Table 4.2: Result of Reliability Test

Variable	Cronbach's Alpha
<b>Emotional Problem</b>	
Emotional Symptoms	0.805
<b>Parental Emotional Styles</b>	
Emotional Coaching	0.866
Emotional Dismissing	0.870

Reliability test is used to measure whether the distributed questionnaire is reliable or not. From the result, it shows that the Cronbach's alpha for all variables were higher than 0.75 which means that the questionnaire that has been used for this study are acceptable.

### *Inferential Analysis (Logistic Regression)*

Table 4.3: Inferential Analysis (logistic regression)

Variable	P-value	OR	95%Confident Interval (CI)	
			Lower	Upper
<b>Age</b>	<b>0.003</b>	0.879	0.808	0.956
<b>Emotional Coaching</b>	0.338	1.039	0.961	1.124
<b>Emotional Dismissing</b>	0.923	0.995	0.906	1.094

Table 4.3 shows that the relationship between parental age and emotional problem among preschool children was negative. The P-Value of parental age was 0.003 it shows that there is a significant association between parental age with emotional problem among preschool children because the P-Value is lower than 0.05.

This study has not found the relationship between emotion coaching and emotion dismissing with emotional problem among preschool children was not an association. The P-Value of emotional coaching is 0.338 show that no significant value with emotional problem. Furthermore, the emotional dismissing also show that there is no significant value with emotional problem because the P-Value is 0.923. Both of emotional coaching and emotional dismissing are not significant with the emotional problem because the P-Value for each variable was higher than 0.05.



## DISCUSSION AND RECOMMENDATION

Mental health was categorized into two, namely internalizing and externalizing problem. Internalizing problem was an emotional problem include the depression and anxiety meanwhile, externalizing was included of behavior problem. This study aimed to determine the association between parental age with emotional problem among preschool children which is the internalizing problem. Based on finding of this study, prevalence of emotional problem among children were 30.4%. The emotional problem on the previous study was the frequency of behavioural and emotional issues among kids under five ranged from 9.5% to 14.2% (Uğur, Ç., Yürümez, E., and Yilmazer, Y, 2019).

This study found that emotional problems were significantly associated with parental age. In contrast, finding of this study was not parallel with previous study conducted by Zondervan-Zwijenburg et al (2019). In compared with the previous study, the association of parental age with emotional problem had a limited finding. However, the previous study shows that there have an association between parental age with externalizing problem which is behavioral problem (Zondervan-Zwijenburg et al., 2019).

This could be due to different age group, this study targeted preschool whereby previous study targeted primary school children. Different cognitive level and experience in managing emotions also differs based on their age. Moreover, different in culture could also contribute to the differences in the finding. All of parents in this study were Malay, whereas, a previous study targeted in Dutch population.

A part from that, this could be due to different in methodological approaches. In this study, a cross-sectional study design was used, however, previous study conducted using cohort study design. In other word, cohort studies were longitudinal studies which means the researcher collect the data in over time. In addition, this study only dependent on parent's report, however, previous study obtained report from parents, children themselves, and teachers. But because different informants view children in various circumstances, they may not always capture the same notion (Zondervan-Zwijenburg et al., 2019).

Differences in term of study tools could contributed to the differences in the study findings. Questionnaire used in this study was Strength Difficult Questionnaire (SDQ). However, the Achenbach System of Empirically Based Assessment (ASEBA) was used in the previous study. Using different questionnaires will result in different results.

Parental emotional style was divided into two, namely emotion coaching and emotion dismissing. Emotion coaching can be related with parenting style by Diana Baumrind, that is authoritative parent. This is because the emotion coaching was about the parent teach their children in managing the emotion, meanwhile, the emotion dismissing can be related with authoritarian and neglectful parenting style.

Emotion coaching and emotion dismissing in this study showed that there were not found the significant association between emotion coaching and emotion dismissing with emotional problem among preschool children. In contrast, previous study shows that there was a significant association between emotion dismissing and emotional problem (Ab Ghaffar et al., 2023). This could be due to different questionnaire items contributed to the differences in the study findings. The questionnaire Strength and Difficulties Questionnaire (SDQ) was used in this study to measure the children's emotional problem. Based on the Ab Ghaffar et al (2023) studies, Revised Children Anxiety and Depression Scale (RCADS) was used for assessing anxiety.

However, finding of this study was supported by the previous study, stated that there was no significant association between emotion coaching and emotional problem (Ab Ghaffar et al., 2023). Another study's findings that emotion coaching had no direct beneficial effects on children's emotional outcomes. Emotion coaching interacted with emotion dismissing in a way that shielded children from its harmful effects (Lunkenheimer et al., 2007). This might be because parents who use the emotion coaching style of parenting experience less stress. Parents who participated in an emotion coaching parenting course reported much less stress related to parenting (Chan et al., 2021). Previous randomized controlled trial among Chinese mother's preschool children found that parents from intervention group who use emotion coaching in their parenting practices improve usage of emotion coaching parental style and less emotional dismissing after training (Qiu & Shum, 2022).

## **CONCLUSION**

### **RECAPITULATION AND FINDINGS**

The first hypothesis, there is significant association between age and emotional problem among pre-school children. According to the data in Chapter 4, from the table 4.3 (logistic regression) shows the relationship between age and emotional problem among pre-school children was significant which is the P-Value is 0.003. Next, for the second hypothesis which is the association between emotional coaching parental style and emotional problem among pre-school children. According to the data in Chapter 4, from the table 4.3 (logistic regression) was not significant with the P-Value 0.338. As the result, the second hypothesis were answered the research question. The result of third hypothesis proves that the relationship of emotional dismissing parenting style and emotional problem among pre-school children was not significant it is because the P-value for both variable was higher than 0.005. As the result, the third hypothesis were answered the research question.

### **LIMITATION**

The first limitation that we face is lack of sample size. Due to the respondent's unwillingness to provide excellent cooperation in aiding us in acquiring data, this scenario has hindered our study. Next, our research area in the Kelantan district is very limited. Due to this circumstance, we were only able to collect a modest amount of data for our study. Furthermore, purposive sampling is the sampling method we utilize for our investigation. However, it also comes in handy when trying to locate situations with a lot of information or when trying to stretch our limited resources. Research flaws like observer bias are also a serious concern. Last but not least, we discovered that the findings of this study are not unrelated with previous study conducted among primary school. It is because parent's report of children's emotional problems is widely used, however, due to the tendency of parents to underreport internalised emotional symptoms, this methodology may have had an impact on the outcomes.

## **RECOMMENDATION**

The first recommendation for the parents, they get involved in parenting programs primarily for the new parents. Other than that, parents must be a “emotion coach” to their children at their early age. So that, their children may feel comfort to share about their feeling, to react on what they feel and to share about their days. Next, the recommendation for the future study, they can include all of the district in Kelantan so that, they can collect more data. Therefore, future study can be generalized to population in Kelantan. Hence, they can use simple random sampling instead of purposive sampling. It is because, the limitation of purposive sampling in this study was not all sample in the population has equal chance to be involved in this study. Thus, for the future study, it is recommended to collect teacher’s report or children’s report to minimize under reporting on emotional problem in children.

## REFERENCES

- Akter, M., Sadekin, M. N., & Patwary, A. K. (2020). An Empirical Study on Students' Satisfaction from Mawlana Bhashani Science & Technology University, Bangladesh. *Review of Economics and Development Studies*, 6(2), 363-379.
- Alom, S., Patwary, A. K., & Khan, M. M. H. (2019). Factors affecting the turnover intention of Bangladeshi migrants in the United Arab Emirates: An empirical study on the hotel industry. *International Journal of Innovation, Creativity and Change*, 8(3), 344-360.
- Amy Marschall, P. (2022). *Is Anxiety Genetic: verywell mind*. Retrieved from <https://www.verywellmind.com/is-anxiety-genetic-5271575>
- Draisey, J., Halldorsson, B., Cooper, P., & Creswell, C. (2020). Associations between family factors, childhood adversity, negative life events and child anxiety disorders: An exploratory study of diagnostic specificity. *Behavioural and Cognitive Psychotherapy*, 48(3), 253-267.
- Fengmin, Z., Baijun, W., Jiangtao, B., Li, L., & Patwary, A. K. (2022). Investigating revisit intention of medical tourists in China through nutritional knowledge, perceived medical quality, and trust in the physiologist: A recommendation on health tourism policy measures. *Frontiers in Public Health*, 10, 893497.
- Gottman, J. M. (1977). Toward a definition of social isolation in children. *Child Development*, 513-517.
- Havighurst, S. S., Wilson, K. R., Harley, A. E., Kehoe, C., Efron, D., & Prior, M. R. (2013). "Tuning into kids": Reducing young children's behavior problems using an emotion coaching parenting program. *Child Psychiatry & Human Development*, 44, 247-264.
- Hazbar, A. M. H., Alem Mohammed, A., & Karim, A. K. A. (2019). An Empirical Study of Factors Influencing hotel customers' online booking Intention. *مجلة العلوم التربوية و الدراسات الإنسانية*, (5), 1-17.
- Idris, I., Hod, R., Nawi, A. M., Mohd Ghazali, Q., & Anuar, N. A. (2019). The relationship between religiosity and mental health problems among adolescents in Malaysia: a qualitative study. *Mental Health, Religion & Culture*, 22(8), 794-804.
- Li, L., Ragavan, N. A., Patwary, A. K., & Baijun, W. (2022). Measuring patients' satisfaction toward health tourism in Malaysia through hospital environment, nutritional advice, and perceived value: A study on Chinese exchange students. *Frontiers in public health*, 10, 893439.
- Li, L., Wu, B., & Patwary, A. K. (2022). How marine tourism promote financial development in sustainable economy: new evidences from South Asia and implications to future tourism students. *Environmental Science and Pollution Research*, 29, 1155-1172.
- Li, L., Wu, B., & Patwary, A. K. (2022). The psychosocial factors affecting chinese Outbound Exchange and mobility students' academic performance during COVID-19. *Frontiers in psychology*, 13, 872516.
- Manning-Schaffel, Vivian, (2017). "7 Surprising Benefits of Being Older Parent." *NBC News*, NBC News. Retrieved from [www.nbcnews.com/better/health/5-advantages-being-older-parent-ncna775581](http://www.nbcnews.com/better/health/5-advantages-being-older-parent-ncna775581).

- Patwary, A. K., Roy, B., Hoque, R., & Khandakar, M. S. A. (2019). Process of developing a community based tourism and identifying its economic and social impacts: An Empirical study on Cox's Bazar, Bangladesh. *Pakistan Journal of Humanities and Social Sciences*, 7(1), 1-13.
- Porter, R. J. (2020). The biopsychosocial model in mental health. *Australian & New Zealand Journal of Psychiatry*, 54(8), 773-774. <https://doi.org/10.1177/0004867420944464>
- Racine, N., McArthur, B. A., Cooke, J. E., Eirich, R., Zhu, J., & Madigan, S. (2021). Global prevalence of depressive and anxiety symptoms in children and adolescents during COVID-19: a meta-analysis. *JAMA pediatrics*, 175(11), 1142-1150.
- Sahithya, B., & Raman, V. (2021). Parenting style, parental personality, and child temperament in children with anxiety disorders—A clinical study from India. *Indian Journal of Psychological Medicine*, 43(5), 382-391.
- Sahril, Norhafizah, et al. "Factors Associated with Mental Health Problems among Malaysian Children: A Large Population-Based Study." *Children*, vol. 8, no. 2, 1 Feb. 2021, p. 119, [www.mdpi.com/2227-9067/8/2/119](http://www.mdpi.com/2227-9067/8/2/119), <https://doi.org/10.3390/children8020119>. Accessed 18 May 2021.
- Sumethokula, P., Patwary, A. K., Srinuanpanc, B., Srinuanpand, C., Suwandee, P., Thammathikul, A., & Phanong, W. (2020). The potential of new tour repackaging for creative tourism among entrepreneurs in Nakhon Si Thammarat. *International Journal of Innovation, Creativity and Change*, 13(10), 1752-1771.
- Trillingsgaard, T., & Sommer, D. (2018). Associations between older maternal age, use of sanctions, and children's socio-emotional development through 7, 11, and 15 years. *European Journal of Developmental Psychology*, 15(2), 141-155.
- Wang, X., & Cheng, Z. (2020). Cross-sectional studies: strengths, weaknesses, and recommendations. *Chest*, 158(1), S65-S71.
- Wu, B., Liu, S., Wang, J., Tahir, S., & Patwary, A. K. (2021). Assessing the mechanism of energy efficiency and energy poverty alleviation based on environmental regulation policy measures. *Environmental Science and Pollution Research*, 28, 40858-40870.
- Wu, B., Zhai, B., Mu, H., Peng, X., Wang, C., & Patwary, A. K. (2021). Evaluating an economic application of renewable generated hydrogen: A way forward for green economic performance and policy measures. *Environmental Science and Pollution Research*, 1-15.
- Zondervan-Zwijnenburg, M. A., Veldkamp, S. A., Neumann, A., Barzeva, S. A., Nelemans, S. A., van Beijsterveldt, C. E., Branje, S. J., Hillegers, M. H., Meeus, W. H., & Tiemeier, H. (2020). Parental age and offspring childhood mental health: A multi-cohort, population-based investigation. *Child Development*, 91(3), 964-982.

# Factors Influencing the Demand for Halal Foods Purchase Intention in Kelantan

*Audra Suzzy Lee Anak Samuel Law, Nurulizzati Binti Atan, Nur Taqiah Binti Razmi,*

*Siti Aisyah Binti Ramli, Yusuf Adeneye*

*Faculty of Hospitality, Tourism and Wellness, Universiti Malaysia Kelantan*

*Corresponding email: [adeneye.yb@umk.edu.my](mailto:adeneye.yb@umk.edu.my)*

## ABSTRACT

---

This study investigates the factors influencing the demand for Halal foods purchase intention in Kelantan. This study examines how consumers choose halal food based on their intention before purchasing. This study adopts the quantitative method using survey approach through the use of questionnaires (via google form) to collect data from respondents. A total of 210 respondents have been sampled. Findings reveal that the mean value for Halal certification is 4.7229, food quality is 4.6429 and religiosity is 4.7124. The result of the reliability test shows Cronbach's Alpha value for independent variables is 0.909, 0.839, 0.900, and for dependent variables is 0.905. Lastly, Pearson's correlation results show that halal certification, food quality, and religiosity have significant relationships with halal foods purchase intention in Kelantan.

**Keywords: Halal certification, Food Quality, Religiosity, and Halal Foods Purchase Intention**

---

## 1.0 INTRODUCTION

The Halal food industry has recently attracted the attention of several companies from different commodity industries and suppliers. Almost 16% of the total food market consists of Halal food (Dudley, 2013). According to the Global Islamic Economy Report, Muslims spent about US\$1.2 trillion on food and drink worldwide in 2017, and this amount is projected to grow to US\$1 trillion by 2023. Companies have responded to the need for Halal food and beverages (F&B). It shows that in a Muslim-majority country of 18 billion Muslims, there is a sizable and increasingly wealthy Muslim population, who make up about 25% of the world's population. It is because one of the key factors behind the expansion of the Halal food sector is the growing Muslim population.

Halal concept covers a wide range of industries such as tourism, cosmetics, pharmaceuticals, material additives, and detergents, but food consumption is more important to meet the basic needs of consumers. Since Muslim customers need to purchase Halal products, it is important to understand and research their purchasing behaviour. Any act that can be used or performed

according to Islamic law is called Halal. This phrase relates to many aspects of everyday life, not just food and drink. In contrast, "Haram" refers to goods whose manufacture or use violates Islamic law. Allah commands all Muslims and humankind to eat Halal in the Holy Quran. Therefore, the main objective of this study is to identify the variables that influence demand for Halal foods related to purchase intention.

This study addresses three significant problems: food quality, Halal certification, and religiosity. Firstly, foodborne illnesses are rising in Malaysia due to poor food quality. According to Kori (2022) in the New Straits Times, the number of foodborne diseases and reported illnesses, in Malaysia rose 11.8 percent, up to 17,157, in 2019 versus 15,346, in 2015 versus other foodborne illnesses foodborne illness was the most common, with 16,583 cases.

Secondly, Malaysia currently experiences Halal scandals which have called for ensuring Halal certification from Halal authorities. According to Hassan (2021) in the New Strait Times, in Kuala Lumpur, an Islamic agency responsible for Halal certification has come out in the open over a scandal involving spoiled Halal meat and pastries being sold in Halal-certified shops. For example, Malaysians have slammed the Ministry of Islamic Development (JAKIM) for caring more about policing Halal-certified shops than reassuring the public after reports surfaced that a syndicate was selling decades-uncertified meat, including pork, from kangaroos and probable ill horses to be provided as Halal pork with inside the network market.

Finally, Malaysia currently has a religious issue with "Hot Dogs," according to the religious government. BBC News World Asia (2016) urged grocery stores selling hot dogs in Malaysia to change the names of their products threatened with Halal certification. For example, Dogs are considered unclean in Islam, and the name cannot be associated with any Halal certification. Religiosity seems to play a decisive role in purchasing the Intention of the Malays, especially Muslims; their Islamic faith, beliefs, and Life forms are subject to Islamic laws.

Several studies (Sukesti & Budiman, 2014; Sosianika and Amalia, 2020; Purwanto et al., 2020; Purwanto et al., 2021; Abu-Hussin et al., 2017; Pradana et al., 2019; Lee et al., 2016; Yunus et al. 2014 examined the role of Halal certification, e.g., Religiosity regarding Halal food. However, these factors have yet to be studied together in Malaysians' intention to buy Halal food. Sukesti and Budiman (2014) examined religiosity in Halal foods but in an Indonesian context, not Malaysia. Also, these studies should have addressed the role of religiosity Quality as a determinant of Malaysians' intention to buy Halal food. Yunus et al. (2014) studied Islamic food brands, but not as part of Halal certification. In addition, none of these studies considered the role of religiosity

as an indicator of intention to buy Halal food. The study aims to achieve the following research objectives and questions.

### **1.1 Research Objectives**

1. To investigate the relationship between Halal certification and intention to buy Halal foods.
2. To investigate the relationship between food quality and intention to buy Halal foods.
3. To explore the relationship between religiosity and the intention to buy Halal foods.

### **1.2 Research Questions**

- 1 What is the relationship between Halal certification and Halal foods purchase intention?
- 2 What is the relationship between food quality and Halal foods' purchase intention?
- 3 What is the relationship between religiosity and Halal foods' purchase intention?

### **1.3 SIGNIFICANCE OF THE STUDY**

This study will identify the three key variables that influence the demand for Halal food purchase intentions. Halal certification, food quality, and religiosity make up these three elements. Each of these elements is significant in its own right in helping this study arrive at its conclusions.

First and foremost, the relevance of Halal certification. This Halal certification confirms that the restaurants or food facility's Halal certification is guaranteed by JAKIM. JAKIM's approval of the Halal certificate demonstrates this. JAKIM personnel will check the food shop or other sites before verifying the Halal certificate. A customer will confirm that a company's Halal certificate is approved before purchasing Halal food. Therefore, many Muslims are more identified and follow the Halal principle exclusively certified by JAKIM. Muslims are also quite picky about the quality of their cuisine. Knowing that his food is guaranteed clean and safe to eat is crucial for a Muslim. The primary factor in determining food quality is whether a restaurant or food vendor uses Halal-certified ingredients. In Islam, Halal food is not always ensured to be clean, but Haram food is ensured to be unclean for them. Finally, the importance of these factors affecting demand to purchase the intention of Halal food is religiosity. A human being will be more confident with a food seller who shares the same religion as him. This is because they are confident that the cooking



methods and ingredients used by the seller are Halal to eat. So, to gain the trust of someone to purchase the

## **2.0 LITERATURE REVIEW**

### **2.1 Theory of Planned Behavior**

Individual intentions and perceived behavior control strongly influence the Theory of planned behavior (TPB). Ajzen introduced the Theory of Planned Behavior in 1985. Subjective norms, attitudes, and perceived behavior control are the three components. The TPB illustrates how an individual's intention to action will influence an individual in making decisions. TPB considers perceived behavior control over behavior as an actor, influencing choice and purchase behavior. These aspects are not necessarily actively or consciously examined during decision-making, but they serve as the backdrop. This theory focuses on factors of individual behavior that influence purchase decisions. This notion broadens our understanding of Halal foods and helps us make the best option while selecting Halal foods.

Additionally, TPB shows that customer perception influences their intention to purchase Halal food. According to Y.A. Aziz and Chok (2013), Halal covers an extensive variety of considerations such as Halal awareness and Halal certification. According to Alam and Mohamed (2011), buying Halal items has a positive orientation and connection. According to Ajzen (1991), attitude is defined as an important component in forecasting and clarifying people's actions to purchase Halal items. Customers have a positive attitude because they are more motivated to want to buy Halal foods. As a result, attitude is seen as an important component in influencing customers' intentions to purchase Halal foods.

Furthermore, this TPB can provide an in-depth understanding of subjective norms, attitudes, and behavioural control influencing an individual's decision-making purpose. This is because intention is the most essential concept in Islam. Muslims must select food that is believed to be Halal. Positive intentions and attitudes will encourage users to make better decisions. As a result, Muslims must have solid knowledge in choosing Halal food before buying it so that there are no doubts and misgivings about the food.

### **2.2 Research Hypotheses**

The hypothesis for this research is to see if there are many significant relationships between the independent variables (Halal certification, food quality, and religiosity) and dependent variables (Halal foods' purchase intention).

### **2.2.1 Relationship Between Halal Certification and Halal Foods' Purchase Intention**

Ahmadova and Aliyev (2020) investigated customer attitudes regarding Halal cuisine in Azerbaijan and determined the primary elements influencing these sentiments. The authors interviewed 636 native Muslims using the idea of planned behaviour and the random sample technique. The authors discovered, using a rigorous least square's technique, that the accessibility of the Halal concept and health factors impact opinions toward Halal cuisine. The accessibility of Halal certification and customer attitudes toward health are financially and statistically significant. Purwanto and Sudargini (2021) investigate the relationships between Halal certificate purchasing. Provide Halal food products. To reach the research goal, the authors utilized a quantitative and distributed survey questionnaire to 120 Halal food customers in Indonesia. The data were analyzed with PL Sand, which included the Smart PLS program software version as the technique. Purwanto and Sudargini (2021) discovered that Halal certification affects customer intentions to purchase Halal food, which increases consumer interest in purchasing Halal food products.

Herindar (2022) analysed the influence of Halal certification and knowledge on consumers' decisions to purchase Halal food as an influencing factor. This research also describes Maqshid Syariah regarding Halal food items about five fundamental Maqshid Shariah principles and their requirements. Through targeted sampling, the authors collected data from 151 respondents (Generation Z) and utilized route analysis to examine it. According to Herindar (2022), Halal certification significantly and favourably influenced consumers' interest in and choices in purchasing Halal cuisine. This was also discovered by the author. Sharia requires Maqasid Shariah Halal food to be consumed according to five main aspects: hifdzud din (preserve religion), hifdzun-nafs (defend soul), handful-all (protect mind), hidden nasal (obtaining offspring), and handful mal (preservation of the estate), as well as necessary to consider the level of human needs, dharuriyyat (immediate needs), hajiyat (secondary requirements) (tertiary markets).

**Hypothesis 1: There is a positive relationship between Halal certification and Halal foods' purchase intention.**

### **2.2.2 Relationship Between Food Quality and Halal Foods' Purchase Intention**

Hosseini et al. (2020) investigate if the quality of food influences Muslim customers to pay more for Halal-certified food. The authors used a questionnaire for polling 272 Muslim customers in Malaysia. The partial least squares approach was used to analyse the data. The authors discovered that meal quality influenced Muslim customers' willingness to pay more for Halal cuisine. The authors believe that the importance of religious affiliation in purchase behaviour is essential in determining who to target and how to build a successful marketing mix approach.

Purwanto et al. (2021) studied and investigated the effect of perception, quality, safety, and awareness of Halal food on the purchase intentions of student customers. The writers employed the combined sequential explanation approach and the model of structural equations (SEM). Using snowball sampling procedures, the authors randomly recruited 350 questioned students via an online interactive questionnaire. Purwanto and co. (2021). He discovered that the standard of Halal cuisine substantially influenced purchasing. The authors offered data for Halal food producers to consider student customers as part of their targeted consumers in the Islamic food, business and to assist in identifying students' degrees of Halal awareness and views on food.

Wang et al. (2020) examined the connection between environmental consciousness and purchase intention for organic food, with assessed food quality and price sensitivity acting as moderators. The authors provide new information on consumer perceptions and behavioural preferences about organic food. Wang et al. (2020) showed, collecting survey data from 518 customers at various grocery shops in China, that perceived food quality had a mediation influence on the link between environmental consciousness and the desire to buy organic food.

**Hypothesis 2: There is a positive relationship between food quality and Halal foods' purchase intention.**

### **2.2.3 Relationship Between Religiosity and Halal Foods' Purchase Intention**

Ahmadova and Aliyev (2020) investigated customer attitudes regarding Halal cuisine in Azerbaijan and determined the primary elements influencing these sentiments. The authors surveyed 636 native Muslims using the idea of planned behaviour and the random sample approach. Using a rigorous least square's technique, the authors discovered that the accessibility of Halal standards and health factors impact opinions toward Halal cuisine. The accessibility of Halal certification and customer attitudes toward health are financially and statistically significant. Purwanto and Sudargini (2021) investigated the relationship between Halal certificate purchases. Do you sell halal products? To reach the research goal, the authors utilised a quantitative technique, providing questionnaires to 120 Halal certification customers in Indonesia.

The gathered data was analysed with PL Sand, powered by version 3 of the Smart PLS software.0. According to Purwanto and Sudargini (2021), Halal certification affects the desire to purchase Halal food and boosts customer interest in purchasing Halal food. Herindar (2022) investigated the influence of Halal knowledge and standards on Halal food purchase decisions as an intervening variable. Furthermore, this research covers the Maqshid Sharia on Halal products and the five essential concepts of Maqshid Sharia and their requirements. The authors employed route analysis to examine data gathered by targeted sampling from 151 respondents (Generation Z). Halal certification has a good and considerable influence on Halal certification purchasing preferences and decisions, according to Herindar (2022). The author also found this. hifdz al-nafs (defend soul), handful-everything (protect mind), concealed nasal (getting offspring), and a handful of times (property preservation), and considering the degree of human necessities Dharuriyyat (urgent requirements), Hajiyat (secondary needs), and tahsiniyat (long-term needs) (tertiary needs). Hosseini et al. (2020) investigated Muslim customers' willingness to pay for halal-certified food. The authors gathered information from a survey of 272 Muslim customers in Malaysia. The appropriate statistical approach was used to analyse the data. The scientists discovered that religious affiliation influences the decision to pay for halal meals. Religious commitment affects the association between storage and transportation and the willingness to purchase halal-certified food beneficially.

Ahmadova and Aliyev (2020) surveyed local Muslims' religious beliefs and opinions about halal cuisine using questionnaires. The authors discovered that the intensity of the link between religiosity and attitude toward halal cuisine is affected by religiosity and other characteristics, including age, gender, status, and the availability of Halal certification. As a predominantly Muslim region, researching attitudes toward halal products in Azerbaijan can be a valuable source of data when working to develop a ping shariah law, branding tactic in this market, i.e., vital observations from this research will guide businesses in adjusting their marketing plan to efficiently target this market (Ahmadova & Aliyev, 2020).

Hanafiah and Hamdan (2020) investigated the influence of religion on Muslim travelers' views and consumption behaviour toward Halal cuisine when visiting non-Muslim countries. Survey. Hanafiah and Hamdan (2020) analysed the gathered data using the partial least squares model of structural equations. The authors discovered that Muslim tourists' opinions about Halal consumption were substantially influenced by their level of beliefs, subjective standards, and perceived control behaviour. The authors emphasise the importance of non-Muslim vacation destination marketers adjusting their marketing techniques and considering promoting Islamic dietary requirements when developing trip packages.

Sudarsono and Nugrohowati (2020) investigated the influence of religion, knowledge, and attitudes on Indonesian consumers' intent to use halal foods, cosmetics, and medicines. Using a quantitative method, the authors employed online questionnaires to gather information from 684 respondents from 27 Indonesian provinces. Sudarsono and Nugrohowati (2020) discovered that religion impacted customers' intentions to purchase halal food, cosmetics, and medications. The survey also found that religion, rather than cosmetics and medicines, had a more significant effect on customers' intention to purchase halal food than beliefs and attitudes.

**Hypothesis 3: There is a positive relationship between religiosity and Halal food purchase intention.**

### 2.3 Research Framework

The conceptual framework was created to explain the variables that impact the purchase intention to demand Halal food. Figure 1 illustrates the conceptual framework that the researcher has proposed. Proposed independent variables include Halal certification, food quality, and religiosity. The dependent variable is the factor that affects the purchase intention to demand Halal foods. An individual chooses to buy food based on various food categories and item classification as Halal. The preferred option will be Halal certified food. They must take Halal food because of them Muslims should choose Halal food through approved Halal symbols, slaughter methods that comply with Islamic law, and food components. Awan, Siddiqui, and Haider (2014) pointed out that to show that their cuisine complies Sharia rules, Halal restaurants are required to display a Halal certificate mark.

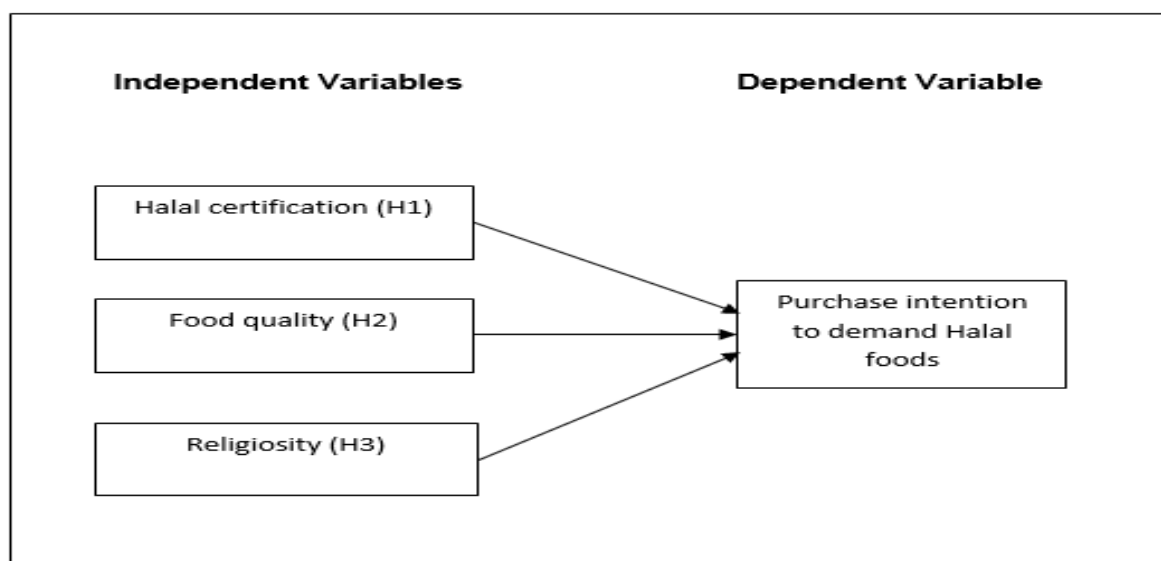

**Figure 1: Conceptual framework of the study**

### **3.0 METHODOLOGY**

#### **3.1 Research Design**

The plan that describes the study methodology and data-gathering strategies include research design. A research design is a study project plan that explains how researchers will test hypotheses or achieve their study objectives (McDaniel & Gates, 1990). It serves as the foundation for our study. In this investigation, quantitative methodologies will be applied. Consequently, the sample will be analyzed by selecting a location sample that includes all Muslim clients. Muslim customers will select a representative to provide input on variables impacting the purchase intention of Halal cuisine. In the descriptive research, the questionnaire will be utilized as a reference source. The questionnaire will be designed to capture all of the necessary data for the research.

#### **3.2 Data Collection**

There are two types of basic data collection methods which are primary data and secondary data. Primary data is records gathered thru surveys, Interviews, or experiments, at the same time as secondary records are data associated with reference works which include newspapers, books, and the Internet. The Secondary Data is collected based on existing information.

In this study, we selected the primary data because we obtained data through a survey by sending a questionnaire to all Muslim clients and students at the University of Malaysia Kelantan (UMK) on factors influencing the demand Halal foods Purchase intention. The questionnaire was created using Google Forms. This questionnaire was used to gather information related to the factors influencing the demand Halal foods purchase intention.

#### **3.3 Research Instrument**

The research instrument includes surveys, questionnaires, telephone, and interviews. This study employs a questionnaire as the research instrument. An objective technique for collecting data about people's knowledge, beliefs, attitudes, and behavior is through the use of questionnaires (Boynton & Greenhalgh, 2004). The questionnaire of the study has three sections. The first section introduces the cover letter. The second section introduces the demographic information, and the third section presents the variable items. Variable items in the halal certification were sourced from Ahmadova and Aliyev (2020). Variable items on food quality were sourced from Iranmanesh et al. (2019). Variable items on religiosity were sourced from Ahmadova and Aliyev (2020) while variable items on halal food purchase intention were sourced from Pradana et al. (2020). The questionnaire items are shown in Table 1.

**Table 1**  
**Variables and measurement items**

<b>Items to measure Halal certification</b>	<b>SD</b>	<b>D</b>	<b>UN</b>	<b>A</b>	<b>SA</b>
1. I always pay attention to the availability of Halal certificates. 2. The availability of a Halal certificate is important for me. 3. I always try to buy Halal-certified products. 4. The availability of a Halal certificate is an indicator of the product being Halal. 5. I choose Halal products based on the Halal logo on the product.					
<b>Items to measure food quality</b>	<b>SD</b>	<b>D</b>	<b>UN</b>	<b>A</b>	<b>SA</b>
1. I take foods that contain high-quality ingredients. 2. I take foods that contain no Haram ingredients. 3. I take foods that contain ingredients that are free from any forbidden or dirty components.					
<b>Items to measure religiosity</b>	<b>SD</b>	<b>D</b>	<b>UN</b>	<b>A</b>	<b>SA</b>
1. I believe in the fundamental principles of Islam. 2. I pray Namaz five times a day. 3. I fast during Ramadan. 4. I adhere to religious rules. 5. I always try to increase my religious knowledge.					
<b>Items to measure Halal foods purchase intention</b>	<b>SD</b>	<b>D</b>	<b>UN</b>	<b>A</b>	<b>SA</b>
1. I prefer to buy a “Halal” certified product even when the brand is not very popular. 2. I would recommend my family and friends buy Halal food. 3. I am interested in buying Halal food. 4. I will keep buying Halal food according to my needs.					

### **3.4 Sampling**

#### **3.4.1 Sampling Technique**

Sampling can be performed using two methods: probabilistic and non-probabilistic sampling (Saunders, Lewis, & Thornhill, 2012). This is because non-probability sampling is not based on the probability that a population member is selected in the sample, and therefore no statistical inferences can be made about the sample. On the other hand, probabilistic sampling was performed based on the assumption that each population member has a finite probability of being included in the sample. A targeted sampling method is used to collect respondents from Muslim customers in Halal restaurants in Kelantan. Given that the total number of Muslim customers in Halal restaurants in Kelantan (Amanda restaurant, The H restaurant, Nasi Kukus Luqman restaurant, D'mee restaurant, and Syikin nasi ayam) is unknown. The study will use a non-probability sampling technique. The researchers will visit the Halal restaurants and sample some Muslim customers who would be voluntarily participating in the study.

#### **3.4.2 Sample Size**

A sample is a smaller and more manageable element than a larger group. A sample is a subset that represents the size of the entire population. Sample members are known as subjects, whereas the number of subjects in the sample is known as sample size. Usually, a sample size can be determined by the population because when the number of the population increases, the simple size will also increase. The sample size can be determined by 10 times the number of predictors or independent variables (Hair et al., 2019).

In this study, researchers intend to choose 211 respondents in total from Muslim customers on purchase intention of halal foods in Malaysia as the sample size. This sample size is greater than 30 respondents and less than 500 respondents. The best sample size for quantitative investigations, according to Sekaran and Bougie (2016), is between 30 and 500 participants.

The sample size chosen by the researcher is very appropriate and sufficient because the Muslim customers in Malaysia is large, necessitating a smaller sample size for this study. Thus, a sample size of 250 can determine the accuracy and effectiveness of the sample size, increasing confidence that it will comprehensively address the existing gap.

### **3.5 Data Analysis**

Data analysis is an evaluation approach wherein information sets are evaluated using statistical, logical, and analytical methods. Statistical Package Social Science (SPSS) is the tool or software used to analyze the data. SPSS software is helpful for the researcher to determine an excellent



statistical technique. Statistical data such as cumulative and valid percentages are explained by the SPSS data. The researchers will use SPSS version 26.0 to create data entry and analysis tables. Researchers can collect data for variable items as well as perform descriptive and correlation evaluations.

### **3.5.1 Descriptive Analysis**

Descriptive analyses help with this. Distribute data and allow associations between variables to be identified to organize further statistical analysis. Descriptive statistics are used to analyze data from Percentage and frequency and with central trend measures such as Mean, mode, and median.

### **3.5.2 Correlation Test**

This research can also be defined as correlation Research. According to Gay et al. (2011), correlation research describes an existing condition if it deviates significantly from it. Conditions typically described in surveys or observational studies. Data is collected to decide whether there is a quantitative relationship between measurable variables. The correlation study provides a numerical estimate of the connection between two variables. Correlation Analysis is required to discover the connection among the variables. Correlation analysis is a statistical approach that aims to determine the Degree of correlation among variables. Hence this study performs a correlation analysis to decide the correlation between Halal certification, meal quality, religiosity, and buying intention to request Halal food.

## **4.0 FINDINGS**

This study discusses the results of the data analysis that was done on the data obtained from the survey. The study collected 210 respondents out of 250 distributed, giving a response rate of 84%. The data were analyzed to examine and identify the factors influencing the demand for halal foods purchase intention. Besides that, the researchers were able to test the hypothesis and answer the research objective of this study.

### **4.1 Demographic Profile**

Based on table 2, shows the data analysis from 210 respondents. The demographic profile includes gender, age group, marital status, race religion, and educational background.

The result shows that most of the respondents are female with 121 respondents. Followed by the age group, most respondents are from 18 to 25 years old with 146 respondents. This show that the

young generation is the most respondents that purchase Halal foods. Next, the most of respondents that purchase Halal foods are single with 160 respondents out of 210 respondents. Most of the respondents are Malay with 176 respondents, meaning that most of the respondents are Muslim with 187 respondents. For the education background, most of them are Bachelor's Degree holders with 100 respondents out of 210 respondents. From the data, we can conclude that most of the respondents are Muslim and as we know, as Muslims, they must choose Halal foods according to Islamic law. Therefore, Muslim have solid knowledge about Halal foods and make wise decisions before buying them so that there is no doubt about foods.

**Table 2**  
**Demographic Profile**

<b>Profile</b>		<b>Frequency</b>	<b>Percentage</b>
Gender	Female	121	57.6
	Male	89	42.4
Age Group	18 – 25	146	69.5
	26 – 35	39	18.6
	36 – 45	13	6.2
	46 – 55	7	3.3
	55 and above	5	2.4
Marital status	Married	50	23.8
	Single	160	76.2
Race	Chinese	1	0.5
	Indian	5	2.4
	Malay	176	83.8
	Others	28	13.3
Religion	Islam	187	89.0
	Hindu	4	1.9
	Others	19	9.0
Education Background	Secondary School	65	31.0
	Diploma	41	19.5
	Bachelor Degree	100	47.6
	Postgraduate Degree	4	1.9

#### **4.2 Descriptive Statistics**

Based on table 3 shows the total mean score and standard deviation of the variables for the independent variables which are halal certification, food quality, and religiosity, while the dependent variable represents

the purchase intention to demand Halal foods. For the independent variables, the total mean score and the highest standard deviation are Halal certification (mean= 4.7229, SD= 0.57537) followed by religiosity (mean= 4.7124, SD= 0.59305) and food quality has the lowest score (mean= 4.6429, SD = 0.66744). For the dependent variable, purchase intention to demand Halal foods has a score (mean= 4.7044, SD= 0.58926). In conclusion, Halal certification most influences the purchase intention to demand Halal foods in Kelantan, Malaysia.

**Table 3**

**Total Mean Score and Standard Deviation of Variables**

Variable	N	Minimum	Maximum	Mean	Standard Deviation
Halal Certification	210	1.00	5.00	4.7229	0.57537
Food Quality	210	1.00	5.00	4.6429	0.66744
Religiosity	210	1.00	5.00	4.7124	0.59305
Halal Foods Purchase Intention	210	1.00	5.00	4.7044	0.58926

### 4.3 Reliability Test

The overall Cronbach's Alpha Coefficient for the study's survey variables. Based on table 4 shows the total of three independent variables and the first variable is halal certification, this variable has a total of 5 items with Cronbach's value is 0.909. The second variable is food quality with 3 items used to test reliability. The value is 0.842. The third independent variable is 0.903 for religiosity with 5 items under it. The dependent variable which is purchase intention is 0.909 with 4 items under it and it is considered as good terms of internal consistency. For this study, the items for independent variables and dependent variables are reliable.

**Table 4**

**Reliability Test (Cronbach's Alpha)**

Variables	Cronbach's Alpha	Number of items
-----------	------------------	-----------------

Halal Certification	0.909	5
Food Quality	0.842	3
Religiosity	0.903	5
Purchase Intention	0.909	4

#### 4.4 Pearson Correlation Result

Based on table 5 shows the correlation analysis for three hypotheses (Halal certification, food quality, and religiosity). Hypothesis 1 shows the relationship between halal certification and halal foods purchase intention, The correlation coefficient of 0.807 suggested a strong positive relationship between halal certification and halal foods purchase intention. The p-value of purchase intention is 0.000 which is less than the highly significant level of 0.001. Therefore, there is a significant relationship between halal certification and purchase intention.

Hypothesis 2 shows the relationship between foods quality and halal foods purchase intention. The correlation coefficient of 0.782 suggested a strong positive relationship between food quality and halal foods purchase intention. The p-value of halal food purchase intention is 0.000 which is less than the highly significant level of 0.001. Therefore, there is a significant relationship between food quality and halal foods purchase intention.

Hypothesis 3 shows the relationships between religion and halal foods purchase intention. The correlation coefficient of 0.730 suggested a strong positive relationship between religiosity and halal foods purchase intention. The p-value of halal food purchase intention is 0.000 which is less than the highly significant level of 0.001. Therefore, there is a significant relationship between religiosity and halal foods purchase intention.

**Table 5**  
**Pearson Correlation**

Variables	Halal Certification	Purchase Intention
Halal Certification	1	0.807 (p-value= 0.000)
Purchase Intention	0.807*** (p-value = 0.000)	1
Variables	Food Quality	Purchase Intention

Food Quality	1	0.782 (p-value= 0.000)
Purchase Intention	0.782*** (p-value= 0.000)	1
Variables	Religiosity	Purchase Intention
Religiosity	1	0.782 (p-value= 0.000)
Purchase Intention	0.730*** (p-value= 0.000)	1

---

## 5.0 DISCUSSION AND RECOMMENDATION

### 5.1 Hypothesis 1

The result for hypothesis 1 shows that halal certification significantly and has a positive influence on halal foods purchase intention. This result is due to the following reason.

#### (i) Availability of halal certification

Availability of halal certification

Halal-certified foods not only benefit Muslims but also everyone because of their Wholesomeness (Thoyyiban).

#### (ii) Display of halal certification

Halal certification at restaurants ensures that foods are served according to Islamic dietary laws. Halal means permitted or lawful or fit for consumption

#### (iii) Halal logo

The halal logo is the most common graphic mark used for Halal Malaysia which is a symbol to indicate the product or business is certified Halal by JAKIM. This is also an indication that the product or business is Shariah compliance.

### 5.2 Hypothesis 2

The results for hypothesis 2 show that food quality significantly and has positive influence on halal foods purchase intention. This result is due to the following reason.

#### (i) Providing the nutrition of food

A healthy diet is essential for good health and nutrition

(ii) Providing high-quality ingredients

Quality ingredients can have a true impact on the taste of food that is served at a restaurant.

### **5.3 Hypothesis 3**

The results for hypothesis 3 show that religiosity significantly and has a positive influence on halal foods purchase intention. This result is due to the following reason.

(i) Principles of Islam

The concept of halal cuisine encompasses the food's religious conformity and its cleanliness, sanitary quality, and acceptability in terms of human values.

(ii) Religious Knowledge

Consuming Halal is an order of Allah and an essential part of the Islamic faith.

### **5.4 RECOMMENDATION**

This study's findings can be used as an ongoing framework to enhance more optimal findings on halal food in Malaysia, especially for those who are directly involved in buying behavior of halal food.

First, the recommendation that can be done to increase halal food purchase intention is to put the halal logo on the main signboard of the shop, so that the people will trust and see that the store has halal food and items. A store can also put the name of the store with Islamic and halal elements. This is because a person's first impression lies in his first glance at the name of the store (signboard). This will influence a person in halal food purchase intention.

Next, the influence of packaging and labeling is very important to investigate the influence of packaging design, labeling practices, and product information on consumer perception and intention to purchase halal food. This is to assess the impact of clear and accurate labeling on building consumer, trust and confidence in halal food products.

### **6.0 CONCLUSION**

In conclusion, this study examines the factors influencing the demand for Halal foods purchase intention in Kelantan. A total of 210 respondents were sampled and found that the mean value for Halal certification is 4.7229, food quality is 4.6429 and religiosity is 4.7124. Cronbach's Alpha value for independent variables is 0.882 and Pearson's correlation results show that halal certification, food quality, and religiosity have significant relationships with halal foods purchase intention.

## REFERENCES

- Abdullah, J. B., Abdullah, F., & Bujang, S. B. (2021). Is there a need for an improved religiosity measurement tailored to consumer research? *International Journal of Academic Research in Economics and Management Sciences*, 10(1). <https://doi.org/10.6007/ijarems/v10-i1/9550>
- Abou-Youssef, M., Kortam, W., Abou-Aish, E., & El-Bassiouny, N. (2011). Measuring Islamic-driven buyer behavioral implications: A proposed market-minded religiosity scale. *Journal of American Science*, 7(8), 728-741.
- Abu-Hussin, M. F., Johari, F., Hehsan, A., & Mohd Nawawi, M. S. A. B. (2017). Halal purchase intention among the Singaporean Muslim minority. *Journal of Food Products Marketing*, 23(7), 769-782.
- Ahmadova, E., & Aliyev, K. (2020). Determinants of attitudes towards halal products: Empirical evidence from Azerbaijan. *Journal of Islamic Marketing*.
- Ahmed, A. (2008). Marketing of halal meat in the United Kingdom: Supermarkets versus local shops. *British Food Journal*.
- Akter, M., Sadekin, M. N., & Patwary, A. K. (2020). An Empirical Study on Students' Satisfaction from Mawlana Bhashani Science & Technology University, Bangladesh. *Review of Economics and Development Studies*, 6(2), 363-379.
- Alom, S., Patwary, A. K., & Khan, M. M. H. (2019). Factors affecting the turnover intention of Bangladeshi migrants in the United Arab Emirates: An empirical study on the hotel industry. *International Journal of Innovation, Creativity and Change*, 8(3), 344-360.
- Aneesh, A., & Khadar, A. (2022). Halal Food Industry in World: Opportunity and Challenges. Available at SSRN 4153508.
- Auto, H. (2021, January 02). Halal meat scandal: Malaysian authorities slammed for perceived inaction. *The Straits Times*. Retrieved from <https://www.straitstimes.com/asia/se-asia/halal-meat-scandal-malaysian-authorities-slammed-for-perceived-inaction>
- Awan, H. M., Siddiquei, A. N., & Haider, Z. (2015). Factors affecting Halal purchase intention—evidence from Pakistan's Halal food sector. *Management Research Review*, 38(6), 640-660.
- Aziz, Y. A., & Chok, N. V. (2013). The role of Halal awareness, Halal certification, and marketing components in determining Halal purchase intention among non-Muslims in Malaysia: A structural equation modeling approach. *Journal of International Food & Agribusiness Marketing*, 25(1), 1-23.
- BBC News World Asia (2016) Hot dogs 'must be renamed' in Malaysia, says religious government body. BBC New Services. Retrieved from <https://www.bbc.com/news/world-asia-37700495>
- Bonne, K., & Verbeke, W. (2008). Religious values inform halal meat production and the control and delivery of halal credence quality. *Agriculture and Human values*, 25(1), 35-47.
- Borzooei, M., & Asgari, M. (2013). The Halal brand personality and its effect on purchase intention. *Interdisciplinary Journal of Contemporary Research in Business*, 5(3), 481-491.
- Boynton, P. M., & Greenhalgh, T. (2004). Selecting, designing, and developing your questionnaire. *Bmj*, 328(7451), 1312-1315.
- Dudley, D. (2013). Halal market sees rapid growth. *Meed: Middle East Economic Digest*, 57(45), 24.

- Essoo, N., & Dibb, S. (2004). Religious influences on shopping behaviour: An exploratory study. *Journal of marketing management*, 20(7-8), 683-712.
- Fengmin, Z., Baijun, W., Jiangtao, B., Li, L., & Patwary, A. K. (2022). Investigating revisit intention of medical tourists in China through nutritional knowledge, perceived medical quality, and trust in the physiologist: A recommendation on health tourism policy measures. *Frontiers in Public Health*, 10, 893497.
- Froehle, B. T. (1994). Religious competition, community building, and democracy in Latin America: grassroots religious organizations in Venezuela. *Sociology of religion*, 55(2), 145-162.
- Gay, L. R., Mills, G. E., & Airasian, P. W. (2011). *Educational research: Competencies for analysis and applications*: Pearson Higher Ed.
- Golnaz, R., Zainalabidin, M., Mad Nasir, S., & Eddie Chiew, F. C. (2010). Non-Muslims' awareness of Halal principles and related food products in Malaysia. *International food research journal*, 17(3), 667-674.
- Hanafiah, M. H., & Hamdan, N. A. A. (2020). Determinants of Muslim travellers Halal food consumption attitude and behavioural intentions. *Journal of Islamic Marketing*, 12(6), 1197-1218.
- Hanzaee, K. H., & Sadeghian, M. (2014). The impact of corporate social responsibility on customer satisfaction and corporate reputation in automotive industry: Evidence from Iran. *Journal of Islamic Marketing*.
- Hassan, H. (2021). Halal meat scandal: Malaysian authorities slammed for perceived inaction. <https://www.straitstimes.com/asia/se-asia/halal-meat-scandal-malaysian-authorities-slammed-for-perceived-inaction>.
- Hayati, T.A., Habibah, M.A., Anuar, K. and Jamaludin, K.R. (2008), "Quality assurance in halal food manufacturing in Malaysia: a preliminary study", Proceedings of International Conference on Mechanical & Manufacturing Engineering (ICME2008), 21-23 May 2008, Johor Bahru, Malaysia.
- Hazbar, A. M. H., Alem Mohammed, A., & Karim, A. K. A. (2019). An Empirical Study of Factors Influencing hotel customers' online booking Intention. *مجلة العلوم التربوية و الدراسات الإنسانية*, (5), 1-17.
- Herindar, E. (2022). The Maqoshid Sharia and the importance of consuming halal food products for Z Muslim Generation: halal food and product. *Halal Research Journal*, 2(2), 77-95.
- Hosein, N. Z. (2012). Measuring the purchase intention of visitors to the auto show. *Journal of Management & Marketing Research*, 9(1), 1-17.
- Hosseini, S. M. P., Mirzaei, M., & Iranmanesh, M. (2019). Determinants of Muslims' willingness to pay for halal certified food: does religious commitment act as a moderator in the relationships? *Journal of Islamic Marketing*.
- Iranmanesh, M., Mirzaei, M., Hosseini, S. M. P., & Zailani, S. (2019). Muslims' willingness to pay for certified halal food: an extension of the theory of planned behaviour. *Journal of Islamic Marketing*.
- Jannah, S. M., & Al-Banna, H. (2021). Halal awareness and halal traceability: Muslim consumers' and entrepreneurs' perspectives. *Journal of Islamic Monetary Economics and Finance*, 7(2), 285-316.
- Kori, G (2022). Stringent monitoring ensures food safety, quality. <https://www.nst.com.my/opinion/letters/2022/06/801817/stringent-monitoring-ensures-food-safety-quality>
- Lee, S. H., Siong, K. C., Lee, K. S., & Kim, H. S. (2016). Non-muslim customers' purchase intention on halal food products in malaysia. *Culinary science and hospitality research*, 22(1), 108-116.
- Li, L., Ragavan, N. A., Patwary, A. K., & Baijun, W. (2022). Measuring patients' satisfaction toward health tourism in Malaysia through hospital environment, nutritional advice, and



perceived value: A study on Chinese exchange students. *Frontiers in public health*, 10, 893439.

- Li, L., Wu, B., & Patwary, A. K. (2022). How marine tourism promote financial development in sustainable economy: new evidences from South Asia and implications to future tourism students. *Environmental Science and Pollution Research*, 29, 1155-1172.
- Li, L., Wu, B., & Patwary, A. K. (2022). The psychosocial factors affecting chinese Outbound Exchange and mobility students' academic performance during COVID-19. *Frontiers in psychology*, 13, 872516.
- Masnono, A. (2005). Factors influencing the Muslim consumer's level of confidence on halal logo issued by JAKIM: An empirical study. *Unpublished Master's thesis*. University Saints Malaysia.
- McDaniel, S. W., & Burnett, J. J. (1990). Consumer religiosity and retail store evaluative criteria. *Journal of the Academy of marketing Science*, 18(2), 101-112.
- Mukhtar, A., & Butt, M. M. (2012). Intention to choose Halal products: the role of religiosity. *Journal of Islamic marketing*.
- Patwary, A. K., Roy, B., Hoque, R., & Khandakar, M. S. A. (2019). Process of developing a community based tourism and identifying its economic and social impacts: An Empirical study on Cox's Bazar, Bangladesh. *Pakistan Journal of Humanities and Social Sciences*, 7(1), 1-13.
- Pradana, M., Syarifuddin, S., Hafid, H., Gilang, A., & Diandri, M. (2019). Purchase intention determinants of halal food in secular countries. *International Journal of Supply Chain Management*, 8(4), 83-89.
- Pradana, M., Wardhana, A., Rubiyanti, N., Syahputra, S., & Utami, D. G. (2020). Halal food purchase intention of Muslim students in Spain: testing the moderating effect of need-for-cognition. *Journal of Islamic Marketing*.
- Pramintasari, T. R., & Fatmawati, I. (2017). Pengaruh Keyakinan Religius, Peran Sertifikasi Halal, Paparan Informasi, dan Alasan Kesehatan Terhadap Kesadaran Masyarakat Pada Produk Makanan Halal. *Jurnal Manajemen Bisnis*, 8(1), 1-33.
- Purwanto, A., & Sudargini, Y. (2021). Exploring factors affecting the purchase intention of halal food products: an empirical study on student consumers. *International Journal of Social and Management Studies*, 2(4), 13-21.
- Purwanto, A., Ardiyanto, J., & Sudargini, Y. (2021b). Intention Factors of Halal Food Purchase among Student Consumers: An Explanatory Sequential Mixed Methods Study. *Journal of Industrial Engineering & Management Research*, 2(2), 21-34.
- Purwanto, A., Haque, M. G., Sunarsi, D., & Asbari, M. (2021). The Role of Brand Image, Food Safety, Awareness, Certification on Halal Food Purchase Intention: An Empirical Study on Indonesian Consumers. *Journal of Industrial Engineering & Management Research*, 2(3), 42-52.
- Purwanto, H., Fauzi, M., Wijayanti, R., Al Awwaly, K. U., Jayanto, I., Purwanto, A., ... & Hartuti, E. T. K. (2020). Developing model of halal food purchase intention among indonesian non-muslim consumers: an explanatory sequential mixed methods research. *Systematic Reviews in Pharmacy*, 11(10), 396-407.
- Rahim, N. A., & Junos, S. (2012). The halal product acceptance model for the religious society. *Business and Management Quarterly Review*, 3(1), 17-25.
- Regenstein, J. M., Chaudry, M. M., & Regenstein, C. E. (2003). The kosher and halal food laws. *Comprehensive reviews in food science and food safety*, 2(3), 111-127.
- Riaz, M. N., & Chaudry, M. M. (2003). *Halal food production*. CRC press.
- Saunders, M., Lewis, P., & Thornhill, A. (2012). Research methods for business students. 6. uud. painos.

- Schneider, H., Krieger, J., & Bayraktar, A. (2011). The impact of intrinsic religiosity on consumers' ethical beliefs: Does it depend on the type of religion? A comparison of Christian and Moslem consumers in Germany and Turkey. *Journal of Business Ethics*, 102(2), 319-332.
- Shafie, S., & Othman, M. N. (2006, September). Halal certification: an international marketing issues and challenges. In *Proceeding at the International IFSAM VIIIth World Congress* (Vol. 28, p. 30). Kuala Lumpur: University of Malaya Press.
- Söderlund, M. (2006). Measuring customer loyalty with multi-item scales: A case for caution. *International Journal of Service Industry Management*.
- Sosianika, A., & Amalia, F. A. (2020). Uncovering Indonesian Millennial's Halal Food Purchase Intention: Halal Value and Halal Logo as the Antecedents. *International Journal of Applied Business Research*, 31-45.
- Sudarsono, H., & Nugrohowati, R. N. I. (2020). Determinants of the intention to consume halal food, cosmetics and pharmaceutical products. *The Journal of Asian Finance, Economics and Business*, 7(10), 831-841.
- Sukesti, F., & Budiman, M. (2014). The influence halal label and personal religiosity on purchase decision on food products in Indonesia. *International Journal of Business, Economics and Law*, 4(1), 150-153.
- Sumethokula, P., Patwary, A. K., Srinuanpanc, B., Srinuanpand, C., Suwandee, P., Thammathikul, A., & Phanong, W. (2020). The potential of new tour repackaging for creative tourism among entrepreneurs in Nakhon Si Thammarat. *International Journal of Innovation, Creativity and Change*, 13(10), 1752-1771.
- Talib, H. H. A., & Ali, K. A. M. (2008, May). Jamaludin Quality assurance in Halal food manufacturing in Malaysia: a preliminary study. In *Proceedings of International Conference on Mechanical and Manufacturing Engineering (ICME2008)* (pp. 21-23).
- Teimourpour, B., & Hanzae, K. H. (2014). An analysis of Muslims' luxury market in Iran: Challenges and opportunities. *Journal of Islamic Marketing*.
- Tieman, M., & Hassan, F. H. (2015). Convergence of food systems: Kosher, Christian and Halal. *British Food Journal*.
- Wang, J., Pham, T. L., & Dang, V. T. (2020). Environmental consciousness and organic food purchase intention: a moderated mediation model of perceived food quality and price sensitivity. *International Journal of Environmental Research and Public Health*, 17(3), 850.
- Weaver, G. R., & Agle, B. R. (2002). Religiosity and ethical behavior in organizations: A symbolic interactionist perspective. *Academy of management review*, 27(1), 77-97.
- Wilson, J. A. (2014). The halal phenomenon: an extension or a new paradigm? *Social Business*, 4(3), 255-271.
- Worthington Jr, E. L., Wade, N. G., Hight, T. L., Ripley, J. S., McCullough, M. E., Berry, J. W., ... & O'Connor, L. (2003). The Religious Commitment Inventory--10: Development, refinement, and validation of a brief scale for research and counseling. *Journal of counseling psychology*, 50(1), 84.
- Wu, B., Liu, S., Wang, J., Tahir, S., & Patwary, A. K. (2021). Assessing the mechanism of energy efficiency and energy poverty alleviation based on environmental regulation policy measures. *Environmental Science and Pollution Research*, 28, 40858-40870.
- Wu, B., Zhai, B., Mu, H., Peng, X., Wang, C., & Patwary, A. K. (2021). Evaluating an economic application of renewable generated hydrogen: A way forward for green economic performance and policy measures. *Environmental Science and Pollution Research*, 1-15.
- Yunus, N. S. N. M., Rashid, W. E. W., Ariffin, N. M., & Rashid, N. M. (2014). Muslim's purchase intention towards non-Muslim's Halal packaged food manufacturer. *Procedia-Social and Behavioral Sciences*, 130, 145-154.

# **Determinants of Purchase Intention of Online Shopping Platforms**

*Suresh A/L Mohanaravi, Nur Aisya Binti Che AB Ghani, Nur Aisyah Binti Amberan,*

*Nurul Atikah Binti Mohamad, Yusuf Adeneye*

*Faculty of Hospitality, Tourism and Wellness, Universiti Malaysia Kelantan*

*Corresponding email: [adeneye.yb@umk.edu.my](mailto:adeneye.yb@umk.edu.my)*

---

## **ABSTRACT**

The study aims to examine the determinants of purchase intention of online shopping platforms. This study extends the Theory of Planned Behaviour (TPB) by introducing product warranty, product information and trusted seller in the development of a theoretical model to study customers' purchase intentions within the context of online shopping platforms. The researcher employed a non-probability sampling technique (i.e., purposive) in this study. Data was collected from 255 users of online shopping platforms in Kelantan through questionnaires and analyzed using descriptive statistics, reliability test, and correlation matrix via Statistical Package for the Social Sciences (SPSS). The findings show that product warranty, product information and trusted seller are significant determinants of customers' purchase intention of online shopping platforms. The findings are beneficial to buyers, sellers, and delivery agents.

**Keywords:** Product warranty, Product information, Trusted seller, Online purchase intention

---

## **INTRODUCTION**

Consumers have developed a habit of shopping online over the past few years. It is fair to say that every group of people, both inside and outside the country, are following this trend more and more closely. Some people believe that shopping online is simpler and more cost-effective because customers can take advantage of more sales and discounts. E-commerce, also referred to as online shopping, allows customers to make immediate purchases from vendors using a shop website or a mobile application. As a result of the Internet's popularity and accessibility, e-commerce can encompass a variety of businesses (Ismail & Masud, 2020). Customers for items received with a credit or debit card when making an online purchase. Numerous online retailers exist, including Lazada, Alibaba, Taobao, Zalora, Amazon, and Shopee. Since the Movement Control Order (MCO) went into effect in March 2020, online buying and selling activity has increased by 28.9% in April 2020 (Lok et al., 2022). Thailand has shown the fastest growth in digital infrastructure across ASEAN countries over the past five years, with Singapore coming in second with 2.31% growth above Malaysia (Ismail & Masud, 2020). Businesses may consider enhancing the fundamental relationship between customers through social media, forums, or directly through the site or "Reviews & comment" section in order to improve social interaction on e-commerce sites

(Khoa & Nguyen, 2022). In terms of network readiness, Malaysia outperformed its neighbours. These initiatives, which support e-commerce growth and help Malaysia achieve its goal of dominating Southeast Asian e-commerce, involve all levels of stakeholders.

To achieve the objective of actual behaviour purchase, online purchase intention is used as an indicator. Consumer behaviour when it comes to purchases is actually dichotomous; either the consumer must buy the product, or they must choose not to. Additionally, consumer purchasing behaviour describes consumer behaviours associated with the acquisition and consumption of goods and services, such as the identification of a need, the search for information, the evaluation of alternatives, the choice to make a purchase, and the actions taken afterward. In order to evaluate products and make a final judgement on which brand would best serve users, product attributes, specs and information from photos, videos, reviews and blogs are needed. An integrated process is used to handle information about customers. Due to the popularity of online shopping and the ease of access to information, this is made possible (Sethna et al., 2017).

The Malaysian e-commerce ecosystem is still developing and needs to make progress in several areas (Ismail & Masud, 2020). Another issue the e-commerce sector must address is how to increase the effectiveness of product warranties. Remanufactured product warranties may be able to increase consumers' willingness to pay (Tang et al., 2020). The impact of product warranties, particularly extended warranties, on e-commerce is significant. Sometimes, a warranty is ultimately rejected. Miscommunication between service centres and brands can result in delays and warranty denial. Due to security and privacy concerns, many online shoppers still prefer to visit physical stores and lack of trust in online sellers. The greater the consumer's faith in the seller, as evidenced by the seller's skill, generosity, and integrity, the more likely they are to make a purchase (Lisnawati et al., 2022). Even though e-commerce is growing in popularity, Malaysia has not yet built a functional e-commerce infrastructure, lagging far behind other countries in this regard. Another challenge includes lack of information about the product. Under the condition of information asymmetry, although consumers cannot obtain objective and detailed product information, consumers form quality perceptions of products and brands with the help of heuristic clues and judge, evaluate and choose based on this (Jurij et al., 2022). A seller's website with comprehensive product information can be a powerful resource for serving customers and enhancing the seller's online presence for citizen search.

Due to its ease of use and ability to offer customers a full range of services, e-commerce presents a variety of business growth opportunities (Koe & Sakir, 2020). The Internet and technological

advancements have significantly altered how people live. They could learn about the world at their fingertips without ever leaving their house. Online shopping may have seemed impractical and unreliable a few years ago, but it is now a common practice. But as savvy buyers, people are urged to exercise caution when making purchases online because some dubious parties, like scammers, may use the situation to their advantage. To avoid being easily duped, users should wisely select a reputable shopping platform before making any online purchases. Accordingly, this study's objective is to investigate three variables which are product warranty, trusted seller, and product information that determine online purchases intention and an online shopping platform.

This study focuses on the factors that influence consumers' intentions to make purchases over the internet through online marketplaces. Particularly since the epidemic, online shopping sites typically rank among the most lucrative industries. Covid-19. Looking at the issues that were discovered, one that can arise is "What is the issue with product warranty in Malaysia?" First off, Malaysia has a poor product warranty. By 2021, owners of newer Volvo automobiles in Malaysia would benefit from a larger covering duration of five years, with little to no mileage restriction (Yap, 2021). He asserts that, like other companies, Volvo has progressively extended its guarantee periods. Previously, innovative Volvos took place with a comparative manufacturer's warranty that had been covered by insurance by a different insurance partner and was valid for an additional two years. The most prevalent written agreements are product warranties, but not much is recognized about influences on their composition or their relationship with dependability and endurance of products. Providing high-quality product warranty to customers is costly for manufacturers in industrial practice. Heavy costs will be incurred by building service facilities, recruiting, and training engineers, or investing in maintenance technologies (Huang et al., 2021).

Another second issue to raise is "What is the issue with product information in Malaysia?", which constitutes the study's second problem statement. One intriguing finding from AsiaPac (2022) is that, compared to other resources, 54.7% of internet users in Malaysia use online platforms to research companies and products. Markets depend heavily on information transfers. Both individuals and businesses base their decisions on information they have learned about their possible transaction partners when determining with whom to interact, which people to employ, or what things to buy. Businesses are vulnerable to disorganization and could cease to function when information is lacking or tend to be erroneous (Etzion & Pe'er, 2013).

Moreover, the issue of trusted sellers in Malaysia is the study's third problem statement. Lazada, Lelong, and 11Street are the most well-known and reputable online shopping websites in Malaysia (Ab et al., 2018). It doesn't imply that they are immune to seller fraud. The quantity of contacts and reviews among the seller's customers is seen as the simplest technique to determine the legitimacy of the seller. Lazada yet again earns the greatest rating as consumer accessibility to the products or services is accompanied by the vendor ratings of 29.5. Building and maintaining connections among purchasers and sellers depends on large part upon trust (Mallalieu & Nakamoto, 2008). Key factors that contribute trust earning behaviours are necessary for sales achievement. Dealing with an undetermined sense of trust is a category that this issue falls under (Brainov & Sandholm, 1999). Buyers acquire ongoing purchasing intents due to their faith in both suppliers and brands, and buyers build brands out of sellers' faith (Zhao et al., 2019). However, online shopping buyers find it difficult to put their trust within the seller because they are open to fraud. This causes individuals to re-evaluate the decision, that could discourage consumers from using e-commerce websites. The study aims to achieve the following research objectives and questions.

### ***Research Objectives***

1. To investigate the relationship between product warranty and purchase intention of online shopping platforms
2. To examine the relationship between product information and purchase intention of online shopping platforms
3. To assess the relationship between a trusted seller and purchase intention of online shopping platforms.

### ***Research Questions***

1. What is the relationship between product warranty and purchase intention of online shopping platforms?
2. To what extent does product information affect the purchase intention of online shopping platforms?
3. What is the relationship between the trusted seller and purchase intention of online shopping platforms?

## **SIGNIFICANCE OF THE STUDY**

The study has some practical significance to buyers who purchase on online shopping platforms, including sellers and delivery agents.

First, this study gives some benefits to buyers. First of all, buyer behavior data is used to estimate and predict buyer acts. Organization must ensure that they receive accurate buyer details in order to make good marketing determinations such as item development and marketing. Second, buyer behaviour differs from person to person. Customers may say one thing but do another. They can often shift their opinion due to an outside influence. As a result, it is critical for businesses to devise effective promotional strategies in order to achieve strong demand.

From a seller point of views, this study is beneficial for people who wants to make a living and selling their product on online shopping platform such as Shopee, Lazada and Tiktok shop. For example, to increase their sales, they need to give details and more information able to their product and the most try as most as possible to give like upper sales services. Giving discount to a trusted seller in terms of the empathy the seller is here, the upper sales service if any problem, the seller can be able to perhaps or replace the product to empathy wise. The most to ensure that the warranty are still in condition are not waste out.

Moreover, this study spreads awareness in the community about how important the trusted seller and the delivery agents are in online shopping platforms. It is because without delivery agents in this platform, it will not thrive until now. In addition, the delivery agents will also be more sensitive to the problems and hardships faced by workers in the online shopping platform to ensure that this platform continues to progress and be recognized and to always ensure that the customer receives a good delivery from them. Not only that, but the delivery agents will also strive to advance this platform by always seeking delivery because this platform is able to become a major contributor to the national economy with the birth of great agents. Other than that, online shopping platforms and indirectly also contribute to national come through foreign currency exchange rates.

## **LITERATURE REVIEW**

The Theory of Planned Behavior (TPB)

The Theory of Planned Behavior (TPB) is a psychology concept that connects thought and action. The theory has three main elements which are subjective norm, attitude, and perceived behavioural control that work together to encourage someone to change their behavioural intentions. According to the Theory of Planned Behavior as stated in the article "Determinants of Customer Repurchase Intention in Online Shopping" (Chiu et al., 2009), trust beliefs produce pleasant perceptions on the

e - retailer which would increase a user's decision to buy products and services from the seller. In addition, The Moderating Role of Trust and Commitment Between Consumer Purchase Intention and Online Shopping Behavior in The Context of Pakistan (Rehman et al., 2019) stated that Theory of Planned Behaviour presents a proper description related to behavioural framework as especially in comparison to Theory of Reasoned Action, according to which a person is meant to perform specific actions only if the person own an actual control on their behaviour. However, according to Moshrefjavadi et al. (2012)'s An Analysis of Factors Affecting on Online Shopping Behaviour of Consumers, information behaviour and purchase behaviour have both been impacted by confidence and perceptions of vulnerability, user's personality, cultural pressure, personalised online capabilities, and digital considerations, such as performance expectancy, relative advantage of use, and quality of website. Demography, network literacy, apparent medium value, and purchasing habits all have an impact on consumers' online purchasing behaviour. In the article "Building Consumer Trust Online," Theory of Planned Behavior claims that consumers who have low trust are less likely to participate in online purchasing due to their wary of seller exploitation and less inclined to purchase with a vendor who failed to inspire confidence (Hoffman et al., 1999). As mentioned by the article "Trust and TAM in Online Shopping: An Integrated Model," Theory of Planned Behavior states that buyers first have faith on their online merchants, thus believe that practicing e-commerce is beneficial (Gefen et al., 2003). Lastly, in the article titled "Prospective Prediction of Health-Related" Behaviour with The Theory of Planned Behavior: A Meta-Analysis," a meta-analysis on Theory of Planned Behavior (TPB) was performed that demonstrates the connection among intention and behaviour, which typically indeed very considerable can dramatically transform.

## **Research Hypotheses**

### **Relationship between product information and online purchase intention**

Hermanda (2019) states that consumer attitudes and behaviours could be influenced by the dissemination of current product information. Online retail stores may also take the role of the party recommending and describing the products through social media posts, which may have an impact on consumers' attitudes, behaviours, and opinions about a product. Consumers who looked for product information frequently considered social media to be a reliable source of information. Given that information shared through social media was more potent at influencing consumer behaviour and purchase intention, the marketing strategy that places a premium on product information would produce a favourable relationship with the brand image.

Aziza and Astuti (2019) mentioned that the ability of advertising to inform audiences about products is known as informativeness. The ability of an audience to tailor the content to suit his or



her own interests and requirements was also discovered to be a predicate for the advertising value of internet advertising. When customers learnt about new items, product advantages, and product information, they saw information as a positive part of advertising. Customers gain brand awareness through efficient marketing communication channels which offer details on product credibility and quality assurance that help customers evaluate and select products with less risk. According to Aziza and Astuti, a customer's intent to purchase anything is influenced by their level of brand awareness. The study also discovered a connection between brand awareness and purchase intention as well as between advertising value and brand awareness.

**H1: There is a positive relationship between product information and online purchase intention.**

### **Relationship between product warranty and online purchase intention**

Indiani and Fahik (2020) examined the effects of warranty in the purchase decision. It mentioned that a sort of security awareness, the existence of a product warranty and its return handling provides the psychological benefit for overcoming buyer's regret. Additionally, consumers may associate warranties with higher service quality from a firm, and perceptions of a company's quality might affect purchasing decisions. The spectrum of consumer wants that undermine confidence varies across different channels of commerce. Data encryption and the availability of a return policy were identified as the two most crucial security features by both groups, according to the cross-cultural study's findings. This finding suggests that e-businesses must first offer a product warranty and present a clear statement informing customers that the website is equipped with encryption technology to safeguard any information they provide.

Singhal (2019) stated that performance warranties often include component substitution and the failure of the product for a long time which could be possibly a year. Cash-back assurances usually have a shorter lifespan but permit returns with no justification. Although offering a guarantee does not need upfront costs, an online retailer will experience unfavourable effects if the goods turn out to be of subpar quality. A substantial warranty policy essentially shows the e-tailer's good faith and suggests that they have adopted a long-term perspective on the connection. Furthermore, offering a substantial warranty coverage can be seen as a sign that the e-tailer is genuinely committed to building a solid reputation, which should reinforce notions of competitive equity. Customers will view an e-tailer's competitiveness value to be stronger the more they believe it has strong leadership credentials, say because it has a solid warranty policy.

**H2: There is a positive relationship between product warranty and online purchase intention.**

### **Relationship between trusted seller and online purchase intention**

Mahliza (2020) the elements of believe in terms of online purchasing intention were investigated, as well as the impact of believe on online purchase outcome. Therefore, Mahliza (2020) used a technique called as purposive sampling. The classification of online questionnaires resulted in a total sampling of 120 survey participants in Jakarta. Partial Least Squares (PLS) was utilized to examine the study's data. The author discovered that marketing strategy and safety are trust significant predictors with a positively significant influence on trust. According to the findings, perceived risk is an antecedent of trust and has significant negative impact on trust. Buyer trust has important positive impact on their online purchase decisions based on the findings.

Yunusa, Saputra, and Muhammad (2022) investigated customer relationship management (CRM) mediation effect in the relationship between digital marketing and internet trust on ecommerce purchases' online purchase intentions in Banda Aceh, Aceh province, Indonesia. The authors chose the sample based on a general principle. Purposive sampling was used to collect information from 150 participants. The authors discovered a positive relationship between CRM and digital marketing and online trust on online purchase intentions.

As all we know, nowadays online shopping platforms are very important at all times, because of the many advantages and benefits, an increasing number of people now prefer online shopping to shopping experience. In recent years, the customer's decision-making process had also shifted dramatically. Consumers carry out extensive research on the internet before speaking with a sales representative. Consumers are indeed starting to make more immediate purchases online and through their smartphones, have not ever entered conventional concrete stores. Promoting business has become much simpler and quicker due to the internet. It has resulted in changes in the way individuals conduct business, with a quickly expanding global trend toward internet purchases or ecommerce.

**H3: There is a positive relationship between trusted seller and online purchase intention.**

### **Research Framework**

The study proposes a research framework to examine the determinants of purchase intention of online shopping platforms by referring to the literature review. Figure 1 illustrates the purpose of this study. The framework consists of three independent variables of the study which are product warranty, product information and trusted seller. Meanwhile the dependent variable is online purchase intention.

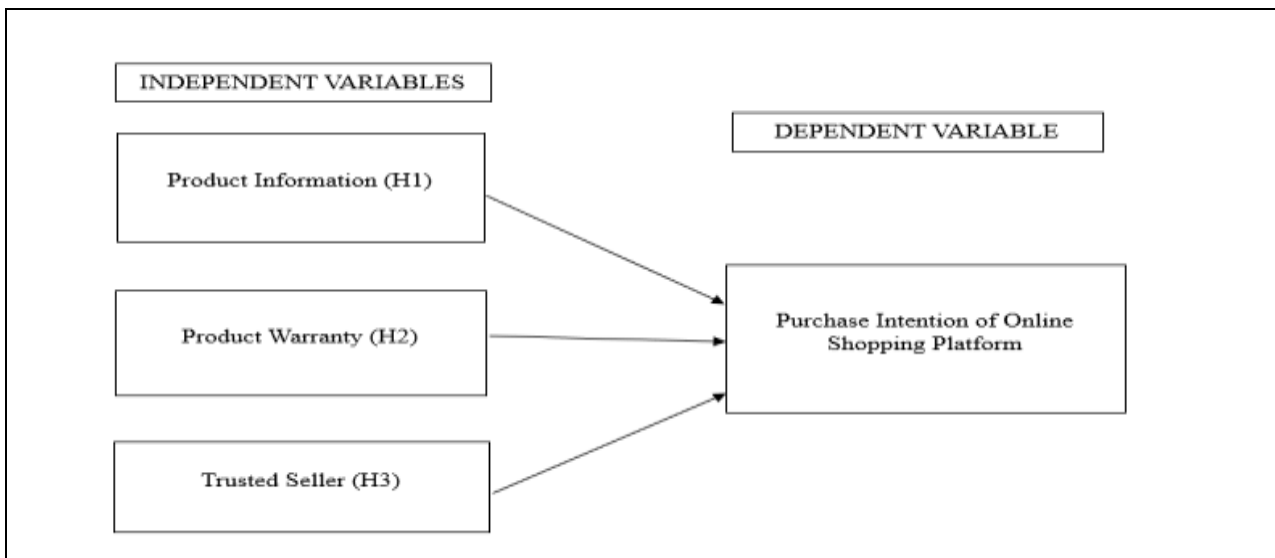

**Figure 2.1:** Conceptual framework of purchase intention of online shopping platforms.

## METHODOLOGY

### Research Design

Research design is the strategy used to carry out a study's objectives or test its hypotheses. This research design provides the framework for the methods and approaches a researcher has chosen. Framework makes it possible for researchers to concentrate on applying research methods that are pertinent to their field and to successfully conduct their studies. Many of the traits of the qualitative analysis process used in grounded theory are also present in design research (Maher et al., 2018).

Exploratory research, descriptive research, and explanatory research are three fundamental types of research objectives. Exploratory research seeks new insights while also figuring out what is going on. In order to assess phenomena and formulate the questions, a new viewpoint is being used. The classification of research known as "descriptive method of research" aims to collect information on a phenomenon's current state (Rahi, 2017). Depending on the research questions, inclusion criteria may be relatively strict or very broad, allowing for rumination of various research designs and types of evidence (Sovacool et al., 2018).

This study uses the quantitative research design. Through the use of broad survey research techniques like questionnaires, quantitative research creates statistics. The benefits of a quantitative research design can be tested and verified; however, rigorous experimental design, as well as the ability to replicate results across different populations, in order to conduct quantitative research. The information gathered is therefore more trustworthy and less subject to doubt. Additionally, it is the simple analysis that will show which statistical tests should be used when collecting

quantitative data. Consequently, data analysis and results presentation are simple, objective, and less prone to error.

### **Data Collection**

The function of collection and analysing data is referred to as data collection about the variables being studied in a way that is systematic and accurate enough to respond to the research questions, test hypotheses, and evaluate results. This study uses a method called "primary data collection," which means that information is gathered from real sources like questionnaires with closed-ended questions. This survey is a self-administered data collection, meaning that respondents are responsible for completing the questionnaire on their own time without the assistance of the researchers.

This study focuses on the people who stay in Kelantan. After the respondents agree to fill out and answer the accompanying questionnaire, they will be told what the purpose of this study is so they can understand what they are being asked to do. There is no obligation to fill out the research questionnaire. The questionnaire will be collected once again after the respondents have finished filling it out.

Data was collected using an online survey strategy, specifically, Google Forms. The questionnaire will collect basic demographic information as well as data on the study's independent and dependent variables. Respondents' perceptions, levels of satisfaction and others can all be measured along a linear scale based on the questions presented to them. When the respondents successfully complete and submit the form, their responses and data reviews will be received via Gmail notification. After that, data collection and analysis will begin immediately.

### ***Research Instrument***

In research from Bastos et al (2014), a research instrument can reliably achieve the same outcomes when used again with the same group of individuals, it is reliable. This idea is frequently used at various stages of the research process, such as when a data collection supervisor conducts a quality control check, when reapplying some questions to the same survey respondents, or even when developing a new instrument in the testing process where the accuracy and consistency of the responses are evaluated. Besides that, a research instrument is a method or set that researchers use to gather information. The work is simple and easy, and the research's findings are clearer, more specific, comprehensive, and systematic (Suharsimi, 2010).

In this research, the researchers use questionnaires to determine the intention to purchase on online shopping platforms. Ary et al., (2018) defines a questionnaire as a tool in which respondents select items to state their responses or submit relevant responses to survey questions. The researchers conducting this research use a questionnaire when collecting data since it ensures that the responses are properly collected. The researchers divide it into two parts which are Part A and Part B. Part A provides information about the respondent’s demographic profile. The respondent will have to answer six items of their profile background such as gender, age group, ethnicity, employment status, marital status, and income group. Meanwhile, Part B contains the independent and dependent variables of the research. The respondent needs to answer four sections of variable items which are Section A for product warranty, Section B for product information variables items, Section C provides trusted seller items, and Section D for items of online purchase intention.

Besides that, the respondent will state their responses through a Likert Scale, which allows for multiple choices for each item given. The Likert Scale has a one to five scale that measures the respondent’s true evaluation. It has five-point items such as Strongly Disagree (1), Disagree (2), Neither/Nor Agree (3), Agree (4), and Strongly Agree (5). The respondent will rate their opinions about the items that are given in every section of Part B. This method will make sure the researchers can easily measure the objective of the study. The items of product warranty were sourced from Blu et al. (2015). The items of product information were sourced from Park and Kim (2003). The items of trusted seller were sourced from Javed and Wu (2020). The items of online shopping platforms were sourced from Kim et al. (2012).

**Table 1**  
Measurement of variables

Product Warranty	1	2	3	4	5
1. The online shop provides me with convenient options for returning items.					
2. The online shop handles product returns well.					
3. The online shop offers a meaningful guarantee.					
Product Information	1	2	3	4	5
1. The site provides up-to-date product information.					
2. The site provides product information easy to understand.					
3. The site provides sufficient product information.					
4. The service is relevant.					
Trusted Seller	1	2	3	4	5
1. Based on my experience with online sellers, I know that they care about their customers.					
2. Based on my experience with online sellers, I know that it is not opportunistic.					
3. Based on my experience with online sellers, I know that they keep their promises to their customers.					
Online Purchase Intention	1	2	3	4	5

1. I intend to continue to purchase goods online from a site that I use regularly.				
2. If I were to buy something, I would consider buying it from online shops.				
3. I intend to recommend the Internet shopping site to other people that I use regularly.				
4. Except for any unanticipated reasons, I intend to continue using internet shopping sites that I use regularly.				
5. I intend to use an internet shopping site that I regularly use as a priority online store for future purchases.				

## Sampling

### *Sampling Technique*

Sampling is a type of statistical analysis in which a set number of observations are taken from a larger group or population. Sampling from the population is often easier and cheaper than trying to reach every single person in the population (Turner, 2020). In general, there are two types of sampling techniques which are probability sampling or random sampling, and non-probability sampling or non-random sampling.

The researcher employed a non-probability sampling technique in this study. Under the non-probability sampling method, the researcher uses convenience and purposive techniques. Non-probability sampling, according to Etikan (2016), is a technique for collecting samples that does not ensure that each participant or unit in the population has an equal chance of being included. Convenience sampling, also known as "haphazard sampling" or "accidental sampling," is a type of nonprobability or non-random sampling where members of the target population are chosen based on practical factors, such as being accessible, nearby, available at a specific time, or agreeable to participate in the study. While purposeful sampling is a method in which certain places, people, or events are chosen on purpose to get important information that can't be gotten any other way (Maxwell, 1996). It also collects data on the population in Kelantan. The study uses this sampling to find out what personal characteristics are present in the respondent population. Before the respondents fill out the questionnaire, the researcher will give them a clear explanation of why the study is being done. This will help the respondents understand the purpose of the study and make sure that they meet the targets. A questionnaire was used by the researcher to gather information. The respondents have comprised of people who are staying in Kelantan.

### *Sample Size*

A sample is a smaller, manageable segment of a larger grouping that is utilised in research. It is a demographic segment containing characteristics out of a larger population. Samples are used in statistical analysis when population's size are too large for those eligible participants or information to be included. A sample should be representative of the general population in its entirety and must

not remain impartial to any characteristic. Despite the desired for a sample to accurately represent the population from which it was selected, there is no guarantee where any sample will do so. A disproportionately high number of atypical observations might be expected by chance. The number of individuals or assessments involved in a research study is referred to as the sample size. Generally,  $n$  is used to indicate this figure. The accuracy of estimations as well as the research's capability to come up with conclusions are two statistical qualities that are influenced by sample size.

To properly carry out the research and obtain reliable, statistically significant outcomes, the sample size must be determined. There seem to be a few techniques for calculating sample size according to various writers of publications. The sample size is ten times the quantity of independent variables or determinants, as according to Hair et al. (2019). (IVs). As per Sekaran and Bougie (2016), the ideal sample size for quantitative investigations must be somewhere among 30 and 500. Also, Krejcie and Morgan (1970) developed a table utilising a sample size formula for limited populations to make figuring out the sample size for a known population easier. When using the Krejcie and Morgan Table, it is essential to understand how many populations there are.

The approach Sekaran and Bougie (2016) recommended is the one this research used to determine the sample size. The sample size for this research would be 200. The sample size has been selected as it falls within sample sizes of 30 and 500 which was recommended by Sekaran and Bougie (2016).

## **Data Analysis**

Data collection, cleansing, and structuring are frequent steps performed by the researcher while using data processing methodologies. To be prepared for any purpose, they must undergo various processes, which often require the use of tools for data analysis. Thorne (2000) asserts that the data analysis method allows in breaking up a significant amount of information into little, comprehensible parts. Additionally, the objective of data evaluation is to gain a deeper comprehension of the information prior of making conclusions.

The correlation analysis was carried out in this investigation. According to Schober et al. (2018), correlation measures how closely two variables are related. When two variables fluctuate in magnitude, they are associated with one another, either in a similar way (positive correlation) or the reverse way (negative correlation). The most typical definition of a linear correlation between two continuous variables when the term "correlation" is employed is the Pearson product-moment correlation. The Pearson correlation reveals the strength of the linear link between two variables.

Its possible values range from -1 to 1, with -1 signifying a negatively skewed total linear correlation, 0 signifying no correlation, and +1 signifying a favourably skewed total linear correlation. Testing statistical hypotheses is another application for inferential statistics. We can precisely decide if there is a significant relationship between two factors. The Pearson correlation coefficient, abbreviated as  $r$ , has a range of values from +1 to -1. The two variables are unconnected if the value is zero. A value which is larger than 0 denotes a positive connection, which means that when one variable's value rises, the other variable's value rises as well. A value which is smaller than 0 denotes a negative association, meaning that the other variable's value decreases as the first variable's value increases.

## **4. FINDINGS**

### **4.1 Demographic Profile**

Firstly, the percentage shows that 143 respondents (56.1 percent) are female meanwhile 112 respondents (43.9 percent) for male out of a total of 255 respondents. For the age group, 118 (46.3 percent) respondents were aged 18 to 24 years and respondents aged 25 to 34 years recorded a total of 73 (28.6 percent) respondents while 37 (14.5 percent) respondents showed the number of respondents aged 35 to 44 years. In addition, respondents aged 45 or more recorded the number of 27 (10.6 percent) respondents. There are 4 ethnic groups involved which is Chinese, Iban, Indian and Malay. The table shows that the highest percentage of the ethnic group is the Malay ethnicity with a percentage of 67.1 percent or 171 respondents while the second highest percentage is recorded by the Chinese which is 17.6 percent or 45 respondents. In addition, respondents from Indian ethnicity are 38 or 14.9 percent of respondents and 0.4 percent or 1 respondent is from Iban ethnicity. The employment status contains of 3 categories such as employed, student and unemployed status. The data for employed status shows 40.4 percent for 103 respondents while 134 or 52.5 percent are respondents among students. Apart from that, respondents from the unemployed status are as many as 18 or 7.1 percent of respondents that involved in answering the survey give. The table shows that 83 or 32.5 percent of respondents are married and respondents from single status were 172 or 67.5 percent of respondents. Finally, the income group of less than RM



1500 was the highest percentage which is 53.7 percent or 137 respondents that answers the survey for this research. Next, the data shows income group from RM 1500 to RM 3000 consist of the total of 40 or 15.7 percent of respondents, 62 or 24.3 percent are collected for respondents with the income of RM 3000 to RM 6000 meanwhile the respondents from the income RM 6000 to RM 9000 are 15 or 5.9 percent. Lastly, the respondents from income group of more than RM 10000 are the lowest percentage with 1 or 0.4 percent of respondents.

**Table 2**

Demographic factors.

<b>Factors</b>	<b>Items</b>	<b>Frequency</b>	<b>Percentage</b>
<b>Gender</b>	Male	143	56.1%
	Female	112	43.9%
<b>Age Group</b>	18 - 24	118	
	25 - 34	73	
	35 – 44	37	
	45 and above	27	

## 4.2 Descriptive Statistics

This study involved 255 respondents and it analyzed the mean and standard deviations for the dependent variable, which is online purchase intention and independent variables, which are product warranty, product information, and trusted seller. Concerning the mean and standard deviations, product information has the highest score (mean = 4.2147, SD = 0.65713) followed by trusted seller score (mean = 4.1673, SD = 0.68726), and product warranty has the lowest score (mean = 3.9974, SD = 0.78425). The score for online purchase intention is (mean = 4.1631, SD = 0.69399). It could be concluded that product information was the most influential factor on determining the purchase intention of online shopping platforms among people in Kelantan.

**Table 3**

Demographic factors of respondents

DEMOGRAPHIC FACTORS	FREQUENCY	PERCENTAGE
<b>GENDER</b>		
Male	143	56.1
Female	112	43.9
<b>AGE GROUP</b>		
18 - 24	118	46.3
25 - 34	73	28.6
35 - 44	37	14.5
45 Or More	27	10.6
<b>ETHNICITY</b>		
Chinese	45	17.6
Iban	1	0.4
Indian	38	14.9
Malay	171	67.1
<b>EMPLOYMNT STATUS</b>		
Employed	103	40.4
Student	134	52.5
Unemployed	18	7.1
Employed	103	40.4
<b>MARITAL STATUS</b>		
Married	83	32.5
Single	172	67.5
<b>INCOME GROUP</b>		
Less Than RM 1500	137	53.7
More Than RM 10000	1	.4
RM 1500 - RM 3000	40	15.7
RM 3000 - RM 6000	62	24.3
RM 6000 - RM 9000	15	5.9

**Table 4**

Total mean score and standard deviation of variables

Variables	N	Minimum	Maximum	Mean	Std. Deviation
Product Warranty	255	1.00	5.00	3.9974	.78425
Product Information	255	1.00	5.00	4.2147	.65713
Trusted Seller	255	1.00	5.00	4.1673	.68726
Online Purchase Intention	255	1.00	5.00	4.1631	.69399

### 4.3 Reliability Analysis

Table 5 shows the reliability dependent variable of online purchase intention is the highest value which is 0.868. For the independent variable of product warranty with 3 questions is 0.798 the

value of Cronbach's Alpha. The second independent variable is product information, and the value is 0.802 with 4 questions. The third of the independent variables is trusted seller and the value is 0.755 with 3 questions.

**Table 5**

Reliability analysis for dependent variable and independent variables

Variable	N	Number of items	Cronbach's Alpha
Product Warranty	255	3	0.798
Product Information	255	4	0.802
Trusted Seller	255	3	0.755
Online Purchase Intention	255	5	0.868

#### 4.4 CORRELATION ANALYSIS

##### **Hypothesis 1: Product Warranty and Online Purchase Intention**

H1: There is a relationship between product warranty and online purchase intention.

The Pearson correlation coefficient, significant value, and number of responses (255) are shown in the table 6. The p-value was 0.001, which was less than the 0.01 level of significance. The correlation value of 0.706 indicated a positive correlation between product warranty and online purchase intention. Hence, H1 is accepted and supported.

##### **Hypothesis 2: Product Information and Online Purchase Intention**

H2: There is a relationship between product information and online purchase intention.

The Pearson correlation coefficient, significant value, and number of responses (255) are shown in the table below. The p-value was 0.001 which was less than the 0.01 level of significance. The correlation value of 0.766 indicated a positive correlation between product information and online purchase intention. Thus, H2 is accepted and supported.

##### **Hypothesis 3: Trusted Seller and Online Purchase Intention**

H3: There is a relationship between trusted seller and online purchase intention.

The Pearson correlation coefficient, significant value, and number of (255) responses were presented in the below table. The p-value was 0.001, which was below the significance level of

0.01. The correlation coefficient of 0.805 demonstrated a positive relationship between trusted seller and online purchase intention. Thus, H3 is accepted and supported.

**Table 6**  
**Pearson correlation analysis**

		PRODUCT WARRANTY	PRODUCT INFORMATION	TRUSTED SELLER	ONLINE PURCHASE INTENTION
1. PRODUCT WARRANTY	Pearson Correlation Sig. (2- Tailed) N	1 255			
2. PRODUCT INFORMATION	Pearson Correlation Sig. (2- Tailed) N	.685** .000 255	1 255		
3. TRUSTED SELLER	Pearson Correlation Sig. (2- Tailed) N	.676** .000 255	.796** .000 255	1 255	
4. ONLINE PURCHASE INTENTION	Pearson Correlation Sig. (2- Tailed) N	.706** .000 255	.766** .000 255	.805** .000 255	1 255

\*\* . Correlation is significant at the 0.01 level (2-tailed).

## 5. DISCUSSION AND RECOMMENDATIONS

### Discussion on Hypothesis 1

The study finds that product warranty has a significant positive correlation with online purchase intention. This is due to the following factors (i) offers a meaningful guarantee, (ii) provides with convenient options for returns, and (iii) handles the product returns well. To achieve the objective of actual behavior purchase, online purchase intention is used as an indicator. The customer's actual decision-making process is a binary choice, either they must buy the product, or they must choose not to. Besides, the product warranty establishes deadlines for customers to make claims for issues with the items they bought and receive solutions like a return, exchange, or maintenance. Following

these reasons, online purchase intention is very important in ensuring that the product warranty for each item purchased is applicable.

### **Discussion on Hypothesis 2**

The study finds that product information has a significant positive correlation with online purchase intention. This is due to the following factors (i) provide up-to-date product information, (ii) provides the product information easy to understand and (iii) provides sufficient product information. In the intention purchasing online, it is crucial to have reliable information that the customer can rely on before making a purchase because they have a legal right to know it. Other than that, customers are constantly seeking additional product details to address any purchase concerns. Customers are more satisfied with a seller who can answer their questions clearly. Following these reasons, to ensure that the customer receives a high-quality product, it is obvious that online purchase intention is closely related to product information before making the decision to buy it.

### **Discussion on Hypothesis 3**

The study finds that trusted seller has a significant positive correlation with online purchase intention. This is due to the following factors (i) good customer care, (ii) legal seller, and (iii) keep their promises to their customers. A trusted seller significantly influences a customer's decision to make an online purchase. If the seller is unreliable, this situation makes customers hesitant to engage in online purchase intention and causes them to worry. Besides, customers can identify an official seller on Shopee by the Shopee Mall icon on their profile and product pages. These sellers have been verified by Shopee to sell products which are 100% authentic. Following these reasons, it shows that trusted seller plays a big role on online shopping platform for customer who buy their product trust them before they purchase.

This section discusses some forms of recommendations that can serve as guidelines for future researchers. Firstly, for the future research it is necessary to expand and increase the target respondents in a larger and more diverse manner. This aims to obtain more systematic data and relevant results as well as encouraging effect on the topic of this study. At the same time, it is proposed to collect data face to face where the researcher can distribute questionnaires to respondents to obtain information quickly and easily and give some souvenir in response to the feedback given. Other than that, future researcher is also encouraged to use this study as a reference and can reinforce any objectives presented on this same topic and add other personal factors that determine the purchase intention of online shopping platforms in terms of age, occupation, and

income. This can further expand the study of a person's personal factors that can affect consumer purchases.

## 6. CONCLUSION

This study aim is to study the determinants of purchase intention of online shopping platforms. A total of 255 consumers of online shopping platforms from Kelantan, Malaysia have been the target respondents and need to answer the questionnaire distributed. Through the research methods used, all research questions and research objectives have been answered and achieved well. Overall, the relationship between independent variable and dependent variable is positive and all these supported hypotheses prove that factors such as product warranty, product information and trusted seller influence the purchase intention of consumers through online shopping platforms.

## REFERENCES

- Ab, M. F., Sh, S., S, R., & Wz, W. Z. (2018, March 29). E-commerce adoption and an analysis of the popular e-commerce business sites in Malaysia. *Journal of Internet Banking and Commerce*. from <https://www.icommercecetral.com/open-access/e-commerce-adoption-and-an-analysis-of-the-popular-e-commerce-business-sites-in-malaysia.php?aid=86828>
- Akter, M., Sadekin, M. N., & Patwary, A. K. (2020). An Empirical Study on Students' Satisfaction from Mawlana Bhashani Science & Technology University, Bangladesh. *Review of Economics and Development Studies*, 6(2), 363-379.
- Alom, S., Patwary, A. K., & Khan, M. M. H. (2019). Factors affecting the turnover intention of Bangladeshi migrants in the United Arab Emirates: An empirical study on the hotel industry. *International Journal of Innovation, Creativity and Change*, 8(3), 344-360.
- Alqahtani, M. A., Al-Badi, A. H., & Mayhew, P. J. (2012). *The Enablers and Disablers of E-Commerce: Consumers' Perspectives*. *The Electronic Journal of Information Systems in Developing Countries*, 54(1), 1–24. <https://doi.org/10.1002/j.16814835.2012.tb00380.x>
- Ary, D., Jacobs, L. C., Irvine, C. K. S., & Walker, D. (2018). *Introduction to Research in Education*. Cengage Learning.
- AsiaPac. (2022, August 3). *Malaysia Digital Marketing 2022: Insight: AsiaPac - Digital Marketing Agency asia*. AsiaPac. from <https://www.asiapacdigital.com/digital-marketing-insight/malaysia-digital-marketing-2022>
- Aziza, D. N., & Astuti, R. D. (2019). *Evaluating the effect of YouTube advertising towards young customers' purchase intention*. Proceedings of the 12th International Conference on Business and Management Research (ICBMR 2018). <https://doi.org/10.2991/icbmr-18.2019.16>
- B, N. (2020b, January 2). *Importance and Significance of Studying Consumer Behaviour*. Essays, Research Papers and Articles on Business Management. <https://www.businessmanagementideas.com/consumer-behavior/importance-and-significance-of-studying-consumer-behaviour/21013>
- Bastos, J. L., Duquia, R. P., González-Chica, D. A., Mesa, J. M., & Bonamigo, R. R. (2014). *Field work I: selecting the instrument for data collection*. *Anais Brasileiros De Dermatologia*, 89(6), 918–923. <https://doi.org/10.1590/abd1806-4841.20143884>
- Blut, M., Chowdhry, N., Mittal, V., & Brock, C. (2015). *E-Service Quality: A Meta-Analytic Review*. *Journal of Retailing*, 91(4), 679–700. <https://doi.org/10.1016/j.jretai.2015.05.004>

- Brainov, S., & Sandholm, T. (1999). *Contracting with uncertain level of trust*. Proceedings of the 1st ACM Conference on Electronic Commerce. <https://doi.org/10.1145/336992.336998>
- Casteel, A., & Bridier, N. L. (2021). Describing populations and samples in doctoral student research. *International Journal of Doctoral Studies*, 16(1).
- Chiu, C. M., Chang, C. C., Cheng, H. L., & Fang, Y. H. (2009). *Determinants of customer repurchase intention in online shopping*. *Online Information Review*, 33(4), 761–784. <https://doi.org/10.1108/14684520910985710>
- Etikan, I. (2016). Comparison of Convenience Sampling and Purposive Sampling. *American Journal of Theoretical and Applied Statistics*, 5, 1-4. [https://www.researchgate.net/publication/304339244\\_Comparison\\_of\\_Convenience\\_Sampling\\_and\\_Purposive\\_Sampling](https://www.researchgate.net/publication/304339244_Comparison_of_Convenience_Sampling_and_Purposive_Sampling) <https://doi.org/10.11648/j.ajtas.20160501.11>
- Etzion, D., & Pe'er, A. (2013). Mixed signals: A dynamic analysis of warranty provision in the automotive industry, 1960-2008. *Strategic Management Journal*, 35(11), 1605–1625. <https://doi.org/10.1002/smj.2178>
- Fengmin, Z., Baijun, W., Jiangtao, B., Li, L., & Patwary, A. K. (2022). Investigating revisit intention of medical tourists in China through nutritional knowledge, perceived medical quality, and trust in the physiologist: A recommendation on health tourism policy measures. *Frontiers in Public Health*, 10, 893497.
- Gefen, Karahanna, & Straub. (2003). *Trust and tam in online shopping: An integrated model*. *MIS Quarterly*, 27(1), 51. <https://doi.org/10.2307/30036519>
- Hair, J. F., Risher, J. J., Sarstedt, M., & Ringle, C. M. (2019). *When to use and how to report the results of PLS-SEM*. *European Business Review*, 31(1), 2–24. <https://doi.org/10.1108/eb-11-2018-0203>
- Hazbar, A. M. H., Alem Mohammed, A., & Karim, A. K. A. (2019). An Empirical Study of Factors Influencing hotel customers' online booking Intention. *مجلة العلوم التربوية و الدراسات الإنسانية*, (5), 1-17.
- Hermada, A., Sumarwan, U., & Tinaprillia, N. (2019). The effect of social media influencer on brand image, self-concept, and purchase intention. *Journal of Consumer Sciences*, 4(2), 76–89. <https://doi.org/10.29244/jcs.4.2.76-89>
- Hoffman, D. L., Novak, T. P., & Peralta, M. (1999). *Building Consumer Trust Online*. *Communications of the ACM*, 42(4), 80–85. <https://doi.org/10.1145/299157.299175>
- Huang, H., Liu, F., & Zhang, P. (2021). To outsource or not to outsource? warranty service provision strategies considering competition, costs and reliability. *International Journal of Production Economics*, 242, 108298. <https://doi.org/10.1016/j.ijpe.2021.108298>
- Indiani, N. L., & Fahik, G. A. (2020). *Conversion of online purchase intention into actual purchase: The moderating role of transaction security and convenience*. *Business: Theory and Practice*, 21(1), 18–29. <https://doi.org/10.3846/btp.2020.11346>
- Ismail, N. A., & Masud, M. M. (2020). *Prospects and challenges in improving e-commerce connectivity in Malaysia*. *E-commerce Connectivity in ASEAN*. Jakarta, Indonesia: Economic Research Institute for ASEAN and East Asia, 78-98.
- Javed, M. K., & Wu, M. (2020). *Effects of online retailer after delivery services on repurchase intention: An empirical analysis of customers' past experience and future confidence with the retailer*. *Journal of Retailing and Consumer Services*, 54, 101942. <https://doi.org/10.1016/j.jretconser.2019.101942>
- Jurij, R., Ilmudin, N. A. A., Peng, L., Ma, M., & Suib, F. H. (2022). *The Influence of Product Quality: A Case Study of Shoppe in Malaysia*. *IIUM Journal of Case Studies in Management*, 13(2), 12-18.
- Kamis, F. F., & Wan Zulkiffli, W. F. (2020). *ONLINE TRUST DEVELOPMENT IN ONLINE SHOPPING*. *Journal of Information System and Technology Management*, 5(18), 26–32. <https://doi.org/10.35631/jistm.518003>

- Khoa, B. T., & Nguyen, M. H. (2022). *The Moderating Role of Anxiety in the Relationship between the Perceived Benefits, Online Trust and Personal Information Disclosure in Online Shopping*. *International Journal of Business and Society*, 23(1), 444-460.
- Kim, C., Galliers, R. D., Shin, N., Ryoo, J. H., & Kim, J. (2012). *Factors influencing Internet shopping value and customer repurchase intention*. *Electronic Commerce Research and Applications*, 11(4), 374–387. <https://doi.org/10.1016/j.elerap.2012.04.002>
- Koe, W.-L., & Sakir, N. A. (2020). *The motivation to adopt e-commerce among Malaysian entrepreneurs*. *Organizations and Markets in Emerging Economies*, 11(1), 189-202.
- Krejcie, R. V., & Morgan, D. W. (1970). *Determining sample size for research activities*. *Educational and Psychological Measurement*, 30(3), 607–610. <https://doi.org/10.1177/001316447003000308>
- Li, L., Ragavan, N. A., Patwary, A. K., & Baijun, W. (2022). Measuring patients' satisfaction toward health tourism in Malaysia through hospital environment, nutritional advice, and perceived value: A study on Chinese exchange students. *Frontiers in public health*, 10, 893439.
- Li, L., Wu, B., & Patwary, A. K. (2022). How marine tourism promote financial development in sustainable economy: new evidences from South Asia and implications to future tourism students. *Environmental Science and Pollution Research*, 29, 1155-1172.
- Li, L., Wu, B., & Patwary, A. K. (2022). The psychosocial factors affecting chinese Outbound Exchange and mobility students' academic performance during COVID-19. *Frontiers in psychology*, 13, 872516.
- Lim, Y. J., Osman, A., Salahuddin, S. N., Romle, A. R., & Abdullah, S. (2016). *Factors influencing online shopping behavior: the mediating role of purchase intention*. *Procedia economics and finance*, 35, 401-410.
- Lisnawati, I., Nailis, W., & Daud, I. (2022). *Does Live Streaming Feature Increase Consumer's Trust on Online Shopping?* *SRIWIJAYA INTERNATIONAL JOURNAL OF DYNAMIC ECONOMICS AND BUSINESS*, 5(4), 373-388.
- Lok, Y. H., Madan, S., Fatini, N. L., Nayley, N., Adira, N. M., Izzah, N., & Ramachandra, R. (2022). *A Study on Consumers' Online Stores Preferences: Comparison between Shopee and Lazada in Malaysia*. *International Journal of Accounting & Finance in Asia Pasific (IJAFAP)*, 5(2), 111-122.
- Maher, C., Hadfield, M., Hutchings, M., & De Eyto, A. (2018). Ensuring rigor in qualitative data analysis: A design research approach to coding combining NVivo with traditional material methods. *International journal of qualitative methods*, 17(1), 1609406918786362.
- Mahliza, F. (2020). *Consumer trust in online purchase decision*. *EPRA International Journal of Multidisciplinary Research (IJMR)*, 6(2), 142-149.
- Mallalieu, L., & Nakamoto, K. (2008). *Understanding the role of consumer motivation and salesperson behavior in inducing positive cognitive and emotional responses during a sales encounter*. *Journal of Marketing Theory and Practice*, 16(3), 183–198. <https://doi.org/10.2753/mtp1069-6679160301>
- Marza, S., Idris, I., & Abror, A. (2019). The Influence of Convenience, Enjoyment, Perceived Risk, And Trust On The Attitude Toward Online Shopping. *Proceedings of the 2nd Padang International Conference on Education, Economics, Business and Accounting (PICEEBA-2 2018)*. <https://doi.org/10.2991/piceeba2-18.2019.40>
- Maxwell, J. A. (1996). *Qualitative Research Design: An Interactive Approach*. Thousand Oaks, CA: Sage Publications.
- McEachan, R. R., Conner, M., Taylor, N. J., & Lawton, R. J. (2011). *Prospective prediction of health-related behaviours with the theory of planned behaviour: A meta-analysis*. *Health Psychology Review*, 5(2), 97–144. <https://doi.org/10.1080/17437199.2010.521684>



- Monperrus, M. (2014). A critical review of "Automatic patch generation learned from human-written patches": Essay on the problem statement and the evaluation of Automatic Software Repair. Proceedings of the 36th International Conference on Software Engineering. <https://doi.org/10.1145/2568225.2568324>
- Moshrefjavadi, M. H., Rezaie Dolatabadi, H., Nourbakhsh, M., Poursaeedi, A., & Asadollahi, A. (2012). *An analysis of factors affecting on online shopping behavior of consumers*. International Journal of Marketing Studies, 4(5). <https://doi.org/10.5539/ijms.v4n5p81>
- Murthy, D. N. P., & Djamaludin, I. (2002). *New product warranty: A literature review*. International Journal of Production Economics, 79(3), 231–260. [https://doi.org/10.1016/s0925-5273\(02\)00153-6](https://doi.org/10.1016/s0925-5273(02)00153-6)
- Newman, I., & Covrig, D. M. (2013). Building consistency between title, problem statement, Purpose, & Research questions to improve the quality of research plans and reports. *New Horizons in Adult Education and Human Resource Development*, 25(1), 70–79. <https://doi.org/10.1002/nha.20009>
- Patwary, A. K., Roy, B., Hoque, R., & Khandakar, M. S. A. (2019). Process of developing a community based tourism and identifying its economic and social impacts: An Empirical study on Cox's Bazar, Bangladesh. *Pakistan Journal of Humanities and Social Sciences*, 7(1), 1-13.
- Pavlou, P. A. (2003). Consumer Acceptance of Electronic Commerce: Integrating Trust and Risk with the Technology Acceptance Model. *International Journal of Electronic Commerce*, 7(3), 101–134. <https://doi.org/10.1080/10864415.2003.11044275>
- Peña-García, N., Gil-Saura, I., Rodríguez-Orejuela, A., & Siqueira-Junior, J. R. (2020). Purchase intention and purchase behavior online: A cross-cultural approach. *Heliyon*, 6(6), e04284. <https://doi.org/10.1016/j.heliyon.2020.e04284>
- Rahi, S. (2017). Research design and methods: A systematic review of research paradigms, sampling issues and instruments development. *International Journal of Economics & Management Sciences*, 6(2), 1-5.
- Rehman, S. U., Bhatti, A., Mohamed, R., & Ayoup, H. (2019). *The moderating role of trust and commitment between consumer purchase intention and online shopping behavior in the context of Pakistan*. Journal of Global Entrepreneurship Research, 9(1). <https://doi.org/10.1186/s40497-019-0166-2>
- Schober, P., Boer, C., & Schwarte, L. A. (2018). *Correlation coefficients*.
- Sekaran, U., & Bougie, R. (2016). *Research Methods For Business: A Skill Building Approach* (7th ed.). United Kingdom: John Wiley & Sons Ltd.
- Sethna, B. N., Hazari, S., & Bergiel, B. (2017). Influence of user generated content in online shopping: impact of gender on purchase behaviour, trust, and intention to purchase. *International Journal of Electronic Marketing and Retailing*, 8(4), 344-371.
- Singhal, D., Jena, S. K., & Tripathy, S. (2019). *Factors influencing the purchase intention of consumers towards remanufactured products: A systematic review and meta-analysis*. International Journal of Production Research, 57(23), 7289–7299. <https://doi.org/10.1080/00207543.2019.1598590>
- Sovacool, B. K., Axsen, J., & Sorrell, S. (2018). Promoting novelty, rigor, and style in energy social science: Towards codes of practice for appropriate methods and research design. *Energy Research & Social Science*, 45, 12-42.
- Suharsimi Arikunto. (2010). *Prosedur penelitian : suatu pendekatan praktik / Suharsimi Arikunto*. Jakarta : Rineka Cipta.
- Sumethokula, P., Patwary, A. K., Srinuanpanc, B., Srinuanpand, C., Suwandee, P., Thammathikul, A., & Phanong, W. (2020). The potential of new tour repackaging for creative tourism among entrepreneurs in Nakhon Si Thammarat. *International Journal of Innovation, Creativity and Change*, 13(10), 1752-1771.

- Takona, J. P. (2002). *Educational Research Principles and Practice*. United States, Universe.
- Tang, J., Li, B.-Y., Li, K. W., Liu, Z., & Huang, J. (2020). Pricing and warranty decisions in a two-period closed-loop supply chain. *International Journal of Production Research*, 58(6), 1688-1704.
- Thorne, S. (2000). *Data Analysis in qualitative research*. *Evidence-Based Nursing*, 3(3), 68–70. <https://doi.org/10.1136/ebn.3.3.68>
- Turner, D. P. (2020). Sampling methods in research design. *Headache: The Journal of Head and Face Pain*, 60(1), 8–12. <https://doi.org/10.1111/head.13707>
- Waas, A. C., Tulung, J. E., & Tielung, M. V. (2022). *Analysis Of Customer Trust On Repurchase Intention In An Online Shop On Instagram (Study Case: Mini Shoppaholics. ID)*. *Jurnal EMBA: Jurnal Riset Ekonomi, Manajemen, Bisnis dan Akuntansi*, 10(1), 289-297
- Wickham, H. (2016). *Data Analysis. Use R!*, 189–201. [https://doi.org/10.1007/978-3-319-24277-4\\_9](https://doi.org/10.1007/978-3-319-24277-4_9)
- Wu, B., Liu, S., Wang, J., Tahir, S., & Patwary, A. K. (2021). Assessing the mechanism of energy efficiency and energy poverty alleviation based on environmental regulation policy measures. *Environmental Science and Pollution Research*, 28, 40858-40870.
- Wu, B., Zhai, B., Mu, H., Peng, X., Wang, C., & Patwary, A. K. (2021). Evaluating an economic application of renewable generated hydrogen: A way forward for green economic performance and policy measures. *Environmental Science and Pollution Research*, 1-15.
- Yap, C. (2021, October 2). *Volvo Car Malaysia offers lifetime warranty for genuine parts*. News and reviews on Malaysian cars, motorcycles and automotive lifestyle. Retrieved January 16, 2023, from <https://www.piston.my/2021/10/02/volvo-car-malaysia-offers-lifetime-warranty-for-genuine-parts/>
- Yunusa, M., Saputra, J., & Muhammad, Z. (2022). *Digital marketing, online trust and online purchase intention of e-commerce customers: Mediating the role of customer relationship management*. *International Journal of Data and Network Science*, 6(3), 935-944
- Zhao, J.-D., Huang, J.-S., & Su, S. (2019). *The effects of trust on consumers' continuous purchase intentions in C2C Social Commerce: A trust transfer perspective*. *Journal of Retailing and Consumer Services*, 50, 42–49. <https://doi.org/10.1016/j.jretconser.2019.04.014>

# Factors Influencing the Intention to Use Fitness Apps Among Generation Z

*Samihah Binti Sharudin, Nuratiera Binti Jassni, Nur Izmahwati Binti Adul Rahman,*

*Siti Aisyah Binti Yasin, Yusuf Adeneye*

*Faculty of Hospitality, Tourism and Wellness, Universiti Malaysia Kelantan*

*Corresponding email: [adeneye.yb@umk.edu.my](mailto:adeneye.yb@umk.edu.my)*

---

## ABSTRACT

This study aims to examine the factors Influencing the Intention to Use Fitness Apps among Generation Z. The study employs the non-probability selection approach of purposive sampling to survey a total of 130 respondents who use different types of Fitness Apps. The data collected was analysed using frequency, descriptive statistics, Cronbach's alpha, and Pearson correlation analysis with the aid of IBM SPSS Statistics version 25 software. The findings of this study reveal that perceived usefulness, perceived ease of use, health consciousness, and dietary culture have significant associations with intention to use fitness apps among generation Z. In conclusion, the findings of this study can be used as a guide for Fitness Apps companies and academics looking to understand further the influence of intention to use fitness apps among Generation Z.

**Keywords:** Fitness apps, perceived usefulness, perceived ease of use, health consciousness, dietary culture

---

## 1.0 INTRODUCTION

Physical activity describes an effective way to improve physical and mental health, lower the risk of chronic diseases, and manage weight. However, according to the World Health Organization (WHO), four out of five teenagers and one out of every four adults do not get enough exercise.

In Malaysia, despite a slight increase in awareness of the benefits of physical activity, many people suffer from chronic diseases and are in poor health. The younger generation, particularly those between the ages of ten (10) and twenty-five (25), is experiencing an increase in the prevalence of high blood pressure and other cardiovascular diseases. Generation Z is the name given to this generation. In light of this, the Malaysian government places a high priority on the general public's health. Several official documents were made available by the State Council between July and September 2019. These documents reaffirmed that physical activity may play an important role in preventing disease and enhancing the health and well-being of people. To give individuals easy ways to physical exercise, you also need to promote the creation of "Internet & Sports" and e-commerce platforms, which could lead to the development of physical and fitness applications.

Fitness applications have grown in popularity in Malaysia because of "Internet & sports". Fitness Apps primarily direct users to engage in physical exercise and enhance their level of health via electronic devices. There has illustrated the effectiveness of using fitness applications to improve physical fitness (Oyibo & Vassileva, 2020). The increasing level of cardiovascular diseases, high blood pressure and other poor health conditions among generation Z requires further studies into the contextual issues affecting the intention to use fitness Apps.

Fitness apps are increasingly being used as a tool by people who wish to work out and lose weight or among people who intend to monitor and manage their health status. This study looks at the elements that determine users' intentions to use exercise programmes and how their health states affect those intentions. The way people work and interact with one another has fundamentally altered due to the recent developments in mobile technology, such as smartphones. Consequently, the fast development of smartphone programs (apps) has provided customers with a variety of services, which were made possible by mobile devices. The significance has been underlined in terms of managing one's own health, and ongoing management is made feasible via mobile smartphone apps. Particularly, these studies frequently failed to account for user preferences for fitness applications, such as health status.

Although it is crucial for fitness app designers and researchers to comprehend users' intentions and individual variances including contextual problems, past studies have not sufficiently covered these topics. Research on users' intentions for fitness applications may also have a big impact on public health policies in the near future. Because users' perceptions of mobile fitness applications can have a big impact on the public healthcare sector, this study investigates the factors that influence users' intentions to use a fitness app in generation Z.

This study addresses four major research problems. Firstly, there is a bad nutrition culture in Malaysia. According the Star Online (2020), there is a significant change in the eating patterns and lifestyle of the people in Malaysia. This has resulted in a large part of the population suffering from non-communicable diseases (NCDs) related to excessive nutrition, as obesity, high blood pressure, heart problems, and cancers. These changes have caused the community to often suffer from NCDs. The authorities are unable to stop the rise of diseases linked to these bad eating habits due to the deteriorating eating style of Malaysians. According to data from the National Health Morbidity Survey (NHMS) in 2019 announced by the Ministry of Health, being overweight and obese is more common than just past the 50% threshold (Stopa et al., 2020). This means that every other adult Malaysian is either obese or overweight. The prevalence of diabetes among adults is 18.3% while high blood cholesterol affects 38.1% of adults. Following the nutrition problem, this

study is motivated to examine whether dietary culture would influence the intentions of people using fitness apps.

Secondly, health care awareness is still low in Malaysia. According to Bernama (2021) in the New Straits Times, there is a highly concerning condition because Malaysia has long been regarded as an unhealthy country due to the high prevalence of heart disease and obesity. This is because people's understanding of health-related issues is still minimal. Furthermore, Malaysia has become one of the countries with the highest rates of obesity and cardiovascular illness. However, to realize the Healthy Malaysia National Agenda (HMNA, 2021-2030), Malaysians must alter themselves and their behavior in order to promote awareness and voluntarily develop a healthy nation and people. This is because the feature of behavior modification is highly significant in raising awareness about the importance of doing a self-health check-up, which is the essence of HMNA. Based on the problem, this study is motivated to explore whether health consciousness would influence the intentions of people using fitness apps.

Thirdly, about one-third of Malaysians do not exercise. According to The Star Newspaper (2014), a Star Online poll on exercise or not, out of 1,742 respondents, 1,243 (71%) said they exercise while 499 (29%) said they don't. A total of 198 respondents (41%) out of 481 people stated that they were too lazy to exercise while 162 people stated that they did not have time because they were too busy with daily affairs. In addition, a total of 36 respondents stated that they could not afford a gym membership while 25 respondents stated that they did not like to exercise. According to Lee (2014) citing the Oxfam International Report of 2001, Malaysia is the sixth-fattest nation in the Asia-Pacific region and the fattest in Southeast Asia. This is because Malaysia has been ranked 44th out of a list of 125 countries. Malaysians are said to often adopt unhealthy eating practices and neglect exercise. There are various reasons given for avoiding exercise. Following the problem, this research is motivated to examine whether perceived usefulness of fitness applications was able to influence the intentions of people using fitness apps in facilitating exercise.

Lastly, a healthy lifestyle is a challenge for most Malaysians. According to Stanford University survey on exercise, Malaysians are the third laziest people in the world to exercise (Yeong, 2022). This has indirectly resulted in a high level of obesity among the Malaysian population. In addition to a lack of access to increased daily physical activity, many people and their families face challenges when it comes to eating healthier. This is because most parents want to provide their children with healthy food, but it is easier and cheaper for them to give their children processed fast foods that was only cause them to become obese just by eating it but are too lazy to exercise

to burn the fat. Following the lifestyle problem, this research was motivated to assess whether perceived ease of use helping to workout would influences the intentions of people using fitness apps.

In this research, the conceptual framework includes four independent variables (IVs) which are Perceived Usefulness (PU), Perceived Ease of Use (PEOU), Health Consciousness (HC), and Dietary Culture (DC). By reviewing past studies which are Zhang and Xu (2020), García-Fernández et al. (2020), Beldad and Hegner (2018), Yang and Koenigstorfer (2021), and the last one is Chiu and Cho (2020), all five research papers from the past studies had mentioned Perceived Usefulness (PU) and Perceived Ease of Use (PEOU) only. The rest of the independent variables that these previous studies examined are level of Satisfaction, Entertainment from using fitness apps, Social Influence, and Perceived Enjoyment.

Hence, from all the independent variables from previous studies, none of them had mentioned about Health Consciousness (HC) and Dietary Culture (DC). This is the main reason why we conduct our current research of study to include other independent variables which are Health Consciousness and Dietary Culture that form parts of the contextual problems of this study. For this current research, we determined to study about the two additional independent variables which have not been mentioned by the previous studies and wanted to continue to further study about Perceived Usefulness and Perceived Ease of Use for generation Z. The study aims to achieve the following research objectives and questions.

### ***1.1 Research Objectives***

1. To examine the relationship between Perceived Usefulness and Intention to use Fitness Apps
2. To investigate the relationship between Perceived Ease of Use and Intention to use Fitness Apps
3. To explore the relationship between Health Consciousness and Intention to use Fitness Apps
4. To assess the relationship between Dietary Culture and Intention to use Fitness Apps

### ***1.2 Research Questions***

To achieve the research objectives, the following research questions were developed to establish the factors influencing the intention to use fitness apps.

1. What is a relationship between Perceived Usefulness and Intention to Use Fitness Apps?
2. What is a relationship between Perceived Ease of Use and Intention to Use Fitness Apps?
3. What is a relationship between Health Consciousness and Intention to Use Fitness Apps?
4. What is a relationship between Dietary Culture and Intention to Use Fitness Apps?

### **1.3 SIGNIFICANCE OF THE STUDY**

The significance of this research is to inspect factors influencing the intention to use fitness apps among generation Z. This study examines the perceived usefulness, perceived ease of use, health consciousness, and dietary culture as determinants of fitness apps' usage. The outcomes of the study could help us further understand and comprehend more factors influencing intention to use fitness apps among generation Z.

Users are confident and believe that the perceived usefulness of fitness apps can help them live healthier lifestyles. Fitness apps can provide a push in the right direction when it comes to health by referring to multiple verified sources. This motivates and influences a person on changing their lifestyle and daily habits until they reach their desired level of fitness. Additionally, users receive new ideas for exercise regimes. Fitness apps have diversified new fitness regimes to intrigue users who do not have time to go to the gymnasium to practice them in order to get the best health results. For instance, the body fitness and jefit applications now include new resistance training recommendations that focus on specific body muscles. Also, fitness apps are regarded as useful because they can keep track of health performance data. Most fitness apps keep detailed records of a person's health over time, such as weight, calories burned, height and calories gained. As a result, users can assess exercise performance accordingly.

On the other hand, fitness apps have features that are simple to use even if the user is connecting with the app for the first time. Smartphone and smartwatch application developers try to create simple user interfaces to understand and make it easy for people to get started. Using a fitness application is a very simple and quick process that involves simply entering health-related questions such as gender, age, weight and questions about various individual health goals. In addition, it's simple to track fitness and health accomplishments with fitness apps at any time. The majority of features found in fitness applications provide exercise guidance, easy-to-follow exercise regime steps, heart rate training, and tracking.

Moreover, the use of fitness apps can boost motivation to exercise, encouraging Malaysians to use this technology because it can help track daily activities. As a result, the use of fitness apps has the potential to disseminate health knowledge, allowing the community to monitor their own health levels. According to the Malaysian Ministry of Health (KKM) in year 2020, a study on Malaysians' health consciousness found that only 6.6 percent more aware compared to the percentage of awareness of the people of the United States which is 12 percent (Harian, 2020). The study considered knowledge of healthy eating habits such as calorie intake, serving size, and fat intake. However, following the spread of COVID-19, Malaysians have begun to be more conscious of their health status since more people expressed interest in improving their health during the Movement Control Order (MCO) period, such as exercising more frequently and eating nutritious food. Besides, society is always busy, and hectic daily schedules make it difficult to find time to care for your health. Thus, the reminder and notification feature of this fitness software assist in sending messages like "Keep it up!" and "You're doing fantastic!". The purpose is to indirectly remind the user of their health goals, ensuring that they are always motivated to exercise. In the smartphone and smartwatch application, badges can be shared with peers and family on social media profiles, contributing to inspiring and motivating others to take care of their health and physical fitness.

In addition, fitness apps can help users control their eating habits and make wise food choices. A healthy food selection is essential during an exercise regimen to help maintain body weight and fitness. Malaysia is a country rich in food resources and various types of food premises such as restaurants and food stalls run by various ethnic groups. The food establishments are always busy and full of customers, indicating that people enjoy eating outside if the prices displayed are reasonable. Additionally, great food is frequently promoted on television as the state's favourite dish, giving Malaysians an urge to explore local cuisine. The wide range of cuisine that is readily accessible has influenced Malaysians' way of life, culture, and customs. Coconut steam rice and flatbread are some of the example well-known and adored dishes in Malaysia. However, consuming these foods consistently throughout the day may be harmful to one's health. This demonstrates how unhealthy eating contributes a rise in the quantity of calories consumed every day, resulting in obesity and overweight. According to the Ministry of Health (KKM) in year 2022, Malaysia has the highest obesity rate in Southeast Asia, at 15.6 percent (Shamsuri, 2022). Thus, fitness apps like Calories Counter and Diet Tracker can help to save a food culture that contributes to a variety of chronic disease risks. This fitness apps can aid in recommending the best form of exercise and help direct or regulate dietary choices. Besides, keeping track of calories consumed



after meals and calories burnt during activity. It also was recommended which food groups to eat based on the proper calorie intake.

## 2.0 LITERATURE REVIEW

### 2.1 Technology Acceptance Model

The theoretical model of this study is based on the original Technology Acceptance Model (TAM) by Davis (1989).

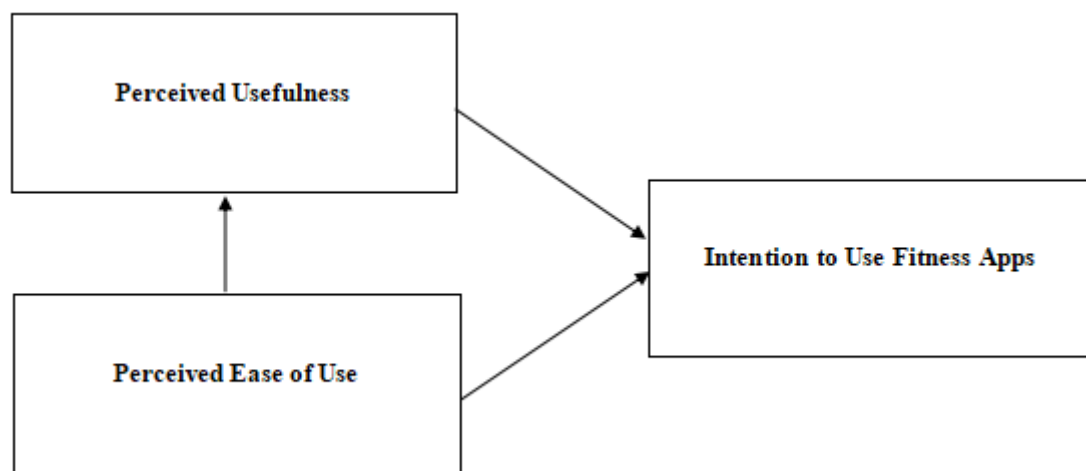

Figure 1: Perceived Usefulness and Perceived Ease of Use are related to Intention to Use Fitness Apps (Beldad and Hegner (2018); Davis, 1989; Chiu and Cho, 2020)

Chiu and (2020) stated TAM theory (Davis, 1989) initially TAM aims to explain computer use behavior which is often widely used to study the technology-related use behavior of individuals across the population and various innovative technologies. TAM is a system-unique model made up of two main comprehensions components, namely perceived usefulness (PU) and ease of use (PEOU). It determines people's attitude both intended practical use of modern technology. PEOU characterized as "the degree to which a person believes that using a particular system will be free of effort" (Davis, 1989, p. 320). Meanwhile, PU is "the degree to which a person believes that using a particular system will improve his work performance" (Davis, 1989, p. 320). In other words, PEOU emphasizes the role of technology in reducing user effort, while PU focusing on the extent to which technology can improve user performance. Thus, TAM argues that PEOU influences PU because the technology is easier to employ, more helpful, and both PEOU and PU perceptions play an important role while influencing people's choices to use technology. TAM is often used by some scholars to study individual consumption and behavior in the context of fitness

applications and health. Therefore, several studies have found TAM to be a very good theoretical framework for describing the intentions of individuals using health and fitness applications.

Beldad and Hegner (2018) stated that research on the use of technology has relied heavily recognising the significance of Davis's TAM effects of two related technologies rules, namely the perception of ease of use and perceived usefulness, on people's willingness to adopt certain technologies. This is because, according to (Davis 1989, p. 320) acceptance of ease of use is 'the degree to which a person believes that using certain systems was free of effort. Then he also defines perceived usefulness as 'a person's degree of belief that using a certain system will improve his work performance. Hence, the diversity of goals targeted by mobile health apps achieve and various features embedded in applications to meet their various objectives, one might expect that an individual's decision to use a particular health application was give the benefits offered by the application and the level of complexity or simplicity in using it. Both support the usefulness of TAM in determining people's propensity to use or keep using a specific application. In research on the use of mobile health applications, it uses TAM as a theoretical basis is in its initial phase and several studies have demonstrated the model's applicability in the context of mobile health applications by emphasizing the effects of both per- feel the usefulness and feel the ease of use on real people their use of health apps and their intention to continue using health apps.

Based on past study by García-Fernández et al. (2020) about using Technology Acceptance Model (TAM) on their study. Based on TAM theory, Davis created this theory in an effort to explain how users and adopters of new information technologies behave. The TAM on this research paper relates two factors which is perceived ease of use (PEOU) and perceived usefulness (PU) with the resulting intent of behaviour and the subsequent real behaviour of the individual. PEOU is the level of thought and consideration necessary for someone to learn how to use technology. Meanwhile, the degree to which people believe a particular system was aid in the completion of a specific task is referred to as PU. The importance of using the TAM model is the positive relationship between its variables and how its impact on attitudes towards technology and intention to use. Due to its excellent resilience and application, the TAM model has historically one of the most used models, with a focus on the technology's practical applications and understanding consumer intent to use fitness apps. Hence, in the sports industry a few studies have examined these factors and discovered there is a connection between PEOU and PU (Ahn et al, 2014; Angosto et al, 2020). In this way, research using TAM has shown that PEOU and PU are influenced by different factors such as

social norms, sociodemographic and health awareness. Therefore, this study includes health consciousness and dietary culture to the TAM theory to examine Fitness Apps' Usage intention.

## **2.2 Research Hypotheses**

### **2.2.1 Relationship Between Perceived Usefulness and Intention to Use Fitness Apps**

Many studies show the link between Perceived Usefulness and Intention to Use Fitness Apps. Zhang and Xu (2020) examined the study's objective related to the mental mechanism that decides whether college students were continue to use fitness applications. The study sampled 379 Chinese college students who completed a questionnaire to determine their user experience. The authors used data analysis techniques such as structural equation modelling (SEM), which was assisted by AMOS 21.0 software. The study discovered that the continuous intention of college students to use fitness apps has significantly and positively impacted on confirmed usefulness. During the interview, the college students stated that, while they did not receive pleasure from the fitness app, they were still motivated to use it because they had a clear goal to achieve fitness and health.

Chiu and Cho (2020) examined the study's objectives related to individuals' choices to utilize health and fitness apps by employing some theory or model, namely the extended technology readiness and acceptance model (TRAM, that merge three other model technology such as readiness (TR), technology acceptance model (TAM), and perceived enjoyment (PEN). Their study investigated the variation in intention to use health and fitness apps linking users and non-users. Chiu and Cho (2020) employed a sample of 206 students selected from four major universities in South Korea, and directly facing interviews were transported accompanying four trained survey administrators to strengthen the study. In their study, the researcher used data analysis techniques like partial least squares structural equation modeling (PLS-SEM) with SmartPLS 3.0 in their study. Chiu and Cho (2020) found that TR absolutely effects perceived usefulness (PU), perceived ease of use (PEOU), and perceived enjoyment (PEN). Furthermore, multigroup analysis demonstrates that app users have a greater association between PU and behavioral intention.

Cho et al. (2020) examined the study's objectives related to the health and decision-making process of users using fitness applications by combining the theory of the Technology Acceptance Model (TAM) and the Investment Model (IM). This study engages a sample of 346 reactions composed of fitness and appropriateness app consumers in China. The authors used descriptive statistics to perform a preliminary test to determine the data assumptions' normality. The authors used structural equation modelling analysis (SEM) to test the proposed hypothesis. Thus, the study

employs standardized factor loadings and t-values of path coefficients to decide the path's strength and significance level of the latent variable. To summarize, the study found that perceived ease of use positively impacts perceived usefulness, which in turn affect influences users to persist in using the apps.

Yu et al. (2021) explored the antecedents of university students' fitness application usage behaviors combined with the theory of planned behavior and the technology model acceptance. The study contained 634 students from six universities in Zhanjiang City the one achieved an online survey to decide the appropriateness of app habit behavior. Using SPSS 18.0 and SmartPLS 3.0 to analyse the data collected, the authors found that perceived usefulness has a significant and positive effect that influences students' attitudes toward fitness apps and increased usage intentions.

Dong et al. (2022) examined the intrinsic and extrinsic factors that explain the intention of Chinese citizens to use fitness applications following the expansion of Technology Acceptance Model. The study sampled 224 Chinese citizens and used data analysis techniques such as Cronbach's alpha coefficient to determine the reliability of the questionnaire and the Kaiser-Meyer-Olkin (KMO) test to determine whether the variables fit the analysis factors through examining their correlation and bias correlation. The authors use the structural equation model with AMOS 24 software and analyzed the path coefficient for the structural equation using the maximum likelihood estimation method to obtain the standardized path coefficient. Dong et al. (2022) discovered that perceived usefulness has a significant and positive effect on people's willingness to use fitness applications. Hence, we hypothesize that:

**H1: There is a positive relationship between Perceived Usefulness and Intention to Use Fitness Apps**

### **2.2.2 Relationship Between Perceived Ease of Use and Intention to Use Fitness Apps**

Many studies show the connection between Perceived Ease of Use and Intention to use Fitness Apps. García-Fernández et al. (2020) examined study's objective related to analyze the association between e-lifestyle of Boutique Fitness centers and influence different relationships with perceived ease of use and intention to use fitness apps. The study the sampled 591 Boutique Fitness customers (378 female, 213 male). The selection criteria for participation in the survey is that the participants had to download a fitness app. The authors used data analysis technique involves confirmatory factor analysis (CFA) and structural equation model (SEM). The study contributed to understanding how e-lifestyle are associated to technology in relation to fitness apps, and which may make it easier to predict fitness consumption behaviors.

Beldad and Hegner (2018) examined study's objective related to analyzing the relationship between German users' willingness to continue to use fitness apps and influence relationship of perceived ease of use and perceived usefulness. The data collected through self-administered online surveys and here are 476 responses. Beldad and Hegner(2018) used data analysis involves confirmatory factor analysis (CFA) and structural equation modeling (SEM) technique. The authors found that the intention of respondents to keep up using a fitness app is originally believed to be influenced by including perceived usefulness and perceived ease of use. Hence, results showed user perception of the fitness app is related to the perceived ease of use.

Gómez-Ruiz et al. (2022) examined study's objective related to analyze the aspects that can influence consumers intents to use fitness apps based on how appealing the fitness apps are. The authors used the technology acceptance model (TAM), structural equation modelling (SEM) exploratory factor analysis (EFA) and confirmatory factor analysis (CFA). An online questionnaire was distributed to 200 sports consumers of a fitness centre (117 women and 83 men) to determine user's viewpoint of the attractiveness, perceived usefulness, perceived ease of use, enjoyment, trust, and intention to use of the fitness center's fitness app. The study found that the variables studied have a positive influence on the intention to use fitness apps, with attractiveness and usefulness, as well as perceived ease of use and intention to use are having the strongest associated. These results highlight how crucial these factors are when using fitness applications in fitness facilities.

**H2: There is a positive relationship between Perceived Ease of Use and Intention to Use Fitness Apps**

### **2.2.3 Relationship Between Health Consciousness and Intention to Use Fitness Apps**

Many studies show the relationship between Health Consciousness and Intention to use Fitness Apps. Damberg (2021) examined study's objective related to the role of fitness app users in the United Kingdom in determining future use intention of Health Consciousness. The study sampled 500 respondents was solicited using an online panel through Harris Interactive. The authors used data analysis techniques such as partial least squares structural equation modeling (PLS-SEM) to test and analyze the relationship in the model. The study found the role that health consciousness plays as a motivator of future consumption intentions. Therefore, the desire to use a product in the future is primarily impacted not only by routines and a sense of amusement, but also by health consciousness and application performance. This suggests that users of fitness health

consciousness applications are another key factor to consider when forecasting future use intentions for fitness apps.

Chen and Lin (2018) examined the objectives of the study is to enhance the model's capacity to forecast a person's attitude and intention to download and utilise nutrition and fitness applications by expanding the technology readiness and acceptance model (TRAM) to consider the person's health consciousness (HC). The study sampled 994 people who completed the online self-report questionnaire. The authors used data analysis techniques such as structural equation modelling (SEM) to statistically test hypothesized models and determine the model's consistency with the sample data. The study found that HC has a favourable impact on how simple and practical diet and exercise applications are judged to be. The suggested HC-TRAM offers a greater predictive potential than the TRAM, according to two distinct test findings.

Yan et al. (2021) examined the mobile applications for healthy living with affecting variables Plans to keep using health apps. Previous studies have looked into the variables that affect a health app's adoption. However, very few researches for mobile health apps have considered Continuance Intention (CI). The study sampled 397 users of a health app in China to validate the model. The authors used data analysis technique such as Partial Least Squares (PLS). The study found that factors such as perceived usefulness, perceived ease significant determinants of CI and satisfaction are frequency of usage, flow experience, and behavioural modification techniques acts as a mediator between these factors and their effects. The influence of health consciousness on the relationship between perceived usefulness and satisfaction is moderated in a positive way, whereas the effect of health consciousness on the relationship between perceived ease of use and contentment is moderated in a negative way. Hence, we hypothesis that:

**H3: There is a positive relationship between Health Consciousness and Intention to Use Fitness Apps**

#### **2.2.4 Relationship Between Dietary Culture and Intention to Use Fitness Apps**

Koo at el. (2016) examined that this study aimed to assess consumption patterns of dietary culture and intention to use fitness apps among generation Z. Regardless of socioeconomic situation, follow the remaining six food groups recommended by the Malaysian Dietary Guidelines. It is important to try to promote balanced, healthy eating, especially for foods that don't meet the recommended intake levels. Generation Z's ideal growth rates are encouraged by appropriate nutrition, which is essential for good health and was directly affect their adult health. According to the Food and Agriculture Organization (FAO) and the World Health Organization, each nation

should create fundamental food-based dietary guidelines based on their public health issues and suitable for people of different cultures, lifestyles, and ages (WHO). The Malaysian SEANUTS, a cross-sectional survey of Malaysian children that is nationally representative, provided the data for this study. Using stratified multistage selection, Generation Z members of all ethnicities (Malay, Chinese, Indian, bumiputra Sabah, bumiputra Sarawak, and other bumiputra) were randomly selected from six Malaysian regions. The structure and operations of SEANUTS Malaysia have been fully described elsewhere. To the best of our knowledge, this study is the first to undertake a dietary culture-based analysis on a sample of Malaysian Generation Z from various socioeconomic backgrounds that is nationally representative. By detailing the consumption patterns of the seven food categories in accordance with the Malaysian Dietary Guidelines, which covered Generation Z from all six regions of Malaysia, this research considerably contributes to the literature. The results of the current study show that the mean intake of all food categories did not match MDG requirements, with the exception of meat and poultry. The differences in eating habits between young people from urban and rural areas in Malaysia can be explained by the nutritional transition from a traditional to a modern or Western lifestyle. The results of this study suggest that with current technology, fitness apps can inspire generation Z to maintain a healthy lifestyle and improve the efficacy of dietary culture.

Many studies show the relationship between dietary culture and intention to use fitness apps. Suzuki and Tachihara (2014) examined the study's objective related to aims at the preservation of the region's historic nutritional culture, although with a modern perspective, by identifying key designing-a-living components and outlining future goals. Since they are the driving force behind change and the important players in completing this crucial mission for the benefit of future generations, Generation Z is one of the major target groups. Family and community bonds have been severely disrupted as a result of globalisation, media social loss of traditional culinary culture, and has led to a disdain for natural resources. The study of constructing a lifestyle in Ngiwal State, Republic of Palau, tries to highlight the significant problems associated with this continuous societal transition and to provide answers that will help communities and people manage them. From May 2010 to April 2011, a study team from Chiba University made three trips to the research location to conduct in-depth interviews and gather information on the local traditional food culture and public opinion. The team draws the following conclusions after analysing the data. The locals are aware of the value of traditional food culture; however, this is not reflected in reality or in their behaviour. Implementing the "designing-a-living" idea should incorporate key design components including communication, cooperation, social media, and others in order to transmit the social ideals embodied in this food culture to future generations. In order for people in deeper regions to

keep a healthy lifestyle with apps for their food culture, they need be made aware of the advantages and benefits of utilising fitness applications. Hence, we hypothesize that:

**H4: There is a positive relationship between Dietary Culture and Intention to Use Fitness Apps**

### 2.3 Research Framework

Based on the research hypotheses, this study proposes an advanced TAM theory by evaluating the Factors Influencing Intention to Use Fitness Apps Among Generation Z. Thus, the research framework as shown below.

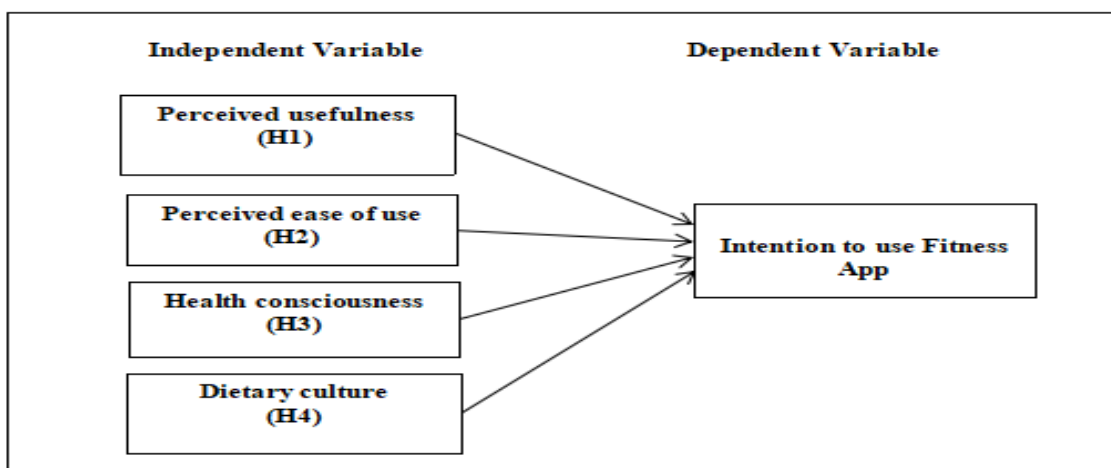

Figure 1: Conceptual framework of the study

Figure 1 shows that the research framework and it contains two variable which is the dependent variable (DV) and the independent variable (IV). The intention to use a fitness app is the dependent variable, and the four independent variables are perceived usefulness, perceived ease of use, health consciousness, and dietary culture. This framework explains the relationship between the independent variables, which are perceived usefulness, perceived ease of use, health consciousness, and dietary culture, and whether it shows a positive or negative effect on the dependent variable, which is intention to use fitness apps.

The findings from previous research established that perceived usefulness and perceived ease of use are related to a user's intention to use technology, with both having a positive effect on fitness applications. This is due to the numerous advantages of using fitness apps, such as saving time, having simple features to use, being user-friendly, and so on. Following that, health consciousness and dietary culture are important factors in the user's intention to use fitness applications, with giving an approach to boost motivation to exercise, control eating habits, and make wise food



choices being an important element that results in the user's decision to use fitness applications among generations Z.

### **3.0 METHODOLOGY**

#### **3.1 Research Design**

According to Saunders, et al. (2012), a research design is a strategy for answering the study's questions. It entails proper research data management as well as the collection of various components, strategies, and methods for data collection and analysis. Meanwhile, according to McCombes (2019) research design is also known as a research strategy is a strategy to answer a series of inquiries. It is a framework that incorporates techniques for gathering data, analysing it, and interpreting it. To put it another way, the research design describes the method through which the main problem of the study was investigated.

This study uses quantitative research approach. According to Creswell (2002), quantitative research is the process of collecting, analyzing, interpreting, and documenting research findings. The quantitative research process has the advantage of being tested and checked. Quantitative research necessitates careful ability to repeat the test and the outcomes, as well as an experimental design. This improves the accuracy of the data gathered and lessens the likelihood of disagreement. Furthermore, the analysis is straightforward. When gathering quantitative data, the type of results was influencing the statistical test to be used. As a result, quantitative research makes it simpler and less sensitive to subjectivity and error to interpret data and report results.

In this study, the correlative study design was used. A correlational study is a form of research design that explores the link between two or more variables (Leech et al., 2022).

#### **3.2 Data Collection**

A research instrument is one of the measurement tools that can assist the researcher in collecting data and all of the information required to complete the research (Sathiyaseelan, 2015). In this study, data was gathered by the researchers using a questionnaire. Thus, the technique for gathering data is the questionnaire for researchers that requires respondents to answer questions or items based on their experience, attitude, or opinion.

In this study, the questionnaire has four sections. Section 1 displays a cover letter which introduces the topic and states the purpose of the study. Section 2 describes the demographic information

which include the age group, the gender, income group, race, and marital status. Section 3 presents the variable items of the IVs and DV. The variables items are sourced from different studies comprising five sections which are Section A, Section B, Section C, Section D, and Section E. Section A focuses on the dependent variable (DV) which is Intention to Use Fitness Apps. The items on Intention to Use Fitness Apps was sourced from Acikgoz et al. (2022) and García-Fernández et al. (2020). Section B, C, D and E consists of independent variable (IV) which are health consciousness, dietary culture, perceived ease of use and perceived usefulness. Variable items in the health consciousness were sourced from Acikgoz et al., (2022), Iqbal et al., (2021) and Park et al. (2017). Variable items on dietary culture were sourced from Sanusi (2020). Variable items on perceived ease of use and perceived usefulness were sourced from Acikgoz et al., (2022), Zhang and Xu (2020), and García-Fernández et al., (2020). The questionnaire items as shown below.

**Table 1**  
**Variable Items**

A. Intention to use Fitness Apps	1	2	3	4	5
1. I know how to judge the quality of a fitness apps.					
2. I do not feel very knowledgeable about fitness apps.					
3. I intend to use fitness apps within the next three months.					
4. I intend to use fitness apps for my training.					
5. I intend to use fitness apps as often as possible.					
6. I will use fitness apps on a regular basis in the future.					
7. I will frequently use fitness apps in the future.					
8. Assuming I have access to fitness Apps, I intend to use them.					
9. Given that I have access to fitness Apps, I predict that I would use them.					
B. Perceived Usefulness	1	2	3	4	5
1. I use fitness apps to improve the quality of my exercising.					
2. Fitness apps save me time.					
3. I use fitness apps to improve my training/ workout performance.					
4. Fitness apps are useful for doing exercise.					
5. I use fitness apps to enhance my effectiveness in doing exercise.					
6. I use fitness apps to increase my productivity in doing exercise.					

C. Perceived Ease of Use	1	2	3	4	5
1. Overall, I find fitness apps easy to use.					
2. It is easy for me to remember how to perform tasks using fitness apps.					
3. Learning to use fitness apps is easy.					
4. Interaction with fitness apps is clear and understandable.					
5. It is easy to interact with fitness apps.					
D. Health Consciousness	1	2	3	4	5
1. I am self-conscious about my health.					
2. I take responsibility for the state of my health.					
3. I reflect on my health a lot.					
4. I am alerted to changes in my health.					
5. I am aware of the state of my health as I go through the day.					
6. Good health requires active participation on my part.					
7. I am worried about my health when I get sick.					
8. Living life without disease and illness is very important to me.					
9. My health depends on how well I take care of myself					
10. Living life in the best possible health is very important to me.					
11. I do worry about harmful chemicals in my food.					
12. I am concerned about the quality of my drinking water.					
13. I usually read the ingredients on my food labels.					
14. I read more health-related articles than I did 3 years ago.					
15. I am interested in information about my health.					
E. Dietary Culture	1	2	3	4	5
1. I eat a variety of foods within my recommended intake.					
2. I maintain body weight in a healthy range.					
3. I am physically active every day.					
4. I eat an adequate amount of rice, others cereal products (preferably whole grain) and tubers.					
5. I eat plenty of fruits and vegetables every day.					
6. I consume a moderate number of fish, meat, poultry, egg, legumes, and nuts.					

7. I consume adequate amounts of milk and milk products.
8. I limit intake of foods high in fats
9. I minimise fats and oils during food preparation.
10. I choose and prepare foods with less salt and sauces.
11. I consume foods and beverages with low sugar.
12. I drink plenty of water daily.
13. I practice exclusive breastfeeding from birth until six months and continue to breastfeed until the child is two years of age.
14. I consume safe and clean foods and beverages.
15. I make effective use of nutrition information on food labels

### 3.3 Sampling

#### 3.3.1 Sampling Technique

Sampling is a method of choosing an adequate number of components from a population for researchers to examine a sample and comprehend their features to generalize those properties or characteristics to the elements of the population. There are two different kinds of sampling techniques which are probability and non-probability sampling techniques. The probability sampling technique is one, where every member of the population is likely to be chosen as a sample, whereas a non-probability sampling technique does not give every member of the population the same opportunity to participate in a study. For this study, the respondents who will be chosen is generation Z.

Purposive sampling is the method of sampling that is employed in the study, which is under the group of non-probability sampling techniques. This method relies on the researcher's judgment and criteria when selecting members from the population to take part in the survey. For instance, people who meet the qualifications for the required characteristics can assist the researchers in answering the research question.

Aside from that, the use of the purposive sampling technique in this study has the advantage of being the most cost-effective and saving time. Purposive sampling is the most appropriate sampling method available to contribute to this study if there are fewer than a few primary data sources and is suitable for studies that require some selection criteria i.e., only respondents who qualify under the age group of generation Z can participate in this study. Also, only respondents from generation Z who use Fitness Apps took part in this research.

### **3.3.2 Sample Size**

A sample is a smaller and manageable element than a larger group. A sample is a subset that represents the size of the entire population. Sample members are known as subjects, whereas the number of subjects in the sample is known as sample size. Usually, a sample size can be determined by the population because when the number of the population increases, the simple size was also increase. The sample size can be determined by 10 times the number of predictors or independent variables (Hair et al., 2019).

In this study, researchers intend to choose 170 respondents in total from generation Z users of fitness applications in Malaysia to serve as the study sample. This is due to the fact that the sample size cannot be less than 30 respondents or greater than 500 respondents. The best sample size for quantitative investigations, according to Sekaran and Bougie (2016), is between 30 and 500 participants.

The sample size selected in this study is very appropriate and sufficient because the generation Z population in Malaysia is large, necessitating a smaller sample size for this study. Because generation Z is exposed to the increasing use of technology, researchers can easily access the accessibility of participants. As a result, a sample size of 170 can determine the accuracy and effectiveness of the sample size, increasing confidence that it was comprehensively address the existing gap

### **3.4 Data Analysis**

A data analysis technique is a method used by researchers to convert data into a narrative and then analyze it to make closure. The data analysis method assists in breaking down a large amount of data into smaller fragments. Data analysis is mainly used to obtain any relevant information from data and then apply that knowledge to decide. This study was perform the correlation analysis to analyze the association between the independent variables and dependent variable and establishes the strengths of the association between each IV and DV. The data analysis of this study was analyzed using descriptive statistics and Pearson's correlation.

Descriptive statistics are specific methods used to measure, characterize, and outline research info in a reasonable, important, and effective way. Descriptive statistics assist in detailing and comprehending the traits of a specific data set by providing brief analyses of the sample and data

measures. Descriptive statistic includes frequency, central tendency, dispersion and distribution measures. This study uses descriptive statistics because it simplifies the data's interpretation while simultaneously providing the researchers with the knowledge to conduct further analysis.

Correlation analysis refers to a method that describe the linear association between two different variables. With correlation analysis, researcher could see the patterns and define how linear it is. There are types of correlation analysis which are Pearson correlation and Spearman correlation. Thus, there are two relationships of correlation analysis which are positive correlation and negative correlation. Positive correlation is an association between two variables which means the increase of one variable can causes an increase for another variable. Meanwhile, negative correlation means the increase of one variable cause a decrease in another variable. The perfect correlation positive is in between two values at all if the result is the between -1. Perfect positive correlation between two values indicates 1. When, the result is shown 0, this means that there is no relation between the IVs and DV. Overall, a perfect correlation generates a straight line on a graph. The correlation is perfect positive if two variables point in a direction that is a constant positive or negative direction. Whereas the correlation is perfect negative if both variables change in the opposite direction which is one increases while the other lowers or vice versa.

## 4.0 FINDINGS

### 4.1 Demographic Profile

Table 2 shows the frequency of demographic profile. According to the table below, this study consists of 130 respondents and the frequency of using Fitness Apps according to the demographic profile. The demographic profiles include gender, age group, race, marital status and income group. For gender, it can be seen that the highest frequency of using Fitness Apps is female with 84.6% compared to male which is 15.4%. Based on age group, the highest frequency was from age 23 to 25 years old with a percentage 63.9 and the highest frequency for race was malays which is 88.5%. Then the highest frequency for marital status was single compared than married. Lastly, the frequency for income group which is the highest was for income less than RM1000.

**Table 2**  
**Frequency**

Profile	Frequency	Percentage
---------	-----------	------------

Gender	Male	20	15.4
	Female	110	84.6
Age Group	10-18 years old	3	2.3
	19-22 years old	44	33.8
	23-25 years old	83	63.9
Race	Malay	115	88.5
	Indian	2	1.5
	Other	13	10.0
Marital Status	Single	121	93.1
	Married	9	6.9
Income Group	< RM 1000	96	73.8
	RM 1001 - RM 1500	34	26.2

## 4.2 Descriptive Statistics

Table 3 shows the total respondent, mean score, and standard deviation of independent and dependent variables. According to the table above, this study comprised 130 respondents who used Fitness Apps to examine the mean and standard deviation for the five variables. For the independent variable, health consciousness was the highest mean, which is a mean of 4.286 with a standard deviation of 0.59155, second highest followed by perceived usefulness score (mean=4.2000, SD=0.76119), followed by the third score is perceived ease of use which was (mean=4.1846, SD=0.74568), and dietary culture has the lowest score (mean=3.9338, SD=0.66296). Meanwhile, the mean for the dependent variable which is the intention to use Fitness Apps was (mean= 3.8402, SD= 0.59651). To conclude, the independent variable of health consciousness was the most influential on the intention to use Fitness Apps among Generation Z.

**Table 3**

**Descriptive statistics of the main variables**

No	Variables	N	Mean	Standard Deviation
1	Health Consciousness	130	4.2862	.59155
2	Dietary Culture	130	3.9338	.66296
3	Perceived Usefulness	130	4.2000	.76119
4	Perceived Ease of Use	130	4.1846	.74568
5	Intention to Use Fitness Apps	130	3.8402	.59651

### 4.3 Reliability Test

Table 4 shows the reliability statistics for independent variables and dependent variable of the analysis using Cronbach's alpha. The study includes four independent variables: health consciousness, dietary culture, perceived usefulness, and perceived ease of use, and one dependent variable: intention to use fitness apps. The independent variables have excellent internal consistency, indicating high trustworthiness. The dependent variable, intention to use fitness apps, has a Cronbach's alpha value of 0.829, indicating good reliability and respondents' understanding of the questions. Overall, the study's results are reliable and acceptable.

**Table 4**

#### **Reliability Statistics for Independent variables and dependent variable**

Variables	Number of items	Cronbach's Alpha
Health Consciousness	15	0.936
Dietary Culture	15	0.925
Perceived Usefulness	6	0.943
Perceives Ease of Use	5	0.937
Intention to Use Fitness Apps	9	0.829



#### 4.4 Pearson Correlation Result

The table 5 shows the Pearson correlation coefficient, the significant value, and the total number of responses (130) for all independent variable. For perceived usefulness, the p-value is 0.01 which is the correlation level of significant. The correlation value of 0.565 indicated a high positive correlation between perceived usefulness and intention to use fitness apps, which is significant at 1% level. Therefore, H1 is accepted and supported.

Then, for perceived ease of use, the p-value is 0.01 which is the correlation level of significant. The correlation value of 0.462 indicated a positive correlation between perceived ease of use and intention to use fitness apps.

After that, for health consciousness, the p-value is 0.01 which is the correlation level of significant. The correlation value of 0.466 indicated a positive correlation between health consciousness and intention to use fitness apps.

Lastly, for dietary culture. The p-value is 0.01 which is the correlation level of significant. The correlation value of 0.399 indicated a positive correlation between perceived usefulness and intention to use fitness apps.

**Table 5**

#### Pearson Correlation

		Intention to Use Fitness Apps	Intention to Use Fitness Apps
Perceived Usefulness	Pearson Correlation	.565**	1
	Sig. (2-tailed)	.000	
	N	130	130
Perceived Ease of Use	Pearson Correlation	.462**	1
	Sig. (2-tailed)	.000	
	N	130	130

Health Consciousness	Pearson Correlation	.466**	1
	Sig. (2-tailed)	.000	
	N	130	130
Dietary Culture	Pearson Correlation	.399**	1
	Sig. (2-tailed)	.000	
	N	130	130

Asterisk \*\* indicates that it is significant at 1% while asterisk \* indicates that it is significant at 5%.

## 5. DISCUSSION AND SUGGESTION FOR FUTURE STUDIES

The outcomes of the research findings of this study have provided insight into discussion for the positive relationship between independent variables (IVs) which are Perceived Usefulness (PU), Perceived Ease of Use (PEOU), Health Consciousness (HC), Dietary Culture (DC) and the dependent variable (DV) which is Intention to use Fitness Apps. Therefore, the suggestion for future studies was also provided.

### 5.1 Hypothesis 1

Hypothesis 1 shows that there is a significant positive association between Perceived Usefulness and Intention to Use Fitness Apps. This finding is due to the following reasons:

#### i) Quality of exercise

Fitness apps are able to make the exercise of the users become more quality. This is because fitness apps offer variety of workouts and explain well the proper way to do physical activity in accordance with the wishes of the users. As a result, users could get benefits from the use of fitness apps to improve their quality of exercise which also contribute in the quality of life. Thus, perceived usefulness of fitness apps could influence Gen Z people's intention to use them.

#### ii) Time saving

Individuals who use fitness apps are the ones who save more time than the people who do not used to it. This is because Fitness Apps have been input time feature which helps users to set the schedule of their exercise and assign on how many sets/repetitions each of the

exercises they need to do. As a result, fitness can help user to have a regular workout routine.

### **iii) Training/workout performance**

Fitness apps are designed to help users to get the proper and right exercise as this fitness app has multiple fitness features such as providing a variety of exercise, monitor and track the fitness activity and even advanced personal trainers. As a result, this definitely helps users to a better training or workout performance which also can enhance productivity.

## **5.2 Hypothesis 2**

Hypothesis 2 shows that there is a significant positive association between Perceived Ease of Use and Intention to Use Fitness Apps. This finding is due to the following reasons:

### **i) Easy to use**

Most fitness apps are easy to use because all the illustrations, design and features are in well placed. In addition, all the layout arrangements in the app are straightforward and simple, helping users to easily find what they need without confusion. As a result, users from a variety of ages could easily download the fitness and all the procedures from sign in until getting in the app are effortless easy because the apps had provided easy instructions. Hence, perceived ease of use of fitness apps could influence Gen Z people's intention to use them.

### **ii) Easy to remember how to perform tasks**

Majority of the fitness apps are often paired with wearable devices such as smartwatches or fitness bands. These wearable devices have provided real time data on metrics such as steps taken, calories burn and reminder to do daily exercise. As a result, this sync connection between the fitness apps and wearable devices allows users to easily track their fitness activity and remind them to perform their workout routine.

### **iii) Clear and understandable**

All the guidelines or instructions that have been provided in fitness apps are clear and written with easy-to-understands instructions. The majority of fitness apps offer comprehensive instructions and guidance on how to carry out exercises, monitor progress

and use the different features. To illustrate proper methods, fitness apps frequently included pictures, videos and step by step explanations.

### **5.3 Hypothesis 3**

Hypothesis 3 shows that there is a significant positive association between Health Consciousness and Intention to Use Fitness Apps. This finding is due to the following reasons:

#### **i) Individuals are responsible for the state of their health**

All people have the ability to make choices that affect their state of health. Individuals have options whether to do physical activity, taking care of themselves, and eat a balanced diet. Therefore, for those who are conscious of taking responsibility for their health, fitness apps are one of the initiatives individuals could take to make a better healthy lifestyle such as helping the users to manage and track their exercise activity, schedule exercise and control the intake of food they consume via the apps. As a result, individuals' general health and wellbeing are significantly impacted by their own decisions.

#### **ii) Living life without disease and illness are important**

Living a life free of disease and illness is important because it allows people to experience to have best possible physical health and gives people freedom to carry out their daily activities without limitations. Therefore, Fitness apps are a desirable choice for those who place a high priority on their health due to their ability to create personalised fitness plans, goals setting, track progress and many more. As a result, by keeping and maintaining health conditions individuals can save more money on the healthcare costs and reduce the risk of developing chronic illness.

#### **iii) Individuals health are depending on how well they take care themselves**

Individuals are in charge of managing their own health including taking initiative to be productive to stay fit and prevent chronic illness. In connection with that, fitness apps can help by providing accessibility by allowing users to access physical activity routines and health information anytime, even anywhere. By proactively managing their own health, individuals could have lower chances to be diagnosed with chronic illness and also enhance their general healthiness.

## **5.4 Hypothesis 4**

Hypothesis 4 shows that there is a significant positive association between Dietary Culture and Intention to Use Fitness Apps. This finding is due to the following reasons:

### **i) Eat variety of foods within recommended intake**

Eating a variety of food within the recommended amounts is important to keep a healthy and balanced diet. Different foods contain different nutrients such as proteins, carbohydrates, vitamins and minerals. By eating a variety of foods an individual can get all the nutrients that the body needs to function at its best. Fitness apps frequently concentrate on helping users to achieving their fitness goals such as losing weight, increasing muscle and decreasing body fat. Users can achieve their goals by consuming the necessary nutrients within recommended intake by the fitness apps.

### **ii) Physically active everyday**

Being physically active every day is important for individual general well-being and health and fitness apps can be very helpful in motivating and monitoring users' physical activities. Fitness apps come out with a way to tracking people's daily physical activity and setting goals. Fitness apps frequently provide features such as progress tracking, notifications and reminders to help users to stay liable and motivated. Overall, utilising fitness apps allows users to track their workout levels, set goals and help to stick to a regular exercise physical routine.

### **iii) Maintain body weight**

Being overweight can make people easily feel exhausted and have less energy. By maintaining a body weight, the body are able to function properly which can boost energy levels and overall vitality. Fitness apps can be helpful tools in maintaining the body by providing guidance, monitoring progress and encouraging motivation. Therefore, fitness apps can help users to maintain their ideal weight and healthy weight.

## 5.5 Suggestion for Future Studies

The findings of this study have been able to provide significant information and valuable insights to influence the intention to use fitness apps among generation Z. However, there is lots of potential to develop future studies that can be made based on these findings. Because respondents in this study were all members of generation Z using fitness apps and their ages ranged from 10 to 25, it would be beneficial in expanding the scope of this research to include the respondents from different age groups and demographics. Future studies can be extended to other generations such as generation X, generation Y, and generation W.

To expand on this study, future studies should focus on other types of fitness apps. It can focus on Health Monitoring Technology. This is because such technology is able to monitor a person's health factors. For example, fitness trackers that work in tracking people's daily activities. It is able to monitor heart rate, blood oxygen and so on. In addition, it also serves as a medication reminder which is very important in health management. It helps in remembering to take medicine on time. For example, the Mango Health app which is an application in helping to set medicine reminders at the right time. Besides, health monitoring technology also serves as a continuous surveillance monitor for fall detection capable of tracking patients and alerting healthcare professionals to incidents such as falls.

Furthermore, Emergency Monitoring Technology can also be focused on in future studies. This type of technology is a medical alert system that provides emergency monitoring inside and outside the home. It helps ensure personal safety to stay safe. This technology works to provide an immediate emergency signal in calling emergency medical personnel. For example, an emergency wristband which serves to protect a person during an emergency by providing accurate health information. The bracelet can help someone who is incapacitated or unable to explain all the medical details during an emergency. It's a silicone wristband with a button that connects to a home or mobile medical alert system. The middle button is called the help button. The bracelet uses sensors known as accelerometers, which can detect movement, to know when someone has fallen. It then notifies the monitoring centre for medical alerts that the individual needs help.

Lastly, future studies can also focus on other types of fitness applications such as Security Monitoring Technology. This technology works to track security related activities. With cyber security alerts, it allows individuals to act quickly and protect themselves from harm. It includes warning and alarm technology which is a security alarm that can detect an intrusion, such as unauthorised entry into a building or home. Security alarms protect against theft or property

damage. For example, a smart alarm that works as an intruder detection system in monitoring and security is easier. This system can monitor a person's home remotely and provide instant alerts if something happens.

## **6. CONCLUSION**

This study was aimed to discover the factors influencing the intention to use Fitness Apps among Generation Z. The study employs the non-probability selection approach of purposive sampling to survey a total of 130 respondents who use different types of Fitness Apps. The data collected was analysed using frequency, descriptive statistics, Cronbach's alpha, and Pearson correlation analysis with the aid of IBM SPSS Statistics version 25 software. The findings of this study reveal that perceived usefulness, perceived ease of use, health consciousness, and dietary culture have significant associations with intention to use fitness apps among generation Z. In conclusion, the findings of this study can be used as a guide for Fitness Apps companies and academics looking to understand further the influence of intention to use fitness apps among Generation Z.

As with other studies, this study has a few limitations. The primary limitations in this study is that researchers solely focus on Generation Z. Therefore, the data collected to obtain information and opinions from respondents via the 5-point likert scaling questionnaire becomes limited and weak. It is probably because the degree of response in relation to the intention to use fitness applications is relatively low, and the health condition of generation Z is not very high compared to other generations, such as baby boomers, generation X or millennials who face serious health risks. However, there are limitations to other generations that do not meet the specific characteristics required by the researchers to fill out the questionnaire. Furthermore, not all respondents between the ages of 10 and 25 are capable to utilize the fitness applications to track their health status. As a result, they employ physical exercise programs that do not require purchase or merely charge an entrance fee of RM 20.00, similar to a gymnasium service.

The next limitation of the study is the data collection method. In this study, the researchers used an online survey consisting of more than 5 question items for each independent variable and dependent variable. So, it is possible that the respondents did not read the questions completely and simply put the scale at random because it took a long time to answer the questionnaire. Thus, leading to possible sampling bias. Furthermore, when using quantitative research methods, it involves a structured questionnaire with closed-ended questions. As a result, when answering the questionnaire, the options for responses are limited due to the selection of answers based on the 5-point likert scaling. Future studies can perform both quantitative and qualitative methods to give

room for additional factors that could influence intention to use fitness apps among generation Z other than the factors examined in this study.

## REFERENCES

- Acikgoz, F., Filieri, R., & Yan, M. (2022). Psychological predictors of intention to use fitness apps: The role of subjective knowledge and innovativeness. *International Journal of Human-Computer Interaction*, 1-13.
- Ahn, T., Suh, Y. I., Lee, J. K., & Pedersen, P. M. (2014). *Understanding purchasing intentions in secondary sports ticket websites. International Journal of Sports Marketing and Sponsorship*.
- Akter, M., Sadekin, M. N., & Patwary, A. K. (2020). An Empirical Study on Students' Satisfaction from Mawlana Bhashani Science & Technology University, Bangladesh. *Review of Economics and Development Studies*, 6(2), 363-379.
- Al Mahmud, S. R. (2020). The effectiveness of Facebook advertisements on purchase intention of customers in Malaysia. *South Asian Journal of Social Sciences and Humanities*, 1(1), 97-104.
- Alom, S., Patwary, A. K., & Khan, M. M. H. (2019). Factors affecting the turnover intention of Bangladeshi migrants in the United Arab Emirates: An empirical study on the hotel industry. *International Journal of Innovation, Creativity and Change*, 8(3), 344-360.
- Angosto, S., García-Fernández, J., Valantine, I., & Grimaldi-Puyana, M. (2020). *The intention to use fitness and physical activity apps: a systematic review. Sustainability*, 12(16), 6641.
- Becker, M. H., Maiman, L. A., Kirscht, J. P., Haefner, D. P., & Drachman, R. H. (1977) The health belief model and prediction of dietary compliance: a field experiment. *Journal of Health and Social Behaviour*, 18, 348-366
- Beldad, A. D., & Hegner, S. M. (2018). Expanding the technology acceptance model with the inclusion of trust, social influence, and health valuation to determine the predictors of German users' willingness to continue using a fitness app: A structural equation modeling approach. *International Journal of Human-Computer Interaction*, 34(9), 882-893.
- Bernamea. (2021, November 11). *Kesedaran penjagaan kesihatan masih rendah di Malaysia*. New Straits Times. Retrieved from <https://www.hmetro.com.my/mutakhir/2021/11/776183/kesedaran-penjagaan-kesihatan-masih-rendah-di-malaysia>
- Chen, M. F., & Lin, N. P. (2018). Incorporation of health consciousness into the technology readiness and acceptance model to predict app download and usage intentions. *Internet Research*.
- Chiu, W., & Cho, H. (2020). The role of technology readiness in individuals' intention to use health and fitness applications: a comparison between users and non-users. *Asia Pacific Journal of Marketing and Logistics*.
- Cho, H., Chi, C., & Chiu, W. (2020). Understanding sustained usage of health and fitness apps: Incorporating the technology acceptance model with the investment model. *Technology in Society*, 63, 101429.



- Creswell, J. (2002). *Educational research: Planning, conducting, and evaluating quantitative and qualitative research*. Upper Saddle River, NJ: Merrill Prentice Hall.
- Damberg, S. (2021). Predicting future use intention of fitness apps among fitness app users in the United Kingdom: the role of health consciousness. *International Journal of Sports Marketing and Sponsorship*.
- Davis, F. D. (1989). Perceived usefulness, perceived ease of use, and user acceptance of information technology. *MIS quarterly*, 319-340.
- Dong, Z., Pan, W., Hu, A., & Ma, W. (2022). Explaining Chinese citizens' intention to use fitness applications under a national fitness policy: a technology acceptance model perspective. *Advances in Economics and Management Research*, 2(1), 54-54.
- Fengmin, Z., Bajjun, W., Jiangtao, B., Li, L., & Patwary, A. K. (2022). Investigating revisit intention of medical tourists in China through nutritional knowledge, perceived medical quality, and trust in the physiologist: A recommendation on health tourism policy measures. *Frontiers in Public Health*, 10, 893497.
- García-Fernández, J., Gálvez-Ruiz, P., Grimaldi-Puyana, M., Angosto, S., Fernández-Gavira, J., & Bohórquez, M. R. (2020). The promotion of physical activity from digital services: Influence of e-lifestyles on intention to use fitness apps. *International Journal of Environmental Research and Public Health*, 17(18), 6839.
- Gómez-Ruiz, A. A., Gálvez-Ruiz, P., Grimaldi-Puyana, M., Lara-Bocanegra, A., & García-Fernández, J. (2022). Investigating the intention to use fitness app: the role of the perceived attractiveness of fitness center customers. *Sport, Business and Management: An International Journal*.
- Hair, J. F., Risher, J. J., Sarstedt, M., & Ringle, C. M. (2019). When to use and how to report the results of PLS-SEM. *European business review*, 31(1), 2-24.
- Harian, W. S. (2020, February 21). Ubah gaya hidup lebih sehat. Sinar Harian. Retrieved from <https://www.sinarharian.com.my/article/70967/bisnes/ubah-gaya-hidup-lebih-sihat>
- Hazbar, A. M. H., Alem Mohammed, A., & Karim, A. K. A. (2019). An Empirical Study of Factors Influencing hotel customers' online booking Intention. *مجلة العلوم التربوية و الدراسات الإنسانية*, (5), 1-17.
- Iqbal, J., Yu, D., Zubair, M., Rasheed, M. I., Khizar, H. M. U., & Imran, M. (2021). Health consciousness, food safety concern, and consumer purchase intentions toward organic food: The role of consumer involvement and ecological motives. *SAGE Open*, 11(2), 21582440211015727.
- Koo, H. C., Poh, B. K., Lee, S. T., Chong, K. H., Bragt, M. C., Abd Talib, R., & SEANUTS Malaysia Study Group. (2016). Are Malaysian children achieving dietary guideline recommendations? *Asia Pacific Journal of Public Health*, 28(5\_suppl), 8S-20S.
- Lee, P. (2014, January 16). Malaysia is fattest country in South-East Asia. Retrieved from: <https://www.thestar.com.my/News/Nation/2014/01/16/Scoring-badly-on-dietary-habits-Malaysia-is-fattest-country-in-SE-Asia/>
- Leech, K. A., Roemmich, R. T., Gordon, J., Reisman, D. S., & Cherry-Allen, K. M. (2022). Updates in motor learning: implications for physical therapist practice and education. *Physical Therapy*, 102(1), pzab250.

- Li, L., Ragavan, N. A., Patwary, A. K., & Baijun, W. (2022). Measuring patients' satisfaction toward health tourism in Malaysia through hospital environment, nutritional advice, and perceived value: A study on Chinese exchange students. *Frontiers in public health*, 10, 893439.
- Li, L., Wu, B., & Patwary, A. K. (2022). How marine tourism promote financial development in sustainable economy: new evidences from South Asia and implications to future tourism students. *Environmental Science and Pollution Research*, 29, 1155-1172.
- Li, L., Wu, B., & Patwary, A. K. (2022). The psychosocial factors affecting chinese Outbound Exchange and mobility students' academic performance during COVID-19. *Frontiers in psychology*, 13, 872516.
- McCombes, S. (2019). *Research Design: Types, Methods, and Examples*
- Oyibo, K., & Vassileva, J. (2020). Persuasive Features that Drive the Adoption of a Fitness Application and the Moderating Effect of Age and Gender. *Multimodal Technologies and Interaction*, 4(2), 17.
- Park, J., Ahn, J., & Yoo, W. S. (2017). The effects of price and health consciousness and satisfaction on the medical tourism experience. *Journal of Healthcare Management*, 62(6), 405-417.
- Patwary, A. K., Roy, B., Hoque, R., & Khandakar, M. S. A. (2019). Process of developing a community based tourism and identifying its economic and social impacts: An Empirical study on Cox's Bazar, Bangladesh. *Pakistan Journal of Humanities and Social Sciences*, 7(1), 1-13.
- Sanusi, G. A. (2020). Factors Influencing the Intention to Use Malaysian Dietary Guidelines Among University Students. *International Journal of Economics, Management and Accounting*, 28(2), 517-543.
- Saunders, M., Lewis, P. and Thornhill, A. (2012) *Research Methods for Business Students*. Pearson Education Ltd., Harlow.
- Sekaran, U., & Bougie, R. (2016). *Research Methods For Business: A Skill Building Approach* (7th ed.). United Kingdom: John Wiley & Sons Ltd
- Shamsuri, A. S. (2022, January 24). Malaysia negara paling tinggi obes di Asia Tenggara. *Kosmo Digital*. Retrieved from <https://www.kosmo.com.my/2022/01/24/malaysia-negara-paling-tinggi-obes-di-asia-tenggara/>
- Stopa, S. R., Szwarcwald, C. L., Oliveira, M. M. D., Gouvea, E. D. C. D. P., Vieira, M. L. F. P., Freitas, M. P. S. D., ... & Macário, E. M. (2020). National Health Survey 2019: history, methods and perspectives. *Epidemiologia e Serviços de Saúde*, 29, e2020315.
- Sumethokula, P., Patwary, A. K., Srinuanpanc, B., Srinuanpand, C., Suwandee, P., Thammathikul, A., & Phanong, W. (2020). The potential of new tour repackaging for creative tourism among entrepreneurs in Nakhon Si Thammarat. *International Journal of Innovation, Creativity and Change*, 13(10), 1752-1771.
- Suzuki, N., & Tachihara, S. (2014). Role of diet in sustaining the family and community ties social innovation design anchored on traditional dietary culture in Ngiwal, Republic of Palau. *Bulletin of Japanese Society for the Science of Design*, 61(1), 1\_7-1\_16

- The Star Newspaper. (2014, June 16). Malaysia's obesity rate highest in Asia. Retrieved from <http://www.thestar.com.my/News/Nation/2014/06/16/obesity-malaysia-highest-in-asiasays-pm-science-advisor/>
- The Star Online. (2020, June 1). Nutrition in Malaysia is bad. *Toronto Star*. Retrieved from <https://www.thestar.com.my/opinion/letters/2020/06/01/nutrition-in-malaysia-is-bad>
- Wu, B., Liu, S., Wang, J., Tahir, S., & Patwary, A. K. (2021). Assessing the mechanism of energy efficiency and energy poverty alleviation based on environmental regulation policy measures. *Environmental Science and Pollution Research*, 28, 40858-40870.
- Wu, B., Zhai, B., Mu, H., Peng, X., Wang, C., & Patwary, A. K. (2021). Evaluating an economic application of renewable generated hydrogen: A way forward for green economic performance and policy measures. *Environmental Science and Pollution Research*, 1-15.
- Yan, M., Filieri, R., Raguseo, E., & Gorton, M. (2021). Mobile apps for healthy living: Factors influencing continuance intention for health apps. *Technological Forecasting and Social Change*, 166, 120644.
- Yang, Y., & Koenigstorfer, J. (2021). Determinants of Fitness App Usage and Moderating Impacts of Education-, Motivation-, and Gamification-Related App Features on Physical Activity Intentions: Cross-sectional Survey Study. *Journal of medical Internet research*, 23(7), e26063.
- Yeong, A. (2022, August 16). *Khairy: A healthy lifestyle is ideal, but remains a challenge for most Malaysians*. Malay Mail. Retrived from <https://www.malaymail.com/news/malaysia/2022/08/16/khairy-a-healthy-lifestyle-is-ideal-but-remains-a-challenge-for-most-malaysians/23117>
- Yu, J. H., Ku, G. C. M., Lo, Y. C., Chen, C. H., & Hsu, C. H. (2021). Identifying the Antecedents of University Students' Usage Behaviour of Fitness Apps. *Sustainability*, 13(16), 9043.
- Zhang, X., & Xu, X. (2020). Continuous use of fitness apps and shaping factors among college students: A mixed-method investigation. *International journal of nursing sciences*, 7, S80-S87.

# **FAST FOOD CONSUMPTION AMONG UNIVERSITY STUDENTS: A COMPARATIVE STUDY BETWEEN UNIVERSITY MALAYSIA KELANTAN (UMK) PENKALAN CHEPA AND INSTITUT PENDIDIKAN GURU (IPG) STUDENTS**

*Siti Nur Syazwani Binti Mujayin, Nur Hidayah Binti Mohamed Zid, Muhammad Amirul Shahir Bin Mohd Jafri, Azma Hanis Binti Ab Wahab \* Dr. Mohd Hakam Bin Nazir*

*Faculty of Hospitality, Tourism and Wellness, University Malaysia Kelantan*

*Corresponding email: hakam.n@umk.edu.my*

---

## **ABSTRACT**

Through the participation of the University Malaysia Kelantan (UMK), Pengkalan Chepa, and Institute Pendidikan Guru (IPG), this study seeks to examine the comparative value of fast food among university students. When conducting this investigation, the researchers used quantitative techniques. To make communication between the researcher and the respondents easier while conducting this study, the questionnaire was made available to the respondents online. The purpose of this study is to determine whether factors such as social standing, the environment, and student lifestyles have an impact on college students' involvement in fast food eating.

**Keywords: fast food consumption among university students, social status, the environment, student lifestyles**

---

## **INTRODUCTION**

Saha (2018) defines fast food as a type of unhealthy food that has been chosen by most students. Fast food also refers to a higher intake of energy-dense food and can also expand the risk, especially for the health of the human body, such as weight gain. In addition, research by H. H. Al-Otaibi (2015) claims that, compared to when they were children or teenagers, college students are more likely to skip meals or eat out with friends. There is evidence that, throughout college years, consumption of nutritious foods, including fruits, vegetables, and milk, drops while consumption of fast-food soft beverages rises.

On the other hand, eating patterns change while technology is developing quickly. Although nutrition is important for all societal groups, university students give it a varied level of importance.

People start making decisions regarding their food habits and dining out more as they become more autonomous during this time and are influenced by their social circles (H. Darminci 2012).

There are three objectives in this research:

1. To examine the significant relationship between social status and fastfood consumption.
2. To determine the significant relationship between environmental factors and fast-food consumption.
3. To identify the relationship between student lifestyle and fast-food consumption among university students.

## **SIGNIFICANCE OF THE STUDY**

### **The main fact about fast food**

The main objectives of this study are to find out the main factors of fast-food favourites faced by university students, especially at University Malaysia Kelantan and Institute Pendidikan Guru.

### **HELP THE GOVERNMENT**

This study also helps the government improve the management of wellness. By doing this, the health of students will be guaranteed, especially in the future.

### **FUTURE RESEARCHERS**

This study will also help future researchers conduct more studies on the cause authority fastfood consumption between university students.

## **LITERATURE REVIEW**

### **Social status**

Fast foods are created quickly and are less expensive than other forms of food, according to the participants, who also found them to be generally accessible. In addition, the variety of tastes, aromas, and colors of fast foods was highlighted as factors driving the consumption of fast foods.

Some participants claimed that they ate fast food despite not wanting to because they felt that they had to keep up with their friends. They said things like, "When I am with my friends, if they invite me to go out to eat fast food, I won't deny the offer" (male, 21 years old)

According to a few participants, eating fast food makes teenagers feel modern and like they belong to a higher social class. (Bauer KW, Larson NI, Nelson MC).

### **The environment**

According to research, college is a crucial time for students to change their eating habits. University students are also more likely to have a bad diet intake. Students who first enroll in college frequently experience the strains of shifting academic burdens, attempting to adapt to their new environment, building networks, and taking on unexpected obligations. University students today have more flexibility and control over their lives than ever before, which can lead to poor nutritional decisions like a regular fast-food diet. It is possible that fast food culture among students will cause a demographic shift away from traditional foods and home-cooked meals

The reasons college students eat at fast food outlets have not been the subject of much research. Different sociodemographic characteristics, including age, sex, education, employment position, and household size, appear to have an impact on people's reasons for eating fast food. Food preferences can be influenced by a variety of factors, including advertising and media, a lack of parental supervision, taste preferences, self-control,

### **Student lifestyles**

College students in South Asia are increasingly engaging in unhealthy eating habits. Younger age, higher socioeconomic class, higher BMI (being overweight or obese), study groupings including Humanities students, lack of nutrition understanding, and internet addiction all played a part as favorable predictors of frequent fast-food consumption. Additionally, due to the flavor, brand reputation, accessibility, location, affordability, atmosphere, sanitation standards, variety, promotional offers, and quick service, college students consumed significantly more fast food (Md Abdullah et al,2021).

In addition, some of the people who are knowledgeable about nutrition, and who are skilled in food preparation also consume fast food in their diet due to lack of time and energy, academic stress, eating cravings, and more lax social norms, among other factors. (Malane et al,2014).

## Research Hypothesis

The researchers state the relationship between factors of fast-food consumption among university students. The relationship is divided into three components, which are social, the environment, and student lifestyle.

**H1:** there is a significant relationship between social factors and fast-food consumption among university students.

**H2:** there is a significant relationship between environmental factors and fast-food consumption among university students.

**H3:** There is a significant relationship between student lifestyle and fast - food consumption among university students.

## Research Framework

### INDEPENDENT VARIABLES

### DEPENDENT

### VARIABLES

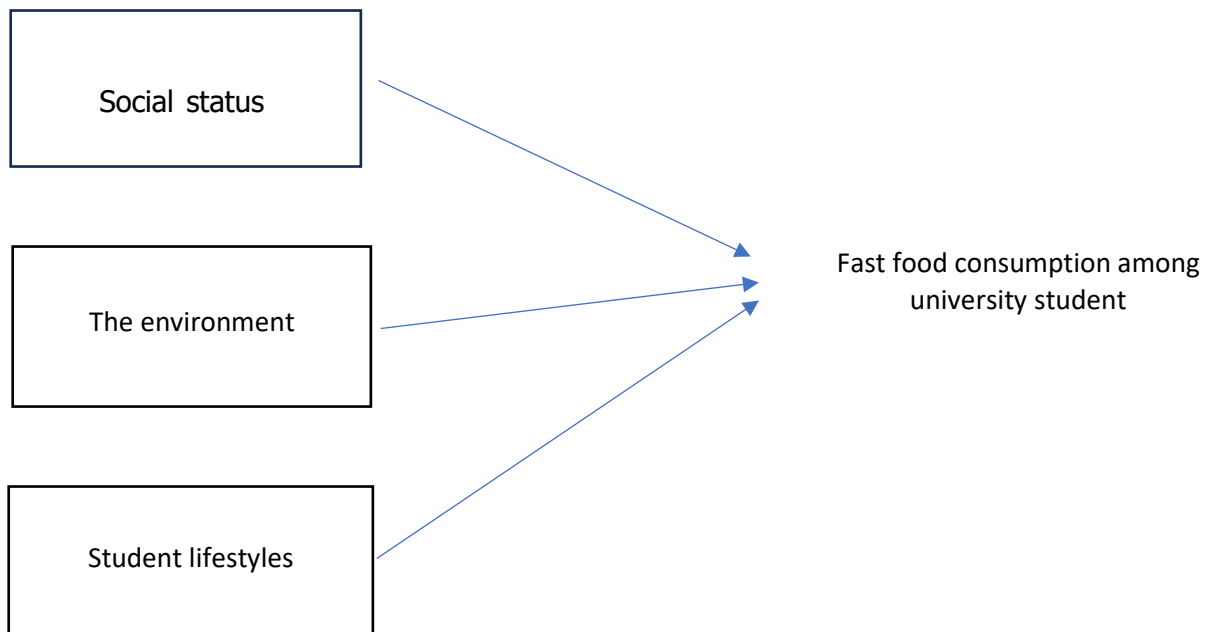

## **METHODOLOGY**

### **Research Design**

The method utilized to accomplish research goals or test hypotheses is known as a research design. In order to answer the research question, it is important to make sure that any proof obtained from the data can be used. The three fundamental research designs that can be used to illustrate how the researchers accomplish the research goals are exploratory, informal, and formal. Researchers can find out how the dependent variables in this method are university students and the independent factors, which are socioeconomic status, the environment, and student lifestyles. The researcher used the quotatives research technique to complete this study using the data that our group had gathered. In order to fill out the questionnaire, the researchers collected data from students at the University Malaysia Kelantan and the Pendidikan Guru.

### **Data Collection**

The questionnaire is the main method for data collection in this study. The researchers had chosen Google Forms because it can make it easier to distribute the questionnaire. This questionnaire was distributed specifically to students from the University Malaysia Kelantan and institute Pendidikan guru to find out their experiences with fast-food consumption.

### **Sampling**

Sampling is an academic method of collecting information to learn more about a specific population by examining the result of a sample of people rather than focusing on some individual

### **Data Analysis**

Data analysis is a technique used to examine records using logic, reasoning, and statistics. The data analysis is the statistical package for the social sciences. By using statistical software, researchers can select the most effective statistical technique to use. Statistics like the cumulative percentage and valid percentage will be explained by using SPSS data. The researchers also will use SPSS-created tables for data entry and analysis. Researchers can collect data for industry research in addition to performing descriptive, reliability, and correlation analyses.



## FINDINGS

### DESCRIPTIVE ANALYSIS

A simple descriptive coefficient is used in a descriptive analysis to summarize a particular set of data, which could be a sample of the complete population or a representative of that group. Just look at a student's grade point average to see an example of descriptive statistics in action (GPA).

Measures of variability include a standard deviation, variance, minimum and maximum variability, and skewness, whereas measures of central tendency include mean, median, and mode. Through the application of descriptive statistics, large amounts of data can be made simpler. Each descriptive statistic condenses a lot of data into a condensed space. 1

<b>Mean level</b>	<b>Level of agreement</b>
4.50 – 5.00	Strongly agree
3.50 – 4.50	Agree
2.50 – 3.50	Neutral
1.50 – 2.50	Disagree
1.00 – 1.50	Strongly disagree

## Gender

The gender distribution of a total of 223 respondents is shown in Table 4.1 below. The information was gathered through a questionnaire.

<b>GENDER</b>	<b>FREQUENCY (n)</b>	<b>PERCENTAGE (%)</b>
male	96	43
female	127	57
total	223	100

The table displays the gender distribution of all 223 respondents based on Figure 4.1 above. According to the table, there were 57 percent (n = 127) more female respondents than male respondents (n = 96), who made up 43 percent (n = 96). Because she is friendlier and simpler to approach than the male respondent, the female respondent is more well-liked, and they are prepared to put in the time to complete the questionnaire.

## Age

The below shows the age distribution of a total of 223 respondents collected with the questionnaire.

<b>AGE</b>	<b>FREQUENCY (n)</b>	<b>PERCENTAGE (%)</b>
19 to 21 years old	30	26.3
22 to 25 years old	123	54.9
26 and above	12	5.4
TOTAL	223	100

The highest rate of fast-food intake among university students at UMK and IPG among these three age groups is 26.3 percent (n=30) among those who are 19 to 21 years old. The age group between 22 and 25 has the second-highest percentage (54.9%) (n=123). Ages 26 and older account for the lowest percentage (n=12), which is 5.4%.

Because they are still in their teenage years, people aged 22 to 25 had the largest percentage. They typically prefer consuming fast food at this point to support their existence and reduce the cost of living in IPTA. Ages 26 and over, however, are the lowest since people at these ages typically loathe fast food because most of them are married.

**Marital Status**

Table 4.3 displays the distribution of marital status for a total of 223 respondents who were surveyed by information.

Table 4.3 Marital Status of Respondent

<b>MARITAL STATUS</b>	<b>FREQUENCY (n)</b>	<b>PERCENTAGE (%)</b>
Married	16	7.6
single	207	92.4
total	223	100

The percentage of respondents who were married is shown in the table. Significant disparities exist between single respondents and married respondents, with single respondents scoring 92.4 percent (n = 207) and married respondents scoring 7.6 percent (n = 16), respectively. Because they had more time to answer the questionnaire than respondents who reported being married, who were too busy with their families and other responsibilities, single respondents received the highest percentage and number of responses.

## Races

Table 4.4 shows the race distribution of the total of 223 respondents collected from data collection through the questionnaire.

Table 4.4 Races of respondent

<b>RACES</b>	<b>FREQUENCY (n)</b>	<b>PERCENTAGE (%)</b>
Malay	105	47.3
Chinese	27	12.1
Indian	29	12.9
Iban	3	1.3
<b>TOTAL</b>	<b>223</b>	<b>100</b>

Among these 4 groups of races, the high of percentage fast-food consumption among university students at UMK and IPG is Malay with 47.3 percent (n=105). The second highest is Indian with 12.9 percent (n=29). The third highest is Chinese with 12.1 percent (n=27). The lowest percentage is 1.3 percent (n=3) from Iban.

## Education Level

Table 4.5 shows the education level distribution of a total of 223 respondents collected through the questionnaire.

Table 4.5 Education Level of Respondent

<b>Education Level</b>	<b>FREQUENCY (n)</b>	<b>PERCENTAGE (%)</b>
Stpm/Stam	123	57.9
Diploma	45	20.1
Foundation	13	5.8
Matriculation	42	18.7
<b>TOTAL</b>	<b>223</b>	<b>100</b>

Among these 4 groups of education level, the high of percentage fast-food consumption among university students at UMK and IPG is STPM/STAM with 57.9 percent (n=123). The second highest is Diploma with 20.1 percent (n=45). The third highest is Matriculation with 18.7 percent (n=42). The lowest percentage is 5.8 percent (n=13) from Foundation.

### **Institution**

Table 4.6 shows the Institution distribution of a total of 223 respondents collected from data collection through the questionnaire.

Table 4.6 Institution of Respondent

<b>INSTITUTION</b>	<b>FREQUENCY (n)</b>	<b>PERCENTAGE (%)</b>
UNIVERSITY MALAYSIA KELANTAN (UMK)	165	73.7
INSTITUT PENDIDIKAN GURU (IPG) KOTA BHARU	58	25.9
<b>TOTAL</b>	<b>223</b>	<b>100</b>

Among these 4 groups of races, the highest percentage of fast-food consumption among university students is at UMK, with 73.7 percent (n = 165). The lowest percentage is 25.9 percent (n = 58) from IPG.

### **Years of Study**

Table 4.7 shows the Years of Study distribution of a total of 223 respondents collected from data collection through the questionnaire.

Table 4.7 Years of Study of Respondent

<b>YEARS OF STUDY</b>	<b>FREQUENCY (n)</b>	<b>PERCENTAGE (%)</b>
1 <sup>st</sup> Year	42	18.8
2 <sup>nd</sup> Year	30	13.4
3 <sup>rd</sup> Year	117	52.3
4 <sup>th</sup> Year	34	15.2
<b>TOTAL</b>	<b>223</b>	<b>100</b>

Among these 4 groups of Years of Study, the high of percentage fast-food consumption among university students at UMK and IPG is 3<sup>rd</sup> Year with 52.3 percent (n=117). The second highest is 1<sup>st</sup> Year with 18.8 percent (n=42). The third highest is 4<sup>th</sup> Year with 15.2 percent (n=34). The lowest percentage is 13.4 percent (n=30) from 2<sup>nd</sup> Year.

#### **4.2.8 Household/ Family Income Classification**

Table 4.8 shows the household and family income classification distribution of a total of 223 respondents collected from data collection through the questionnaire.

Table 4.8: Household and Family Income Classification of Respondents

<b>HOUSEHOLD/FAMILY INCOME CLASSIFICATION</b>	<b>FREQUENCY (n)</b>	<b>PERCENTAGE (%)</b>
B40	143	63.9
M40	61	27.3
T20	19	8.5
<b>Total</b>	<b>223</b>	<b>100</b>

Among these 4 groups of Years of Study, the high of percentage of fast-food consumption among university students at UMK and IPG is B40 with 63.9 percent (n = 143). The second highest is M40 with 27.3 percent (n = 61). The lowest percentage is 8.5 percent (n = 19) from T20.

## **DISCUSSION AND RECOMMENDATION**

The topic of fast-food consuming behavior amongst University of Malaysia Kelantan students and IPG students was examined in this study. Fast food consumption among college students is on the rise these days as it gains popularity among Malaysian students as well as those attending UMK and IPG. Chains of fast-food restaurants have grown quickly as a result of societal demand. This survey included 223 respondents in total. The results of this study's descriptive analysis, which was used to ascertain the respondents' eating habits, revealed that 77.5% of UMK students and 22.5% of IPG students consumed the fastest food. A little price factor of around 72% has an impact on fast food consumption patterns as well. It appears that 93% of the respondents enjoy eating fast food a lot. Only 5% of respondents bothered to read the nutrition labels before buying fast food. The findings also show that 99% of respondents, or the majority, frequently eat fast food 1–5 times each week. Over the past few decades, university students have consumed more fast food. Because they consume too many high calorie, fatty meals and have an imbalance between their energy intake and consumption, university students are now more likely to acquire cardiovascular disease and diabetes. The purpose of this study is to compare fast food consumption among students at Institute Pendidikan Guru (IPG) Kota Bharu and UMK Campus Kota. 223 respondents, including 165 UMK and 58 IPG students, received the questionnaire.

To gather data, it is advised to hand out the questionnaire physically or in person. This is because it is easier to convince respondents to take the time to fill out the questionnaire. Furthermore, respondents are prohibited from providing false information about gender, age, or race throughout the entire survey. Online and mobile survey incentives may encourage response fabrication. Since people could provide false demographic data to complete the questionnaire fast. Next, the questions must be reduced or written in a way that is simpler to understand. This is due to the researcher's examination that a small proportion of respondents do not comprehend the questions and opt not to respond.

The chi-square analysis of various demographic variables revealed a relationship between age and fast-food intake and pocket money. It demonstrates how variations in pocket money may impact the consumption of fast food. It also demonstrated that age also plays a key influence in college students' intake of fast food, demonstrating that those with greater disposable income are prone to consume more fast food. Contrary to popular belief, it has been discovered that college

students consume fast food regardless of gender or level of education. According to the literature, there are four independent variables that affect the dependent variable; nevertheless, the findings of the regression analysis showed that only the flavor and advertising of fast food had an impact on consumer behavior. Although much of the research argued that convenience and eating habits influence the consumption of fast food, this study finds that these characteristics are not as relevant as flavor and advertising.

## **CONCLUSION**

The good and negative consequences of fast-food eateries are amplified by their very existence. The beneficial effects it has can help to increase student possibilities, which will aid in the expansion of the national economy. One of the unfavorable consequences, meantime, is linked to a health problem that might cause weight difficulties in students, which can have an impact on academic performance. A healthy diet can aid in boosting the immune system now and in the future. In summary, society should inform those who enjoy fast food that they have a responsibility to limit their consumption. The demand for fast food goods is rising daily as a result of shifting lifestyles. This pattern is becoming more prevalent, especially among student fraternities. Considering such a perspective, the main objectives of this study was to resolve college students' dietary preferences for fast food items. Food preference is the study's dependent variable, and there are five independent factors. 223 respondents participated in the study that was done among UMK and IPG students. To evaluate the hypothesis, regression analysis, and chi-square testing were performed.

By understanding the effects of bad eating the current state of knowledge regarding the effects of unhealthy diet on adolescents was covered by fifteen studies (45.45%); impacts covered included those that result in obesity, hypertension, high cholesterol, intestinal cancer, cardiovascular disease, dental caries, etc.



## REFERENCES

- [https://www.researchgate.net/publication/301328040\\_AMERICAN\\_JOURNAL\\_OF\\_FOOD\\_AND\\_NUTRITION\\_Fast\\_food\\_intake\\_among\\_saudi\\_populationAlarming\\_fact](https://www.researchgate.net/publication/301328040_AMERICAN_JOURNAL_OF_FOOD_AND_NUTRITION_Fast_food_intake_among_saudi_populationAlarming_fact)
- [https://www.researchgate.net/publication/302972487\\_Does\\_neighborhood\\_fastfood\\_outlet\\_exposure\\_amplify\\_inequalities\\_in\\_diet\\_and\\_obesity\\_A\\_cross-sectional\\_study](https://www.researchgate.net/publication/302972487_Does_neighborhood_fastfood_outlet_exposure_amplify_inequalities_in_diet_and_obesity_A_cross-sectional_study)
- [https://www.researchgate.net/publication/319859456\\_Influences\\_of\\_Physical\\_Environments\\_on\\_University\\_Student\\_Eating\\_Behaviors](https://www.researchgate.net/publication/319859456_Influences_of_Physical_Environments_on_University_Student_Eating_Behaviors)
- [https://www.researchgate.net/publication/305714267\\_On\\_campus\\_food\\_purchasing\\_behaviours\\_preferences\\_and\\_opinions\\_on\\_food\\_availability\\_of\\_university\\_students](https://www.researchgate.net/publication/305714267_On_campus_food_purchasing_behaviours_preferences_and_opinions_on_food_availability_of_university_students)
- [https://www.researchgate.net/publication/278742572\\_Impulsivity\\_and\\_Fast-Food\\_Consumption\\_A\\_Cross-Sectional\\_Study\\_among\\_Working\\_Adults](https://www.researchgate.net/publication/278742572_Impulsivity_and_Fast-Food_Consumption_A_Cross-Sectional_Study_among_Working_Adults)
- [https://www.researchgate.net/publication/337494456\\_Factor\\_Affecting\\_the\\_Prevalence\\_of\\_Non-ideal\\_Body\\_Mass\\_Index\\_BMI\\_among\\_Female\\_University\\_Student](https://www.researchgate.net/publication/337494456_Factor_Affecting_the_Prevalence_of_Non-ideal_Body_Mass_Index_BMI_among_Female_University_Student)
- [https://www.researchgate.net/publication/363273611\\_A\\_Comparative\\_Study\\_on\\_Behavioral\\_Determinants\\_of\\_Fast-Food\\_Consumption\\_Behavior\\_among\\_Undergraduates\\_in\\_Kelantan\\_Malaysia](https://www.researchgate.net/publication/363273611_A_Comparative_Study_on_Behavioral_Determinants_of_Fast-Food_Consumption_Behavior_among_Undergraduates_in_Kelantan_Malaysia)
- [https://www.researchgate.net/publication/333672460\\_Assessing\\_the\\_nexus\\_of\\_fast food\\_consumption\\_and\\_childhood\\_obesity\\_in\\_Lahore\\_Metropolitan\\_City\\_of\\_Pakistan](https://www.researchgate.net/publication/333672460_Assessing_the_nexus_of_fast_food_consumption_and_childhood_obesity_in_Lahore_Metropolitan_City_of_Pakistan)

# **The factors that influence physical activity involvement among Universiti Malaysia Kelantan (UMK) Kampus Kota students**

**Kanageswary A/P Chantiran, Nur Hazwani Khairunnisa Binti Rosli, & Wan Adzilah  
Binti Wan Mohd Faris**

*Faculty of Hospitality, Tourism and Wellness, Universiti Malaysia Kelantan Corresponding email:*

[h20a1179@siswa.umk.edu.my](mailto:h20a1179@siswa.umk.edu.my), [h20a1526@siswa.umk.edu.my](mailto:h20a1526@siswa.umk.edu.my), [h20a1856@siswa.umk.edu.my](mailto:h20a1856@siswa.umk.edu.my)

---

## **ABSTRACT**

This study aims to find out the factors that influence the involvement of Universiti Malaysia Kelantan (UMK) Kampus Kota students in physical activity. There are several factors that influence student involvement in physical activity. The objective of this study is to determine whether psychological factors, environmental factors and intrinsic factors may influence student's involvement in physical activity. Physical activity provides many benefits to an individual's body. The researcher used quantitative methods when conducting this study. The questionnaire was distributed to the respondents online to facilitate the researcher and also the respondents when conducting this study. The selected respondents are students of Universiti Malaysia Kelantan Kampus Kota. The results of this study found that students' involvement in physical activities can improve their mental and physical health.

**Keywords:** Physical activity, physiological factors, environmental factors, intrinsic factors

---

## **INTRODUCTION**

Any physically taxing or competitive game, competition, or activity that is performed in accordance with rules for fun or as a job is considered a sport. The Council of Europe's definition of sport is inclusive and broad aside from that. According to the study, men are far less likely than women to achieve the ideal body type. In order to boost their sexual attraction, college students are provided with descriptions of their body types and beauty. Physical activity can help you have a slim or slender body shape and can also help you overcome social discomfort (Abdullah et al., 2021). The World Health Organisation (WHO) defines physical activity as any physiological movement involving energy expenditure from skeletal muscles. Any movement counts as physical activity, whether it's done for exercise, to go to and from work, or for other reasons. Physical activity is good for your health, whether it is moderate or vigorous. Common forms of exercise include playing, participating in sports, cycling, and wheeling. Anyone can engage in any of these activities, regardless of their degree of competence. The management and prevention of non-communicable diseases like diabetes, heart disease, stroke, and numerous cancers have both been demonstrated to be aided by regular exercise.

Another key tactic for guaranteeing participation is engaging in physical activity. Students' involvement in physical activity can promote health while also raising satisfaction

levels for everyone. Even though regular exercise has many health benefits, individuals in developing countries generally do not fully embrace a healthy culture. Exercise encourages a healthy lifestyle and builds self-esteem. In order to maintain excellent health and ward off health issues, both male and female students participate in physical activity. This shows that regular exercise is the best way to reduce your risk of contracting a non-communicable disease (Abdullah et al., 2021). The purpose of this study is to determine whether or not the elements have an effect on university students. Exercise is often recommended for university students because it offers so many advantages.

There are three objectives in this research:

1. To determine whether psychological factor may influence students' involvement in physical activity among Universiti Malaysia Kelantan (UMK) Kampus Kota students.
2. To determine whether environment factor may influence students' involvement in physical activity among Universiti Malaysia Kelantan (UMK) Kampus Kota students.
3. To determine whether intrinsic factor may influence students' involvement in physical activity among Universiti Malaysia Kelantan (UMK) Kampus Kota students.

## **SIGNIFICANCE OF THE STUDY**

### **Physiological**

Physiological research focuses on both behaviour and cognition (Brazier, 2018). The principles that support the mind, the brain, and behaviour are of great interest to scientists who study physiology. It includes immaterial items that are not visible to the naked eye, such as concepts, emotions, memories, dreams, experiences, and other things.

### **Environmental**

The meaning of the word "natural" as it is used in ordinary speech and dictionaries is the foundation for the definitions of these two ideas: natural environment and environmental change. The three terms environmental, land, and land degradation all refer to a change or disturbance to the land, the soil, or the environment that is judged harmful or undesirable (Johnson, 1997).

### **Intrinsic**

The value of life is increased by social interaction but reduced by isolation. Loneliness and a lack of purpose in life are incompatible. Their relationship to individually assembled measures of whole-brain functional connectivity revealed significant and recurrent patterns. Greater loneliness is associated with denser and fewer connections between the frontoparietal and default modules, attentional, and perceptual networks. Stronger inter-network connections are associated with poorer life meaning, while increased modular brain connectivity is associated with reduced levels of loneliness (Mwilambwe-Tshilobo, 2019).

## **LITERATURE REVIEW**

### **Physical Activity**

Any skeletal muscle-based movement of the body requiring the consumption of energy is referred to as physical exercise. All motions, whether they are made for fun, to get to and from other places, or as part of one's job, are considered to be a part of this physical activity. Moderate and strenuous physical activity both benefit the body's health.

Any movement of the body involving the skeletal muscles and requiring energy is considered physical exercise. Any movement is considered to be physical exercise, regardless of whether it is done for recreation, to get to and from places, or as part of a person's job. Non-communicable diseases like diabetes, heart disease, stroke, and a variety of cancers can all be treated and prevented with exercise, according to research. Additionally, it decreases blood pressure, improves quality of life, and promotes mental wellness (World, 2022). It also aids in maintaining a healthy body weight.

### **Physiological Factor**

Stress is an emotional and physical response to life's growing demands. Stress contributes to a multitude of physical and mental illnesses and makes some students feel anxious, helpless, angry, and guilty (Normaizatul Akma Saidi, 2019). The research revealed that participating in physical education classes helped students control the stress brought on by their coursework. (Al-Wadei, 2013). Exercise is intended to boost mood and lessen stress, which may help people realise how depression, stress, and health outcomes are connected. (2012) Hamer, M., Endrighi, R., and Poole.

A prevalent type of psychological anguish has a major impact on both daily social and physical functions. Even worse, it leads to impairments that are on par with those brought on by diabetes, hypertension, or arthritis. Independently, both joyful and unpleasant moods have an impact on longevity and physical health. Growing amounts of data support the positive biochemical and physiological effects of joy, happiness, pleasure, optimism, and sense of humour. Therefore, achieving happiness, overcoming long-term stress, and minimising negativity are key components of better health.

### **Environmental Factor**

Environmentally related health problems are complex and can result from a variety of factors, including an individual's genetic propensity to get a disease or other condition as reported by scientists (Biddle, 2018). Environmental health issues may be caused by biological, physical, or even financial factors. Environmental health problems can be influenced by the way our bodies function, the air we breathe, the water we drink, the food we consume, as well as the homes, buildings, and areas where we live and work.

Environmental considerations Our health is impacted by a number of environmental factors. This covers issues including increased computer use, air pollution, lead, pesticides, and food containing carcinogens. 2022) (Carolyn M. Hutter. Understanding environmental influences is necessary to comprehend genetics. Genes can change due to environmental

factors, which can lead to disease. The risk and onset of disease may be influenced by gene-environment interactions, or a complicated interplay between genes and environment.

### **Intrinsic Factors**

Your familiarity with the activity, your experience with it, your preferences for the activity, and more are internal factors that influence physical activity. Inner influence, which depends on your own thinking as well as the experience and knowledge you have, comes from within as opposed to being informed by others. Since it will have an impact on them, whether for the better or worse, each individual needs to pay special attention to this internal component. Because a person's desires might influence their decision-making, it is said that this is the case. Furthermore, everyone is entitled to their own beliefs, including those on physically demanding activities. Even if they are aware that physical activity, such as running, walking, and other comparable activities, offers many advantages, some people find it to be tiresome and despise it for that reason. While lower degrees of loneliness are related with more modular brain connectivity, stronger inter-network connections are associated with inferior life meaning (Mwilambwe-Tshilobo, 2019).

### **The relationship between physiological factor, environmental factor, and intrinsic factor that influence involvement physical activities among Universiti Malaysia Kelantan (UMK) Kampus Kota students.**

As a way to reduce stress, exercise is commonly advised. Exercise appears to increase good feelings while decreasing stress and other negative emotions. Prior studies, however, have demonstrated that when faced with stress and unpleasant emotions, people increase health-promoting habits like physical exercise and healthy food while lowering such behaviours when faced with positive feelings. Exercise is linked to better mood, less stress, and negative consequences on the hours that follow in a typical day. 22 January 2019 (Dana Schultchen).

According to scientists, environmental health issues are complicated and can be caused by a wide range of variables, including a person's genetic susceptibility to get a disease or another condition. Environmental health issues are complex and can be brought on by a number of things, such as a person's genetic propensity for certain diseases or other ailments, according to specialists.

It is widely acknowledged that maintaining a healthy lifestyle is necessary for the development of young people, therefore physical activity is essential. The multiple physical, psychological, aesthetic, and social benefits of regular engagement in sports or physical activity are now backed by a lot of evidence. It has been demonstrated that regular exercise enhances wellbeing overall, prevents sarcopenia and fragility, lowers the risk of contracting a number of chronic diseases, as well as depression and dementia. Because adults and the elderly are more likely to experience physical and psychological issues due to sedentary habits throughout childhood and adolescence, youth sports participation is highly regarded in society (Sáez, I. et al., 2021).

## Hypothesis

The independent variables for this study were those that affected physiological factor, environmental factor, and intrinsic factor in accordance with the conceptual framework. Three independent variables have been presented, and they are as follows. The dependent variables are the participation in physical activities.

H1: There is a positive relationship between physiological factor that influence the involvement physical activities among Universiti Malaysia Kelantan (UMK) Kampus Kota students.

H2: There is a positive relationship between environmental factor that influence the involvement physical activities among Universiti Malaysia Kelantan (UMK) Kampus Kota students.

H3: There is a positive relationship between intrinsic factor that influence the involvement physical activities among Universiti Malaysia Kelantan (UMK) Kampus Kota students.

## Conceptual Framework

The model below shows the variables that affect students at UMK Kampus Kota's involvement in physical activity. The topic of conceptual framework has been explained and addressed by numerous academics. It was advised to use a portion of a literature review as a research approach to look at the relationships between the physiological, environmental, and intrinsic components. These are the three independent variables that have been presented.

Independent variables

Dependent variables

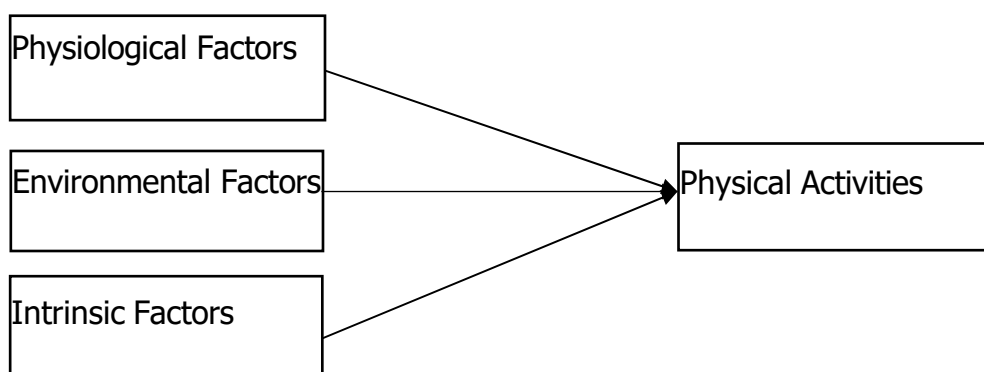

Source: (Khan Mamun, S. 2019)

Figure 1: Conceptual Framework of the relationship between factors that influence in physiological factor, environmental factor and intrinsic factor.

## **METHODOLOGY**

### **Research Design**

The method utilised to accomplish research goals or test hypotheses is known as a research design. In order to answer the research question, it is important to make sure that any proof obtained from the data can be used. The three fundamental research designs that can be used to illustrate how the researcher meets the research objectives are exploratory, descriptive, and causal. Physical activity is the dependent variable in this method, and researchers can learn about the relationship between independent variables such as physiological parameters, environmental factors, and intrinsic factors. The researcher used quantitative research techniques to carry out this investigation. Students at UMK Kampus Kota who responded to a questionnaire provided the researcher with information.

### **Data Collection**

Data collecting is a method for gathering information from the outside world to answer research questions, test hypotheses, and evaluate the outcomes. There are two different approaches to gathering data. Both primary and secondary data are gathered. The 364 respondents will receive the questionnaire online using Google Forms, which was employed as the main data collection tool for this study. The study will be carried out online by the researchers utilising a Google Form. The questionnaires will be distributed to UMK Kampus Kota students via social media channels like Twitter, Facebook, Telegram, and WhatsApp. An online survey with four-point Likert scale evaluations for each issue will be used to collect the data. Information and data are obtained for this project through both primary

### **Sampling**

By looking at the findings of a sample of people rather than concentrating on a small group of individuals, sampling is a method used in academia to gather data and learn more about a certain population (Turner, 2020). This study used both probability sampling and non-probability sampling, the two main sampling techniques. By using random samples, probability sampling enables judgements about the overall demography. 2020 (Stratton). Non-probability sampling commonly has an impact on qualitative research as well as the construction of research papers (Taherdoost, 2016).

In this investigation, a non-probability strategy, such as a straightforward sampling procedure, was used to select the sample design. For this study, simple random sampling will be used. There are the most samples available. A table of random numbers is then used to select the units. This method will enable the researcher to choose a random respondent and get particular data from each participant. Through the use of facility sampling, a non-probability or non-random sampling technique, people of a target demographic who meet the conditions, such as easy accessibility, geographic location, capacity at a specific time, or want to participate, will be included in the study (Etikan et al., 2016.).

## Data Analysis

Using logic, reasoning, and statistics to investigate records is a process known as data analysis. The Statistical Package for the Social Sciences is a tool for data analysis. Researchers can choose the best statistical methods to employ using SPSS software. We will use SPSS data to discuss statistics like the cumulative percentage and valid percentage. For data entry and analysis, the researcher will make use of tables prepared using SPSS. In addition to conducting descriptive, reliability, and correlation studies, researchers might gather data for industry research.

## FINDINGS

### Result of Frequency Analysis

Table 1: Demographic Profile of Sample

Characteristics		Frequency (N)	Percentage (%)
Gender	Male	225	61.8
	Female	139	38.2
Age	18-21 years old	56	15.4
	22-25 years old	255	70.1
	26-29 years old	43	11.8
	30 years old and above	10	2.7
Race	Bumiputra Sabah	2	5
	Bumiputra Sarawak	1	3
	Chinese	72	19.8
	Christian	1	3
	Indian	71	19.5
Faculty	Malay	217	59.6
	FHPK	154	42.3
	FKP	133	35.5
	FPV	49	13.5
Year of Study	FSDK	28	7.7
	Year 1	45	12.4
	Year 2	80	22.0
	Year 3	166	45.6
	Final Year (Year 4&5)	73	20.1

The frequency analysis of the respondents' responses is shown in the table above. Students from Universiti Malaysia Kelantan (UMK) Kampus Kota are the subject of the study. Male respondents made up 225 of the total respondents, or 61.8%, while female respondents made up 139 of the total respondents, or 38.2%.

In addition, the majority of respondents (255, or 70.1%) were between the ages of 22 and 25. Next, 56 respondents, or 15.4%, were between the ages of 18 and 21. With 43 respondents, the average age group is 26 to 29 years old (11.8%). While the lowest percentage of respondents—10—belonged to the 30-year-old and older age group (2.7%).



Additionally, the respondents were separated into six groups according on their race: Chinese, Christian, Indian, Malay, Bumiputra Sabah, and Bumiputra Sarawak. According to the poll, 59.6%, or 217 respondents, of the respondents who participated in this questionnaire were Malay. Chinese responses made up 19.8%, or 72 people, which was the second-highest percentage. Indian respondents made up 19.5% of all respondents, or 71 people, ranking third. Bumiputra Sabah has the second-lowest response rate at 0.5%, or 2 responders. The remaining respondents, who are Bumiputra Sabah and Christians and make up 0.3% of the total, were all in the same percentage.

The faculty from this questionnaire was separated into 4 groups, namely FHPK, FKP, FPV, and FSDK. Therefore, FHPK, which has 154 respondents and a 42.3% response rate, made up the majority of the respondents who took part in this survey. The FKP survey, which had 133 respondents, had the second-highest rate at 36.5%. With 49 respondents, or 13.5% of the total, FPV has the third-highest percentage of students' faculty. FSDK, which had 28 responders and a 7.7% response rate, has the fewest respondents among faculty.

The third-year students have the highest percentage, with 45.6% equivalent to 166 respondents, according to the chart above, while first-year students have the lowest percentage, with 12.4% equal to 45 respondents. Between them, students in their second year (years 2 and 3) at 22.0% had 80 responses, while those in their final year (years 4 and 5) at 20.1% had 73 replies.

## Result of Descriptive Analysis

Table 2 shows the result of descriptive analysis of variable.

Table 2: Descriptive Analysis

Variable	Items	Mean Score	Standard Deviation
<b>Physiological Factor</b>	The pressure can make my performance better.	2.99	1.368
	I have trouble relaxing and hard to sit still before the exercise or tournament start.	3.44	1.147
	I become annoyed and irritable during the tournament or exercise.	3.41	1.211
	I have negative thought patterns during tournaments, exercise, or training.	3.30	1.126
	I feel down or depressed after watching opponent the tournament and training.	3.41	1.215
	After the tournament, training, or exercise, I had trouble sleeping at night.	3.05	1.164
<b>Environmental Factor</b>	The hot temperature affects me during tournaments, training, or exercise.	3.90	0.933
	The sudden change of temperature will cause me sick during tournaments, exercise, or training.	3.80	0.972
	The cold temperature affects me during tournaments, training, or exercise.	3.62	0.971
	The change in temperature affects my focus	3.74	0.898

	and concentrate on exercise or tournament.		
	The high Altitude affects me during my tournament, exercise, or training.	3.69	0.910
	High altitude makes me fatigue or lose energy easily.	3.66	0.900
<b>Intrinsic Factor</b>	There is no fitness Centre that I could get into.	3.21	1.156
	I have no exercise equipment at home that I use.	3.48	1.110
	My family or friends do not encourage me to exercise.	3.11	1.215
	My parents give academic success priority over exercise.	3.40	1.185
	I have no leisure time for exercise because of my busy lesson schedule.	3.46	1.091
	I have no leisure time for exercise because of my social and family responsibilities.	3.27	1.160
<b>Physical Activity</b>	I've been thinking about exercise is difficult and too tiring.	3.39	1.176
	I have no energy as much as to be able to do exercise.	3.38	1.137
	I've been thinking about other recreational activities with my friends are more entertaining than exercise.	3.48	1.112
	I have not been thinking about exercise has positive effects on my health.	3.06	1.236
	I've been worried about my looks when I exercise.	3.40	1.095
	I have not been thinking about my ability to exercise.	3.41	1.111

Research investigating the mean and standard deviation for the physiological element, the independent variable. The maximum mean value was 3.44, and the majority of respondents concurred that the statement, "I find it difficult to unwind and sit still before an exercise or tournament starts," is the physiological factor that has the greatest impact on students at University Malaysia Kelantan (UMK) Campus Kota.

The mean and standard deviation are included in the study of the independent variable, environmental component. The maximum mean value was 3.90, and the majority of respondents concurred that the statement "The hot temperature affects me during tournaments, training, or exercise" was the most significant one regarding mental health and how environmental factors affect students at University Malaysia Kelantan (UMK) Kampus Kota.

The mean and standard deviation are included in the analysis of the independent variable, intrinsic factor. The maximum mean value was 3.48, and the majority of respondents concurred that the statement "I have no exercise equipment at home that I use" was the intrinsic factor with the greatest influence on students at University Malaysia Kelantan (UMK) Kampus Kota.

The mean and standard deviation are also included in the study of the physical element, the dependent variable. The maximum mean value was 3.48, and the majority of respondents concurred that it was "I've been thinking about other recreational activities with my friends are more entertaining than exercise." that had the greatest influence on students at University Malaysia Kelantan (UMK) Kampus Kota's participation in physical activity.

## Result of Reliability Test

Table 3 shows the result of reliability analysis based on dependent and independent variable.

Variable	Number of items	Reliability Cronbach's Alpha	Internal consistency
Physiological factor	6	0.899	Very good
Environmental factor	6	0.876	Very good
Intrinsic factor	6	0.894	Very good
Physical activity	6	0.921	Excellent

Table 3: Reliability Test

The tables above show the Cronbach's Alpha Coefficient values for the study's dependent variable (physical activity) and independent variables (physiological factor, environmental factor, and intrinsic factor). The tables show that the dependent variable and all independent factors were all over 0.7. As a result, the questionnaire has been approved and is legitimate. Six questions were utilised in this study to assess the Physiological Factor variable that affects University Malaysia Kelantan (UMK) Kampus Kota students' participation in physical activity. The table reveals that the Physiological Factor's Cronbach's alpha coefficient is 0.899, indicating a very strong level of connection. As a result, the coefficient found for the Physiological Factor Variable questions is accurate.

Next, six questions were utilised to assess the environmental factor variable that affects students at University Malaysia Kelantan (UMK) Campus Kota's participation in physical activity. The table reveals that the environmental factor's Cronbach's alpha coefficient is 0.876, indicating a very strong degree of connection. As a result, the coefficient found for the Environmental Factor variable's questions is accurate.

Last but not least, six questions were utilised to assess the intrinsic factor variable that affects students at University Malaysia Kelantan (UMK) Campus Kota's participation in physical activity. The table demonstrates that the intrinsic factor's Cronbach's alpha coefficient is 0.894, indicating a very strong degree of association. As a result, the coefficient found for the variables relating to the intrinsic factor is reliable.

The physical activity variable was lastly measured using six questions. The chart reveals that Physical Activity has an outstanding strength of association with a Cronbach's alpha coefficient of 0.921. The coefficient found for the questions related to the physical activity variable is therefore accurate.

## Pearson Correlation

Finding the linear relationship between the two variables required careful consideration of Pearson's correlation analysis. The purpose of this study was to look into potential

connections between the dependent variable (physical factor) and the independent variables (physiological factor, environmental factor, and intrinsic factor). The Pearson Correlation Analysis may be seen in the table below.

Table 4: Pearson Correlation Analysis

Hypothesis	Correlation coefficient (r)	P value	Strength of association	Result (Supported/Not Supported)
There is a significant relationship between physiological factor and physical activities among Universiti Malaysia Kelantan (UMK) Kampus Kota students.	0.765	0.001	Strong	H <sub>1</sub> is supported.
There is a significant relationship between environmental factor and physical activities among Universiti Malaysia Kelantan (UMK) Kampus Kota students.	0.418	0.001	Moderate	H <sub>2</sub> is supported.
There is a significant relationship between intrinsic factor and physical activities among Universiti Malaysia Kelantan (UMK) Kampus Kota students.	0.795	0.001	Strong	H <sub>3</sub> is supported

Results of the Pearson Correlation study are shown in the table above. There is an association between physiological variables and physical activity for the H1. The correlation coefficient of 0.765 obtained from the results shows that the link is very favourable. The physiological factor associated with physical activity has a p value of 0.001, which is below the highly significant level of 0.01. H1 has therefore been approved.

The relationship between environmental conditions and physical exercise is also good for the H2. With a correlation coefficient of 0.418, the findings show a somewhat good association. The physiological factor associated with physical activity has a p value of 0.001, which is below the highly significant level of 0.01. H2 has consequently been approved.

The last finding for the H3 is that environmental factors and physical activity are positively correlated. According to the findings, the link is very strong, with a correlation coefficient of 0.793. The physiological factor associated with physical activity has a p value of 0.001, which is below the highly significant level of 0.01. H3 has consequently been approved.

## DISCUSSION AND RECOMMENDATION

The discussion aims to answer the queries and address the hypothesis presented in the study's first chapter. In general, this study has thoroughly examined the variables that affect students at Universiti Malaysia Kelantan (UMK) Kampus Kota's involvement in physical exercise. The results led H1 to the conclusion that physiological parameters and physical exercise have a favourable association. This study demonstrates that physical activity and physiological factors have a beneficial relationship. The findings indicated that taking part in physical education sessions helped pupils better manage the stress caused by their assignments. Exercise is meant to elevate mood and ease stress, which may help people comprehend how stress, depression, and health consequences are related (Hamer, M., Endrighi, R., and Poole, L., 2012).

The results led H2 to the conclusion that environmental influences and physical activity are positively correlated. This study establishes a link between environmental factors and physical activity that is favourable. Environmental factors have an impact on a person's ability to engage in physical activity. Our health is impacted by a number of environmental factors. Carcinogens in food, increased computer use, pesticides, lead, and air pollution are a few of these (Carolyn M. Hutter, 2022). It follows that environmental influences have an impact on pupils' participation in physical activity.

Furthermore, based on the results, H3 came to the conclusion that environmental influences and physical activity are positively correlated. This study demonstrates a beneficial relationship between intrinsic variables and physical activity. Even if they are aware that regular exercise, like jogging or walking, has many benefits, some people dislike it because they find it to be exhausting. While lower degrees of loneliness are related with more modular brain connectivity, stronger inter-network connections are associated with inferior life meaning (Mwilambwe-Tshilobo, 2019). Thus, it can be said that intrinsic factors have an impact on students' participation in physical activity.

Every research project must have some kind of barrier or restriction, and this study is no different. The researchers found it challenging to complete this investigation due to its restrictions. This study has three limitations: a lack of cooperation, a time crunch, and the challenge of finding an excellent and pertinent literature review. In order to better comprehend research challenges, the main objective of the research study is to analyse and present the results of the data analysis from the previous chapter. Physical activity and the independent variables of physiological, environmental, and intrinsic factors are correlated, according to the research.

The questionnaire for subsequent studies should be made simpler and clearer to grasp, as the first recommendation. This is due to the fact that respondents always react to surveys without reading or comprehending the sentences. Because of the respondents' positive responses, the outcomes may also be more useful. The second recommendation is to upgrade tools and facilities to benefit pupils. This is so because the physiological, environmental, and internal elements that determine physical activity the subject of this study are already well-known.

## CONCLUSION

In conclusion, research has been done to identify the variables that affect students at Universiti Malaysia Kelantan (UMK) Kampus Kota's involvement in physical activity. The dependent variable, which is the level of physical activity among students at UMK Kampus Kota, has three independent variables: a physiological factor, an environmental factor, and an intrinsic factor. The Pearson Correlation Coefficient was used to assess these independent and dependent variables. This demonstrates that the independent and dependent variables are related. The advice relates to the strategy the researcher used to complete the questionnaire. Respondents are required to fill out the questionnaire's information in order for the researcher to receive positive survey findings. This study demonstrates how psychological, environmental, and intrinsic factors affect students at Universiti Malaysia Kelantan (UMK) Kampus Kota's participation in physical activity.

## REFERENCES

- Abdullah, M. F., Pilus, A. M., Razak, M. R. A., Bakar, A. Y. A., & Nazarudin, M. N. (2021). The Intrinsic and Extrinsic Motivation towards Physical Activity among Malaysian Technical University (UTeM) Students. *International Journal of Human Movement and Sports Sciences*, 9(2), 375–382. <https://doi.org/10.13189/saj.2021.090227>
- Akter, M., Sadekin, M. N., & Patwary, A. K. (2020). An Empirical Study on Students' Satisfaction from Mawlana Bhashani Science & Technology University, Bangladesh. *Review of Economics and Development Studies*, 6(2), 363-379.
- Alom, S., Patwary, A. K., & Khan, M. M. H. (2019). Factors affecting the turnover intention of Bangladeshi migrants in the United Arab Emirates: An empirical study on the hotel industry. *International Journal of Innovation, Creativity and Change*, 8(3), 344-360.
- Biddle, J. (2018, May 3). *What environmental factors affect health?* Environmental Health Sciences Center. <https://environmentalhealth.ucdavis.edu/communities/what-environmental-factors-affect-health>
- Blair, S. N., Kohl, H. W., Gordon, N. F., & Paffenbarger, R. S. (1992). How Much Physical Activity is Good for Health? *Annual Review of Public Health*, 13(1), 99–126. <https://doi.org/10.1146/annurev.pu.13.050192.000531>
- Coalter, F. (2005). The Social Benefits of Sport an Overview to Inform the Community Planning Process. *Environmental Factors in Exercise and Sports Performance - The Sport Information Resource Centre*. (2019, November 7). The Sport Information Resource Centre. <https://sirc.ca/blog/environmental-factors-in-exercise-and-sports-performance/>
- Fengmin, Z., Baijun, W., Jiangtao, B., Li, L., & Patwary, A. K. (2022). Investigating revisit intention of medical tourists in China through nutritional knowledge, perceived medical quality, and trust in the physiologist: A recommendation on health tourism policy measures. *Frontiers in Public Health*, 10, 893497.
- Fleshner, F. (2005). Physical activity and stress resistance: sympathetic nervous system adaptations prevent stress-induced immunosuppression. *Exercise and sport sciences reviews*, 33(3), 120-126.
- Hamed Taherdoost, 2016. Sampling Methods in Research Methodology; How to Choose a Sampling Technique for Research, *Journal of Academic Research in Management (IJARM)*, 5(2), 18-27
- Hazbar, A. M. H., Alem Mohammed, A., & Karim, A. K. A. (2019). An Empirical Study of Factors Influencing hotel customers' online booking Intention. *مجلة العلوم التربوية و الدراسات الإنسانية*, (5), 1-17. <https://www.studysmarter.co.uk/explanations/marketing/marketing-information-management/research-instrument/>
- Humpel, N. (2002). Environmental factors associated with adults' participation in physical activity A review. *American Journal of Preventive Medicine*, 22(3), 188–199. [https://doi.org/10.1016/s0749-3797\(01\)00426-3](https://doi.org/10.1016/s0749-3797(01)00426-3)
- Li, L., Ragavan, N. A., Patwary, A. K., & Baijun, W. (2022). Measuring patients' satisfaction toward health tourism in Malaysia through hospital environment, nutritional advice, and perceived value: A study on Chinese exchange students. *Frontiers in public health*, 10, 893439.
- Li, L., Wu, B., & Patwary, A. K. (2022). How marine tourism promote financial development in sustainable economy: new evidences from South Asia and implications to future tourism students. *Environmental Science and Pollution Research*, 29, 1155-1172.

- Li, L., Wu, B., & Patwary, A. K. (2022). The psychosocial factors affecting chinese Outbound Exchange and mobility students' academic performance during COVID-19. *Frontiers in psychology*, 13, 872516.
- Majeed NA, Jabbar MA, Jun XC. Social cognitive factors associated with physical activity among university students: a cross-sectional study. *MOJ Yoga Physical Ther.* 2017;2(2):50-55. DOI: 10.15406/mojypt.2017.02.00017
- Martins, J., Torres, B., Cardoso, J., Costa, A. M., & Honório, S. (2015). Influence of sociological aspects on the level of physical activity in physical education students. *Rua.ua.es*. <https://doi.org/1988-5202>
- Miles, L. (2007). Physical activity and health. *Nutrition Bulletin*, 32(4), 314–363. <https://doi.org/10.1111/j.1467-3010.2007.00668.x>
- Muth J L, Cash T F. Bodyimage attitudes: What difference does gender make? *Journal of Applied Social Psychology*, 1997, 27(16):1438-1452.
- Normaizatul Akma Saidi, S. F. (2019). NURTURING , HOSPITALITY, TOURISM AND
- Patwary, A. K., Roy, B., Hoque, R., & Khandakar, M. S. A. (2019). Process of developing a community based tourism and identifying its economic and social impacts: An Empirical study on Cox's Bazar, Bangladesh. *Pakistan Journal of Humanities and Social Sciences*, 7(1), 1-13.
- Research Instrument. (2022). *Research Instrument: Meaning & Examples | StudySmarter*. StudySmarter UK.
- Schultchen, D., Reichenberger, J., Mittl, T., Weh, T. R., Smyth, J. M., Blechert, J., & Pollatos, O. (2019). Bidirectional relationship of stress and affect with physical activity and healthy eating. *British journal of health psychology*, 24(2), 315-333.
- Sumethokula, P., Patwary, A. K., Srinuanpanc, B., Srinuanpand, C., Suwandee, P., Thammathikul, A., & Phanong, W. (2020). The potential of new tour repackaging for creative tourism among entrepreneurs in Nakhon Si Thammarat. *International Journal of Innovation, Creativity and Change*, 13(10), 1752-1771.
- Turner, Dana P. (2020). Sampling Methods in Research Design. *Headache: The Journal of Head and Face Pain*, 60(1), 8–12. <https://doi.org/10.1111/head.13707>
- WELLNESS WORLD. <http://myscholar.umk.edu.my/bitstream/123456789/1473/1/E-PROCEEDING%20WELLNESS-VOLUME%203.pdf#page=48>
- World. (2022, October 5). *Physical activity*. Who.int; World Health Organization: WHO. <https://www.who.int/news-room/fact-sheets/detail/physical-activity>
- World. (2022, October 5). *Physical activity*. Who.int; World Health Organization: WHO. <https://www.who.int/news-room/fact-sheets/detail/physical-activity>.
- Wu, B., Liu, S., Wang, J., Tahir, S., & Patwary, A. K. (2021). Assessing the mechanism of energy efficiency and energy poverty alleviation based on environmental regulation policy measures. *Environmental Science and Pollution Research*, 28, 40858-40870.
- Wu, B., Zhai, B., Mu, H., Peng, X., Wang, C., & Patwary, A. K. (2021). Evaluating an economic application of renewable generated hydrogen: A way forward for green economic performance and policy measures. *Environmental Science and Pollution Research*, 1-33.



